



US00D776948S

(12) **United States Design Patent** (10) **Patent No.:** **US D776,948 S**
Weng (45) **Date of Patent:** **** Jan. 24, 2017**

(54) **WOODEN HAMMOCK**

(71) Applicant: **Ningbo Mentoriend International Trading Co., Ltd.**, Ningbo (CN)
(72) Inventor: **Johnson Weng**, Ningbo (CN)
(73) Assignee: **NINGBO MENTORIEND INTERNATIONAL TRADING CO., LTD.**, Ningbo (CN)

(**) Term: **15 Years**

(21) Appl. No.: **29/558,196**

(22) Filed: **Mar. 15, 2016**

(51) **LOC (10) Cl.** **06-01**

(52) **U.S. Cl.**
USPC **D6/347; D6/387**

(58) **Field of Classification Search**
USPC D6/385, 386, 387, 344, 346, 347
CPC A45F 3/22; A45F 3/24; A45F 3/26;
A47C 17/64; A47C 17/84; A47D 9/02
See application file for complete search history.

(56) **References Cited**

U.S. PATENT DOCUMENTS

281,216 A *	7/1883	White	A63G 9/02
				297/245
D362,757 S *	10/1995	Sayih	D6/333
D364,969 S *	12/1995	Boone	D6/344
D677,914 S *	3/2013	Cardenas	D6/347

OTHER PUBLICATIONS

Hammock Chair Stand, Pinterest, "5 years ago," site visited Nov. 8, 2016, available online: <URL:https://www.pinterest.com/pin/57632070201062292/>.*
Hammock Chair Stand, Pinterest, "2 years ago," site visited Nov. 8, 2016, available online: <URL:https://www.pinterest.com/pin/410601690999716185/>.*
Wooden Hammock Chair, Pinterest, "2 years ago," site visited Nov. 8, 2016, available online: <URL: https://www.pinterest.com/pin/410601690999716280/>.*
Wooden Swing Chair, Comfurn The Indoor World, Indiamart, site visited Nov. 3, 2016, available online: <URL:http://dir.indiamart.com/impcat/wooden-swing-chair.html>.*

* cited by examiner

Primary Examiner — Cathron Brooks
(74) *Attorney, Agent, or Firm* — Matthias Scholl, PC; Matthias Scholl

(57) **CLAIM**

The ornamental design for a wooden hammock, as shown and described.

DESCRIPTION

FIG. 1 is a front elevational view of a wooden hammock; FIG. 2 is a rear elevational view thereof; FIG. 3 is a left side elevational view thereof; FIG. 4 is a right side elevational view thereof; FIG. 5 is a top plan view thereof; FIG. 6 is a bottom plan view thereof; and, FIG. 7 is a perspective view thereof.

1 Claim, 7 Drawing Sheets

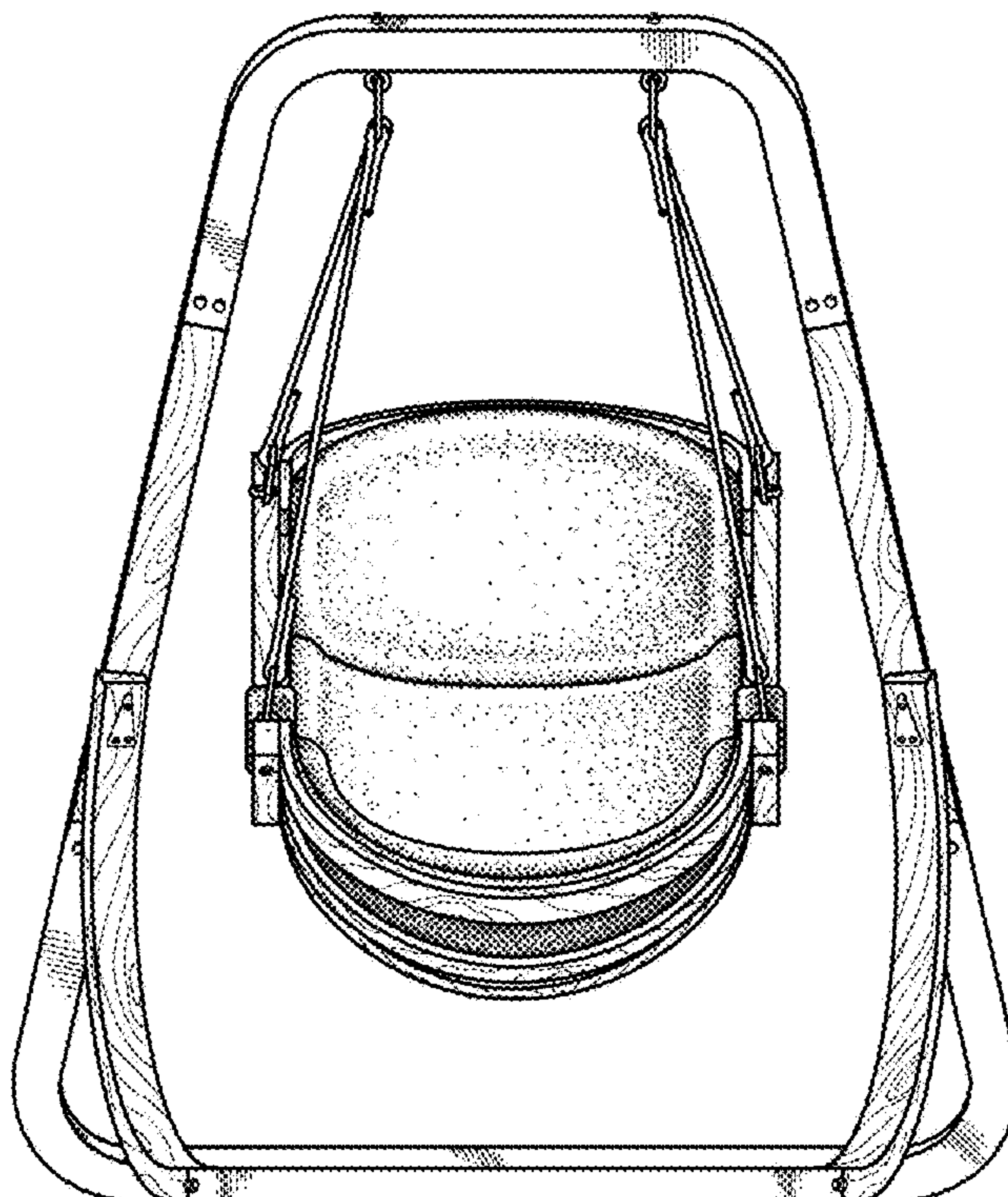

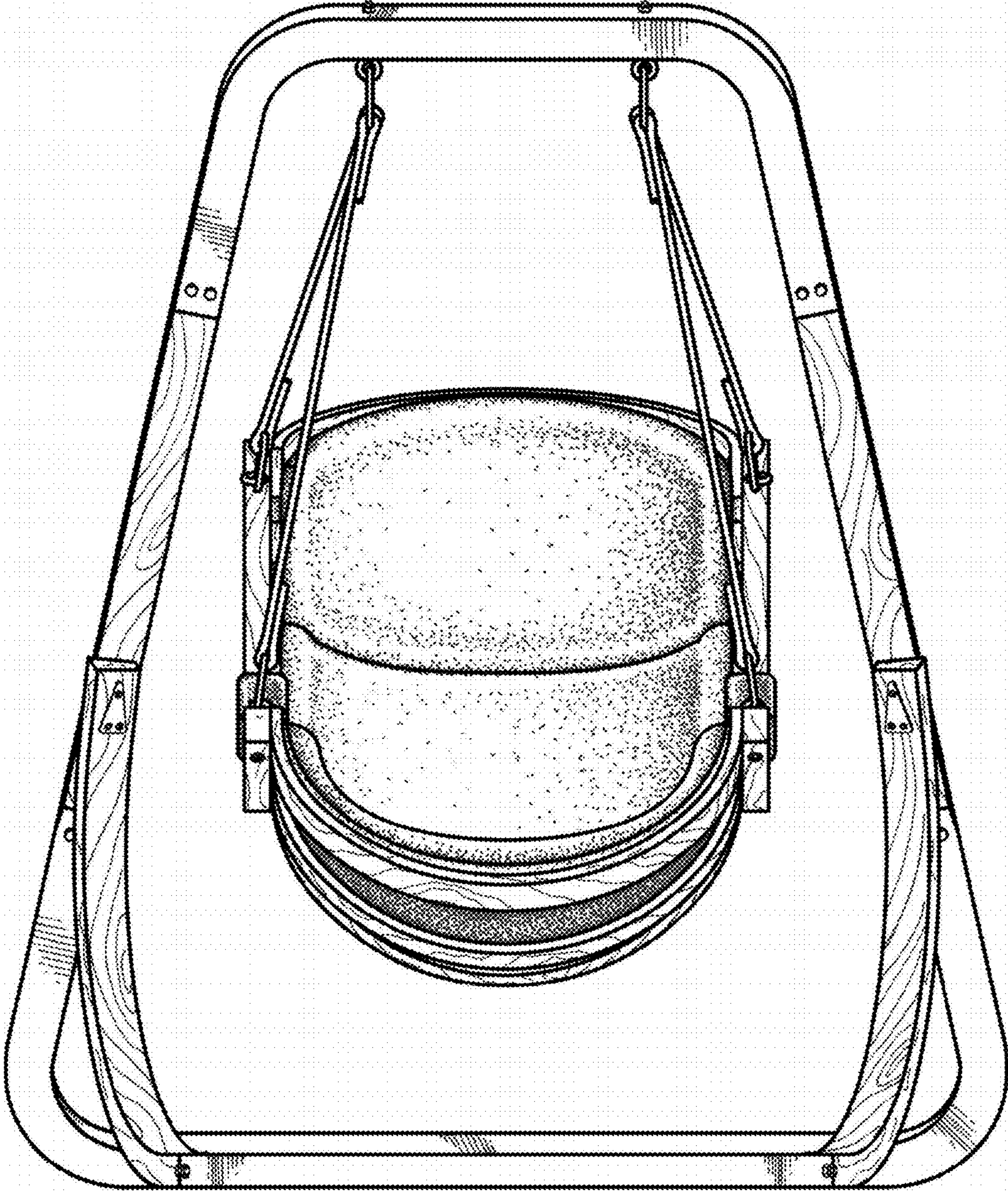

FIG. 1

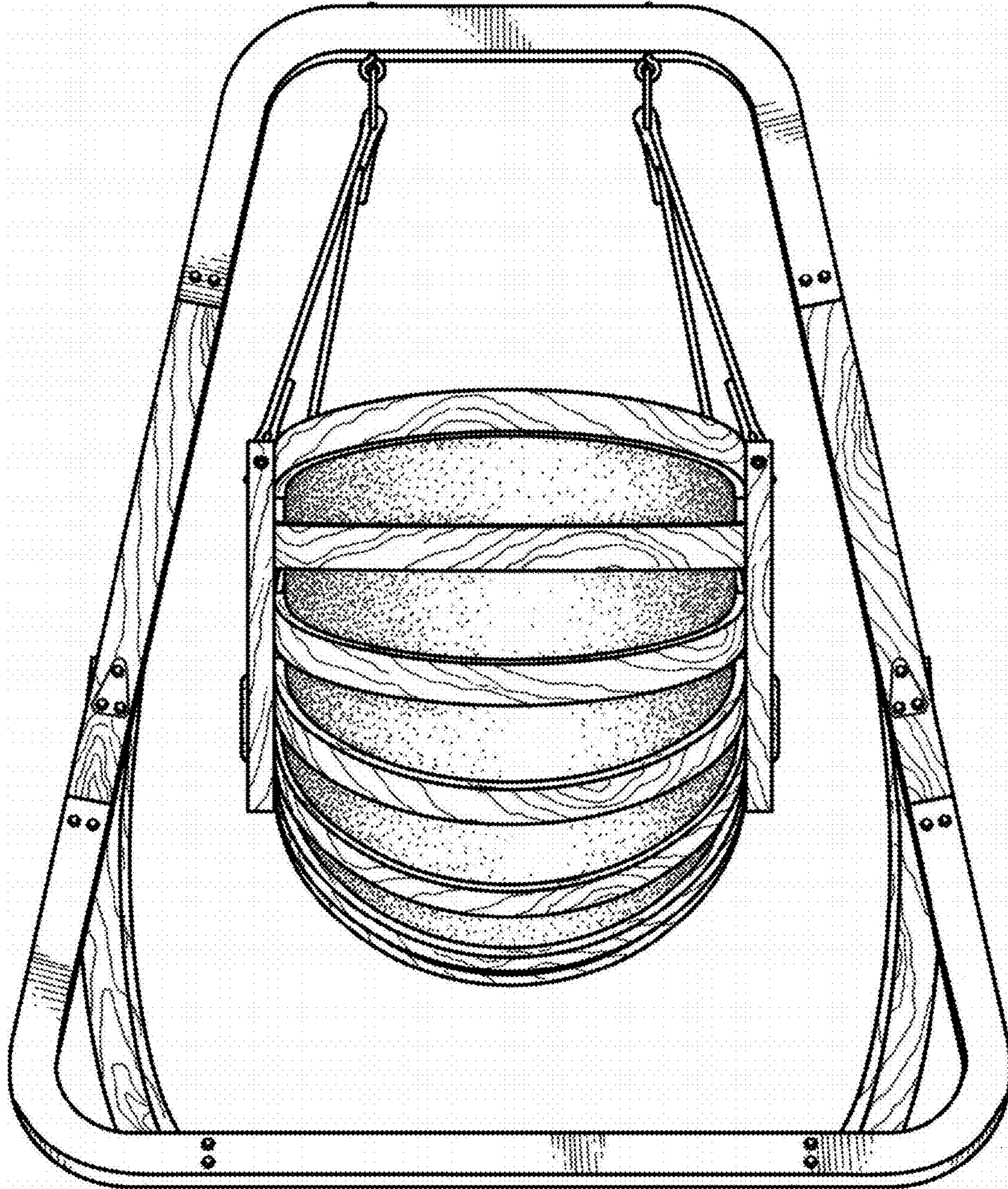

FIG. 2

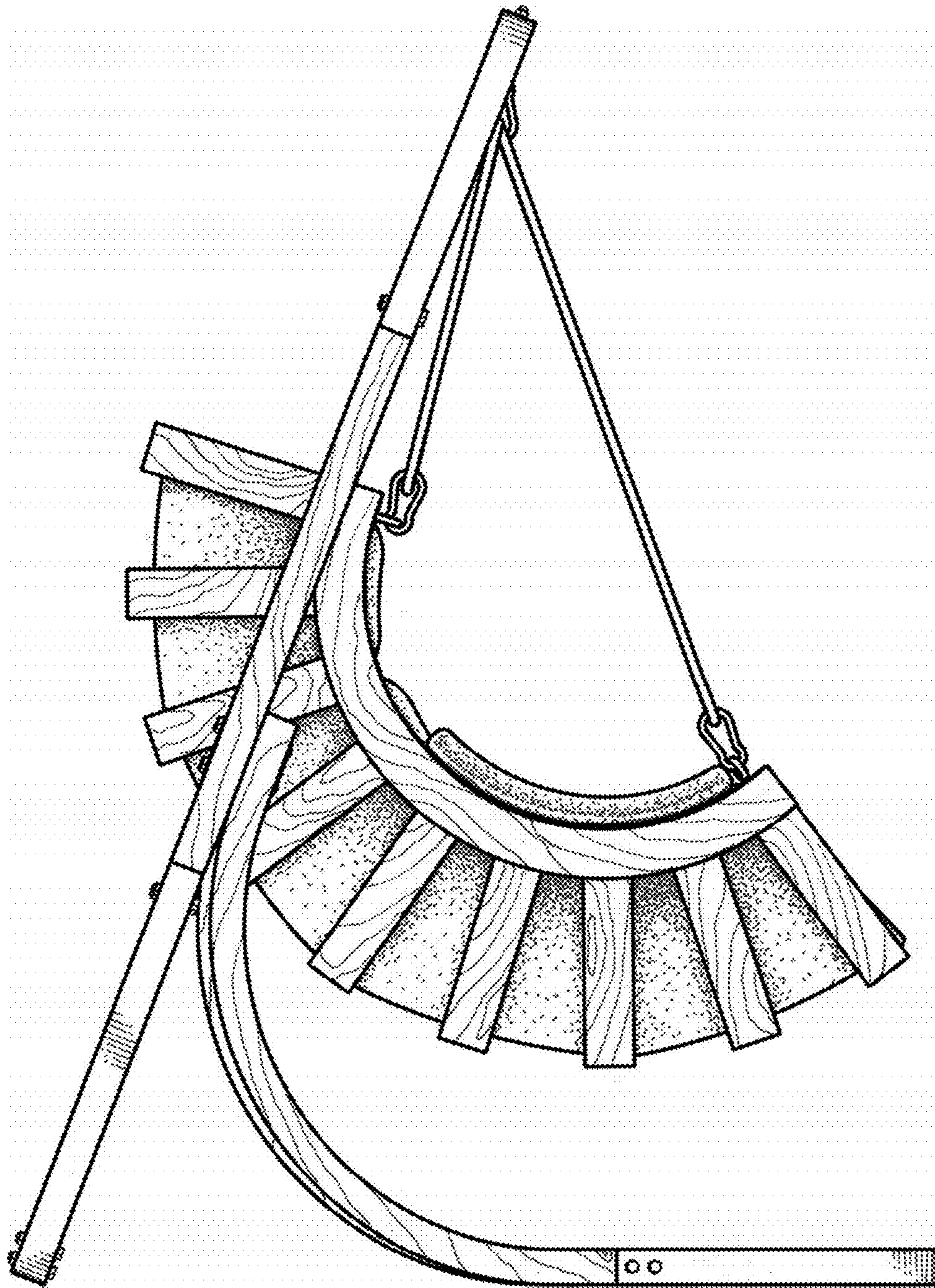

FIG. 3

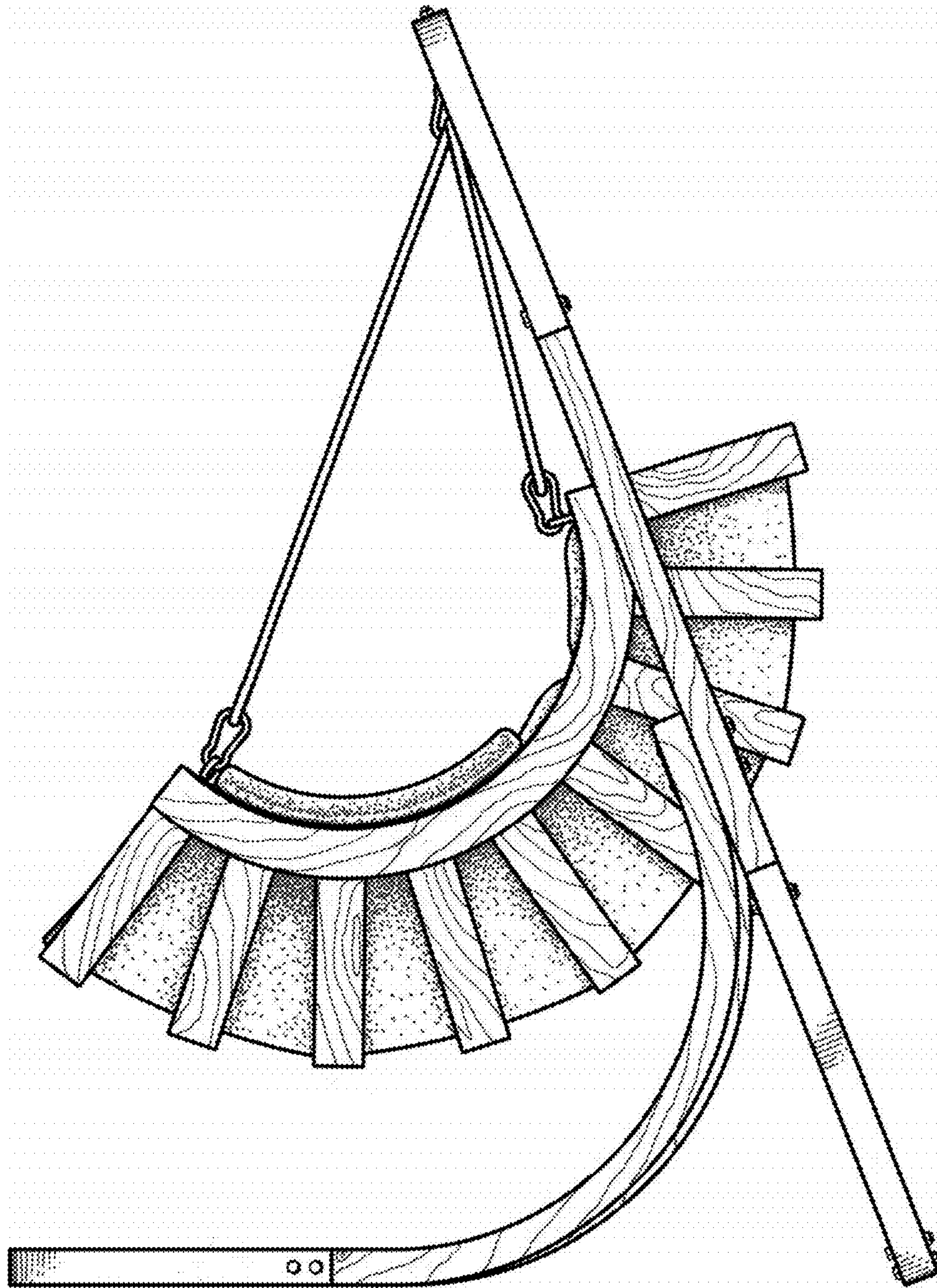

FIG. 4

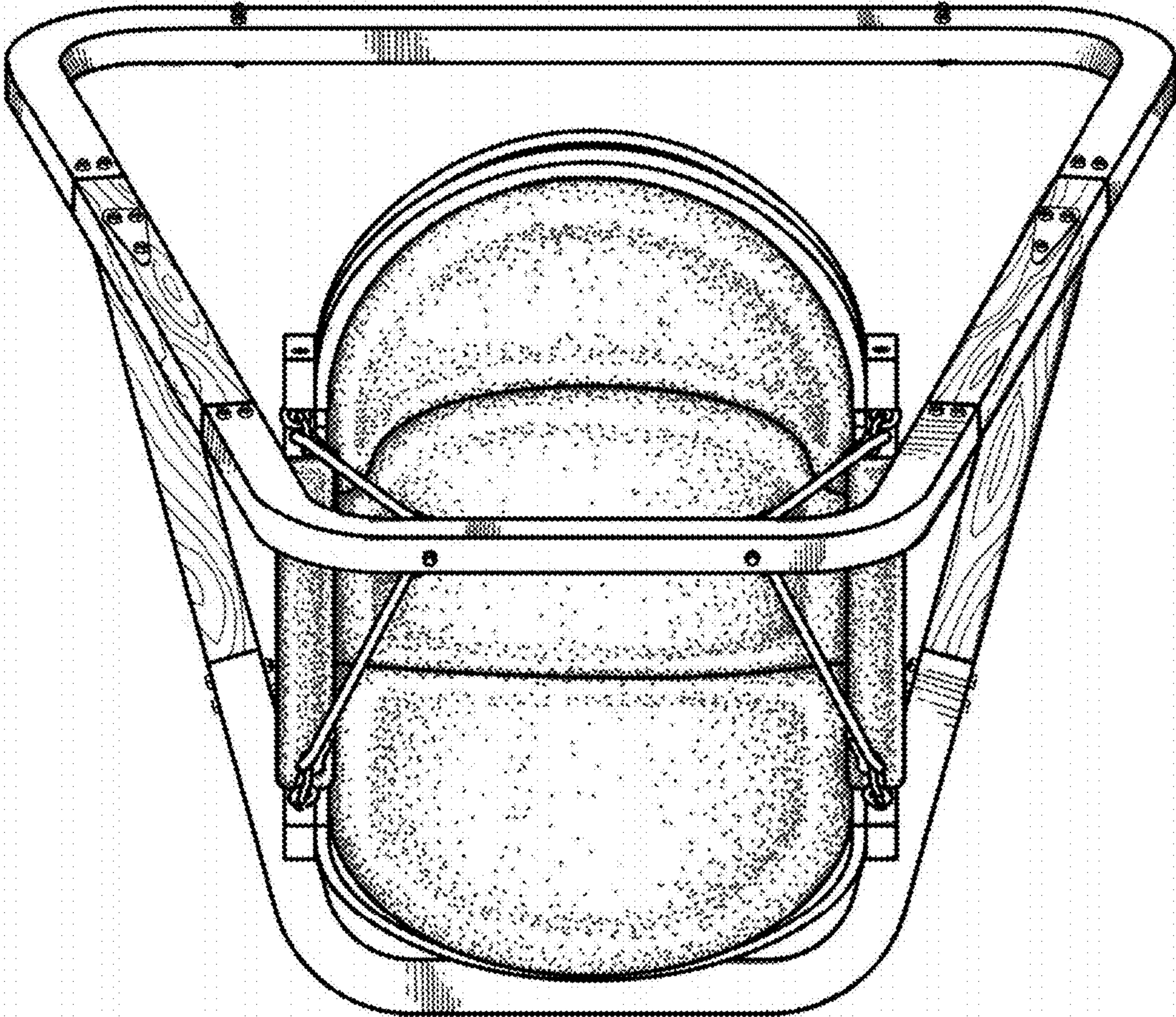

FIG. 5

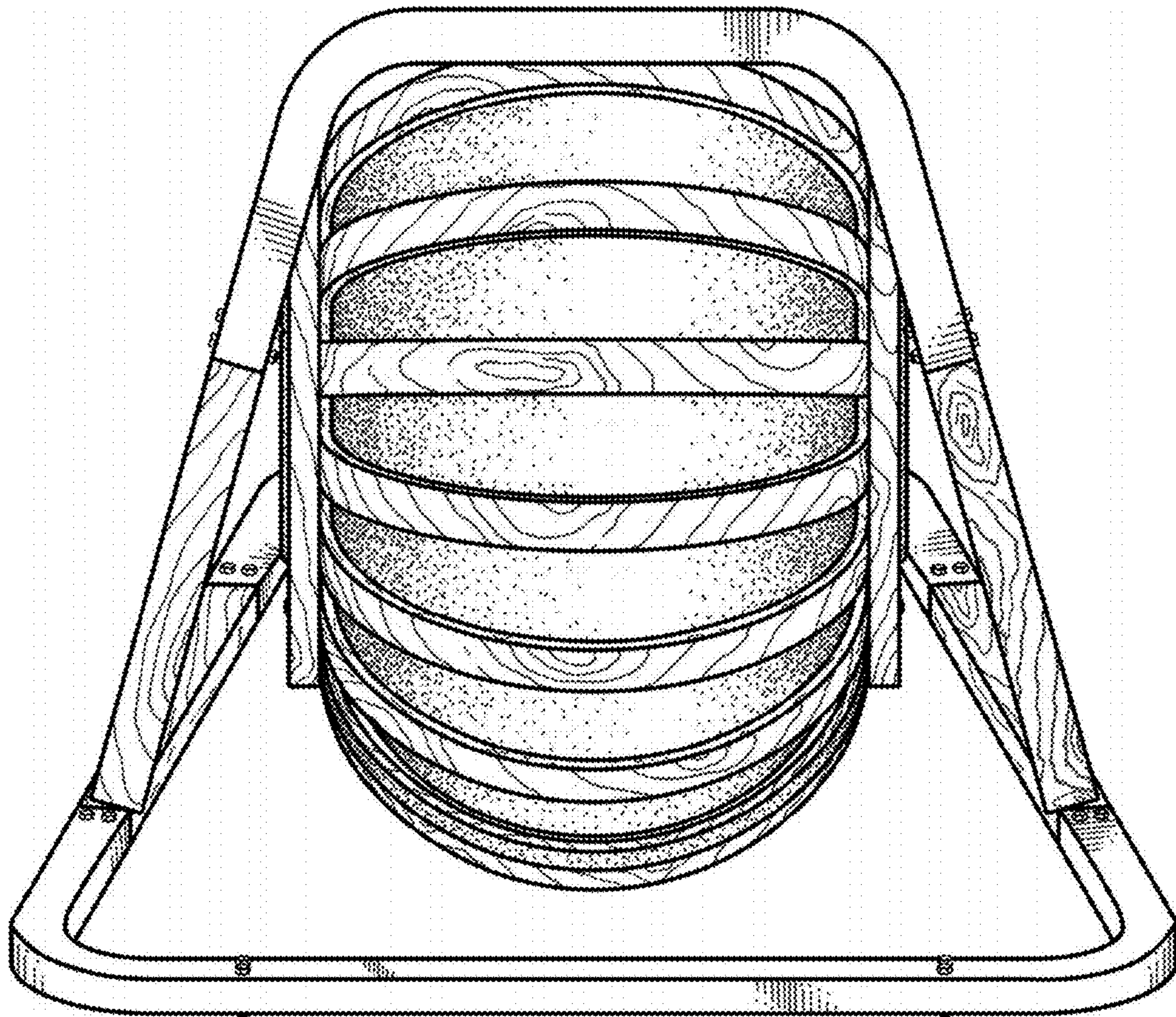

FIG. 6

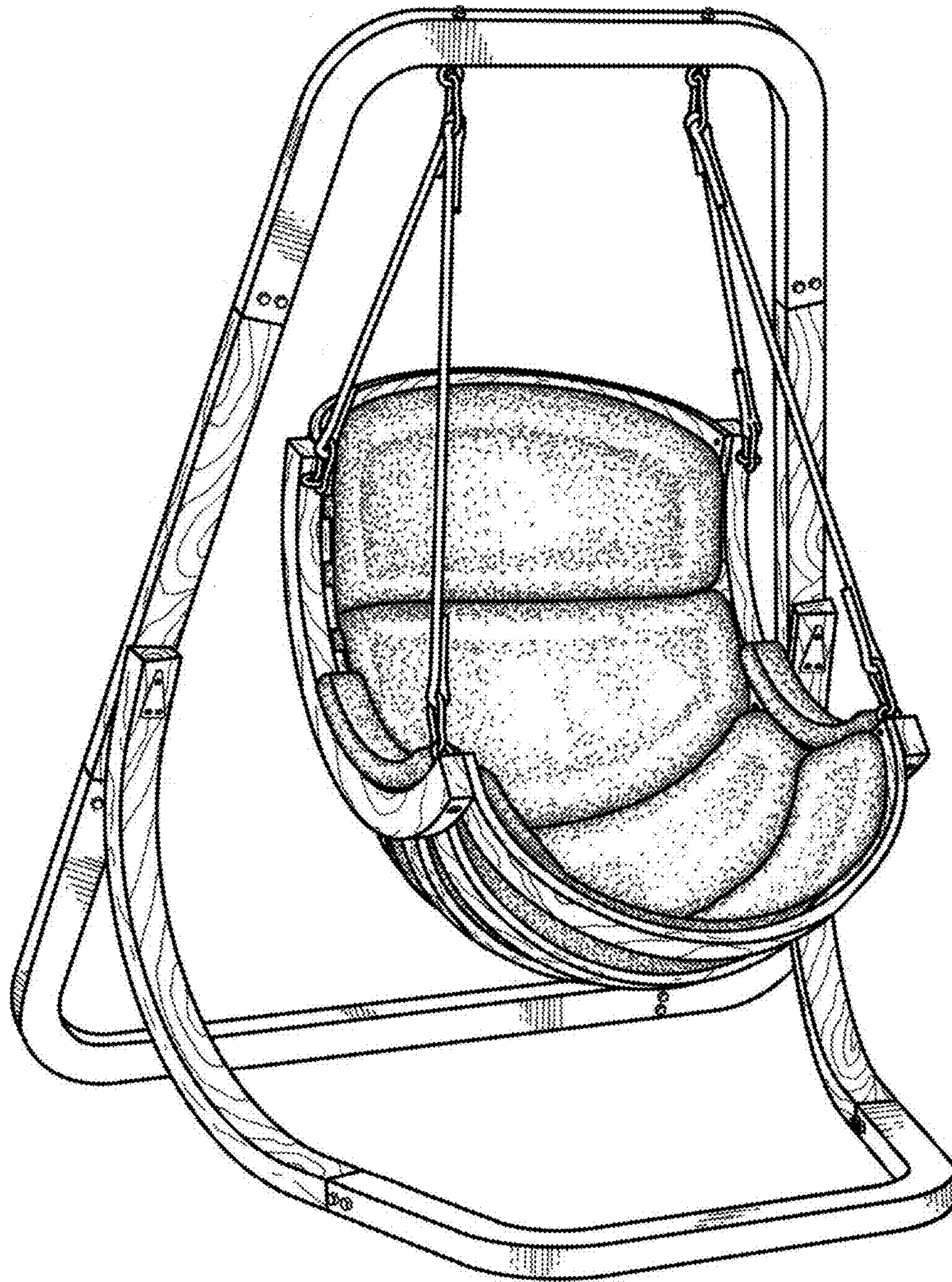

FIG. 7