



US00D776908S

(12) **United States Design Patent** (10) **Patent No.:** **US D776,908 S**  
**Arnold** (45) **Date of Patent:** **\*\* Jan. 24, 2017**

(54) **FOOTWEAR UPPER**

(71) Applicant: **Deckers Outdoor Corporation**, Goleta, CA (US)

(72) Inventor: **Elizabeth Arnold**, London (GB)

(73) Assignee: **Deckers Outdoor Corporation**, Goleta, CA (US)

(\*\*) Term: **15 Years**

(21) Appl. No.: **29/545,344**

(22) Filed: **Nov. 12, 2015**

(51) **LOC (10) Cl.** ..... **02-04**

(52) **U.S. Cl.**  
USPC ..... **D2/970**

(58) **Field of Classification Search**  
USPC ..... D2/896, 900, 909-911, 943, 946, 969, D2/970, 974  
CPC ..... A43B 7/12; A43B 5/004; A43B 3/02; A43B 23/02  
See application file for complete search history.

(56) **References Cited**

**U.S. PATENT DOCUMENTS**

D122,454 S *	9/1940	Ascheim .....	D2/911
D136,965 S *	1/1944	Wharton .....	D2/911
D581,646 S	12/2008	Le	
D706,526 S	6/2014	Mentha	
D727,611 S	4/2015	Dillenbeck	
D738,604 S	9/2015	Deas	
D762,371 S *	8/2016	McClaskie .....	D2/970
D762,956 S *	8/2016	McClaskie .....	D2/943

**OTHER PUBLICATIONS**

“Stivaletti: tutte le tendenze della p/e 2015”, www.girlpower.it, Apr. 21, 2015, see <http://www.girlpower.it/look/tendenze/stivaletti-estivi-tendenze-2015.php>.  
Rag and Bone, Moto Boot, www.Nordstrom.com, Oct. 7, 2012, see [http://shop.nordstrom.com/s/rag-bone-moto-boot/3334344?cm\\_](http://shop.nordstrom.com/s/rag-bone-moto-boot/3334344?cm_)

mmc=Google\_Product\_Ads\_pla\_online-\_-datafeed-\_-women%3Ashoes%3Aboots-\_-576371&amp;%3Bcountry=US& amp%3Bcurrency=USD&mr%3AreferralID=e5b33615-9eb2-11e5-b82d-00505694526f&gclid=CL3GqpLOz8kCFQ-RaQod-dQgCEA.  
River Island Jennie Cut Out Ankle Boots, www.femalefirst.co.uk, “Ankle boots under 40”, Oct. 9, 2014, see <http://www.femalefirst.co.uk/lifestyle-fashion/styletrends/ankle-boots-for-autumn-fashion-347359.html>.  
Free People Braeburn Bootie, www.Nordstrom.com, Sep. 15, 2014, see [http://shop.nordstrom.com/s/free-people-braeburn-bootie-women/3790068?cm\\_mmc=Google\\_Product\\_Ads\\_pla\\_online-\\_-datafeed-\\_-women%3Ashoes%3Aboots-\\_-466899& amp%3Bcountry=US&amp%3Bcurrency=USD& mr%3AreferralID=3274e3a3-9eb1-11e5-b0f7-0050569451e5& qlid=CL\\_9p7XLz8kCFQanaQodphgCvA](http://shop.nordstrom.com/s/free-people-braeburn-bootie-women/3790068?cm_mmc=Google_Product_Ads_pla_online-_-datafeed-_-women%3Ashoes%3Aboots-_-466899& amp%3Bcountry=US&amp%3Bcurrency=USD& mr%3AreferralID=3274e3a3-9eb1-11e5-b0f7-0050569451e5& qlid=CL_9p7XLz8kCFQanaQodphgCvA).

\* cited by examiner

*Primary Examiner* — Ian Simmons  
*Assistant Examiner* — Rashida C Walshon  
(74) *Attorney, Agent, or Firm* — Greer, Burns & Crain, Ltd.

(57) **CLAIM**

The ornamental design for a footwear upper, as shown and described.

**DESCRIPTION**

FIG. 1 is a front perspective view of a footwear upper showing the new design;  
FIG. 2 is a side elevational view thereof;  
FIG. 3 is an opposite side elevational view thereof;  
FIG. 4 is a front elevational view thereof;  
FIG. 5 is a rear elevational view thereof;  
FIG. 6 is a top plan view thereof; and,  
FIG. 7 is a bottom plan view thereof.

The evenly spaced broken lines represent portions of the footwear that form no part of the claimed design. Further, the dash dot dash lines immediately adjacent to the solid-line portions of the design form the bounds of the design, and forms no part of the claimed design.

**1 Claim, 4 Drawing Sheets**

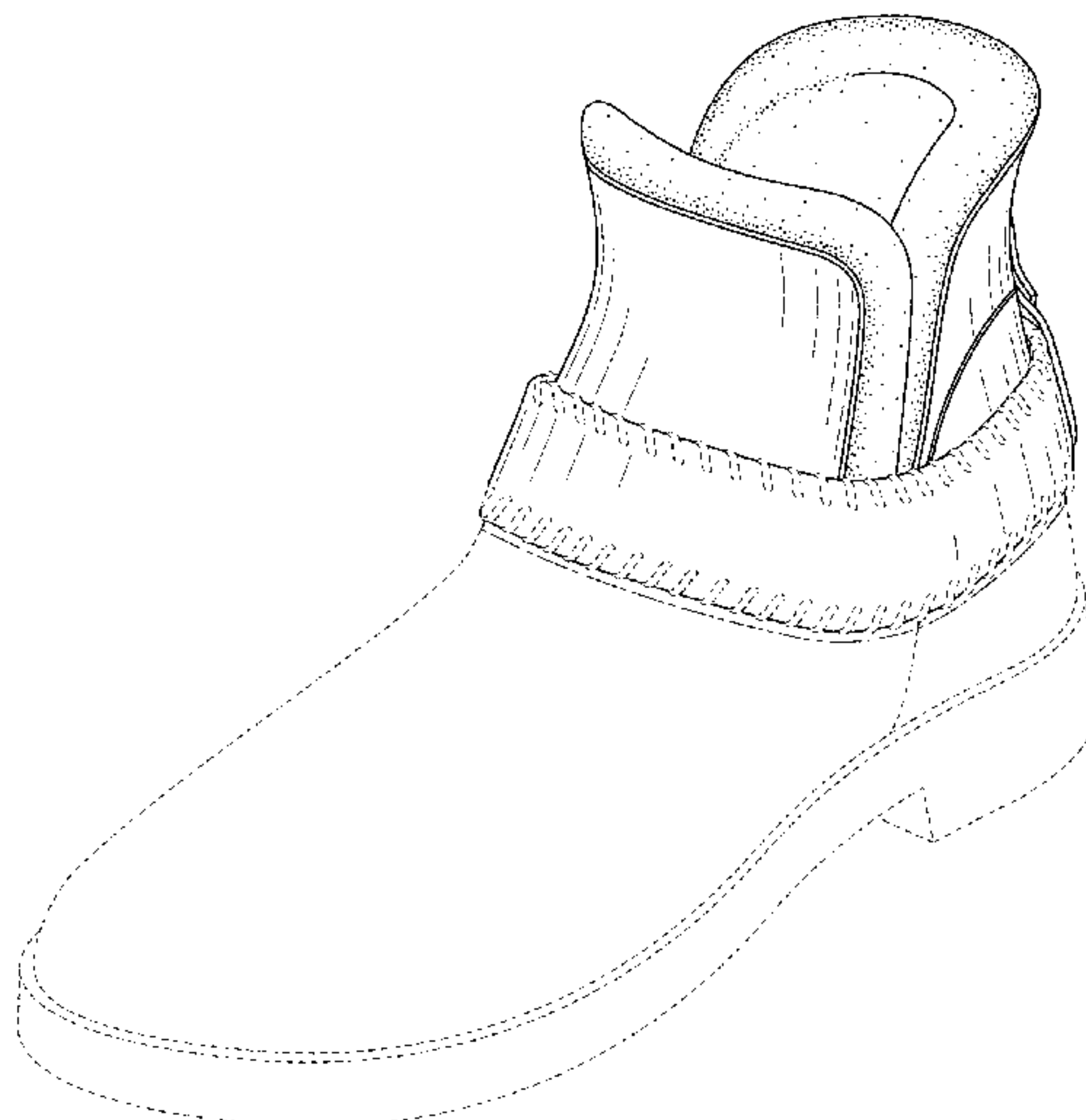

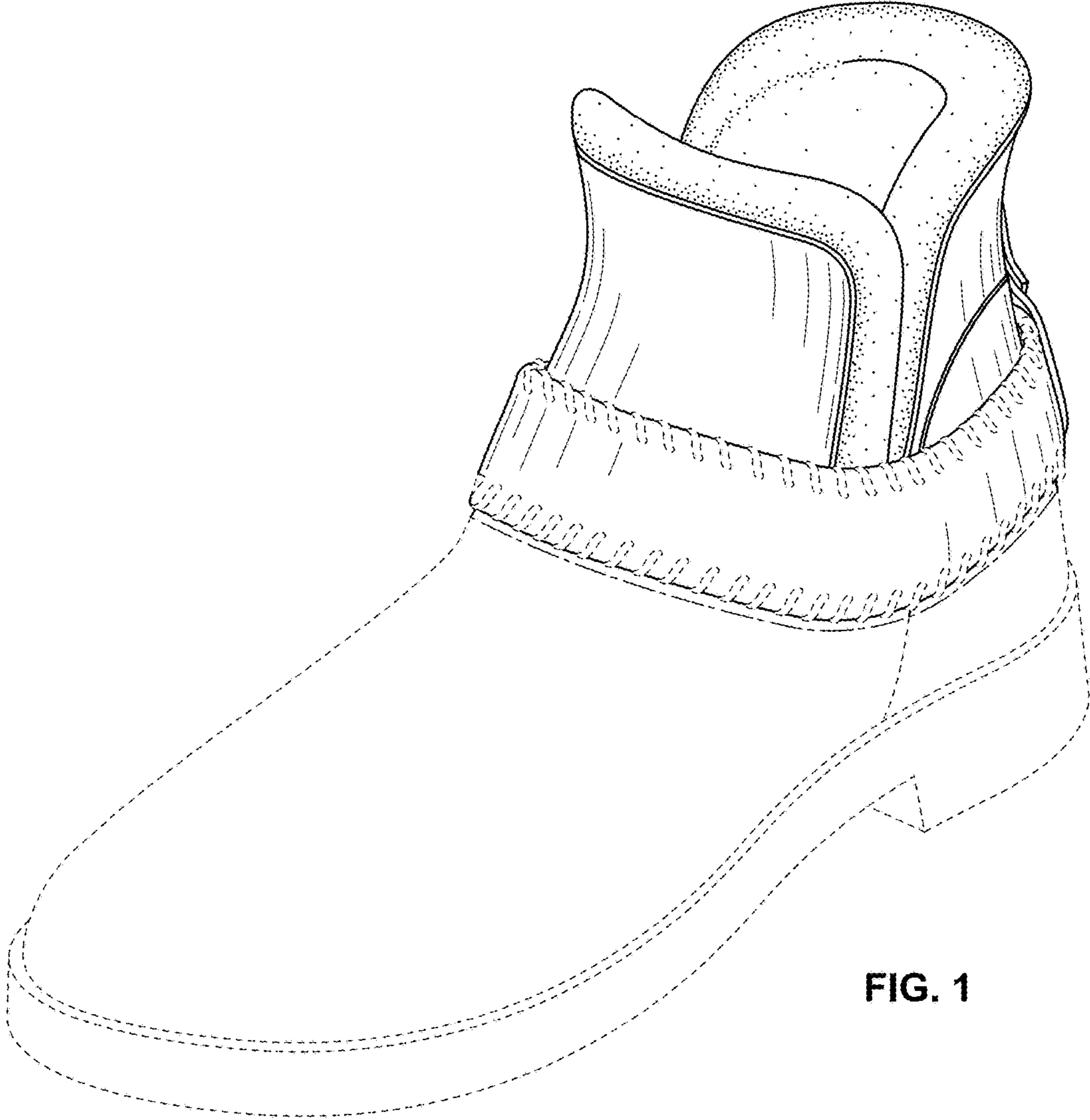

FIG. 1

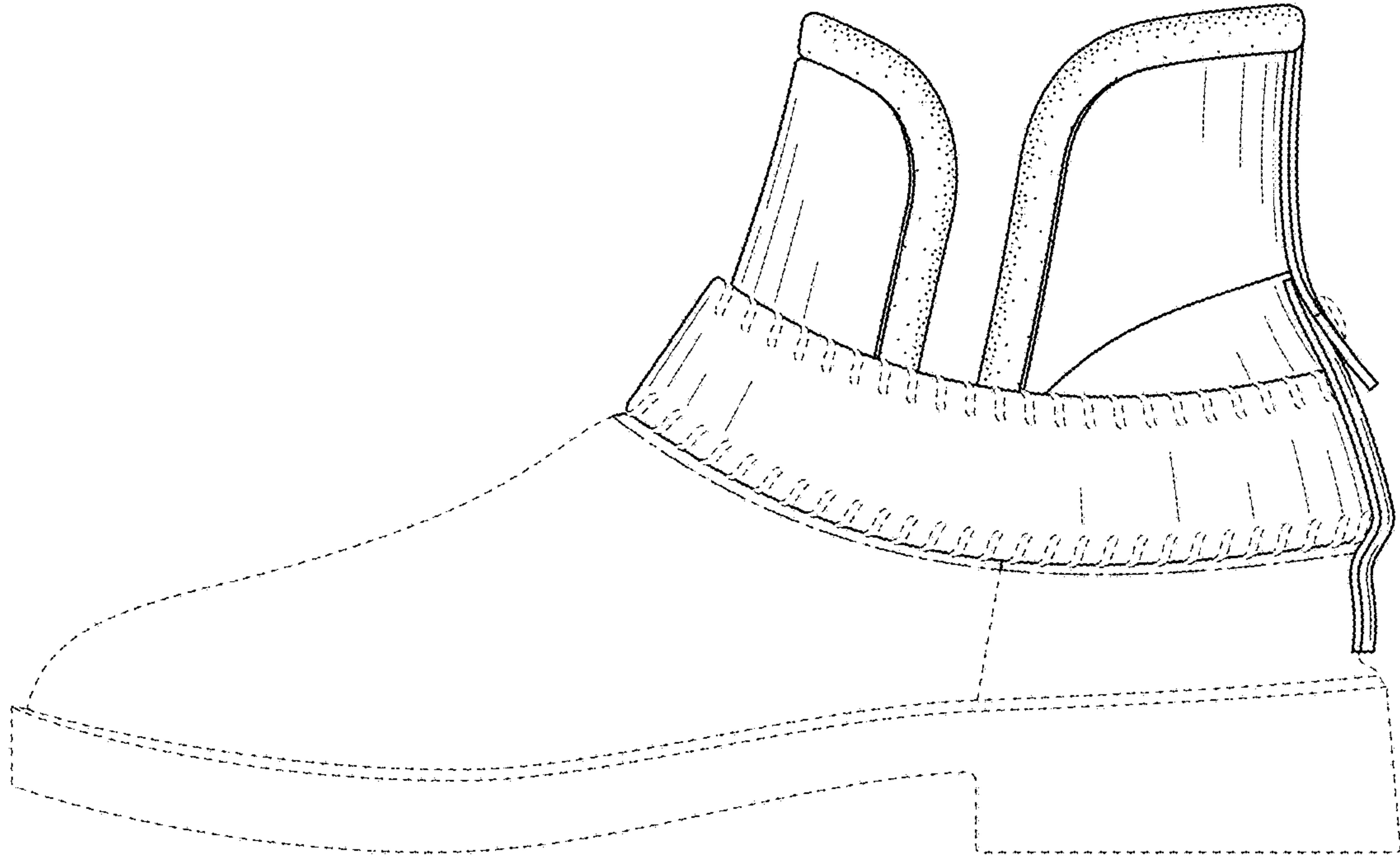

FIG. 2

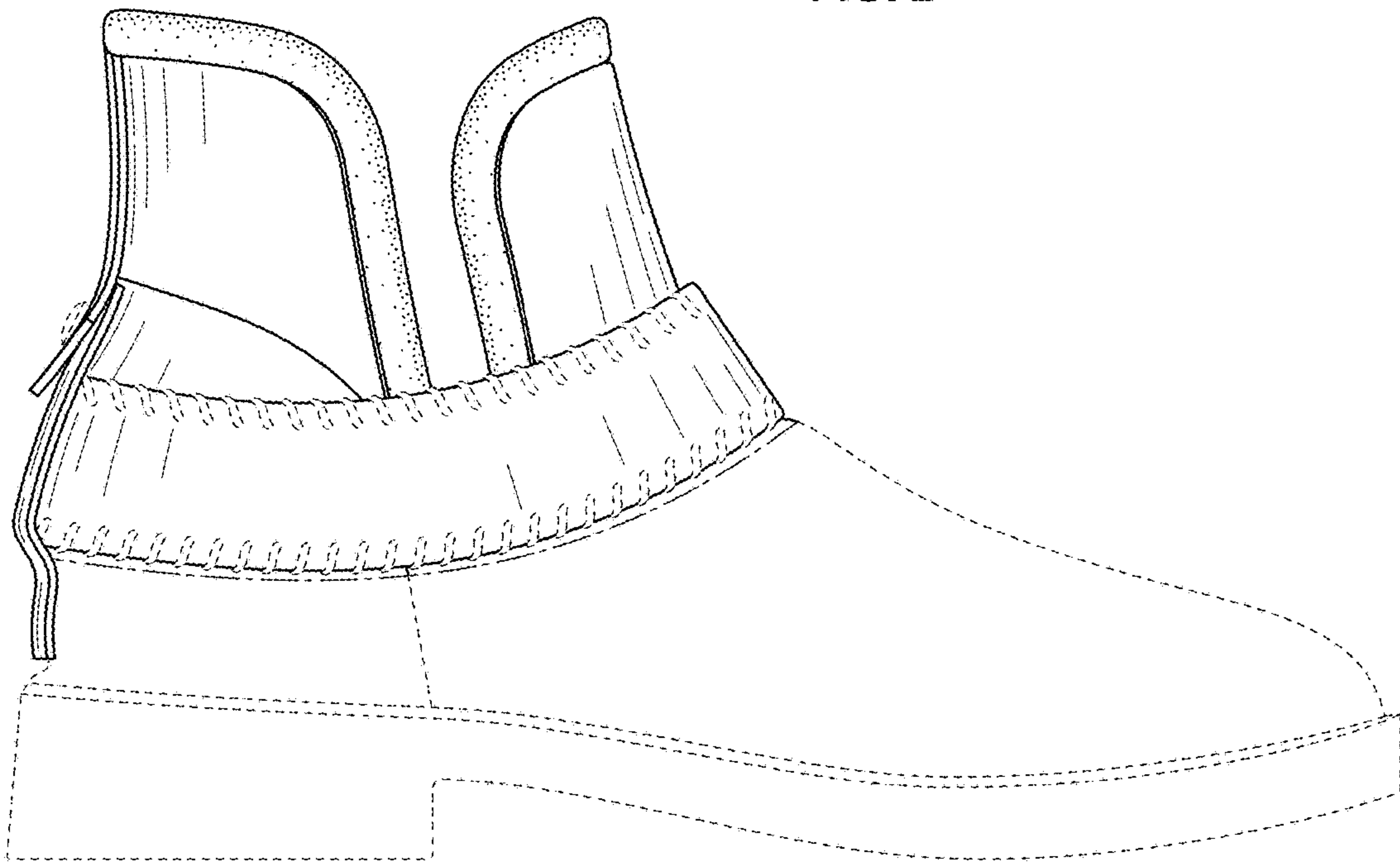

FIG. 3

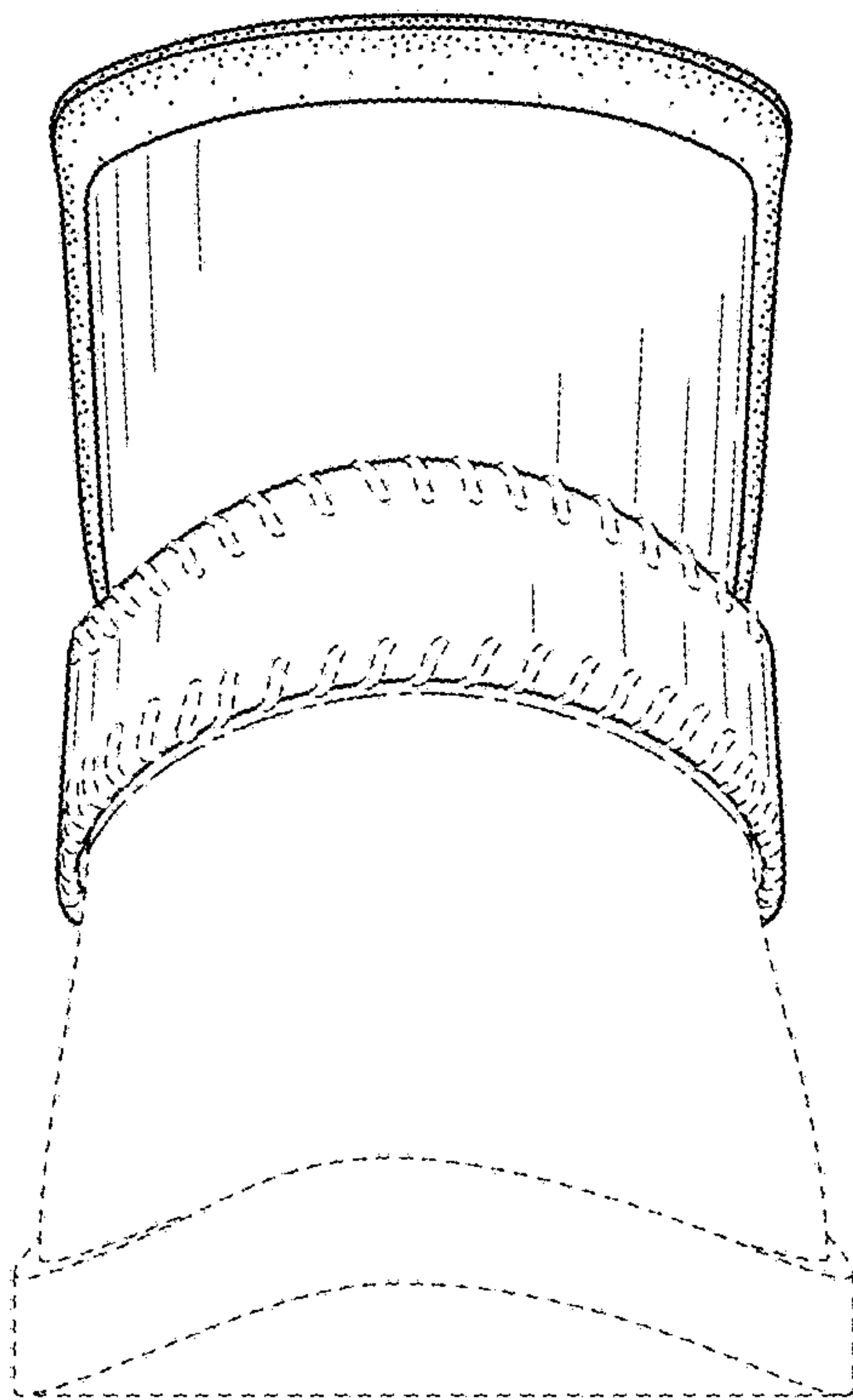

FIG. 4

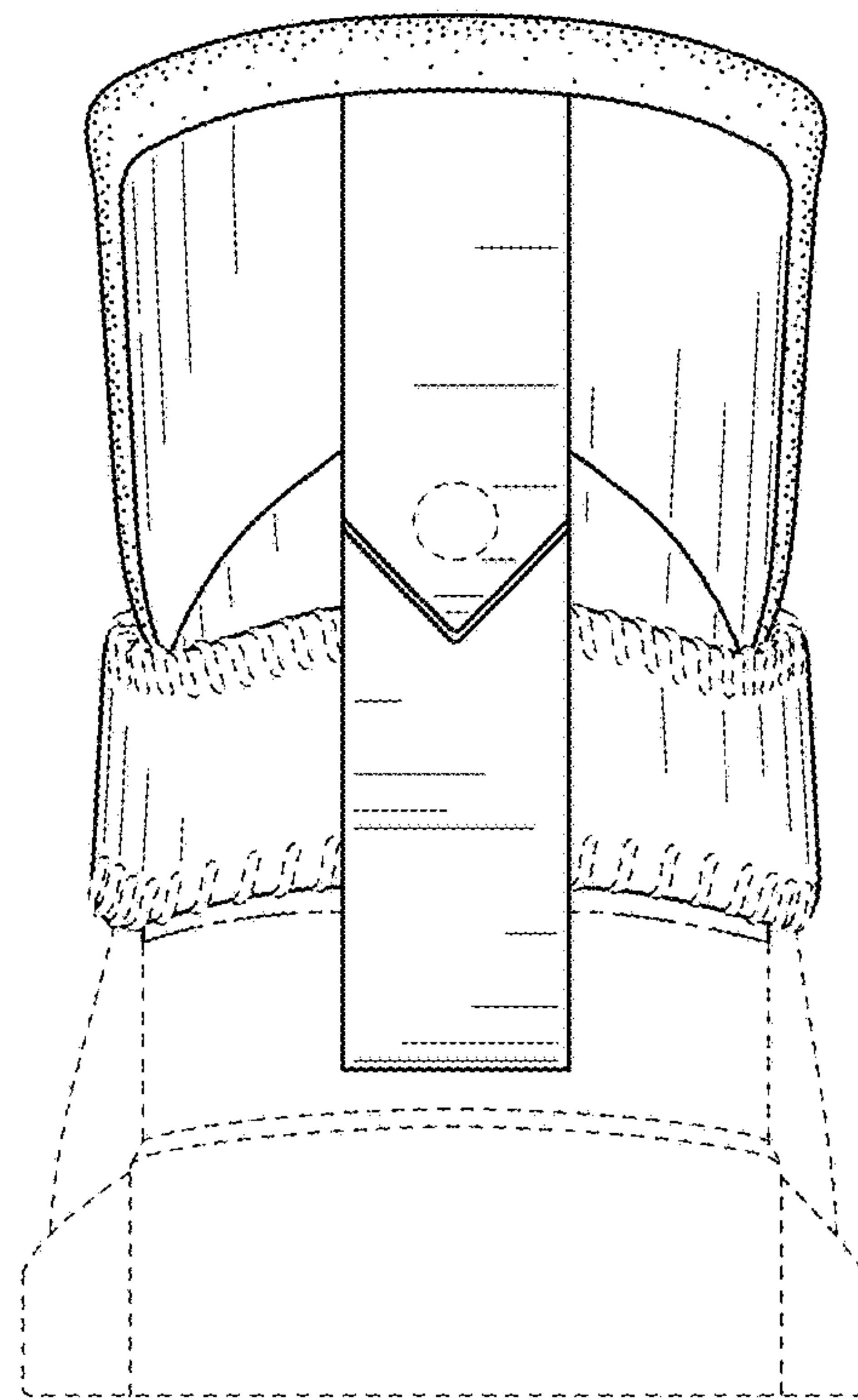

FIG. 5



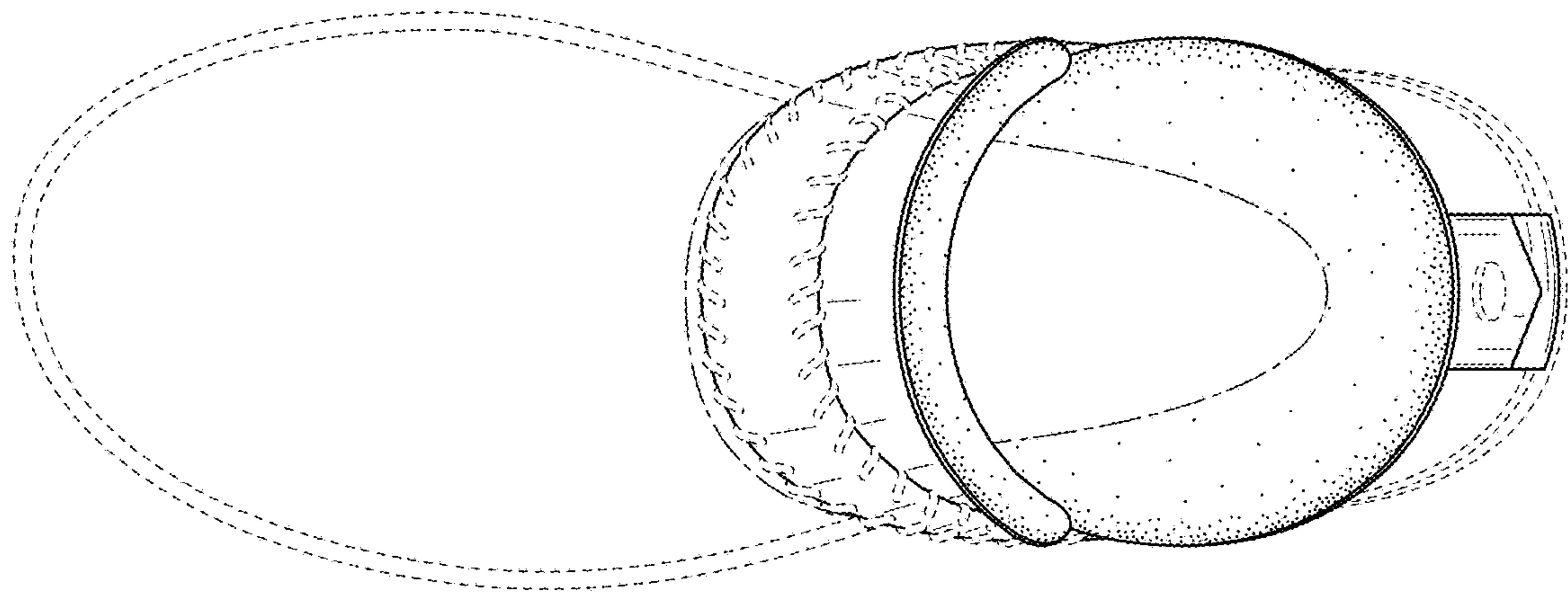

FIG. 6

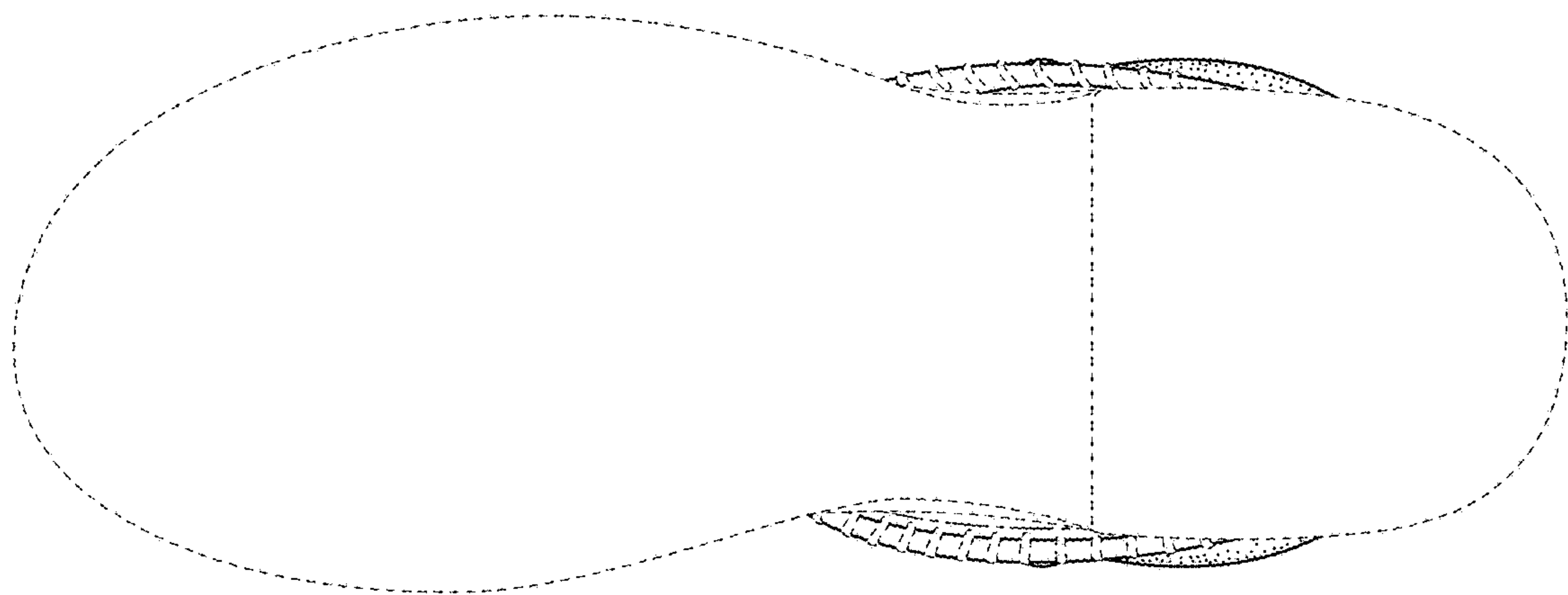

FIG. 7