



US00D776852S

(12) **United States Design Patent** (10) **Patent No.:** **US D776,852 S**
Weng (45) **Date of Patent:** **** Jan. 17, 2017**

(54) **ILLUMINATION DEVICE**
(71) Applicant: **Gogoro Inc.**, Hong Kong (CN)
(72) Inventor: **Chien-Chih Weng**, New Taipei (TW)
(73) Assignee: **GOGORO INC.**, Hong Kong (CN)
(**) Term: **14 Years**

(21) Appl. No.: **29/521,950**
(22) Filed: **Mar. 26, 2015**

(30) **Foreign Application Priority Data**
Dec. 11, 2014 (TW) 103307350
(51) **LOC (10) Cl.** **26-05**
(52) **U.S. Cl.**
USPC **D26/74**
(58) **Field of Classification Search**
USPC D26/74, 72, 75, 76, 77, 78, 85, 88, 89,
D26/118, 138, 141; 362/364, 365, 373,
362/145, 146, 147, 148, 150, 153, 153.1,
362/294, 296.01, 296.07, 296.08
CPC F21V 29/2262; F21V 7/06; F21V 21/044;
F21V 21/047; F21V 29/2212; F21V
29/2225; F21V 29/2256; F21V 29/225;
F21V 29/2268; F21Y 2111/002; F21S
8/02; F21S 8/026
See application file for complete search history.

(56) **References Cited**
U.S. PATENT DOCUMENTS
D360,042 S * 7/1995 Taylor D26/28
D411,635 S * 6/1999 Philipot D26/28
D425,225 S * 5/2000 Holderfield D26/37
D513,335 S * 12/2005 Lee D26/37

D586,028 S * 2/2009 Condon D26/72
D622,424 S * 8/2010 Smith D26/26
D639,495 S * 6/2011 Huang D26/118
D650,506 S * 12/2011 Kaule D26/72
D650,507 S * 12/2011 Osiecki D26/72
D685,943 S * 7/2013 Duquette D26/74
D687,178 S * 7/2013 Grandsart D26/85
D725,307 S * 3/2015 Guercio D26/89
D728,149 S * 4/2015 Hiller D26/89

* cited by examiner
Primary Examiner — Angela J Lee
(74) *Attorney, Agent, or Firm* — Seed IP Law Group LLP

(57) **CLAIM**
The ornamental design for an illumination device, as shown and described.

DESCRIPTION
FIG. 1 is a front perspective view of a first embodiment of an illumination device showing my new design.
FIG. 2 is a front view thereof.
FIG. 3 is a left side view thereof.
FIG. 4 is a right side view thereof.
FIG. 5 is a top plan view thereof.
FIG. 6 is a bottom plan view thereof.
FIG. 7 is a front perspective view of a second embodiment of an illumination device showing my new design.
FIG. 8 is a front view thereof.
FIG. 9 is a rear view thereof.
FIG. 10 is a left side view thereof.
FIG. 11 is a right side view thereof.
FIG. 12 is a top plan view thereof; and,
FIG. 13 is a bottom plan view thereof.
The broken lines in FIGS. 1-13 are intended to illustrate environmental structure for the claimed design and form no part of the claimed design.

1 Claim, 11 Drawing Sheets

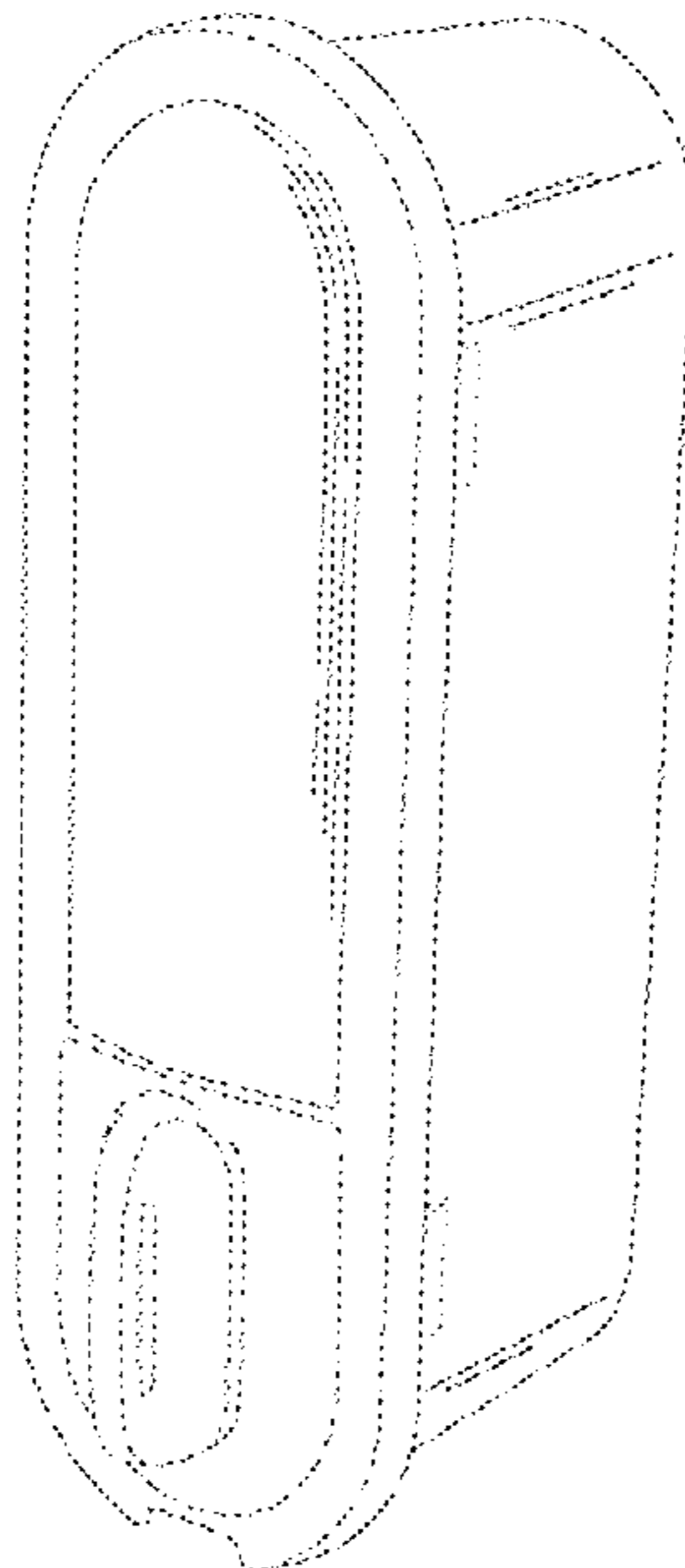

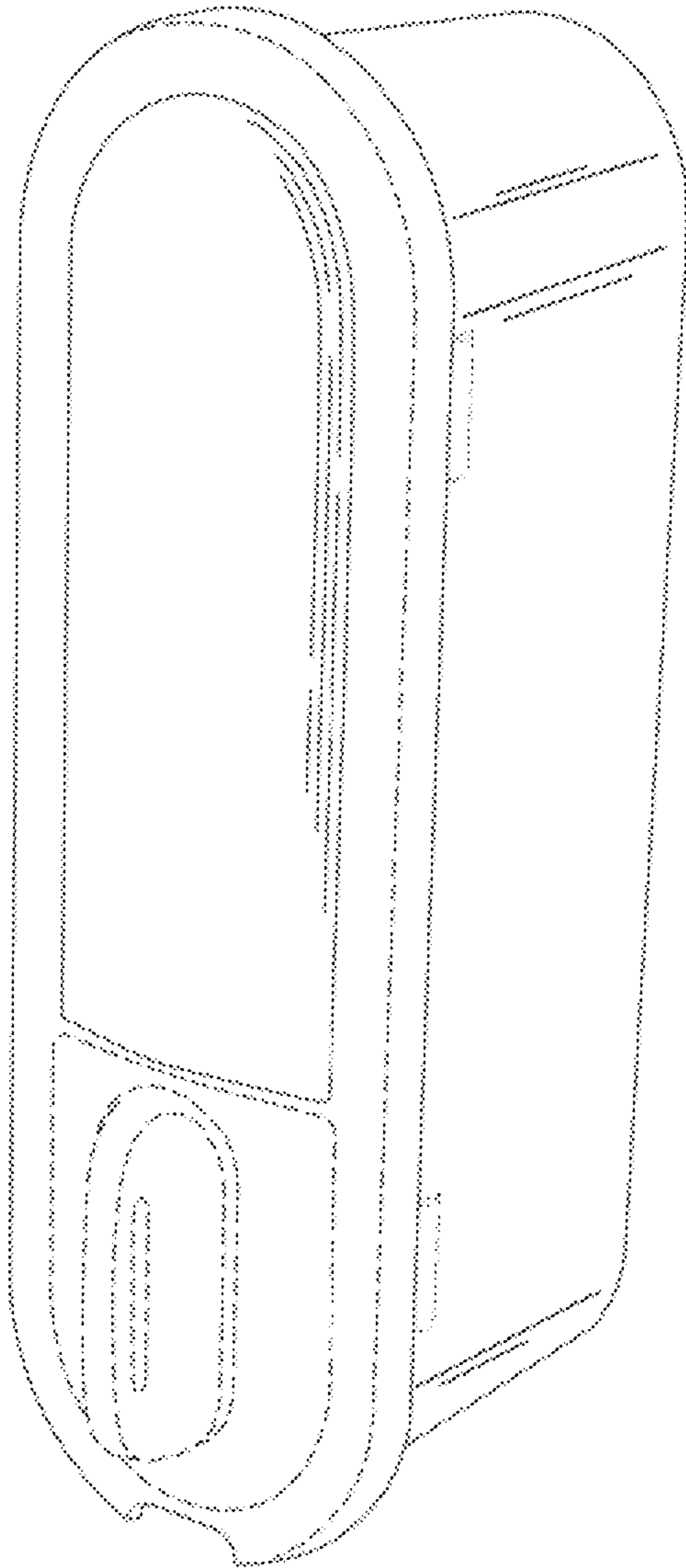

FIG. 1

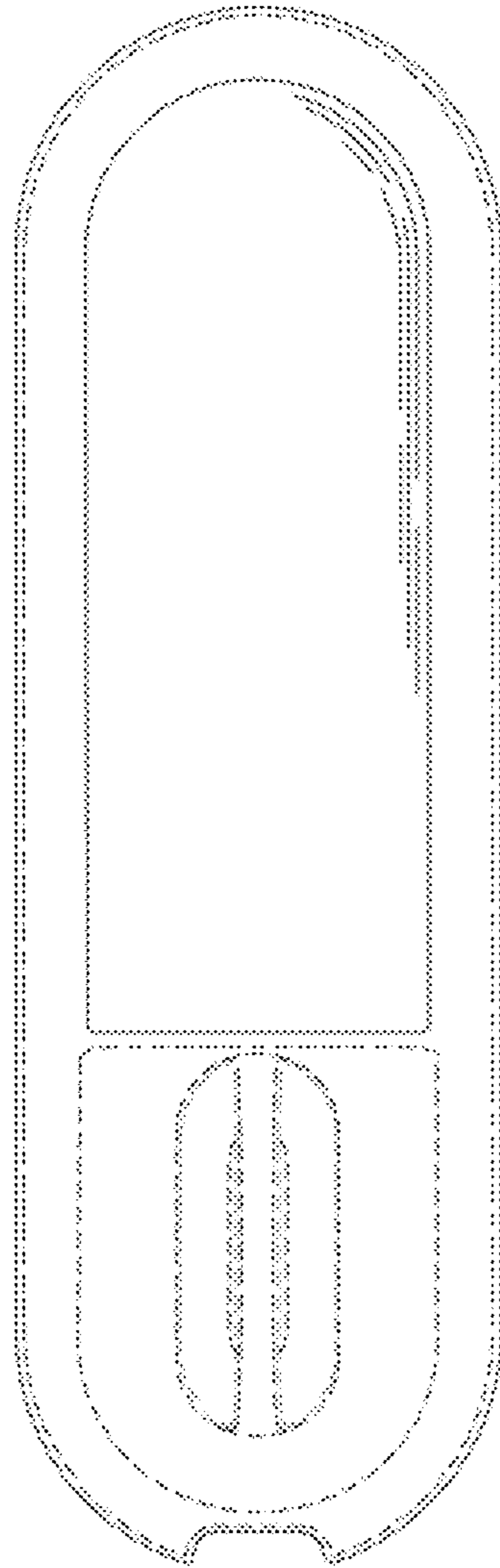

FIG. 2

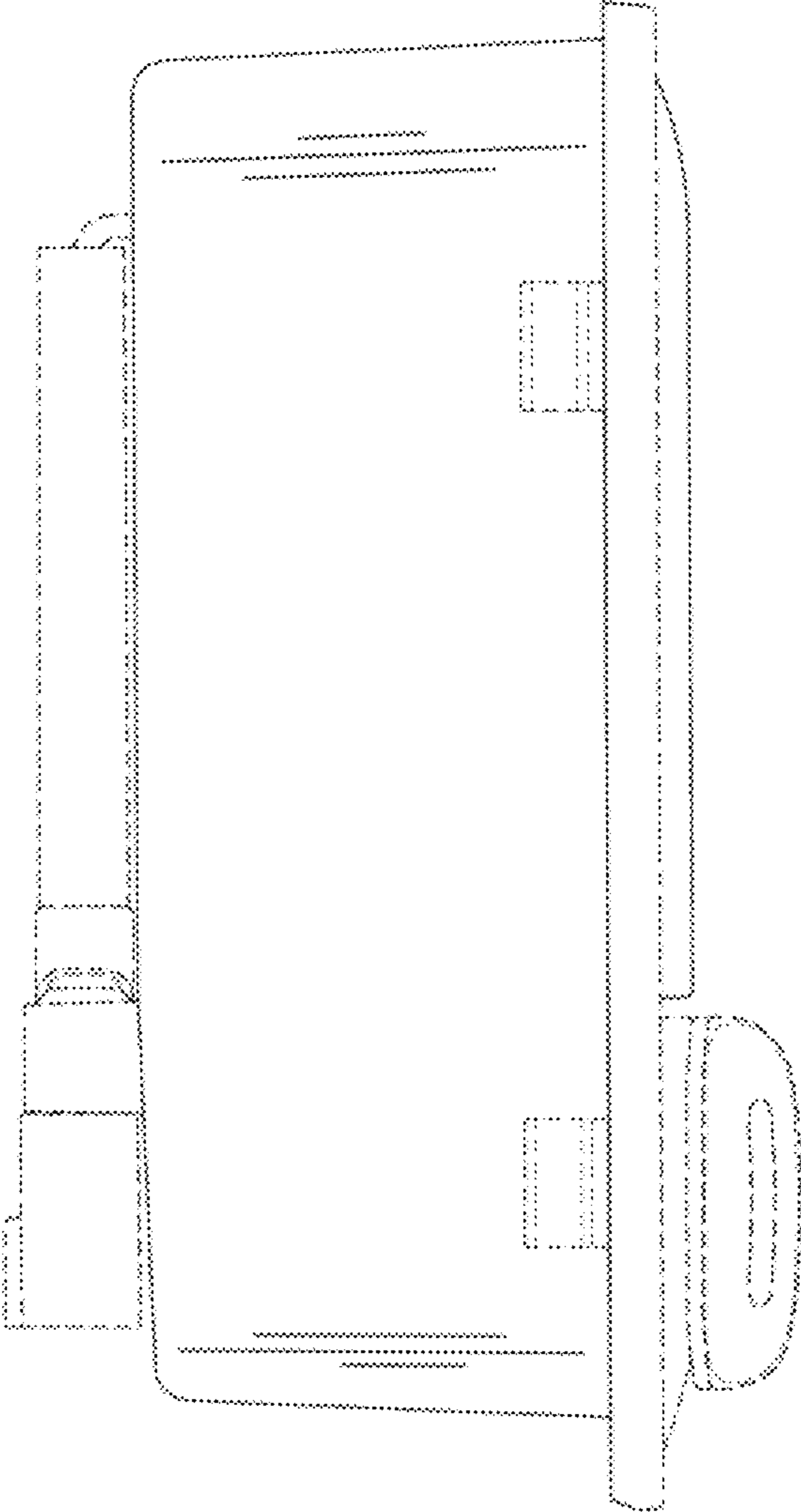

FIG. 3

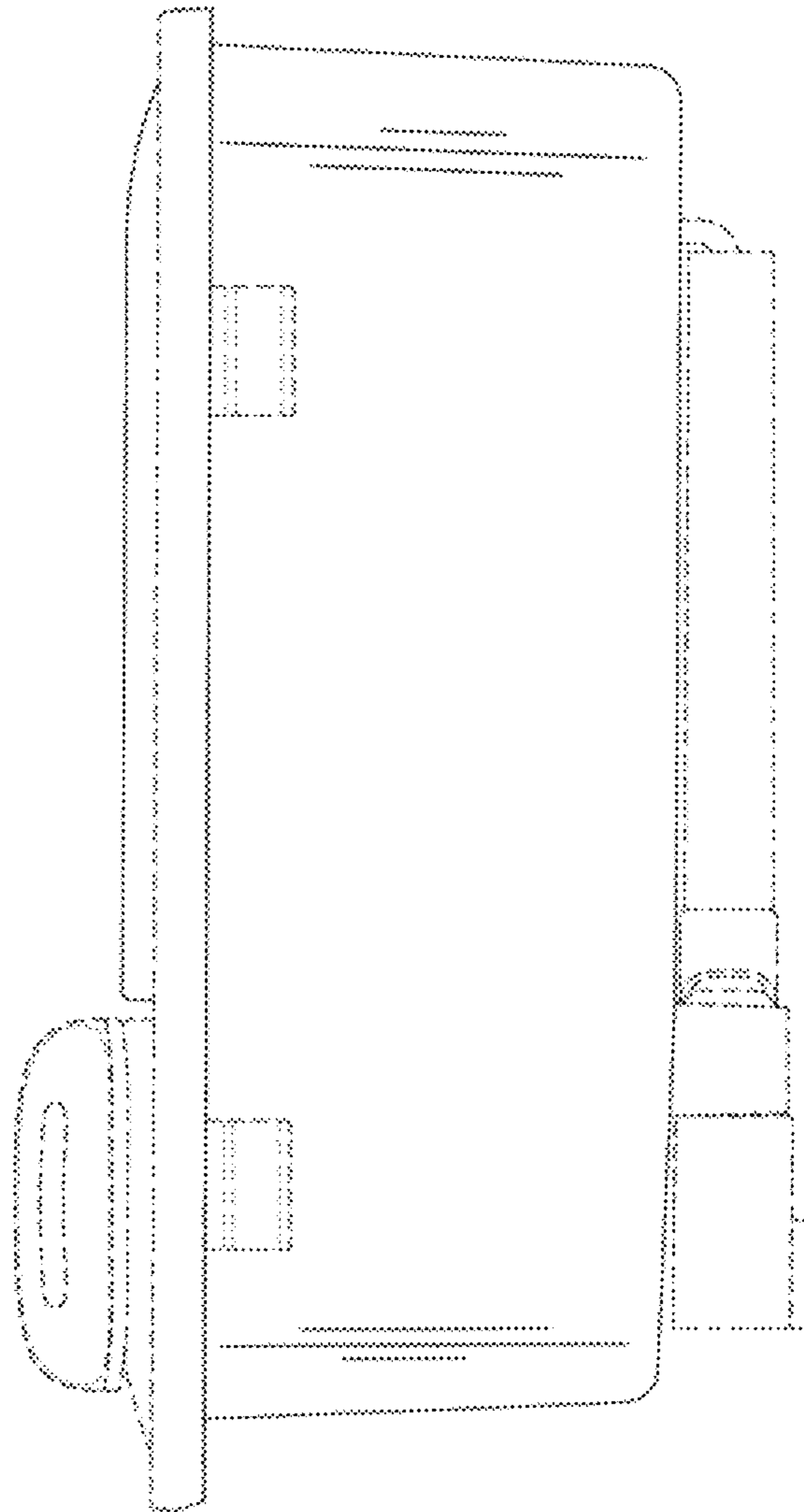

FIG. 4

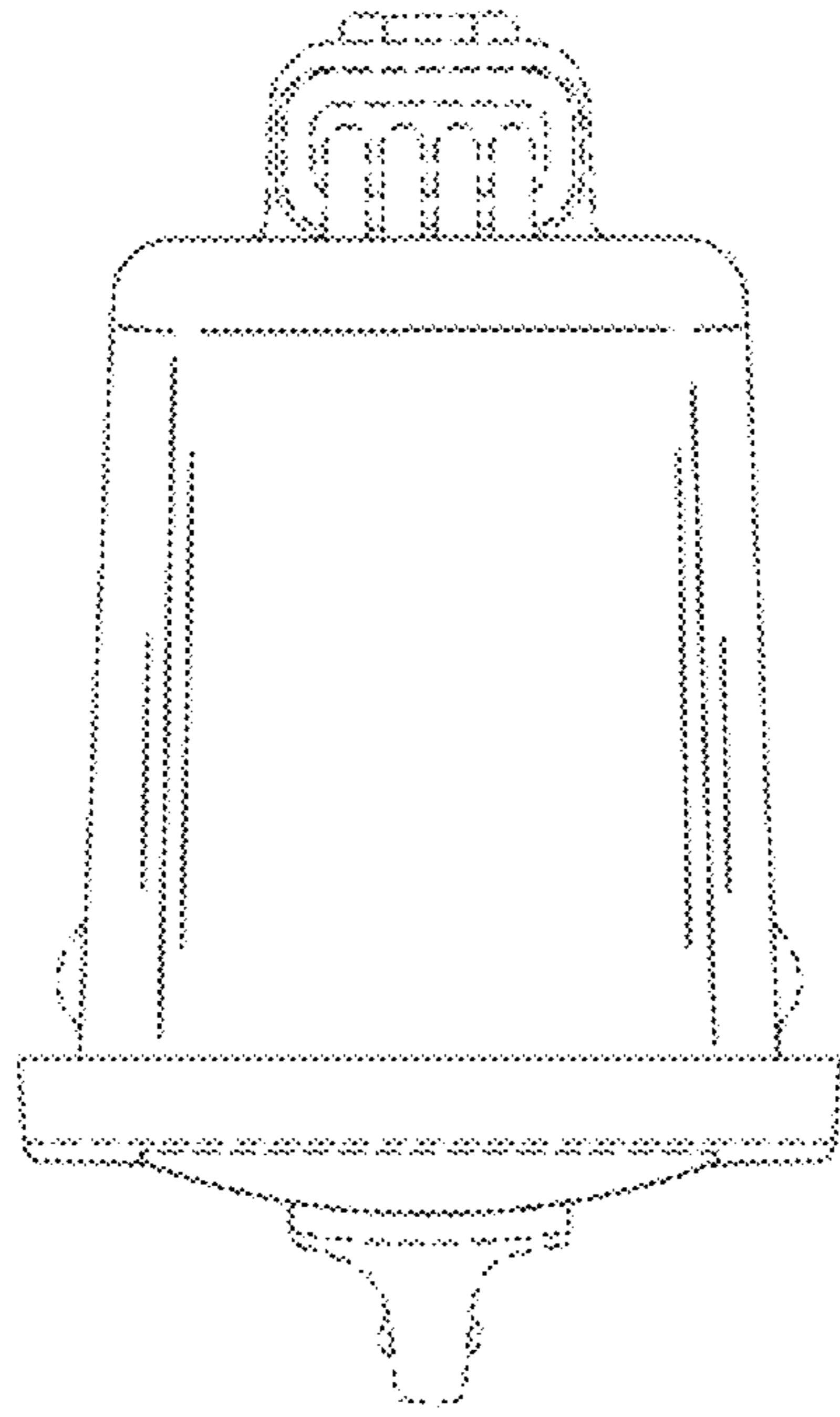

FIG. 5

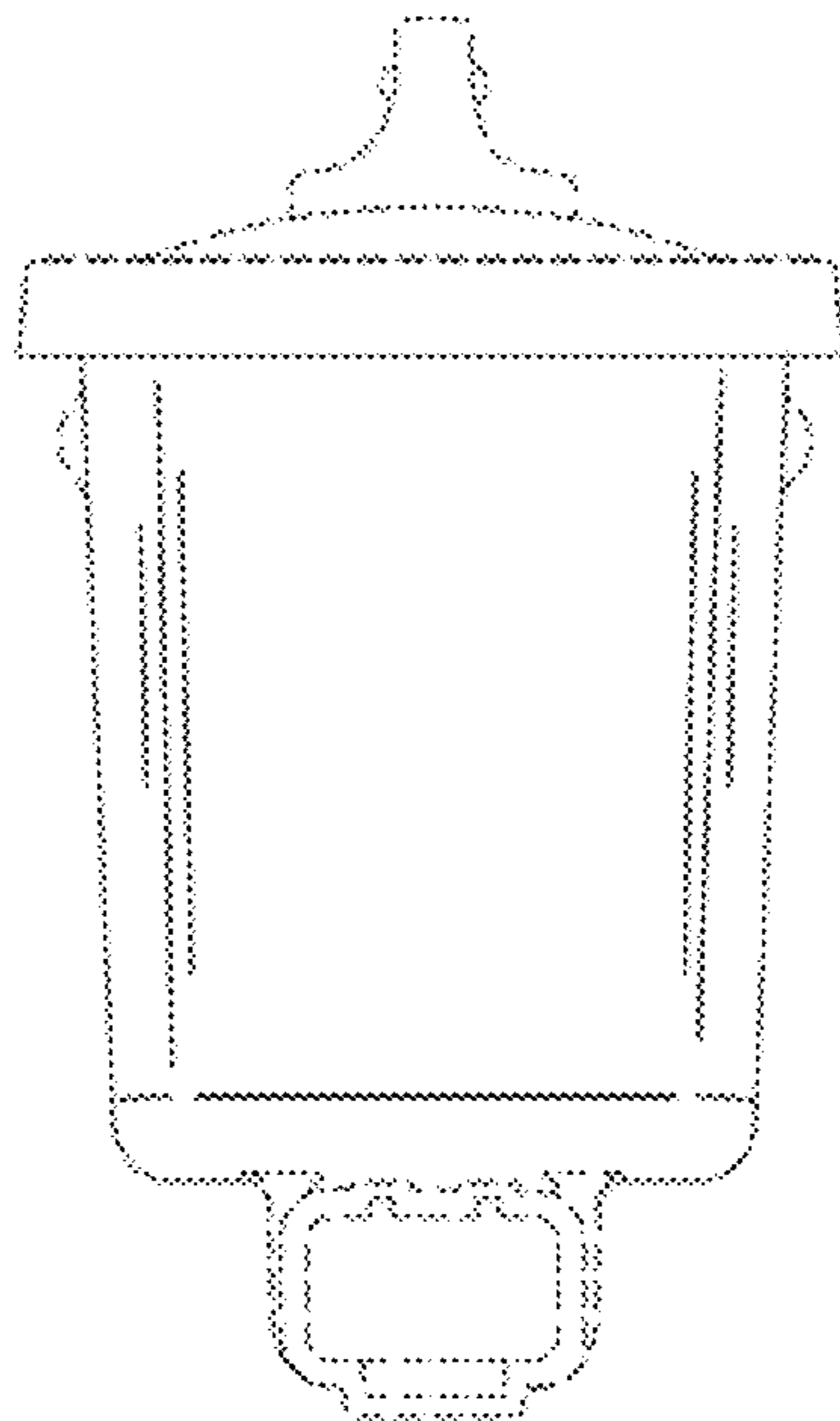

FIG. 6

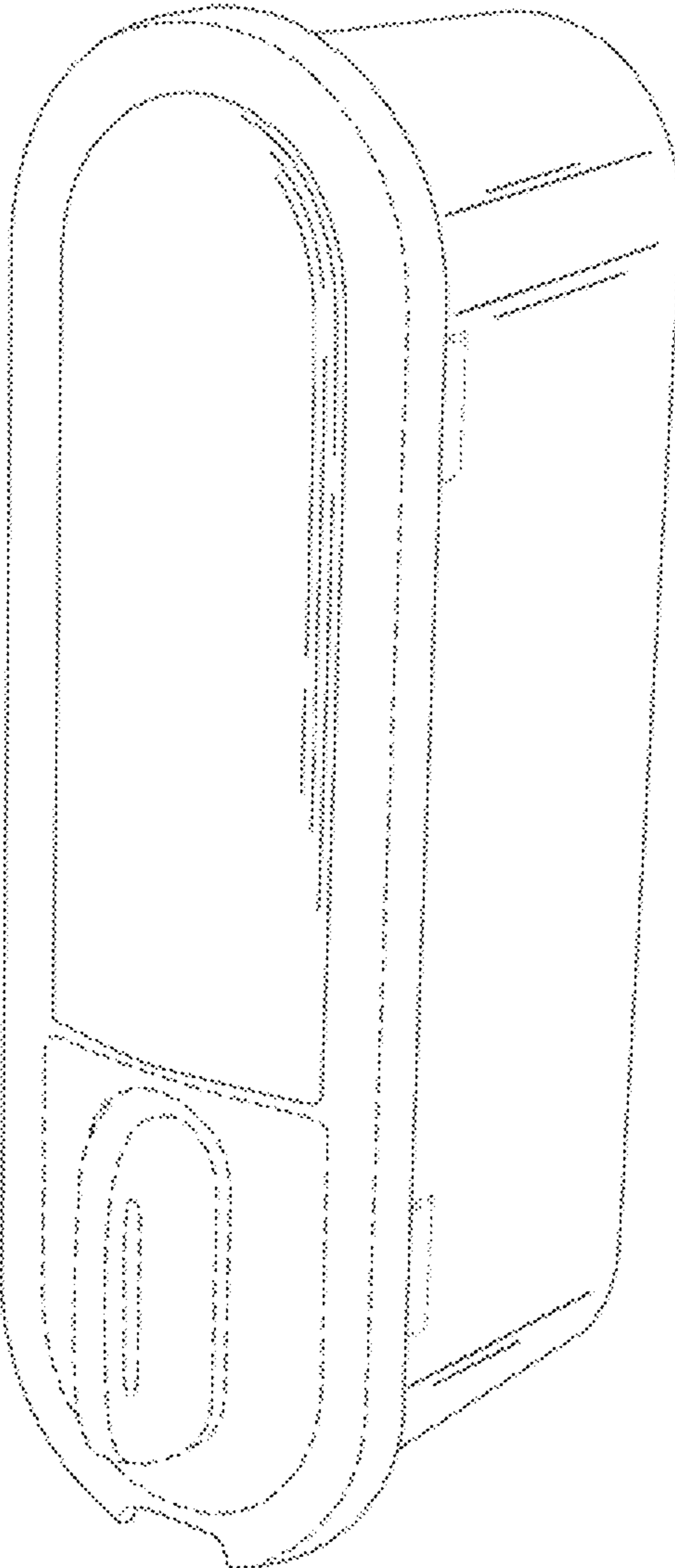

FIG. 7

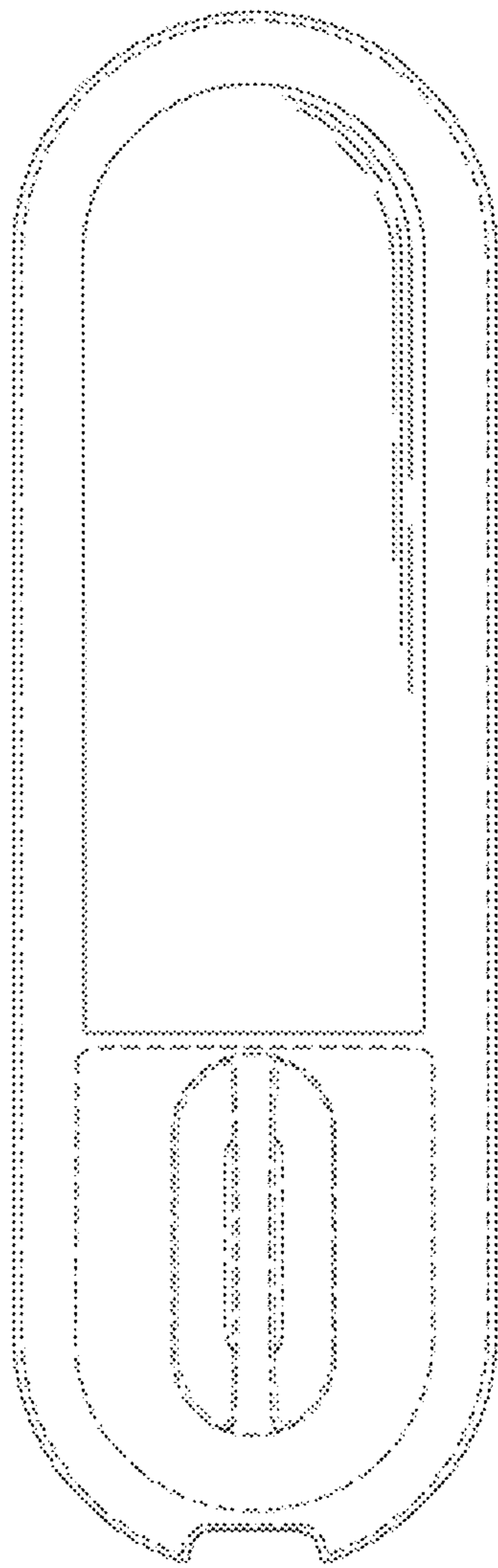

FIG. 8

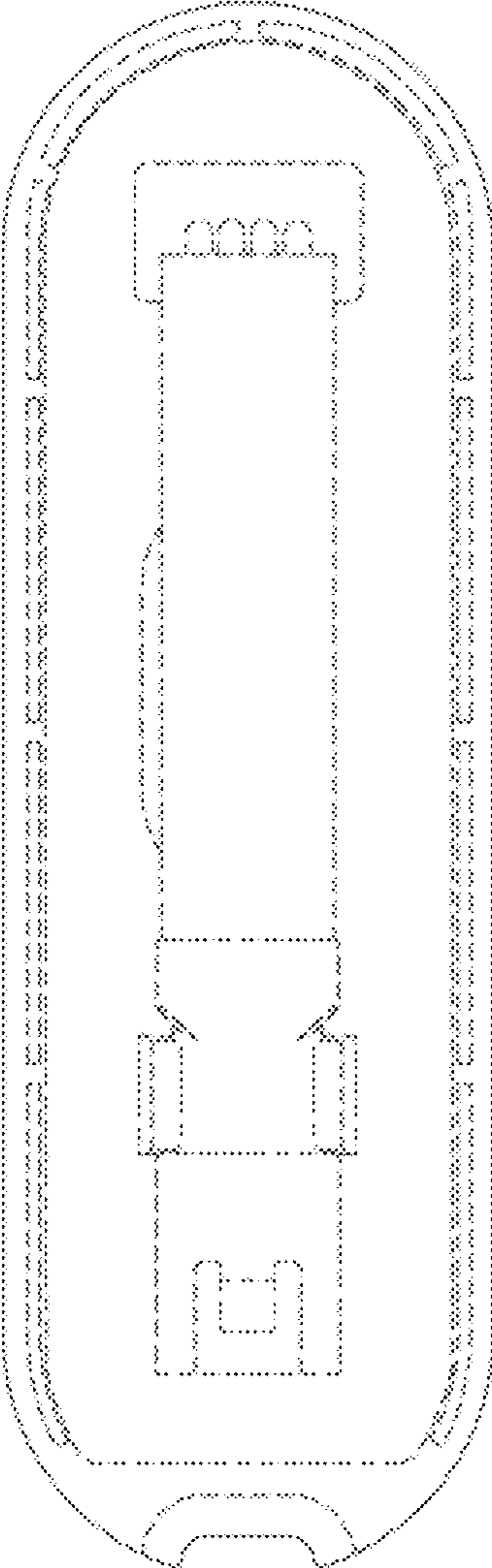

FIG. 9

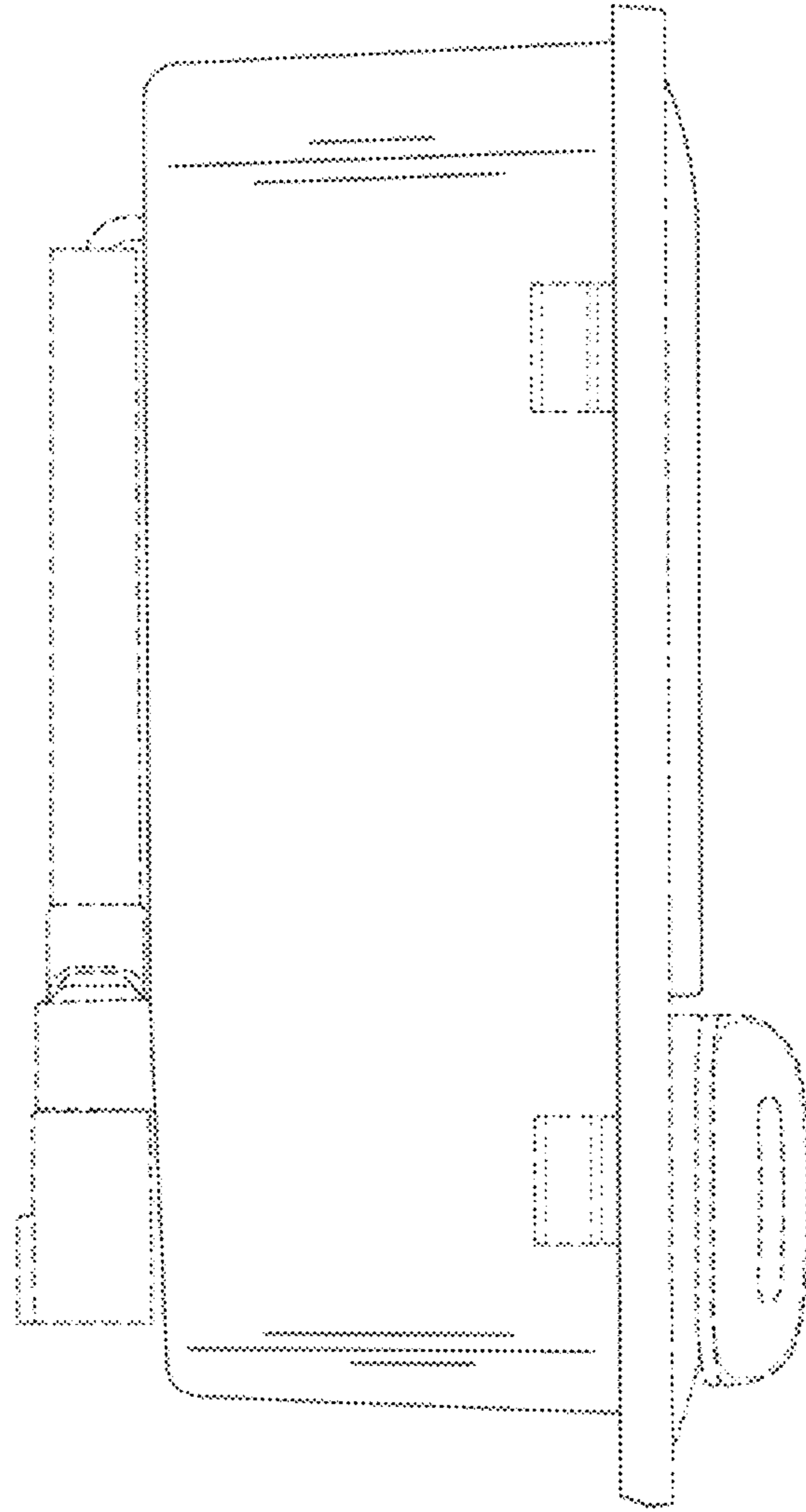

FIG. 10

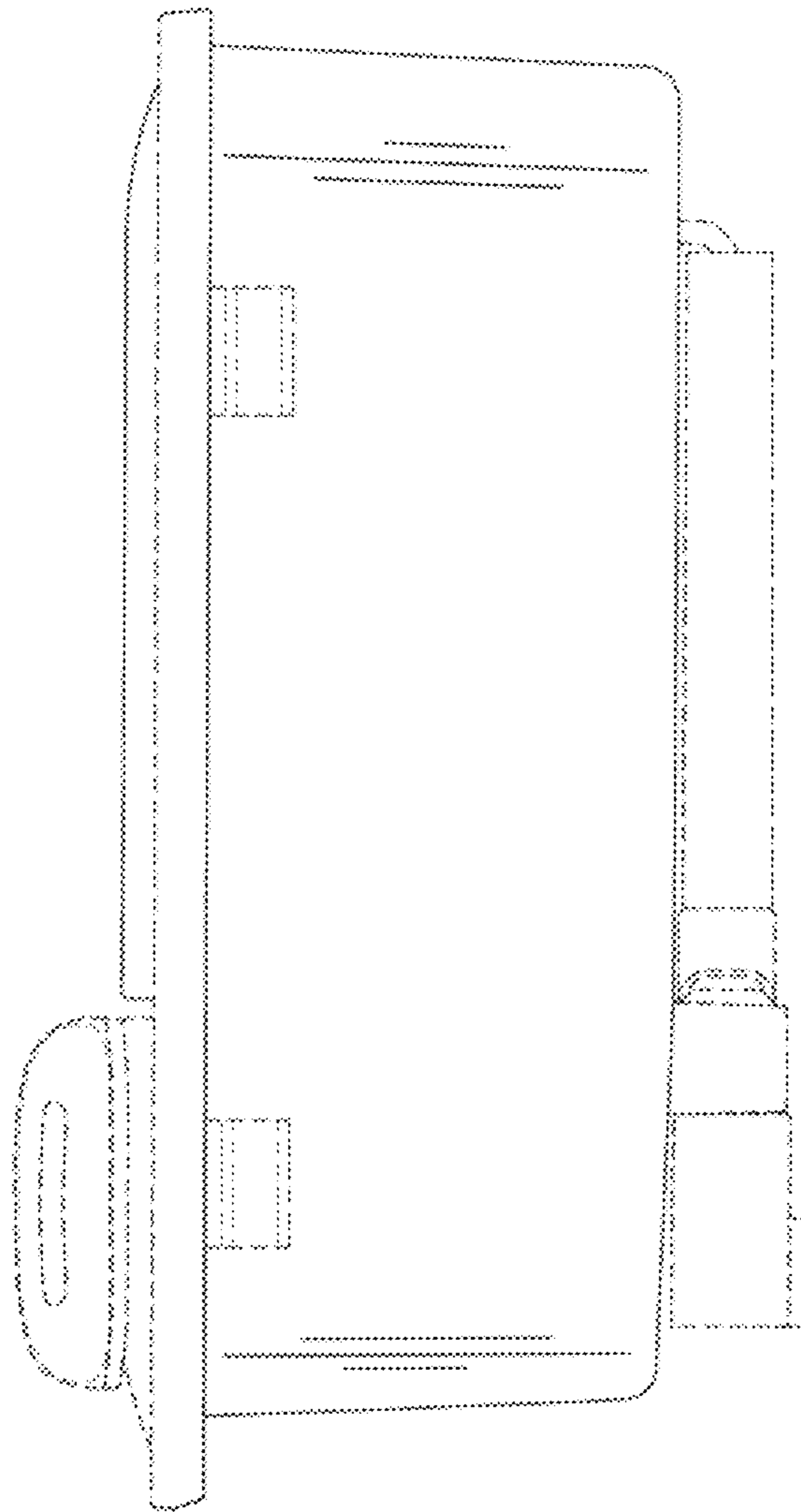

FIG. 11

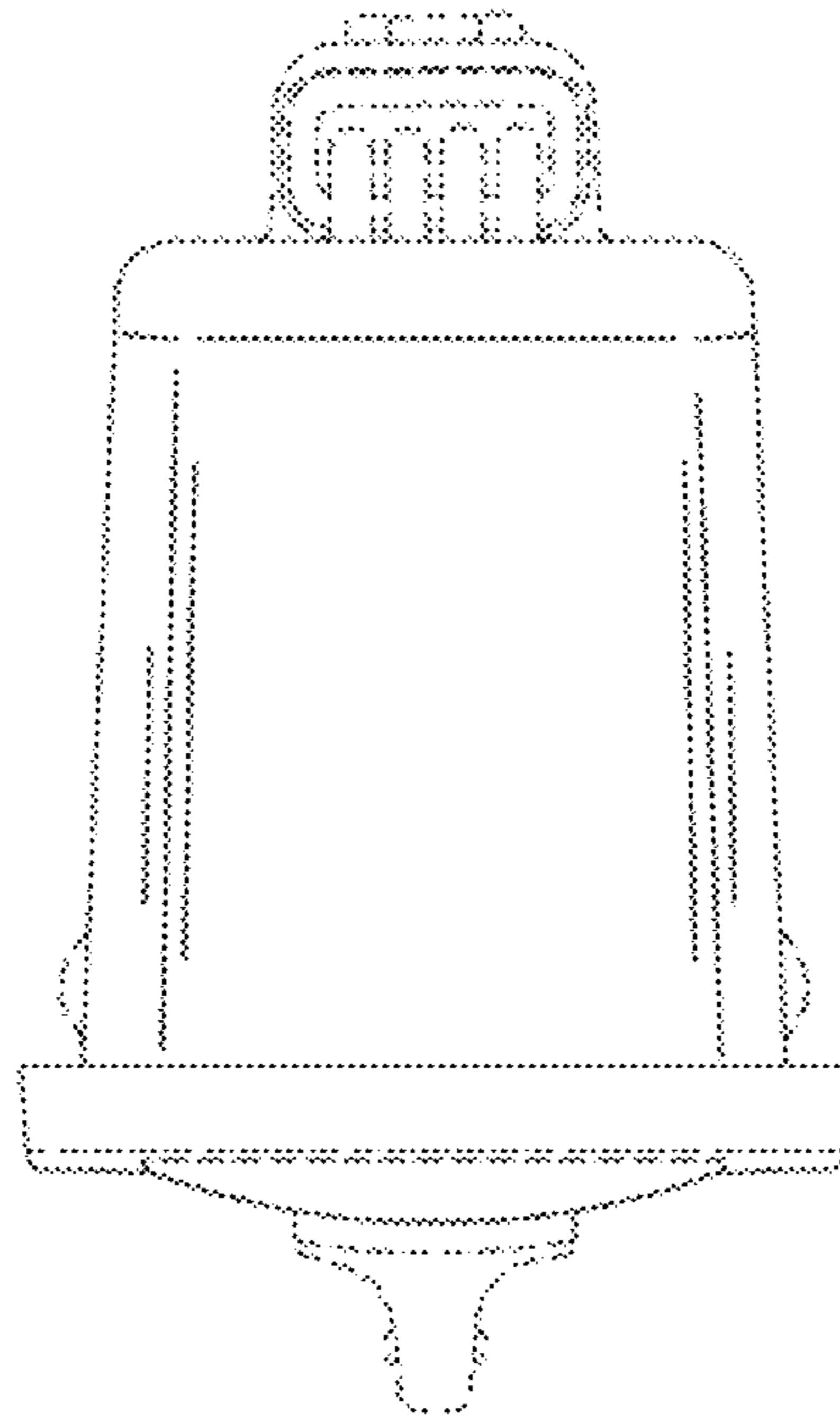

FIG. 12

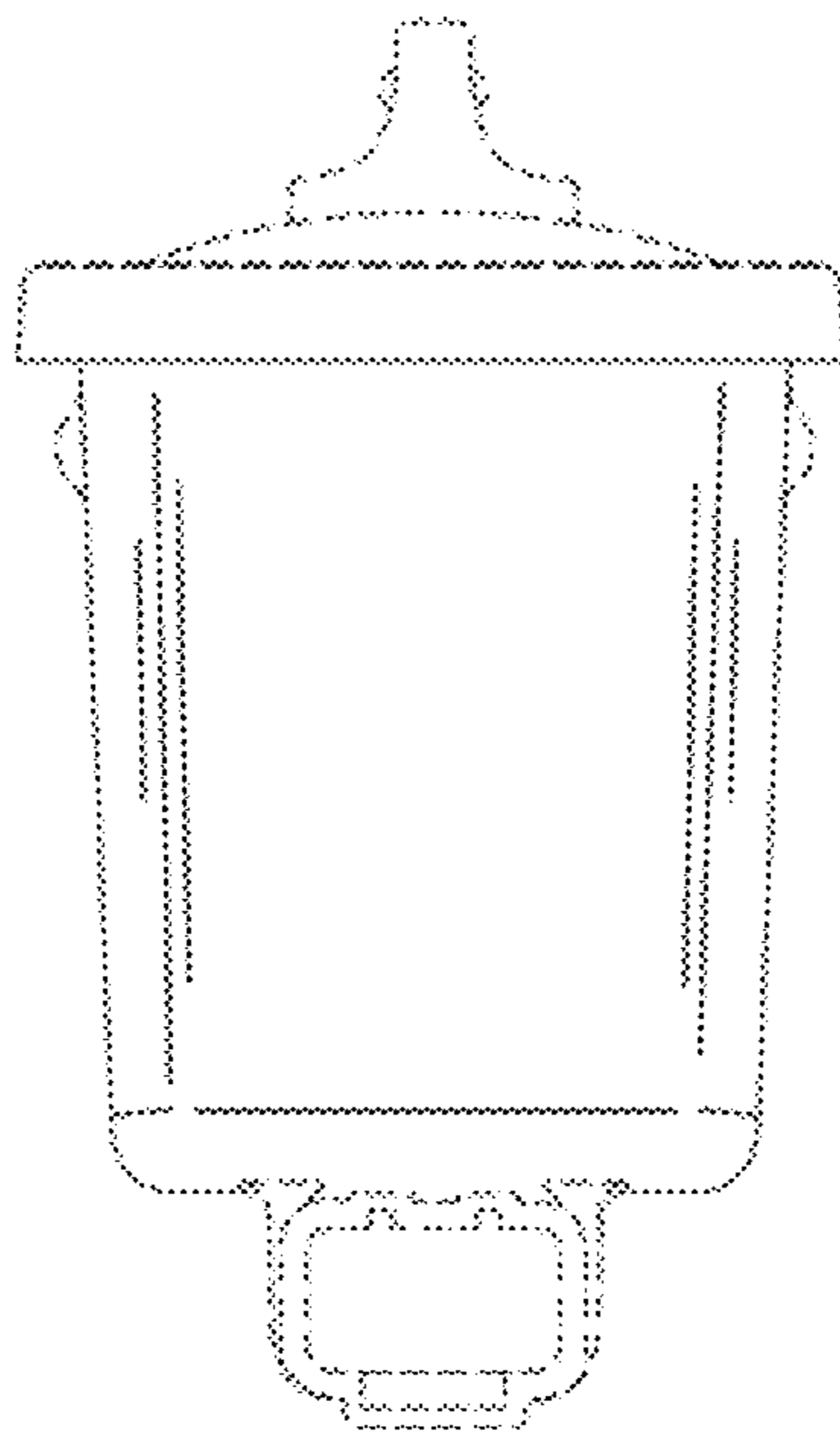

FIG. 13