



US00D776832S

(12) **United States Design Patent** (10) **Patent No.:** **US D776,832 S**
Gibson (45) **Date of Patent:** **** Jan. 17, 2017**

- (54) **CONCRETE BLOCK**
- (71) Applicant: **Stephen M. Gibson**, Hawthorne, FL (US)
- (72) Inventor: **Stephen M. Gibson**, Hawthorne, FL (US)
- (**) Term: **15 Years**
- (21) Appl. No.: **29/530,074**
- (22) Filed: **Jun. 12, 2015**
- (51) **LOC (10) Cl.** **25-01**
- (52) **U.S. Cl.**
USPC **D25/118**
- (58) **Field of Classification Search**
USPC D21/484-491, 499-504; D25/102, 112, D25/113, 114, 115, 118, 138, 152; 52/258, 286, 52/503-505, 574, 575; 404/27-42; 405/16, 405/284, 286
CPC E04B 2/48
See application file for complete search history.

D266,364 S *	9/1982	Coelho dos Santos	D25/114
D340,772 S *	10/1993	Harrison	D25/118
D342,795 S *	12/1993	Harrison	D25/118
D387,879 S *	12/1997	Henry	D25/118
D629,919 S *	12/2010	Meyer	D25/113
D662,612 S *	6/2012	Dyson	D25/113
D687,166 S *	7/2013	Dyson	D25/113
D695,420 S *	12/2013	Hancock	D25/113
2012/0159889 A1 *	6/2012	Dyson	E04B 2/48 52/503

* cited by examiner

Primary Examiner — Susan Bennett Hattan
Assistant Examiner — Leanne Was
(74) *Attorney, Agent, or Firm* — Arthur G. Yeager

(57) **CLAIM**
The ornamental design for a concrete block.

DESCRIPTION

FIG. 1 is a top rear perspective view of a concrete block in accord with my design;
FIG. 2 is a bottom rear perspective view thereof;
FIG. 3 is a side elevational view thereof, the opposite side being the mirror image thereof;
FIG. 4 is a top plan view thereof;
FIG. 5 is a bottom plan view thereof;
FIG. 6 is a rear end elevational view thereof; and,
FIG. 7 is a front end elevational view thereof.

1 Claim, 4 Drawing Sheets

- (56) **References Cited**
U.S. PATENT DOCUMENTS
3,534,518 A * 10/1970 Zagray E04B 2/46
52/258
D266,362 S * 9/1982 Coelho dos Santos D25/114

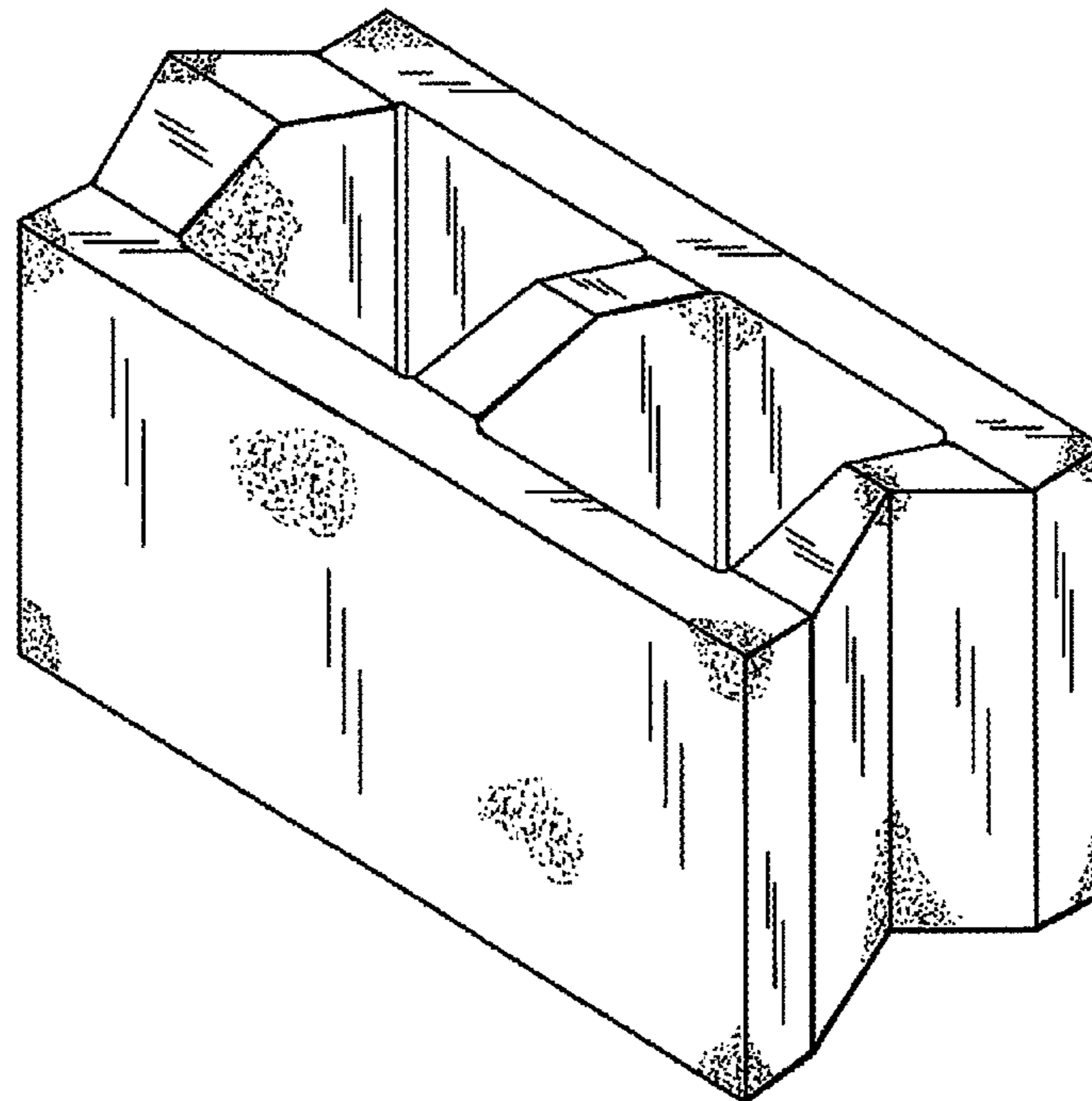

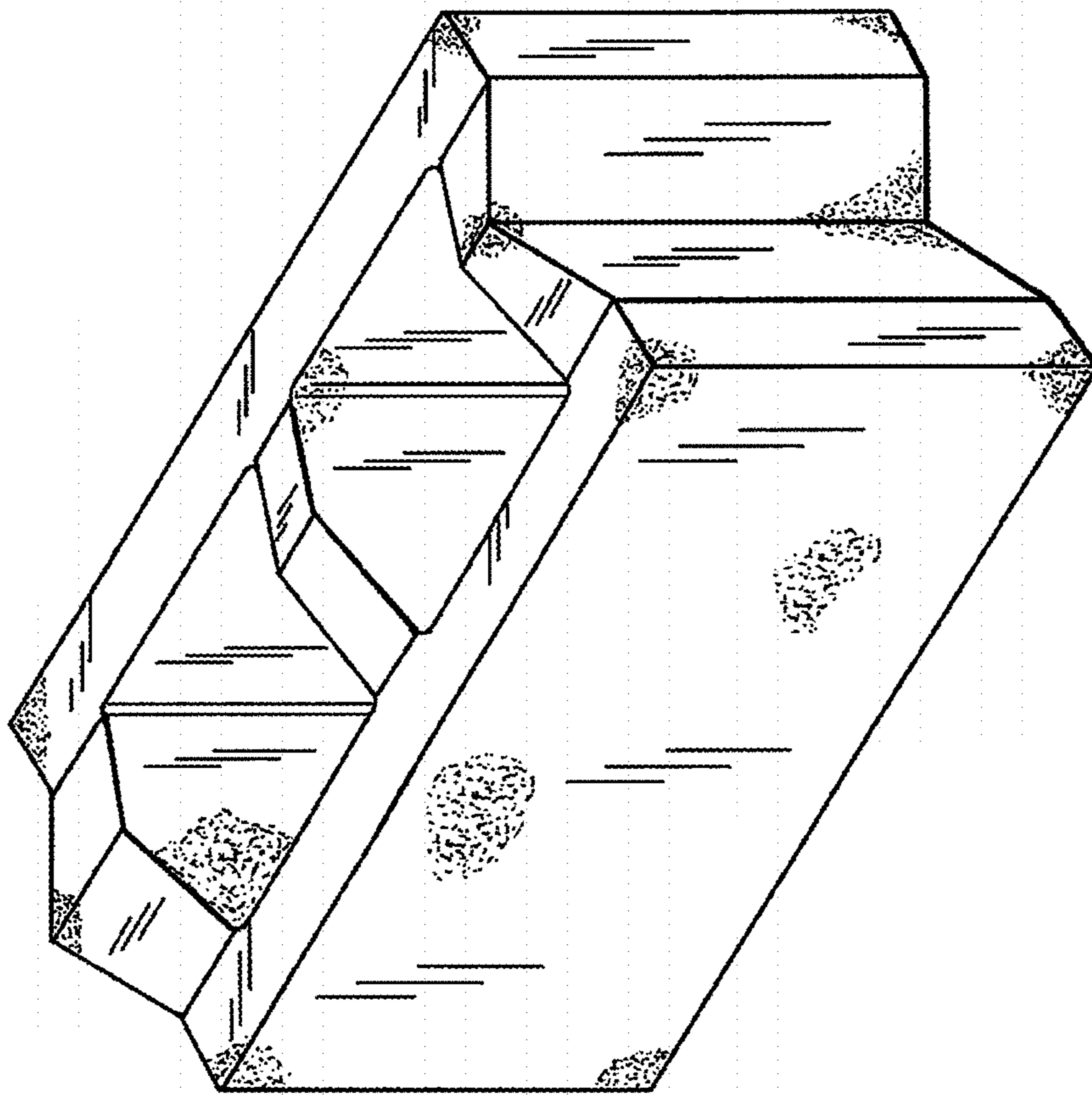

FIG.1

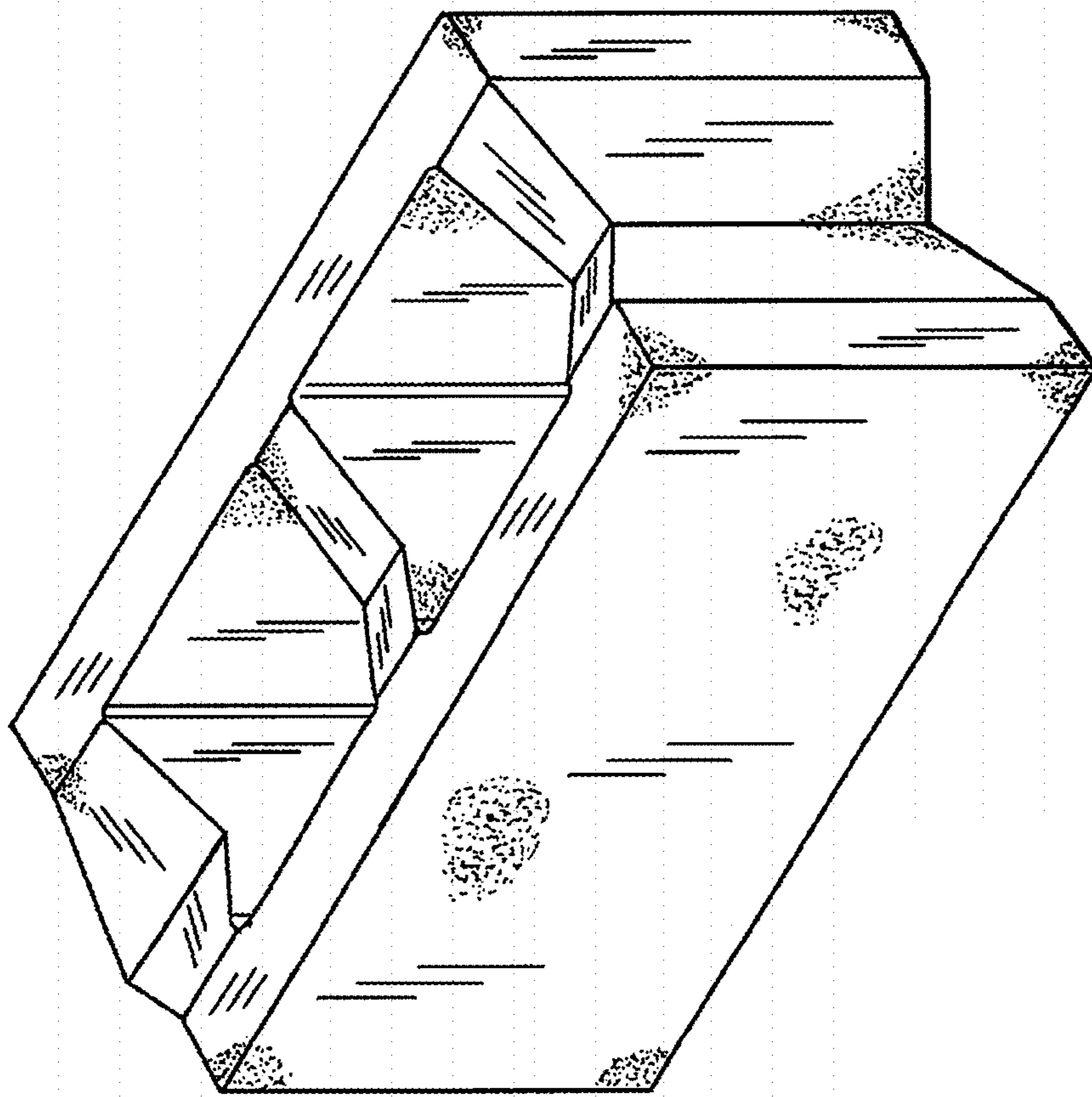

FIG.2

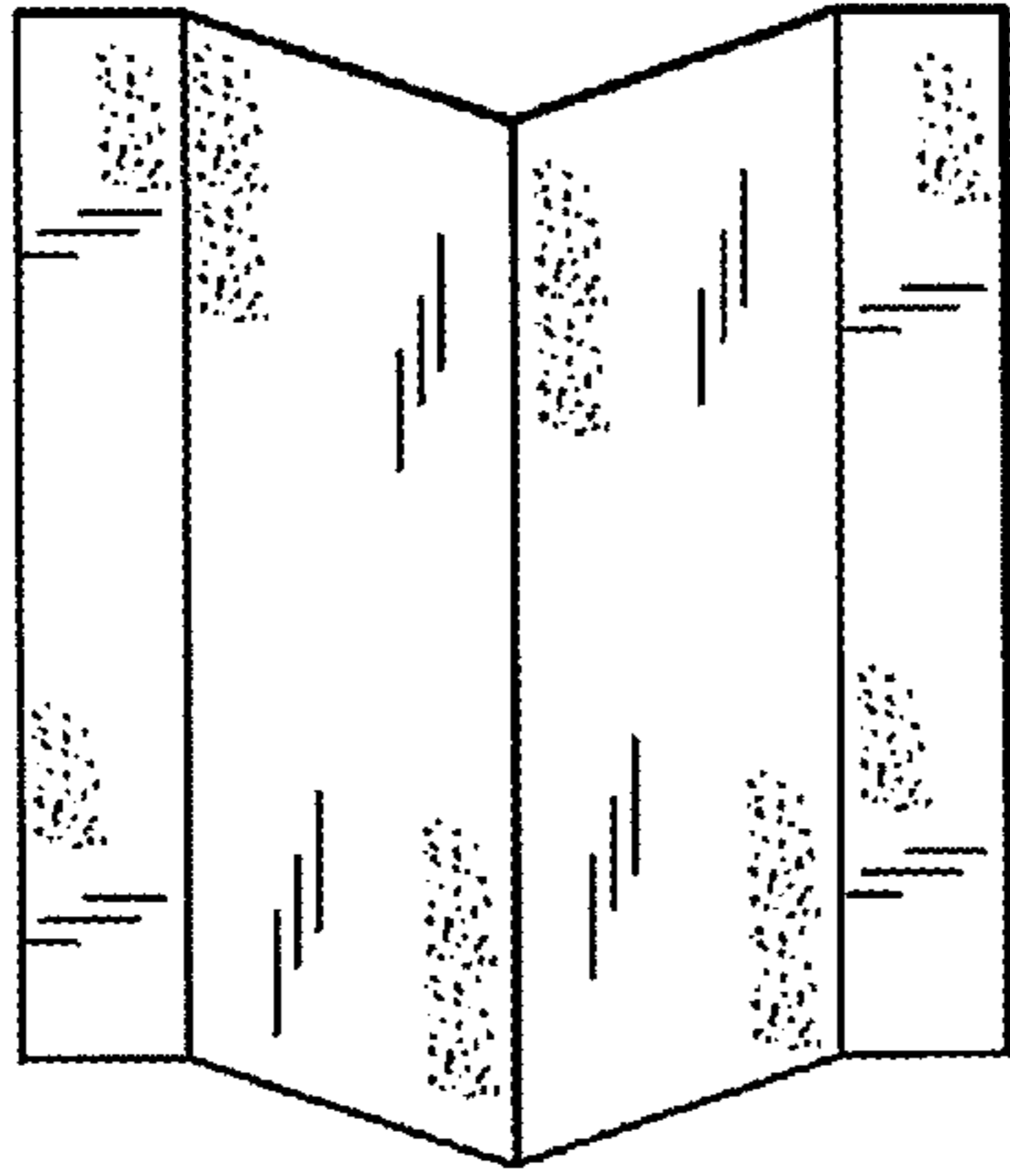

FIG. 6

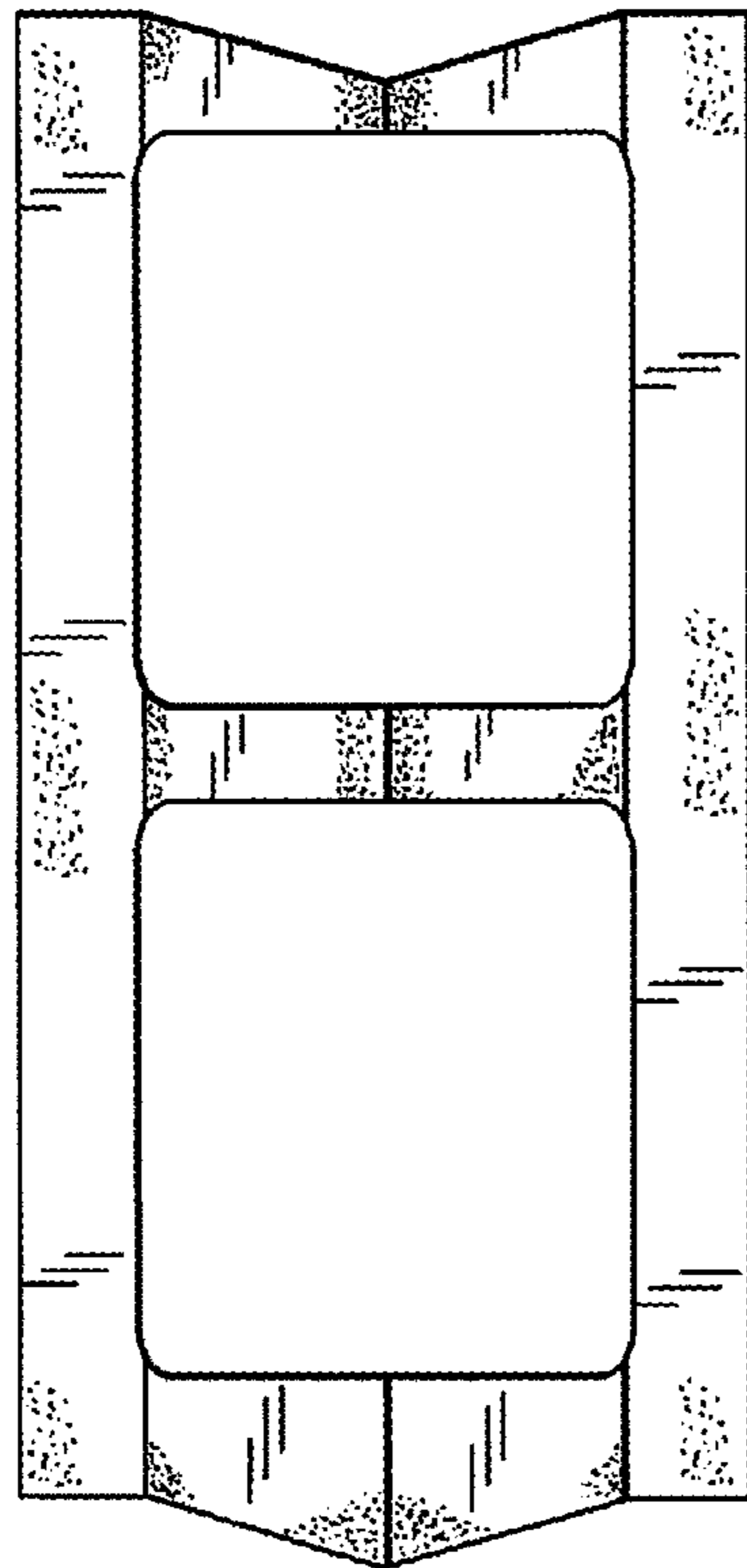

FIG. 4

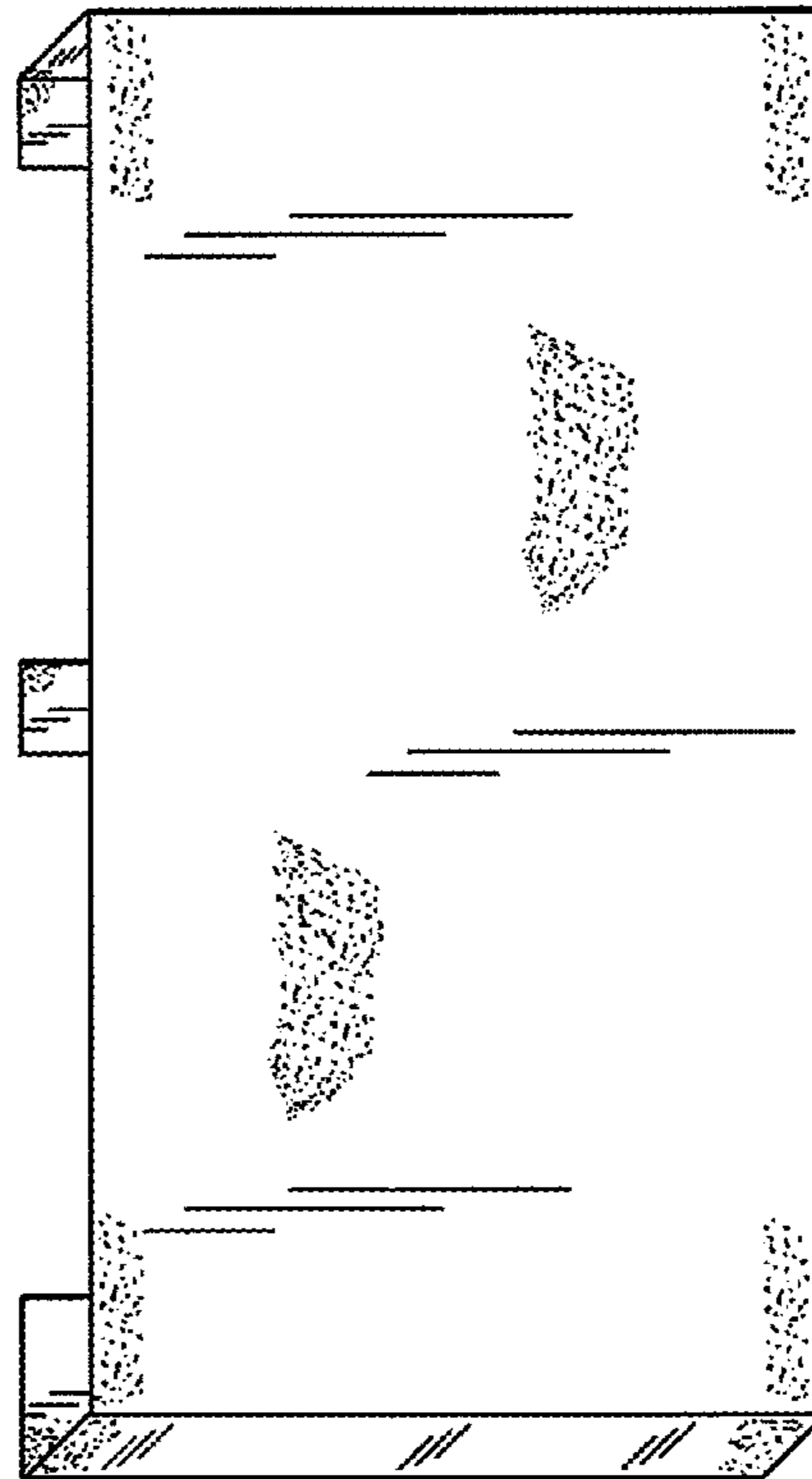

FIG. 3

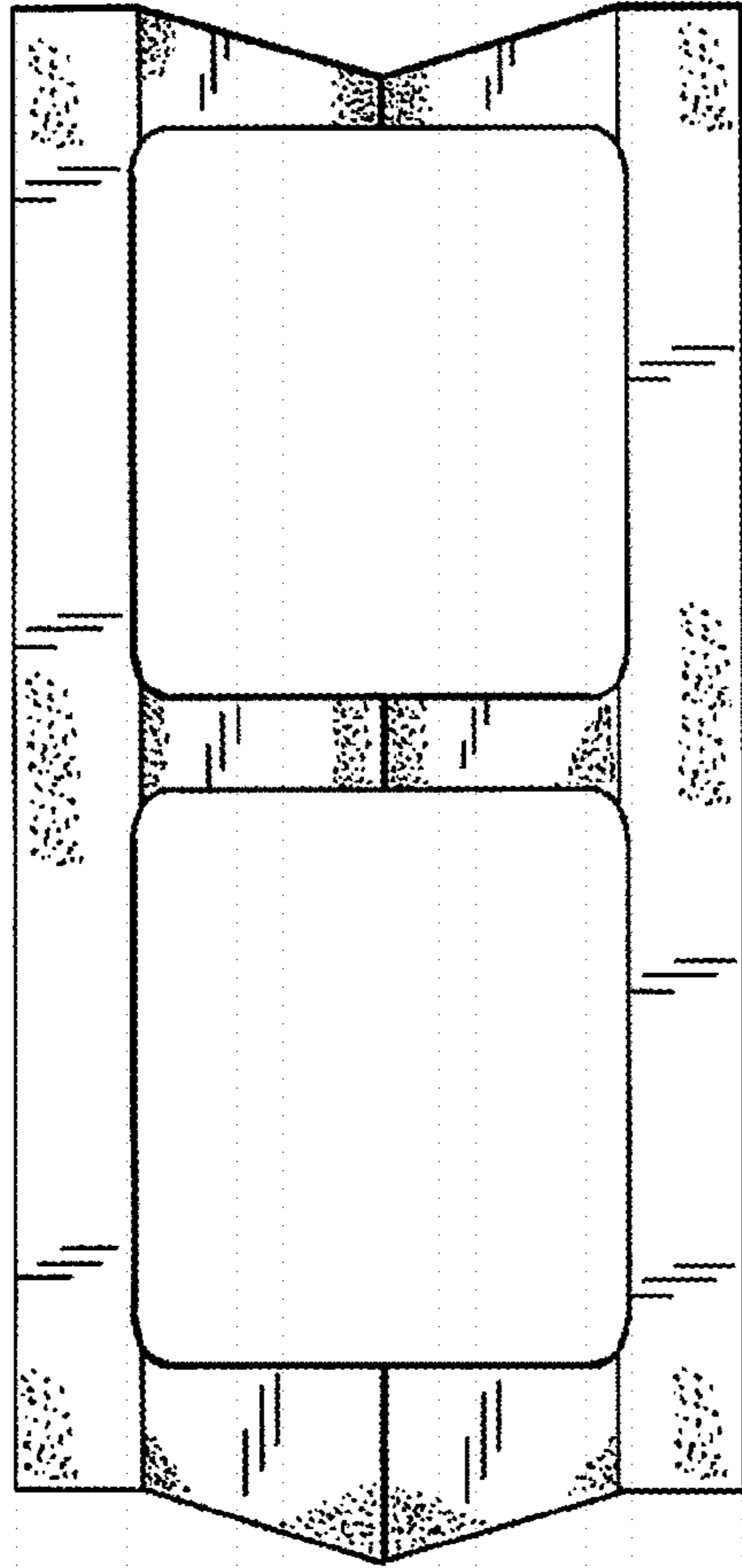

FIG. 5

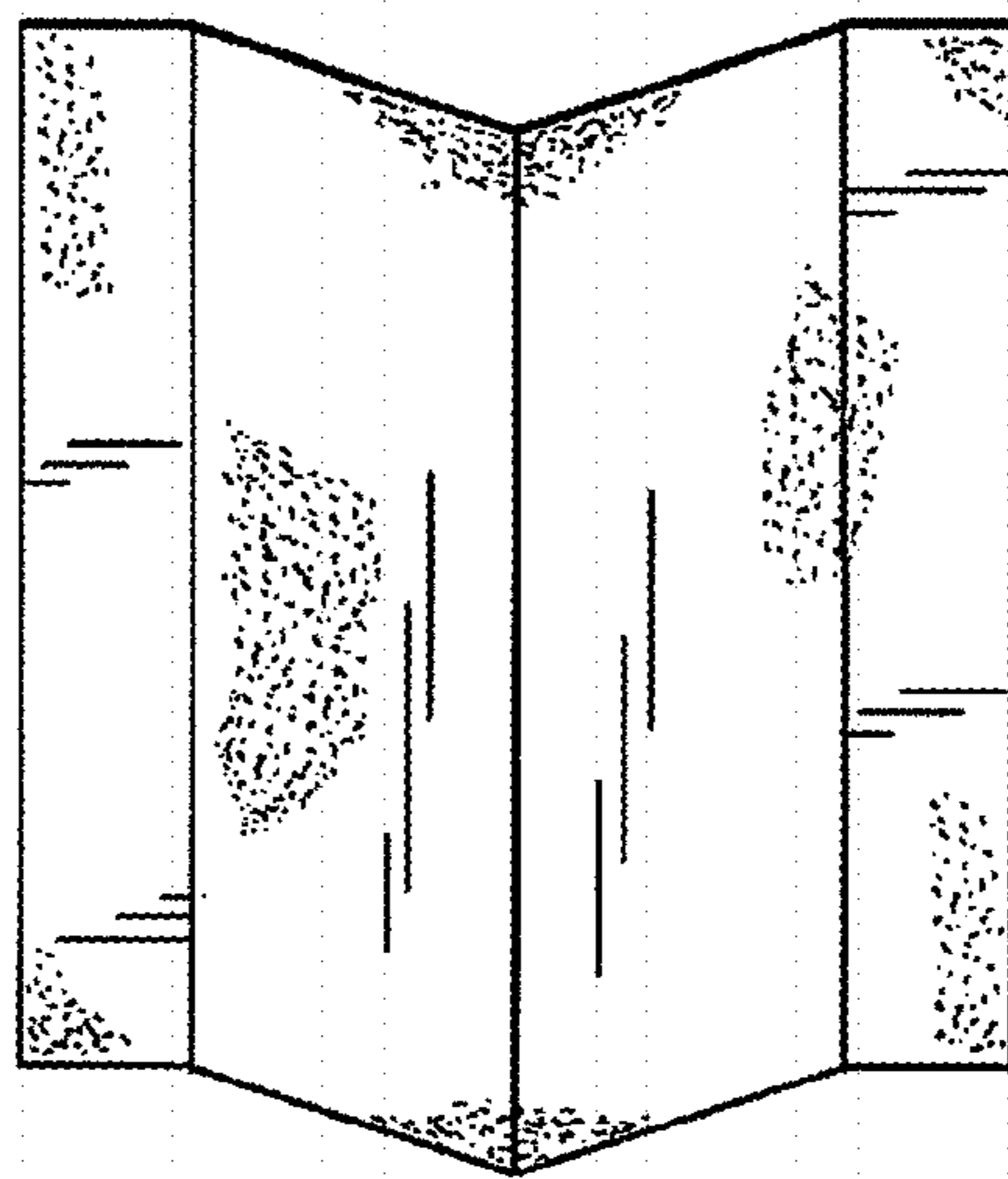

FIG. 7