



US00D776764S

(12) **United States Design Patent** (10) **Patent No.:** **US D776,764 S**
Kuramoto et al. (45) **Date of Patent:** **** Jan. 17, 2017**

(54) **STRAP FOR WATCH-SHAPED TOY**
(71) Applicant: **BANDAI CO., LTD.**, Tokyo (JP)
(72) Inventors: **Yukiko Kuramoto**, Tokyo (JP);
Nakayuki Sato, Tokyo (JP)
(73) Assignee: **BANDAI CO., LTD.**, Tokyo (JP)
(**) Term: **15 Years**

D432,025 S * 10/2000 McLinden D10/30
D476,905 S * 7/2003 El Kadiri D10/30
D482,340 S * 11/2003 Cianfanelli D10/31
D565,426 S * 4/2008 Rabassa D10/30
D709,967 S * 7/2014 Takahashi D21/579
D721,405 S * 1/2015 Nishizawa D21/398
D722,653 S * 2/2015 Nishizawa D21/398

(Continued)

FOREIGN PATENT DOCUMENTS

CN 302612931 * 10/2013
JP D1124998 * 10/2001

(21) Appl. No.: **29/541,379**
(22) Filed: **Oct. 2, 2015**

OTHER PUBLICATIONS

Yokai watch review, video date Dec. 18, 2015, <https://www.youtube.com/watch?v=KCFYKBNpK5I>, site visited Aug. 9, 2016.*

(Continued)

(30) **Foreign Application Priority Data**
Apr. 3, 2015 (JP) 2015-007585
(51) **LOC (10) Cl.** **21-01**
(52) **U.S. Cl.**
USPC **D21/531**; D10/32
(58) **Field of Classification Search**
USPC D21/398, 531, 372, 347, 385;
D10/30-32, 38-39; D9/420
CPC A63H 13/00; A63H 33/30; A44C 5/22;
G04B 19/23; G04B 37/14
See application file for complete search history.

Primary Examiner — Eric Goodman
Assistant Examiner — John R Yeh
(74) *Attorney, Agent, or Firm* — Rabin & Berdo, P.C.

(57) **CLAIM**

The ornamental design for a strap for watch-shaped toy, as shown and described.

DESCRIPTION

FIG. 1 is a perspective view of a strap for watch-shaped toy; FIG. 2 is another perspective view thereof; FIG. 3 is a top view thereof; FIG. 4 is a bottom view thereof; FIG. 5 is a left side view thereof; FIG. 6 is a right side view thereof; FIG. 7 is a front view thereof; and, FIG. 8 is a rear view thereof. The broken lines shown in the drawings form no part of the claimed design.

(56) **References Cited**
U.S. PATENT DOCUMENTS
D238,660 S * 2/1976 Ruefli D10/30
D239,324 S * 3/1976 Vong D10/32
D241,630 S * 9/1976 Burke et al. D10/32
D247,133 S * 1/1978 Tjep D10/38
4,149,662 A * 4/1979 Ramaciere A44C 5/14
224/164
D279,276 S * 6/1985 Matsuo D11/4
4,571,199 A * 2/1986 Murakami G04B 37/0008
446/135
D284,357 S * 6/1986 Nakane D10/32
D288,343 S * 2/1987 Ogawa D21/531

1 Claim, 6 Drawing Sheets

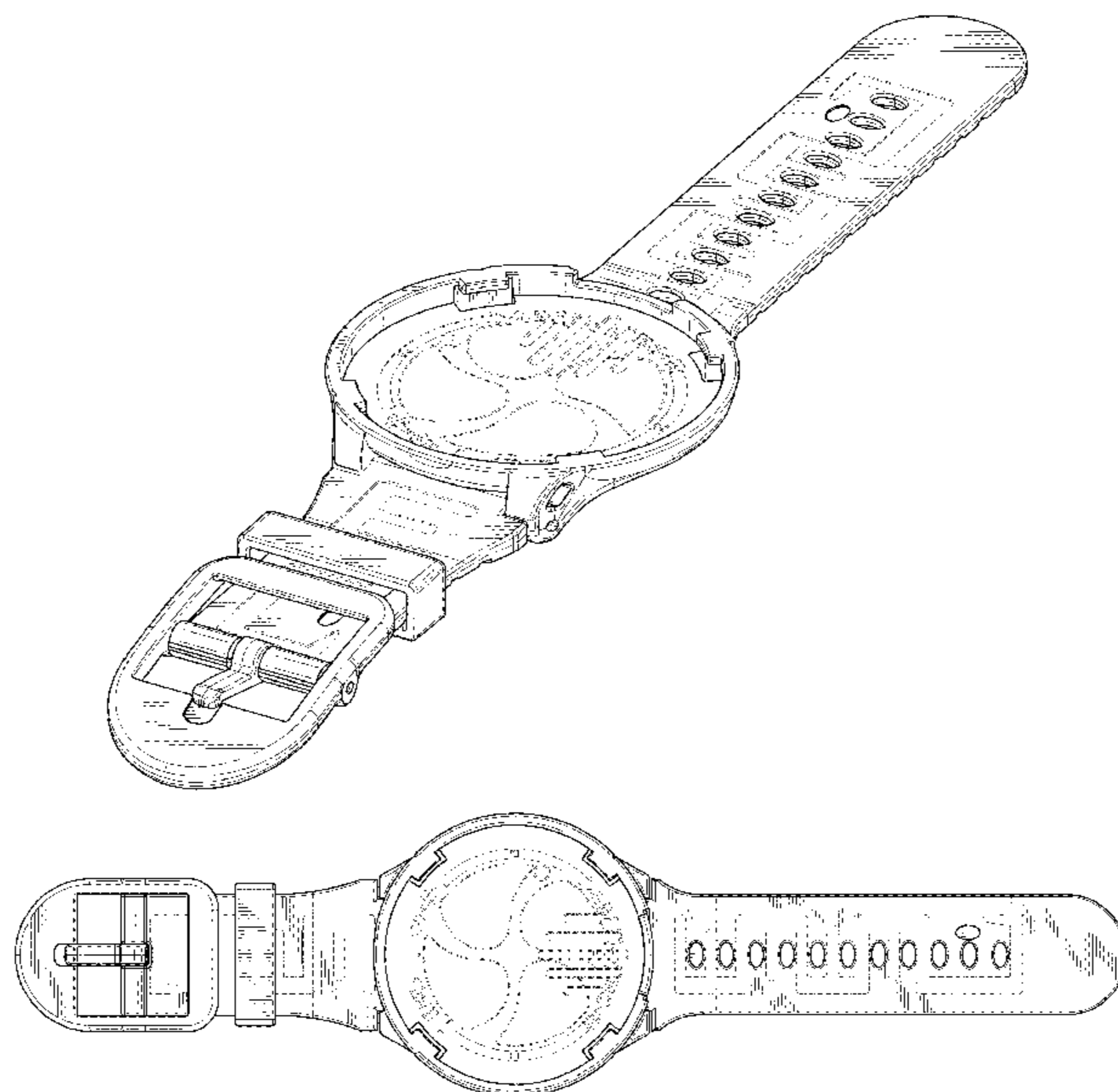

(56)

References Cited

U.S. PATENT DOCUMENTS

D758,504 S * 6/2016 Shimoda D21/531
2008/0049560 A1 * 2/2008 Clarkson G04B 37/1486
368/281
2011/0309116 A1 * 12/2011 Shindo A44B 11/006
224/164

OTHER PUBLICATIONS

YoKai Watch Toy Review, video date Jan. 24, 2015, <https://www.youtube.com/watch?v=8i4B6NhKI-M>, site visited Aug. 9, 2016.*
DX Youkai Watch by Bandai | HobbyLink Japan, circa Jan. 2014, <https://hlj.com/product/BAN983724>, [site visited Aug. 9, 2016 10:59:14 PM].*
Amazon.com: Yo-kai Watch Season 1 Watch, review date Dec. 25, 2015, https://www.amazon.com/Yo-kai-Watch-Season-1/dp/B015KNDYKE/ref=cm_cr_arp_d_product_top?ie=UTF8#customerReviews, [site visited Aug. 9, 2016 9:42:32 PM].*

* cited by examiner

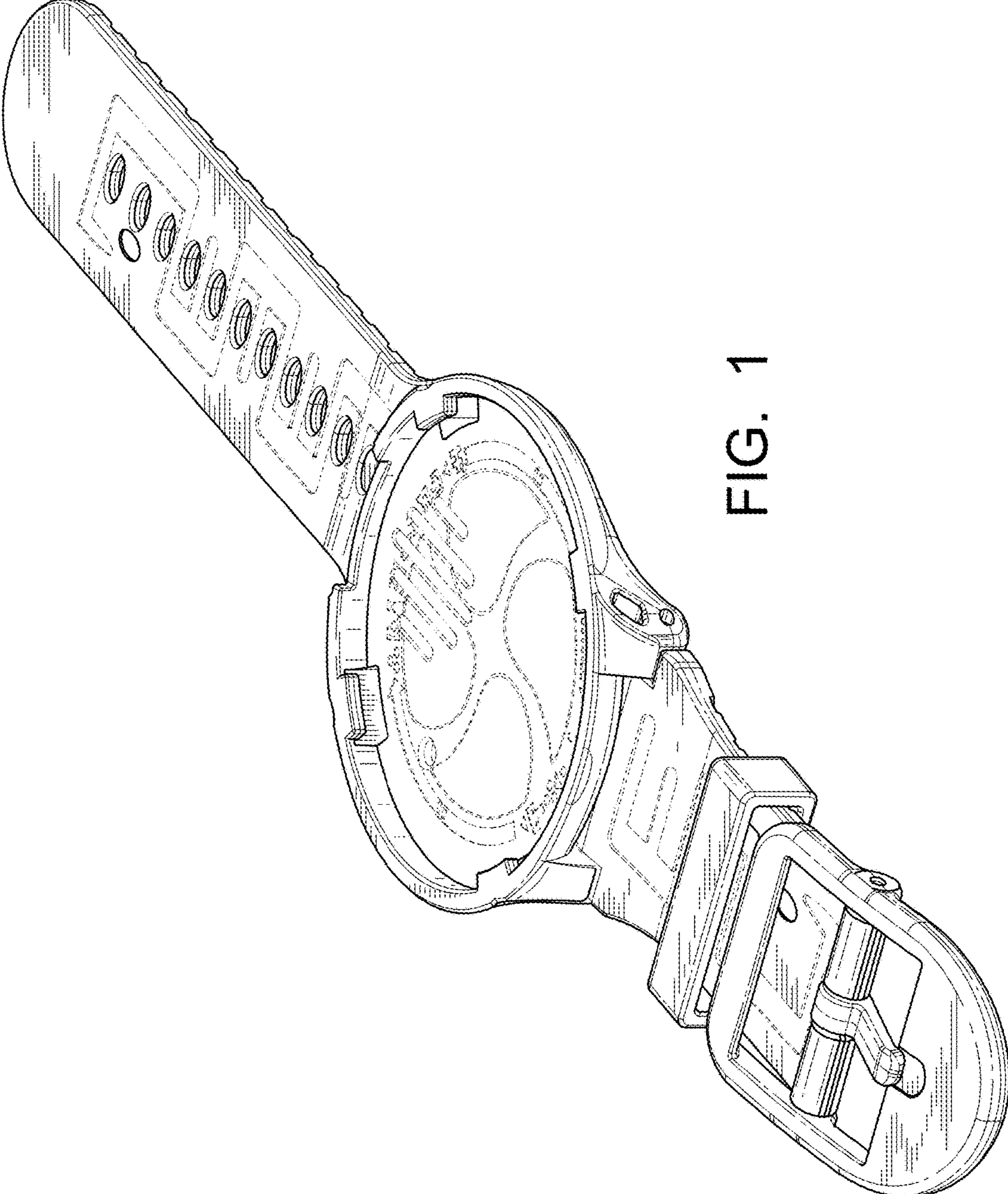

FIG. 1

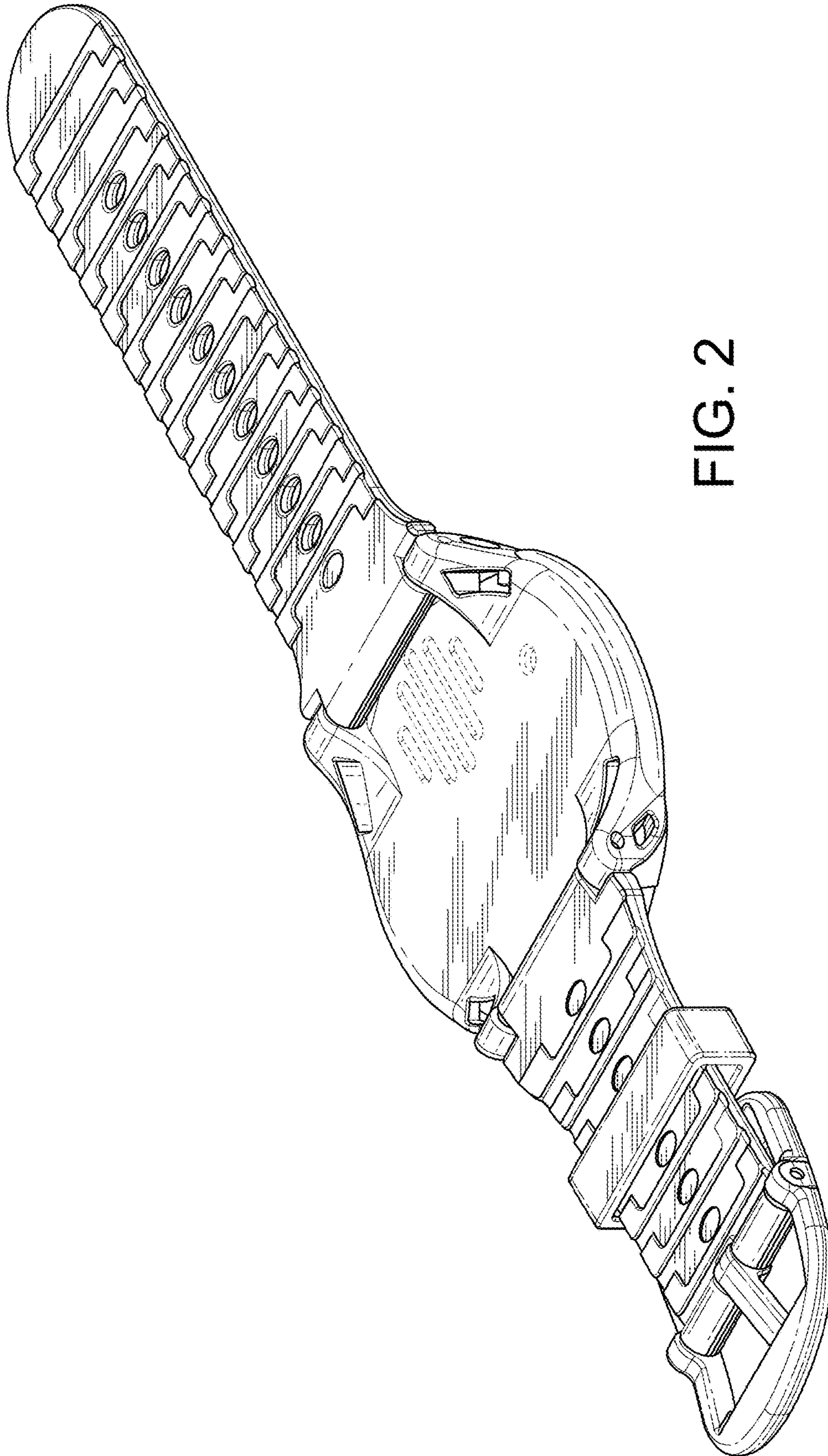

FIG. 2

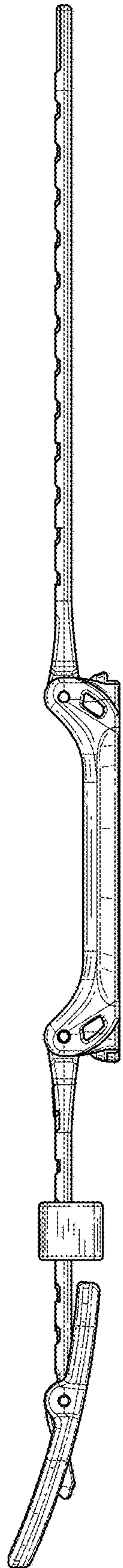

FIG. 3

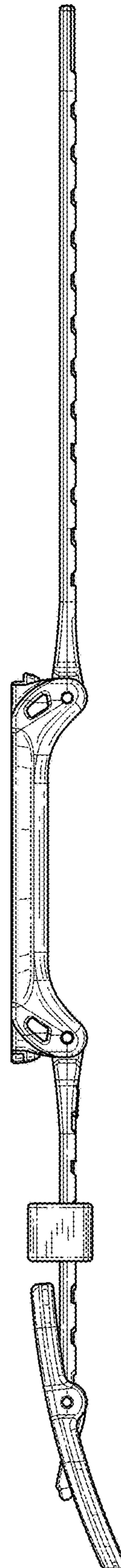

FIG. 4

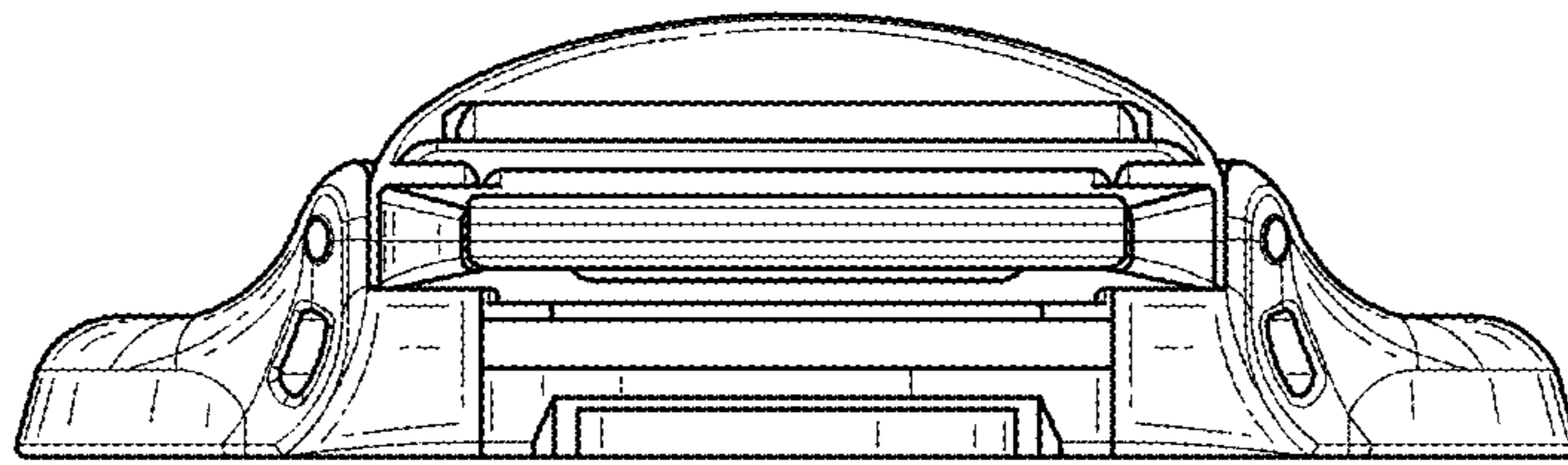

FIG. 6

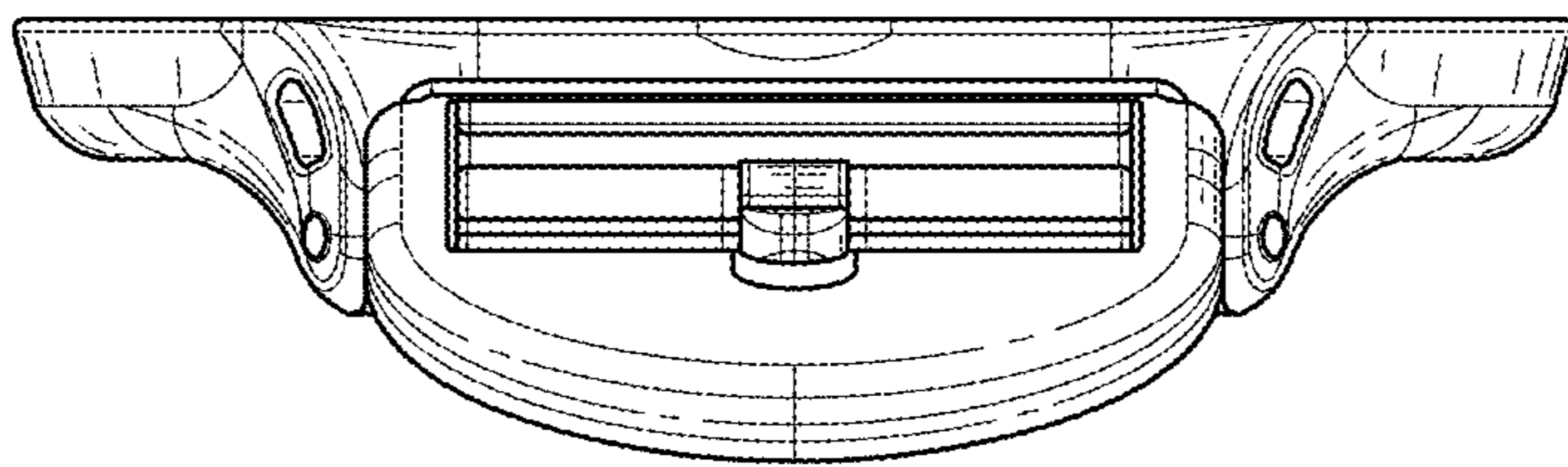

FIG. 5

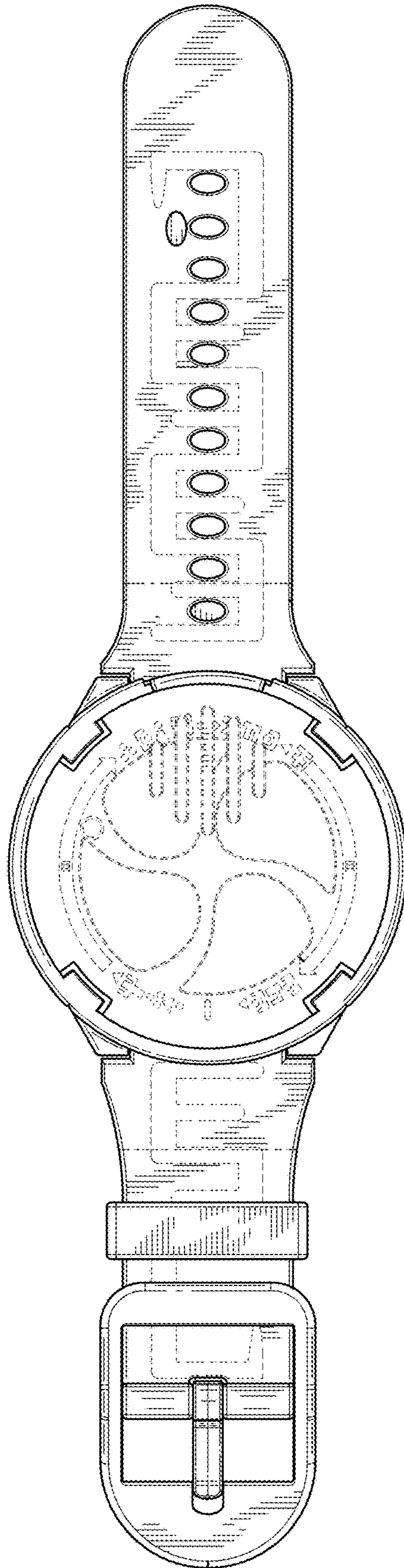

FIG. 7

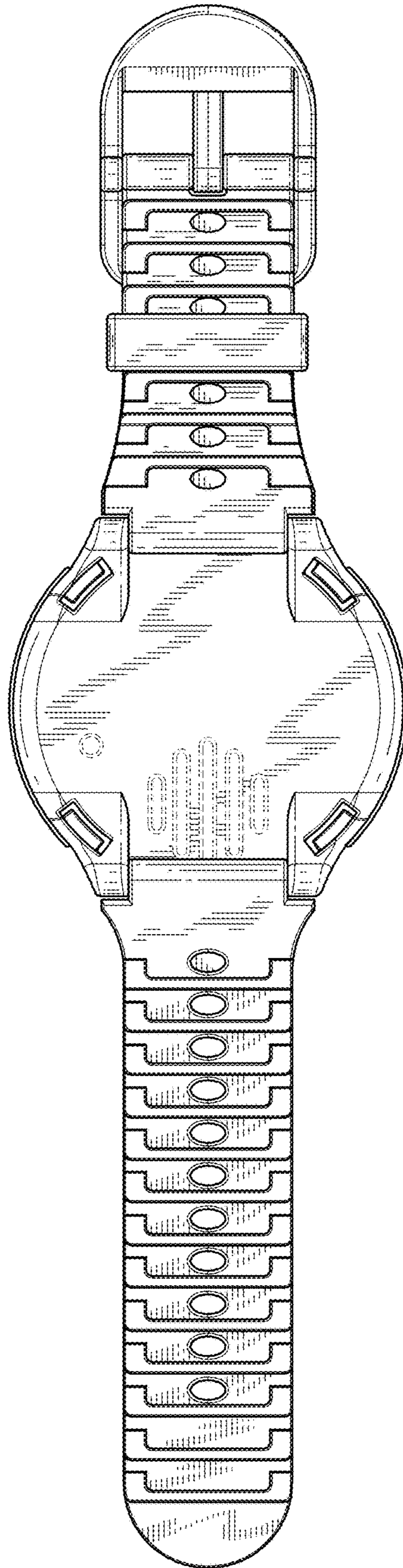

FIG. 8