



US00D776680S

(12) **United States Design Patent** (10) **Patent No.:** **US D776,680 S**
Bae et al. (45) **Date of Patent:** **** Jan. 17, 2017**

(54) **DISPLAY SCREEN OR PORTION THEREOF WITH ANIMATED GRAPHICAL USER INTERFACE**

(71) Applicant: **Samsung Electronics Co., Ltd.**, Suwon-si (KR)

(72) Inventors: **Soo-Jung Bae**, Seoul (KR); **Jin-Ki Jung**, Seongnam-si (KR)

(73) Assignee: **Samsung Electronics Co., Ltd.**, Suwon-si (KR)

(**) Term: **15 Years**

(21) Appl. No.: **29/529,463**

(22) Filed: **Jun. 8, 2015**

(30) **Foreign Application Priority Data**

Feb. 27, 2015 (KR) 30-2015-0010293

(51) **LOC (10) Cl.** **14-04**

(52) **U.S. Cl.**
USPC **D14/485; D14/489**

(58) **Field of Classification Search**
USPC D14/485-495
(Continued)

(56) **References Cited**

U.S. PATENT DOCUMENTS

D654,925 S * 2/2012 Nishizawa D14/488
D699,745 S * 2/2014 Pearson D14/488
(Continued)

FOREIGN PATENT DOCUMENTS

EM 001392153-0026 4/2014
EM 001392153-0027 4/2014
(Continued)

Primary Examiner — Deanna L Pratt

(74) *Attorney, Agent, or Firm* — NSIP Law

(57) **CLAIM**

We claim the ornamental design for a display screen or portion thereof with animated graphical user interface, as shown and described.

DESCRIPTION

FIG. 1 is the first image in a sequence for a display screen or portion thereof with animated graphical user interface showing our new design;

FIG. 2 is the second image thereof;

FIG. 3 is the third image thereof;

FIG. 4 is the fourth image thereof;

FIG. 5 is the fifth image thereof;

FIG. 6 is the sixth image thereof;

FIG. 7 is the seventh image thereof;

FIG. 8 is the eighth image thereof;

FIG. 9 is the first image in a sequence for the display screen or portion thereof with animated graphical user interface of FIG. 1 in which a display screen is provided in broken lines to illustrate an example environment;

FIG. 10 is the second image thereof;

FIG. 11 is the third image thereof;

FIG. 12 is the fourth image thereof;

FIG. 13 is the fifth image thereof;

FIG. 14 is the sixth image thereof;

FIG. 15 is the seventh image thereof; and,

FIG. 16 is the eighth image thereof.

The stippled shading of the display screen or portion thereof with animated graphical user interface shown in figures forms part of the claimed design.

The broken lines in the figures show portions of the display screen or portion thereof with animated graphical user interface which form no part of the claimed design.

The broken line showing of the display screen in FIGS. 9-16 are for environmental purposes only and form no part of the claimed design.

The dot dash lines in the figures represent an unclaimed boundary line and form no part of the claimed design.

The appearance of the animated graphical user interface sequentially transitions between the images shown in FIGS.

(Continued)

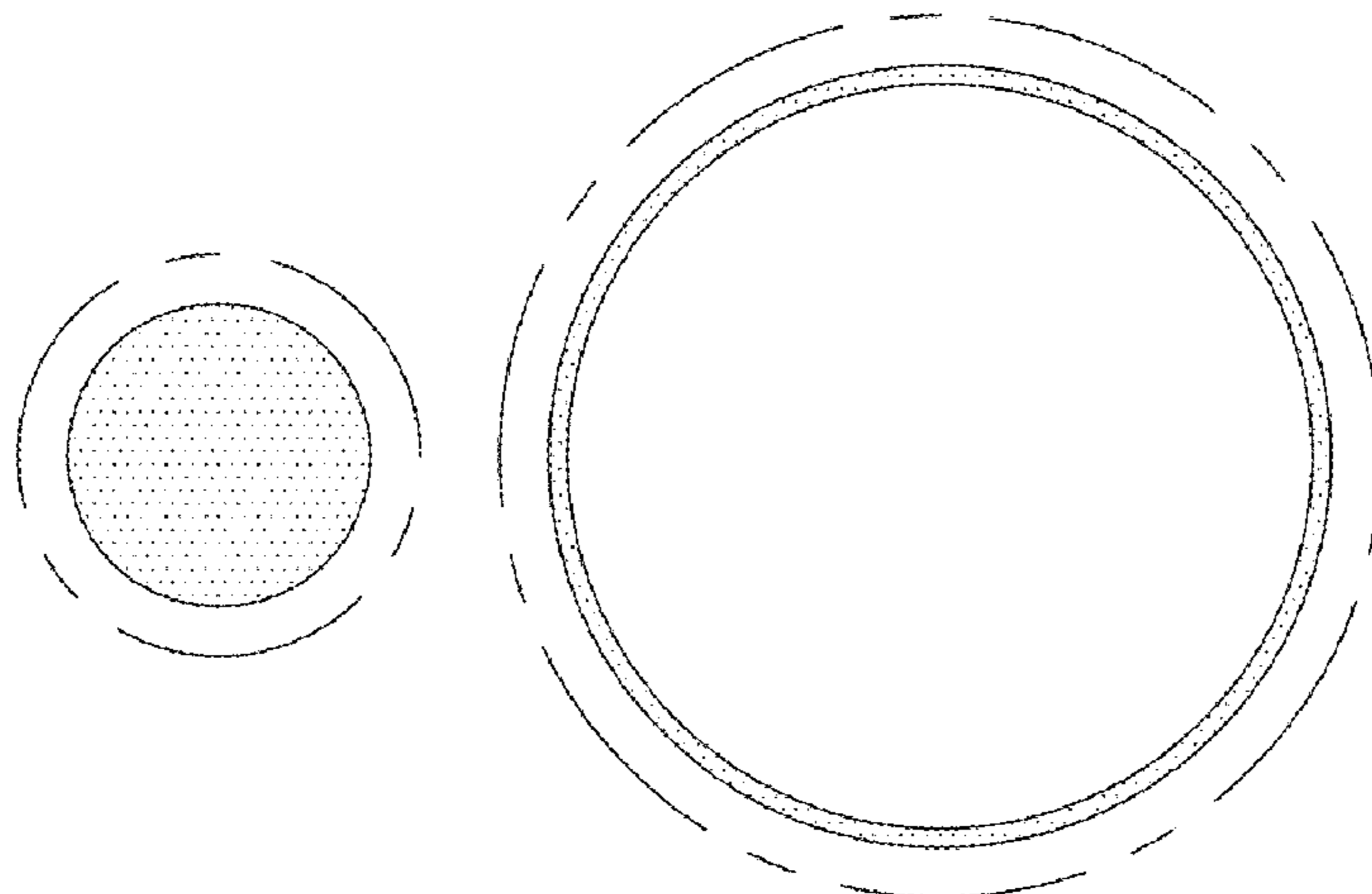

1-8 and in FIGS. 9-16. The process or period in which one image transitions to another forms no part of the claimed design.

1 Claim, 12 Drawing Sheets

(58) Field of Classification Search

CPC .. G06F 3/0481; G06F 3/0482; G06F 3/04817; G06F 3/04883; G06F 3/04815; G06F 3/0485; G06F 3/04886

See application file for complete search history.

(56)

References Cited

U.S. PATENT DOCUMENTS

D699,748 S * 2/2014 Pearson D14/488
D701,238 S * 3/2014 Lai D14/488

D725,674 S * 3/2015 Jung D14/488
D737,325 S * 8/2015 Kim D14/489
D753,151 S * 4/2016 Lee D14/485
D756,401 S * 5/2016 Soldner D14/488
D760,277 S * 6/2016 Park D14/489
D760,769 S * 7/2016 Ishii D14/488
D762,655 S * 8/2016 Kai D14/485
D762,673 S * 8/2016 Seo D14/485
D762,715 S * 8/2016 Williamson D14/488
D763,271 S * 8/2016 Everette D14/485
D763,306 S * 8/2016 Lee D14/488
D763,871 S * 8/2016 Yang D14/485

FOREIGN PATENT DOCUMENTS

EM 001392153-0028 4/2014
KR 30-2014-0023969 11/2014
KR 30-2014-0023972 11/2014

* cited by examiner

FIG. 1

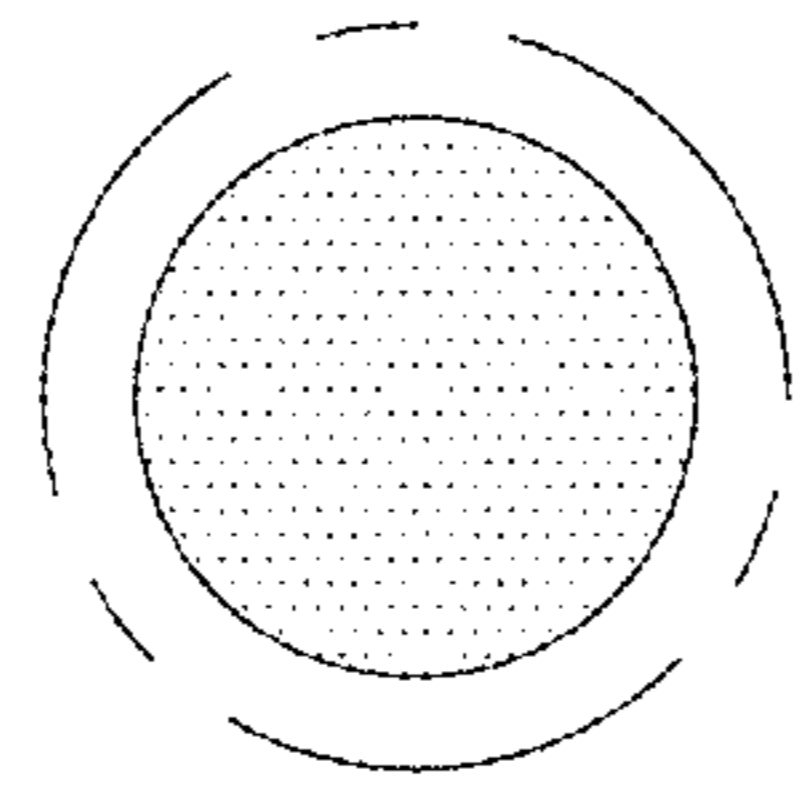

FIG. 2

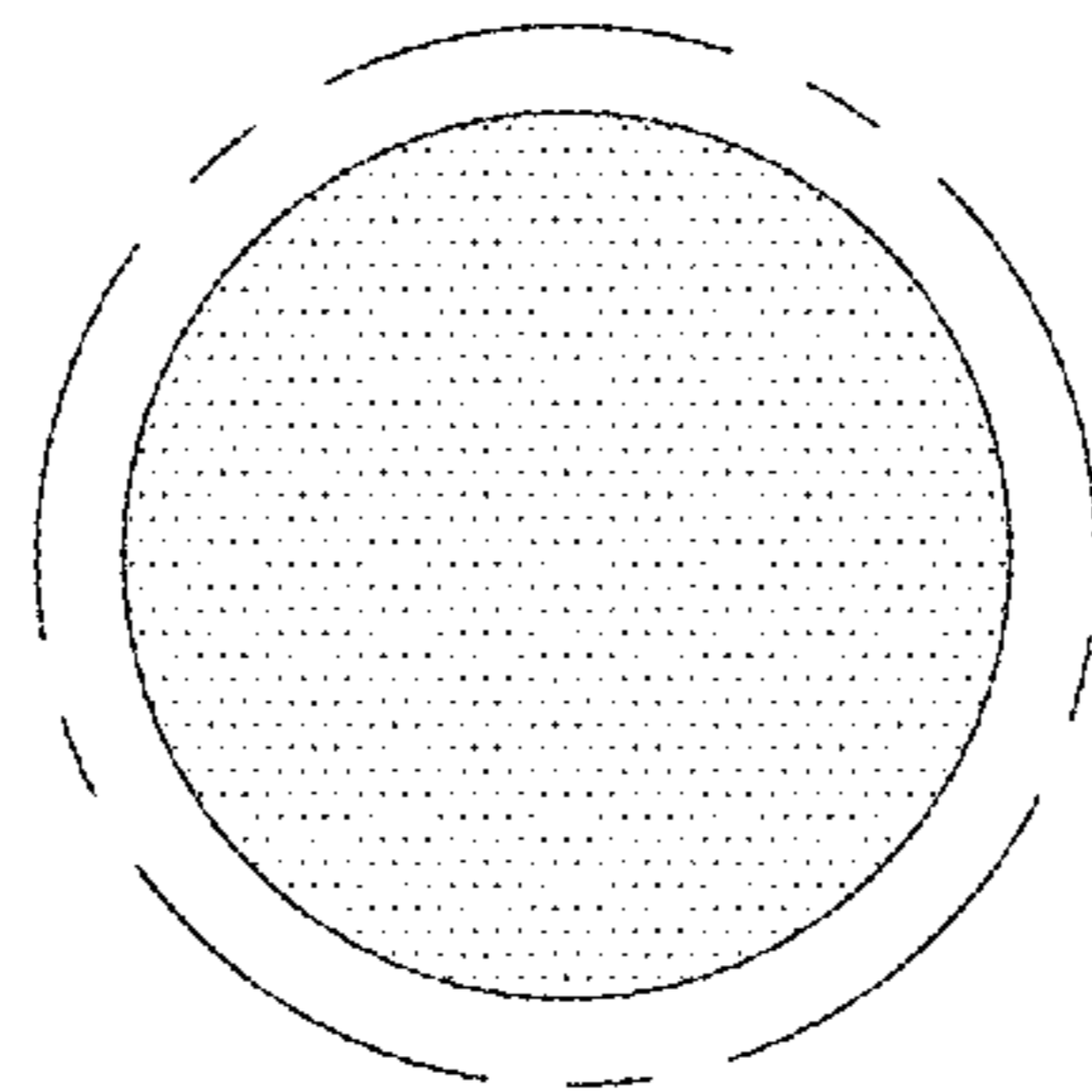

FIG. 3

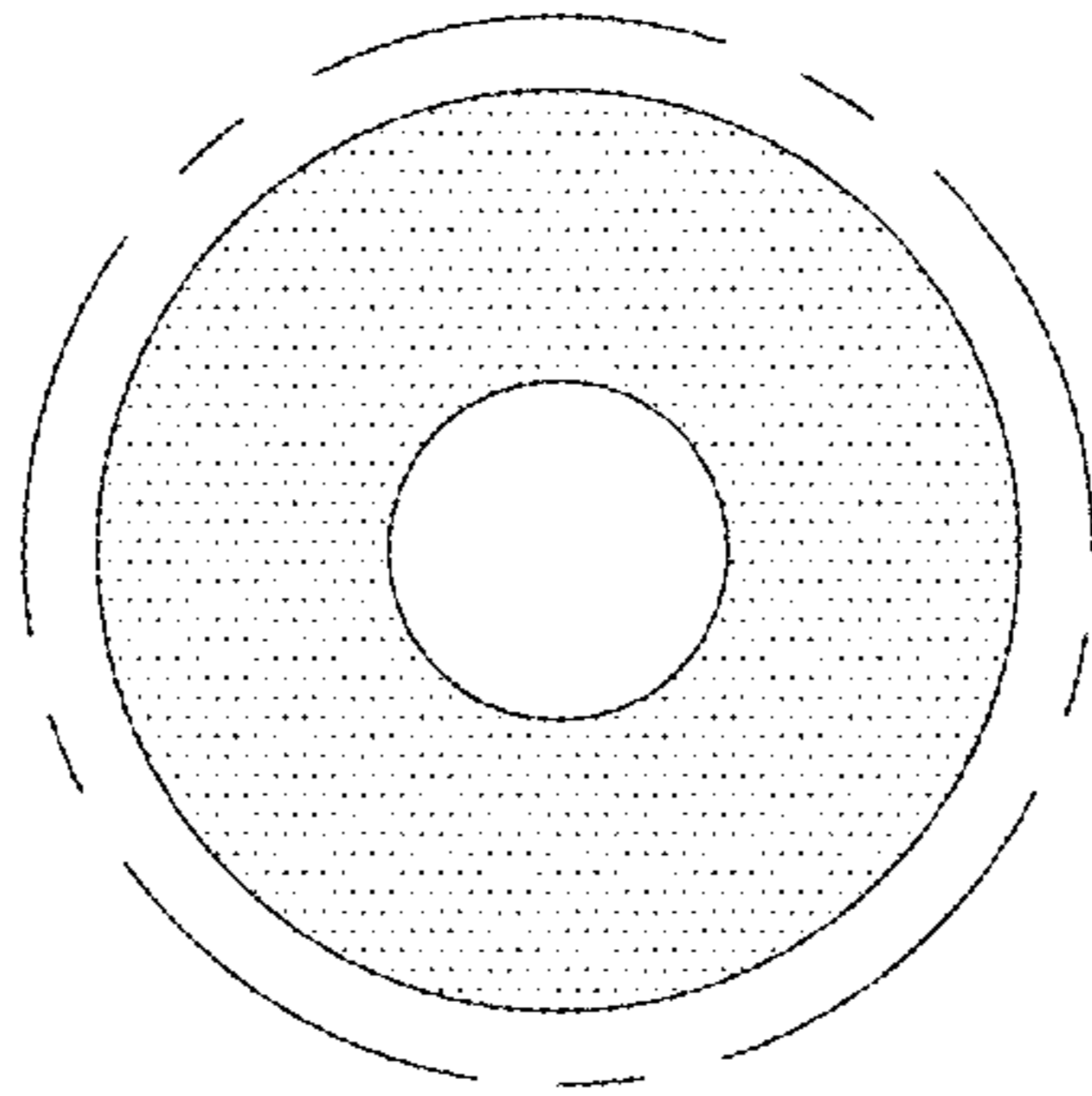

FIG. 4

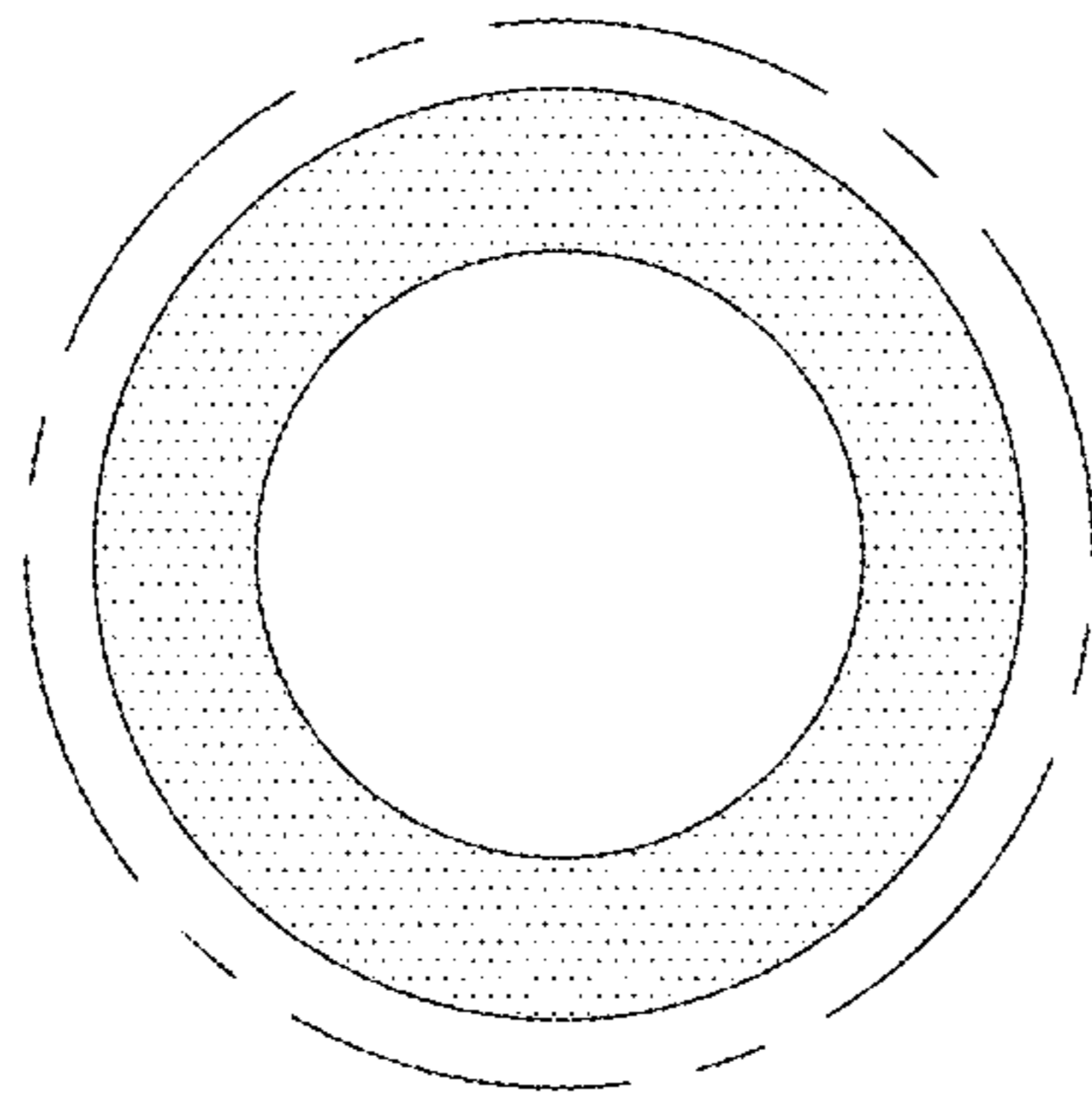

FIG. 5

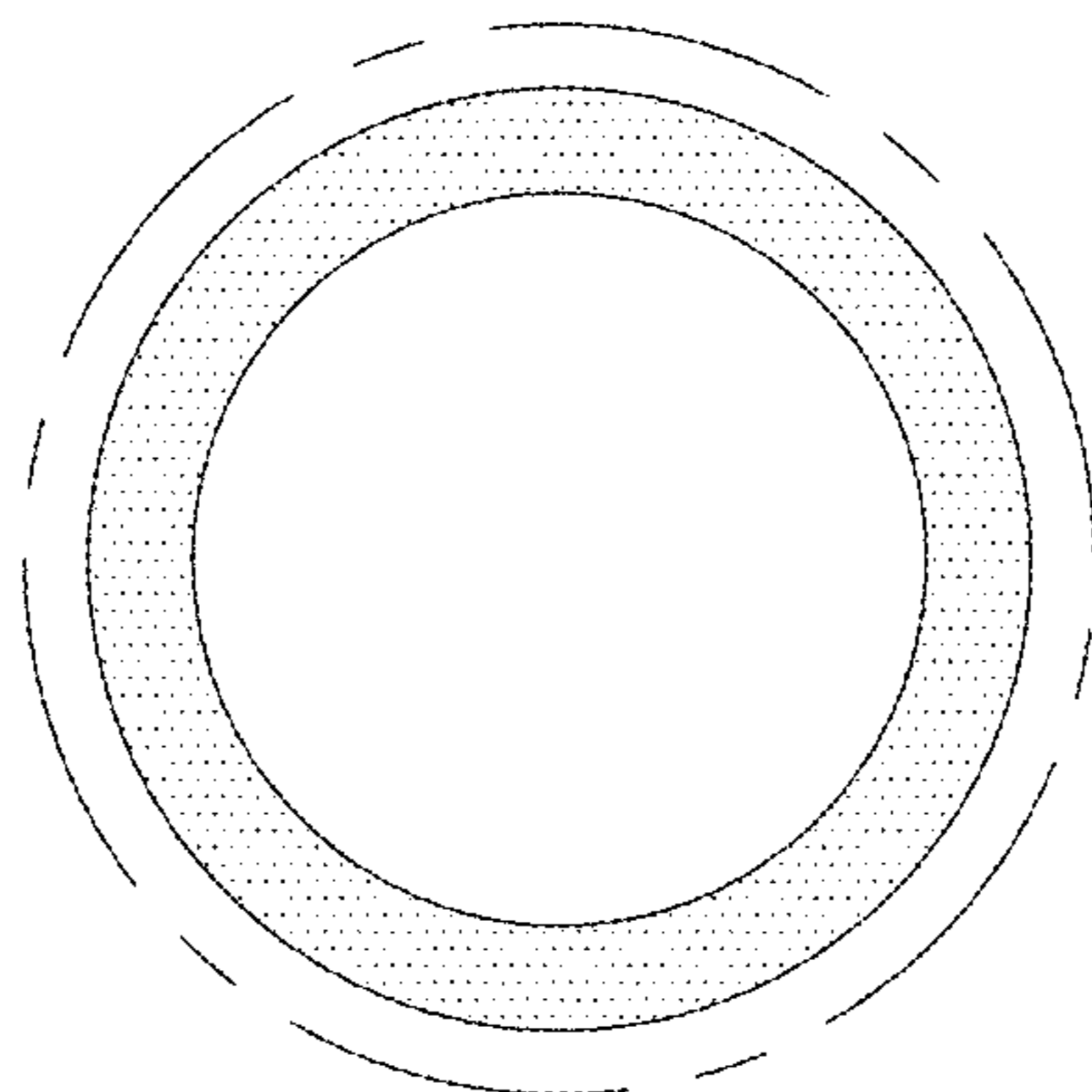

FIG. 6

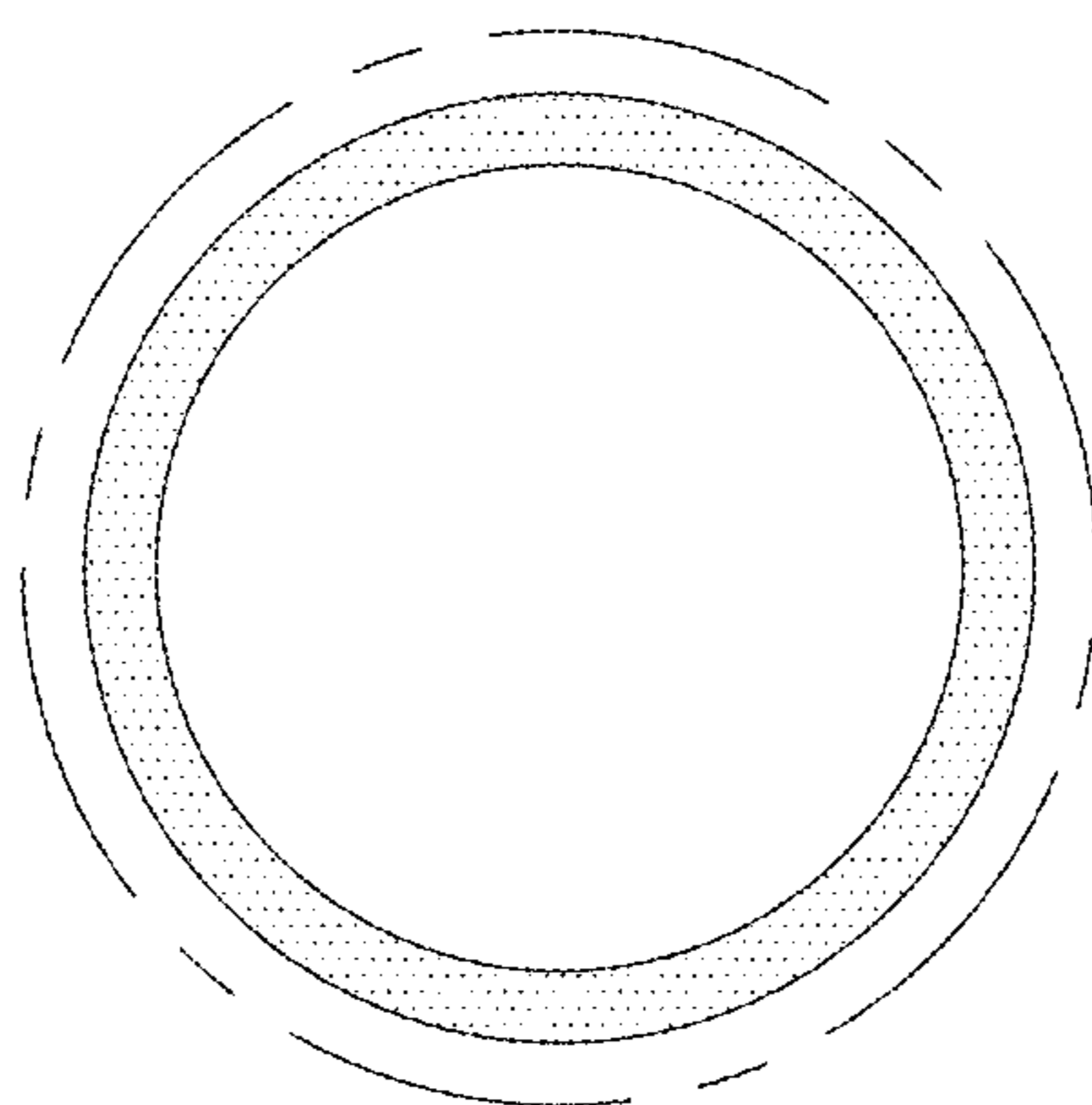

FIG. 7

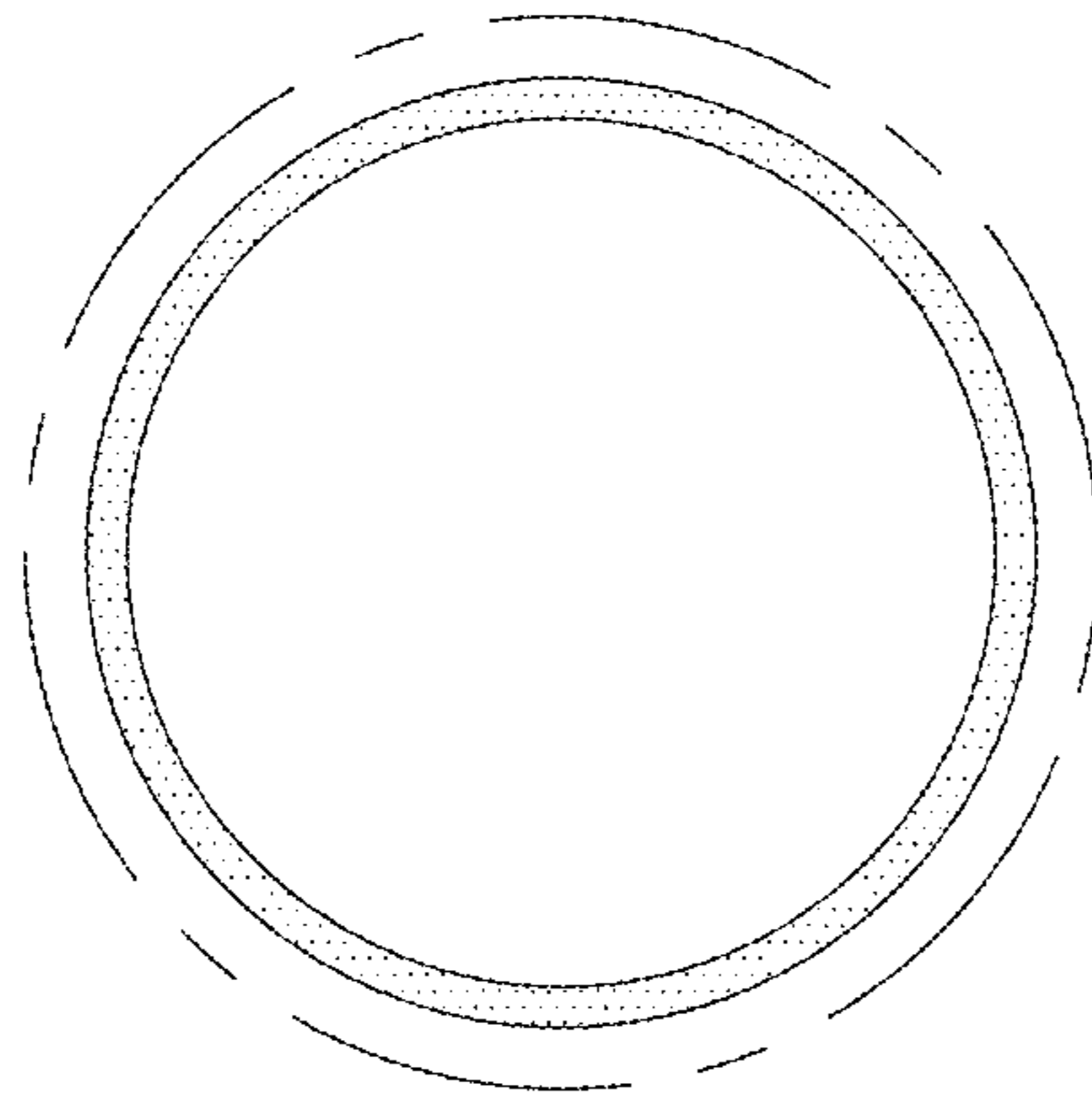

FIG. 8

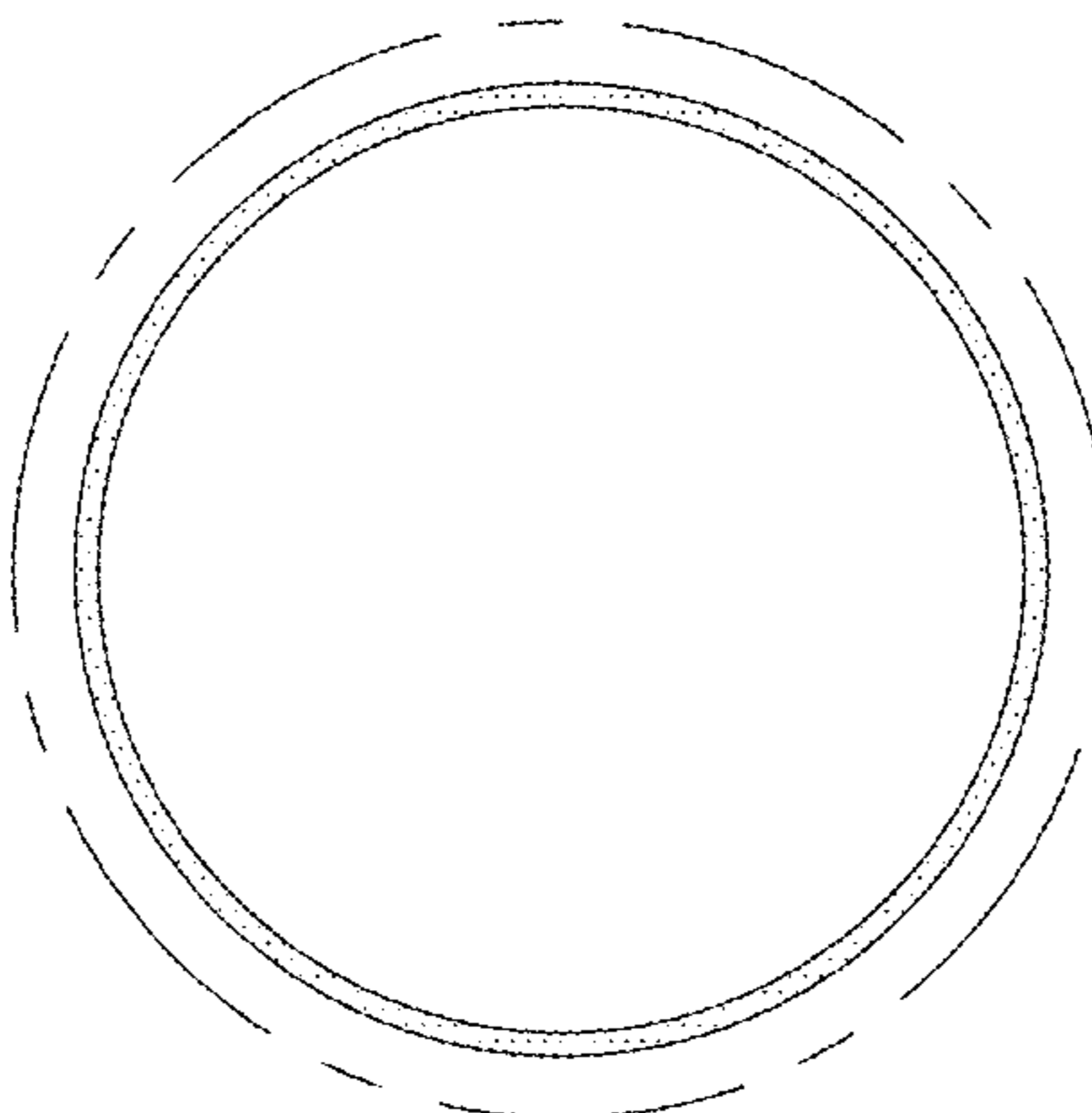

FIG. 10

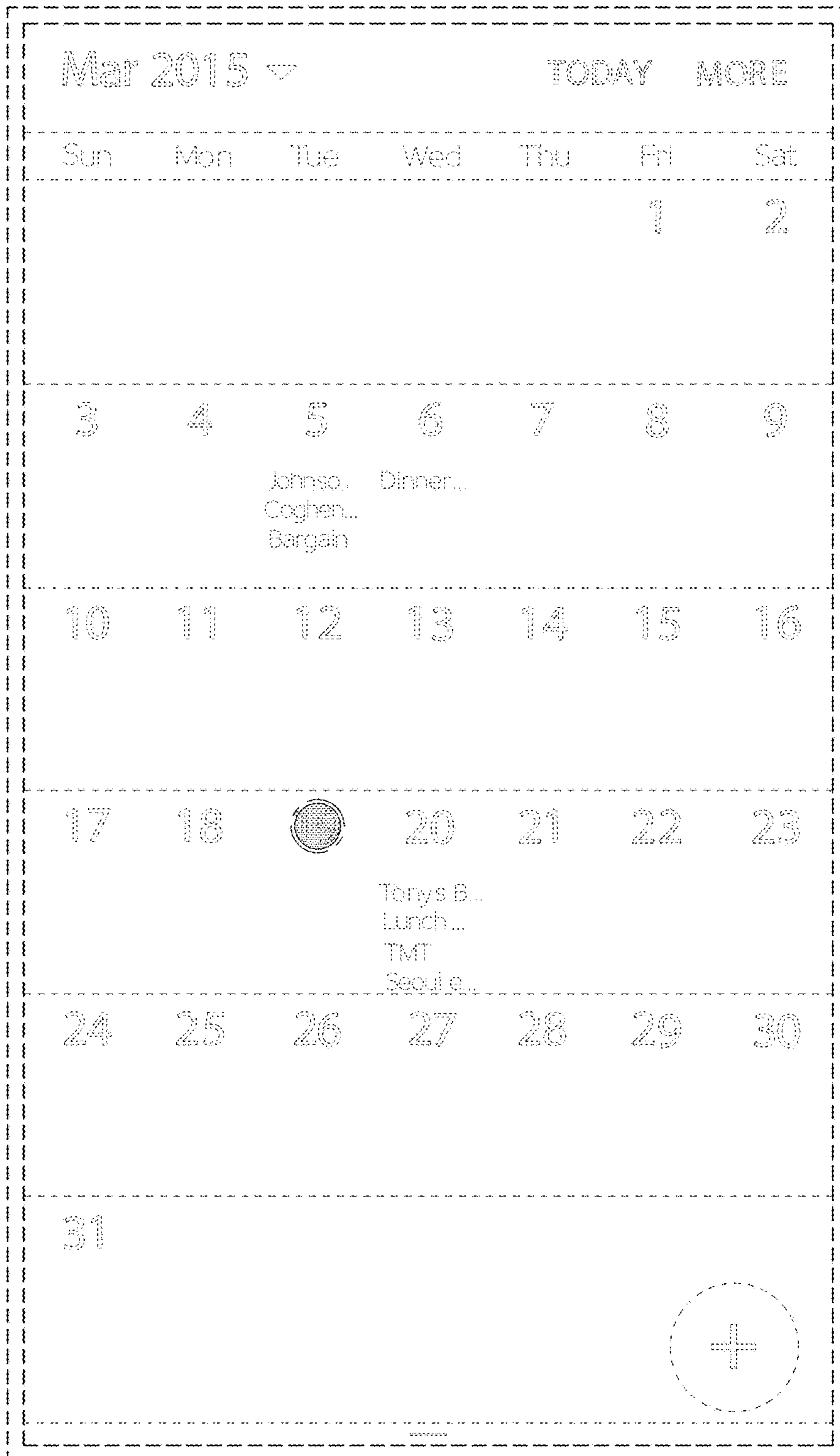

FIG. 11

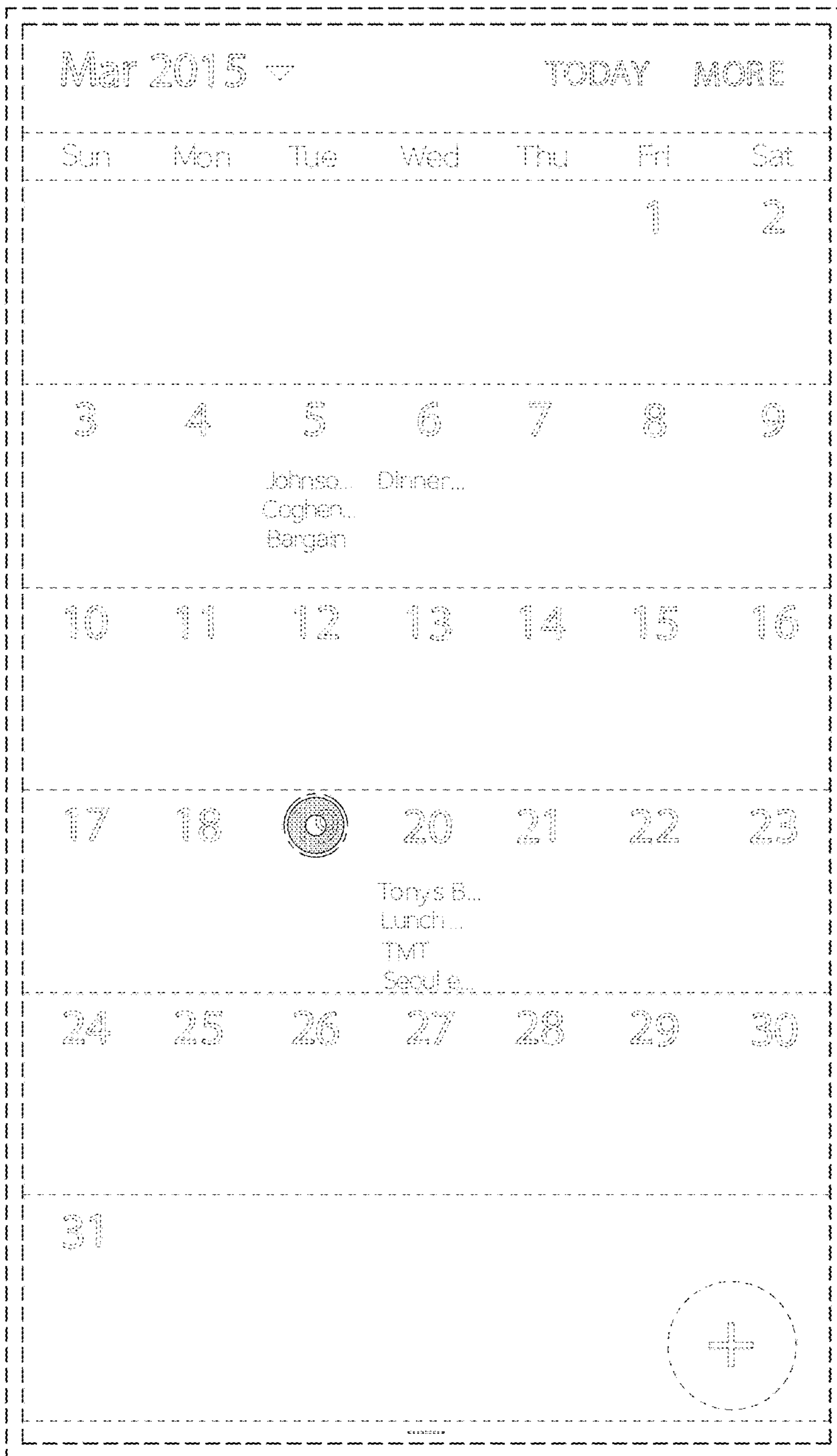

FIG. 12

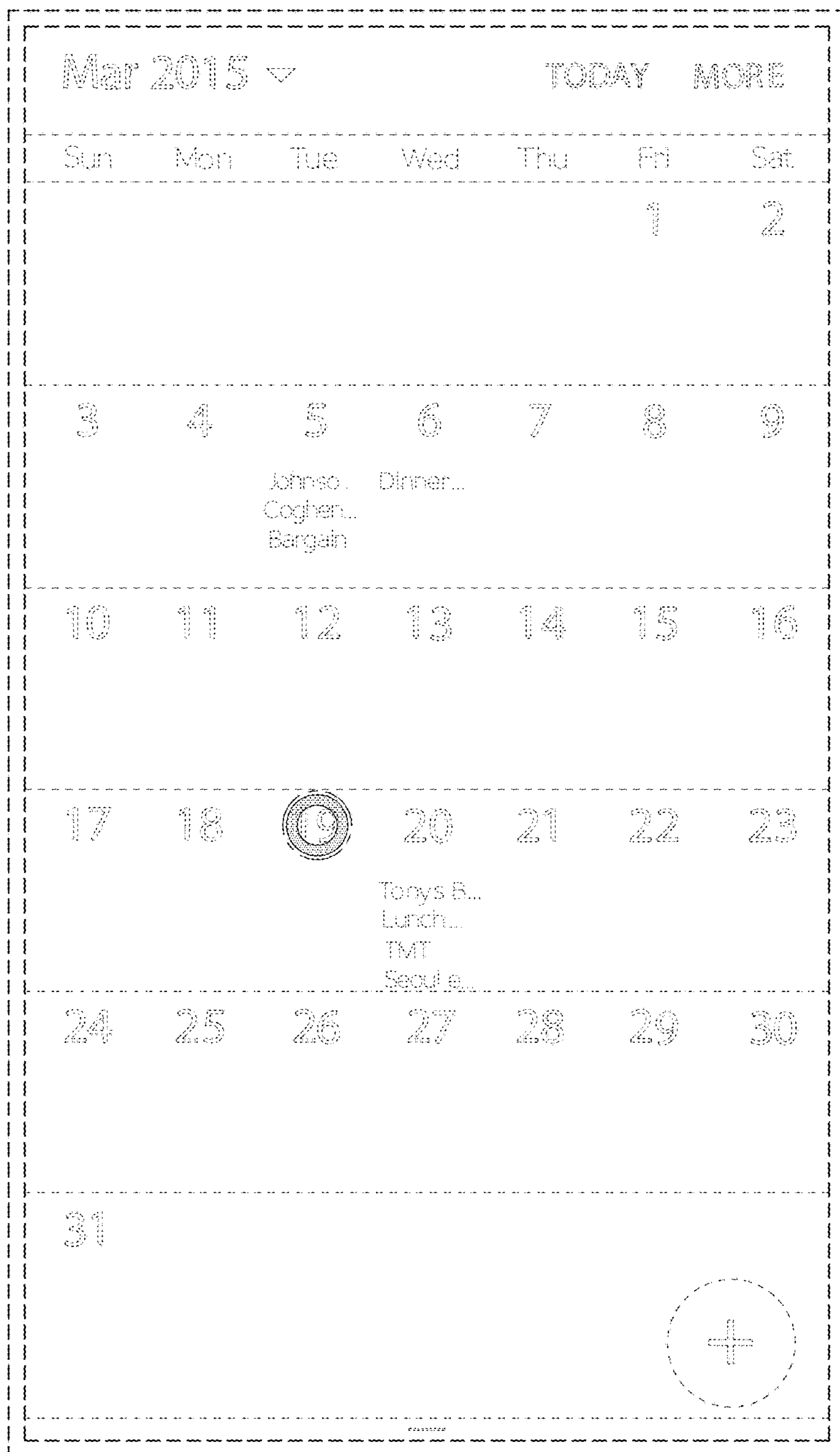

FIG. 13

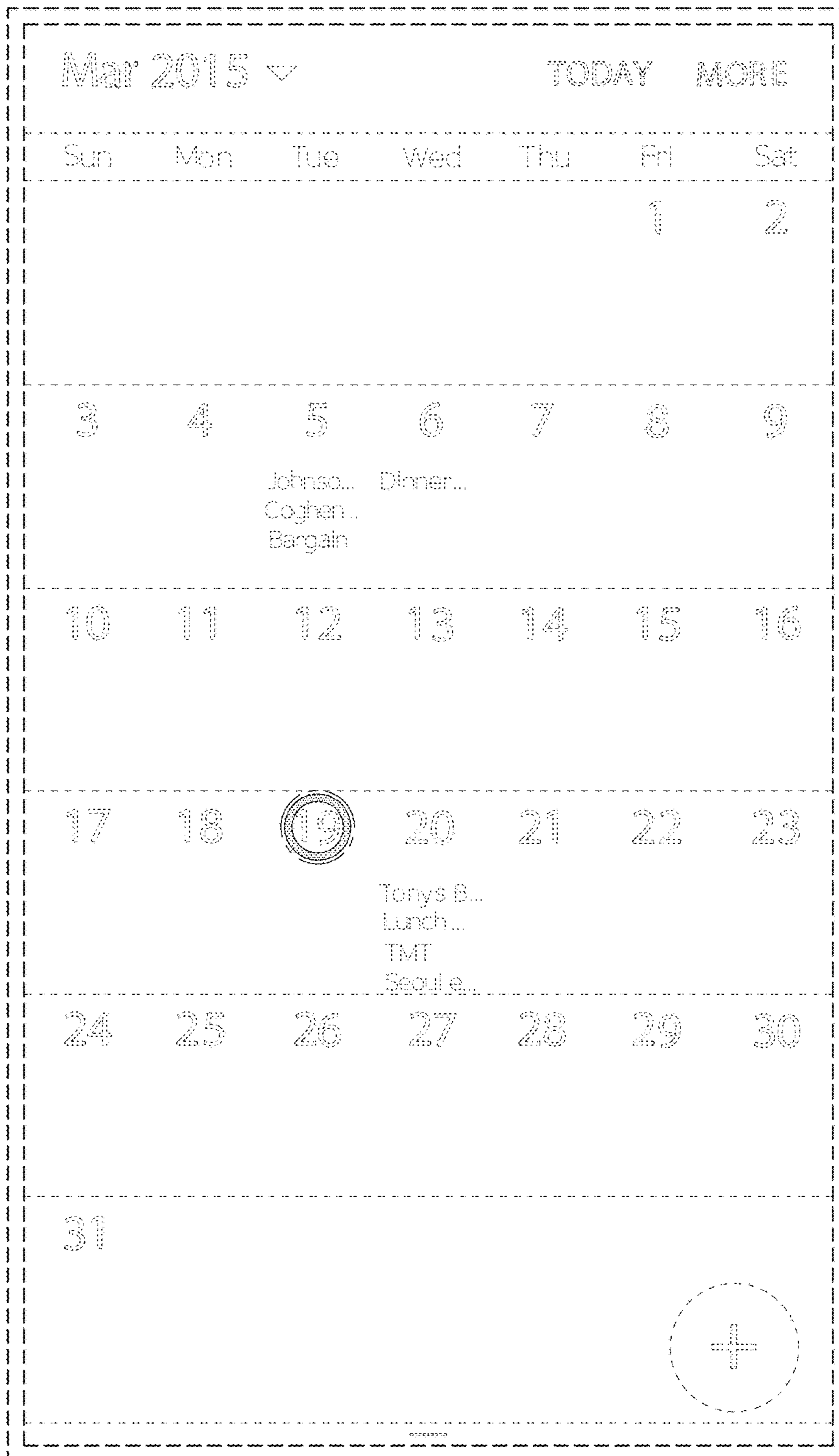

FIG. 15

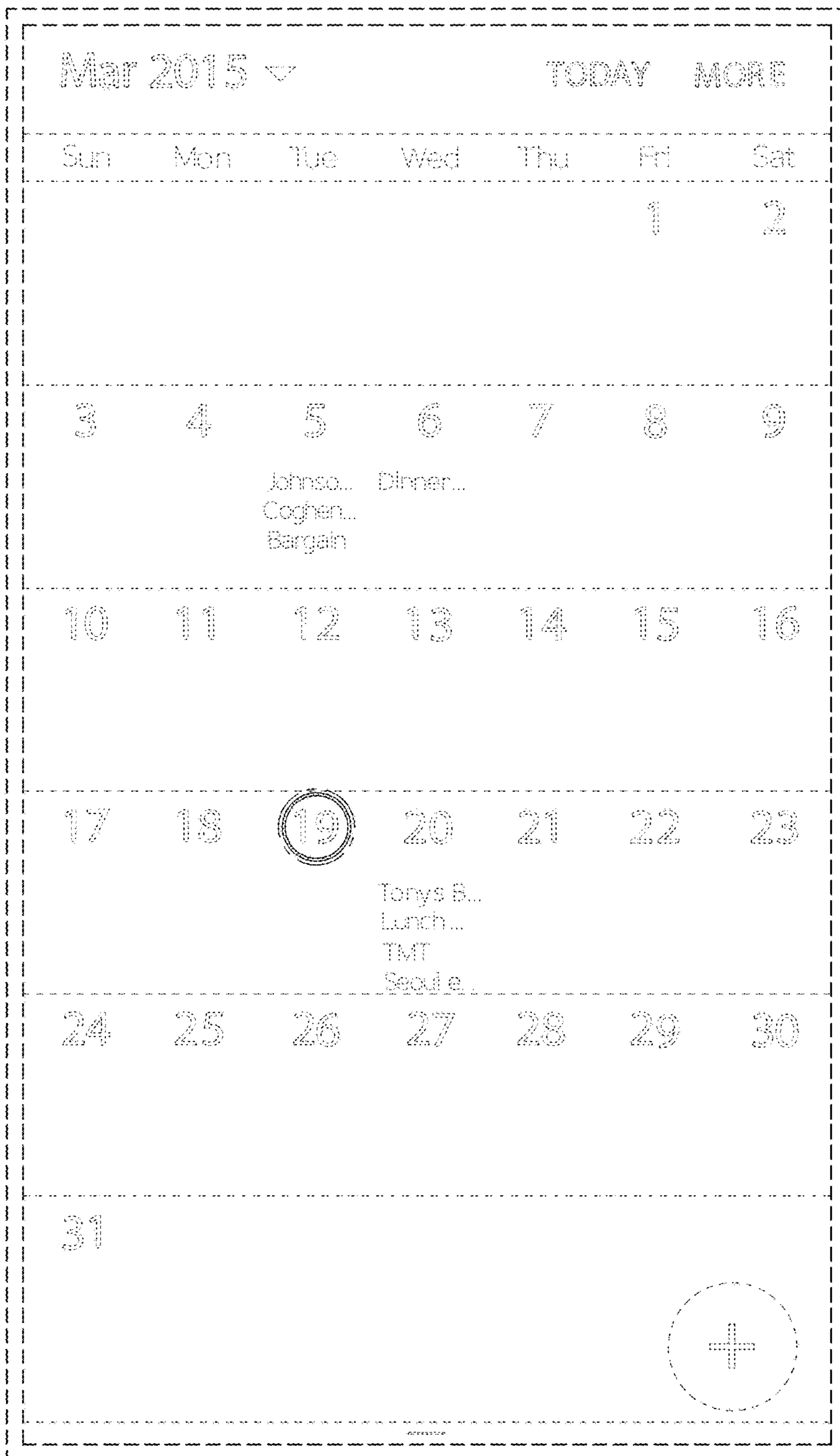

FIG. 16

