



US00D776673S

(12) **United States Design Patent** (10) **Patent No.:** **US D776,673 S**
Raykovich et al. (45) **Date of Patent:** **** *Jan. 17, 2017**

(54) **DISPLAY SCREEN WITH ANIMATED GRAPHICAL USER INTERFACE**

(71) Applicant: **Microsoft Corporation**, Redmond, WA (US)

(72) Inventors: **Christopher Raykovich**, Seattle, WA (US); **Jose Alberto Rodriguez**, Seattle, WA (US)

(73) Assignee: **Microsoft Corporation**, Redmond, WA (US)

(*) Notice: This patent is subject to a terminal disclaimer.

(**) Term: **14 Years**

(21) Appl. No.: **29/515,133**

(22) Filed: **Jan. 20, 2015**

(51) **LOC (10) Cl.** **14-04**

(52) **U.S. Cl.**
USPC **D14/485**

(58) **Field of Classification Search**
USPC D14/485-495

(Continued)

(56) **References Cited**

U.S. PATENT DOCUMENTS

D552,619 S * 10/2007 Sato D14/486
D552,621 S * 10/2007 Sato D14/486

(Continued)

OTHER PUBLICATIONS

U.S. Appl. No. 29/515,153, filed Jan. 20, 2015.
U.S. Appl. No. 29/515,086, filed Jan. 20, 2015.
U.S. Appl. No. 29/515,083, filed Jan. 20, 2015.

Primary Examiner — Robin V. Webster
Assistant Examiner — Rachel Voorhies
(74) *Attorney, Agent, or Firm* — Banner & Witcoff, Ltd.

(57) **CLAIM**

The ornamental design for a display screen with animated graphical user interface, as shown and described.

DESCRIPTION

FIG. 1 is the first image in a sequence for a display screen with animated graphical user interface showing our new design;

FIG. 2 is the second image thereof;

FIG. 3 is the third image thereof;

FIG. 4 is the fourth image thereof;

FIG. 5 is the fifth image thereof;

FIG. 6 is the sixth image thereof;

FIG. 7 is the seventh image thereof;

FIG. 8 is the eighth image thereof;

FIG. 9 is the ninth image thereof;

FIG. 10 is the tenth image thereof;

FIG. 11 is the eleventh image thereof;

FIG. 12 is the twelfth image thereof;

FIG. 13 is the thirteenth image thereof;

FIG. 14 is the fourteenth image thereof;

FIG. 15 is the fifteenth image thereof;

FIG. 16 is the sixteenth image thereof;

FIG. 17 is the seventeenth image thereof;

FIG. 18 is the eighteenth image thereof;

FIG. 19 is the nineteenth image thereof; and,

FIG. 20 is the twentieth image thereof.

The appearance of the animated graphical user interface sequentially transitions between the images shown in FIGS. 1-20. The process or period in which one image transitions to another forms no part of the claimed design. The broken line showing of the remainder of the user interface and the remainder of the display screen is for environmental purposes only and forms no part of the claimed design.

1 Claim, 20 Drawing Sheets

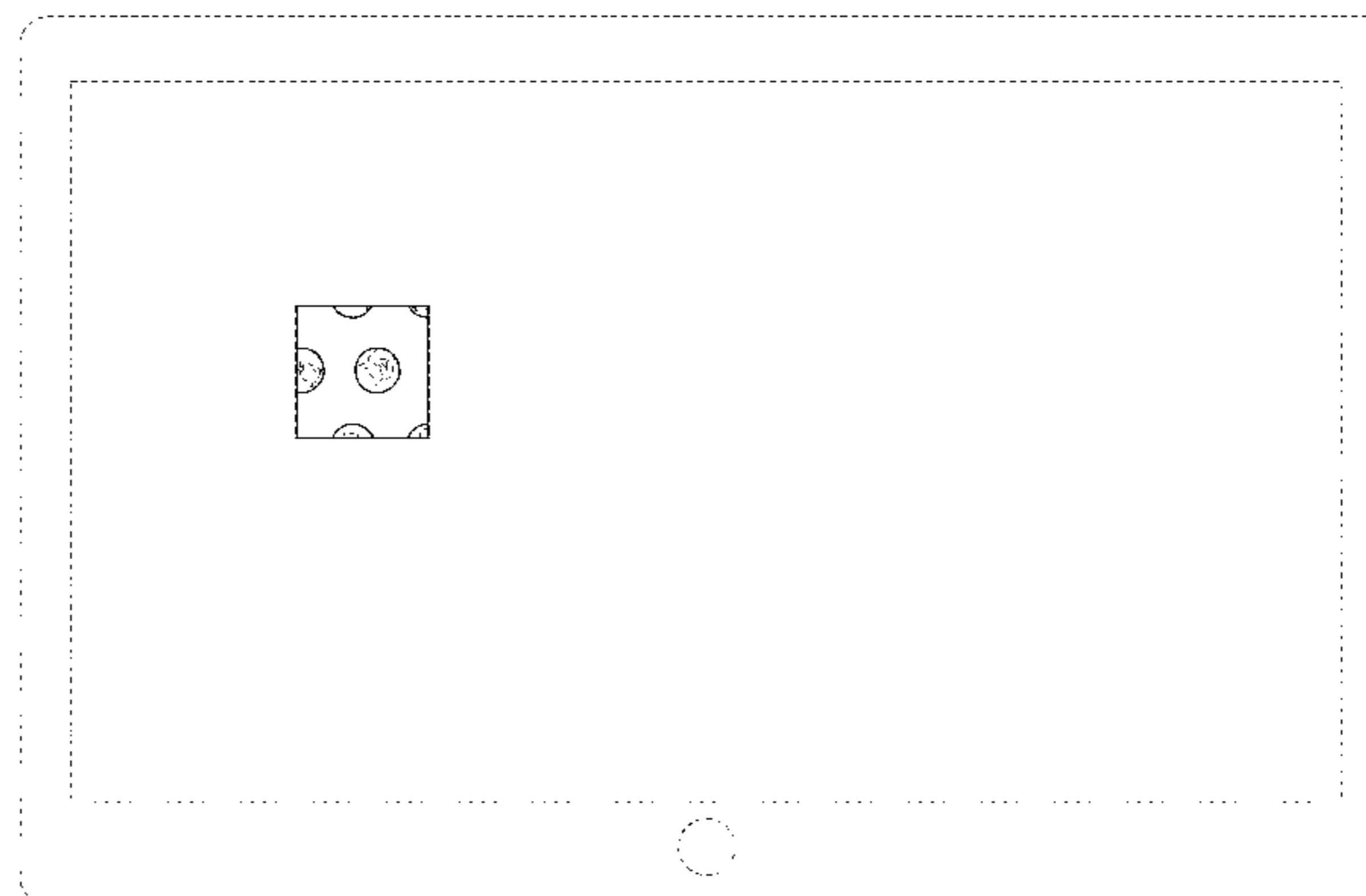
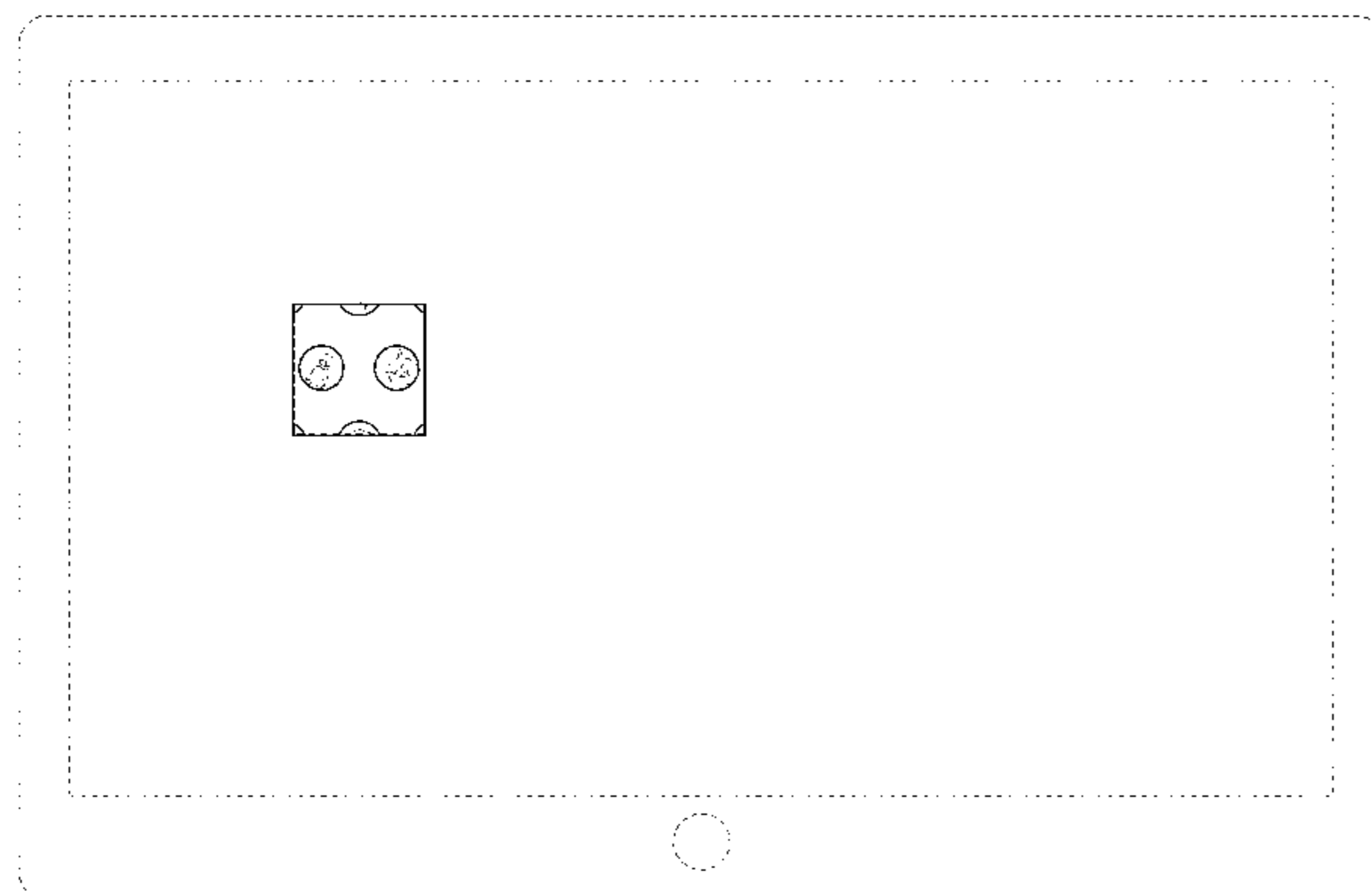

(58) **Field of Classification Search**
 CPC G06F 3/0482; H04L 41/145; H04L 51/32;
 G06Q 50/01; G06Q 10/063114; H04N
 1/00477; G06T 13/80; G06T 15/02
 See application file for complete search history.

(56) **References Cited**

U.S. PATENT DOCUMENTS

D582,934 S	*	12/2008	Byeon	D14/486
D619,593 S	*	7/2010	Fujioka	D14/485
D625,734 S	*	10/2010	Kurozumi	D14/488
D640,273 S	*	6/2011	Arnold	D14/487
D650,392 S	*	12/2011	Glezer	D14/486
D654,929 S	*	2/2012	Morrow	D14/492
D671,134 S	*	11/2012	Arnold	D14/487
D691,629 S	*	10/2013	Matas	D14/488
D698,810 S	*	2/2014	Misaki	D14/487
D699,250 S	*	2/2014	Fujii	D14/486
D717,332 S	*	11/2014	Nies	D14/486
D721,086 S	*	1/2015	Hontz, Jr.	D14/485
D740,307 S	*	10/2015	McAllister	D14/486

D752,105 S	*	3/2016	Lee	D14/494
2012/0081356 A1	*	4/2012	Filippov	G06T 19/20 345/419
2013/0290139 A1	*	10/2013	Stark	G06T 13/40 705/26.61
2013/0328888 A1	*	12/2013	Beaver	G06T 19/00 345/473
2014/0019892 A1	*	1/2014	Mayerhofer	G06F 9/4443 715/763
2015/0082243 A1	*	3/2015	Taylor	G06F 3/0482 715/814
2015/0378564 A1	*	12/2015	Ramanathan	G06T 11/206 715/738
2016/0011742 A1	*	1/2016	Fujioka	G06F 3/04817 715/811
2016/0012739 A1	*	1/2016	Jafari	G09B 5/06 434/353
2016/0054892 A1	*	2/2016	Kim	G06F 3/04817 715/808
2016/0062570 A1	*	3/2016	Dascola	G06F 3/0482 715/765

* cited by examiner

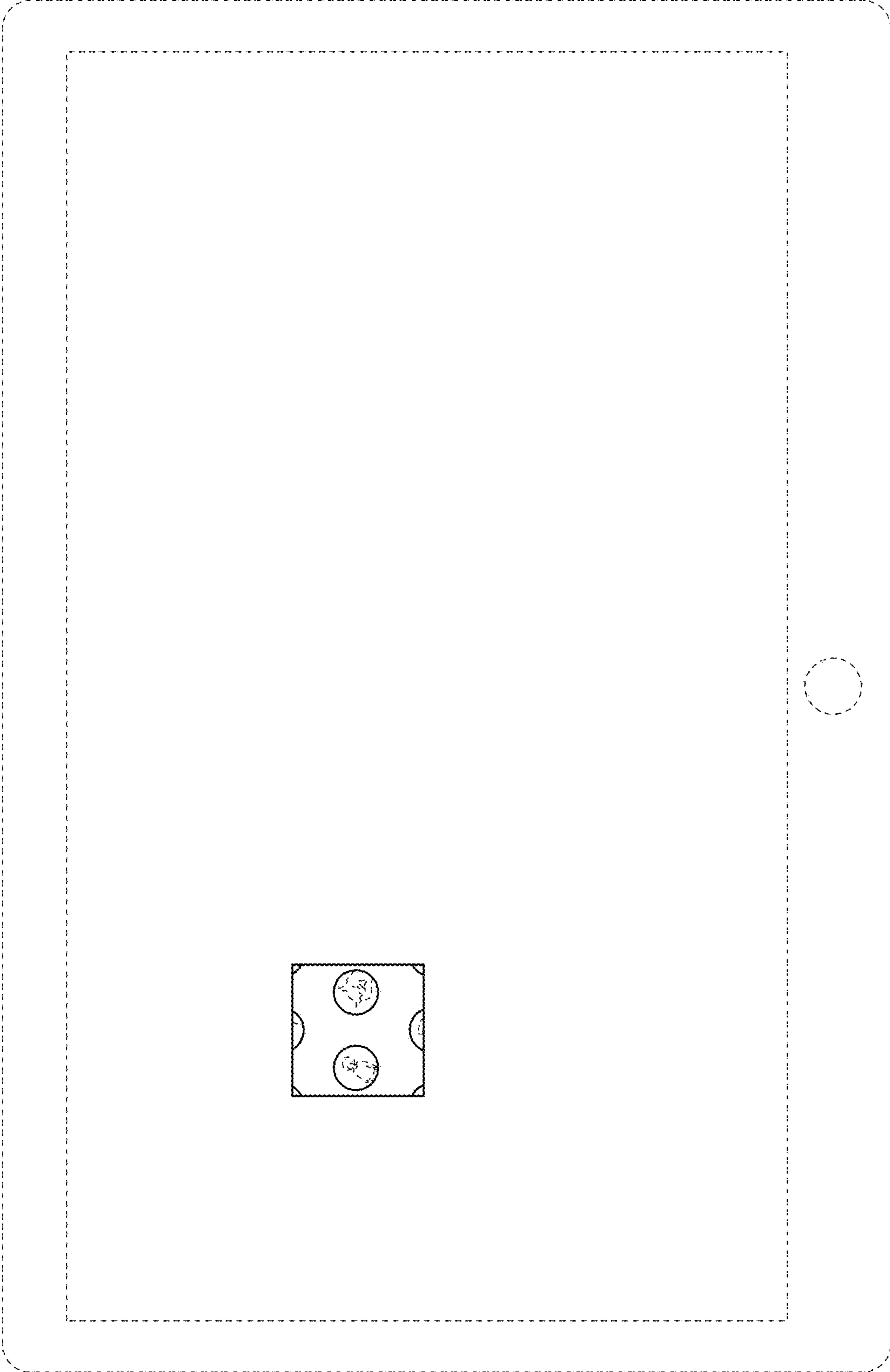

FIG. 1

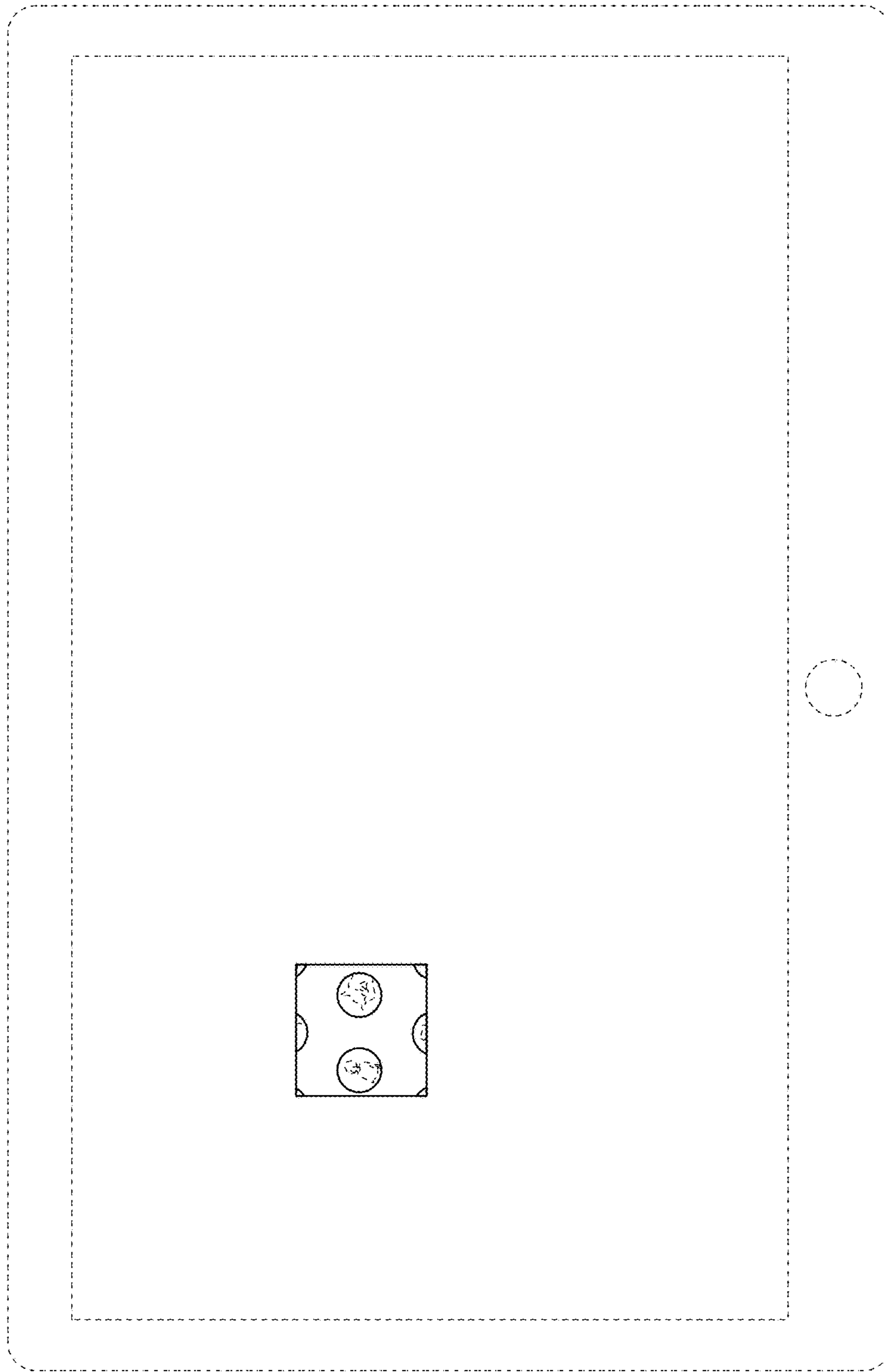

FIG. 2

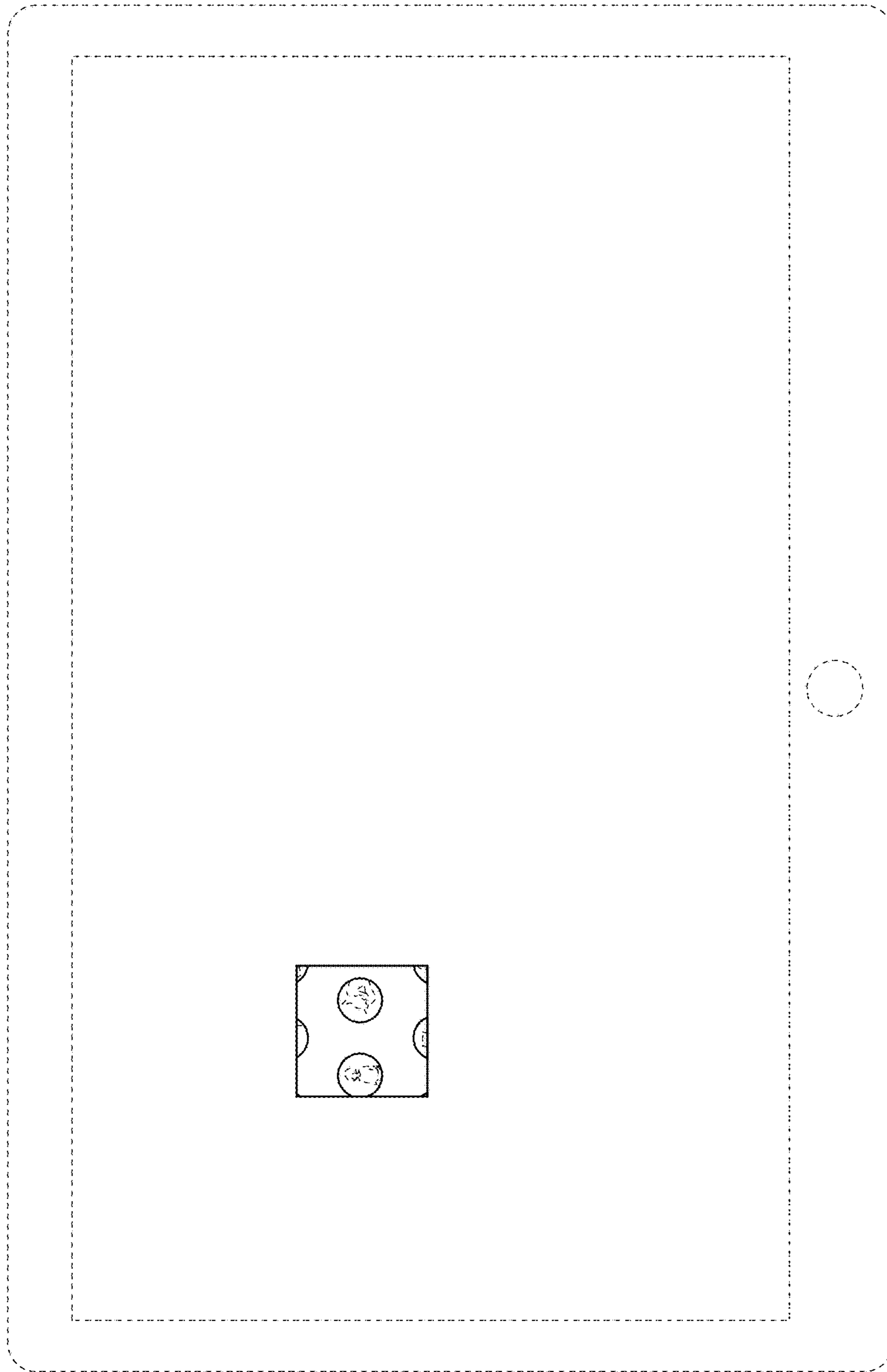

FIG. 3

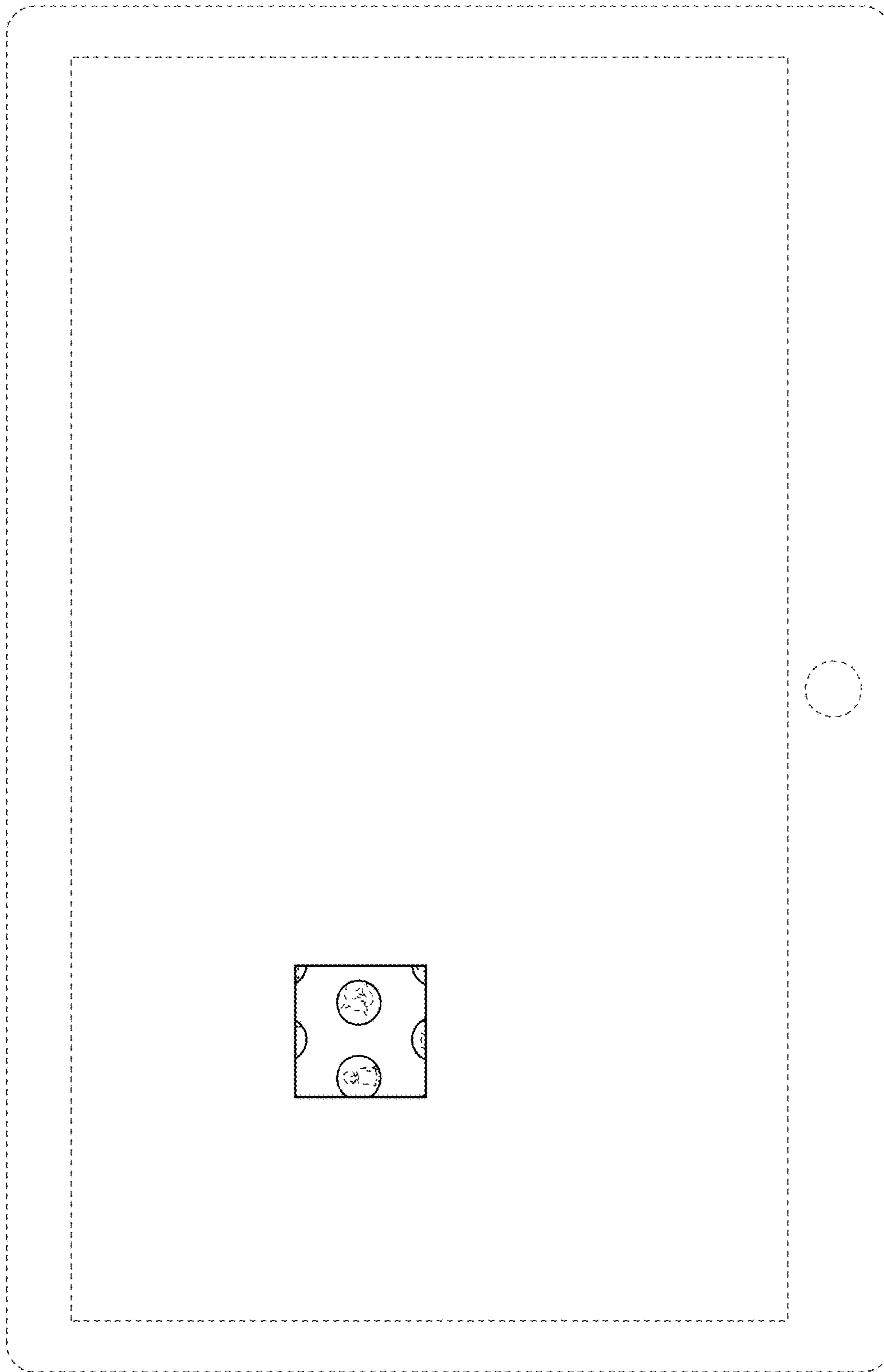

FIG. 4

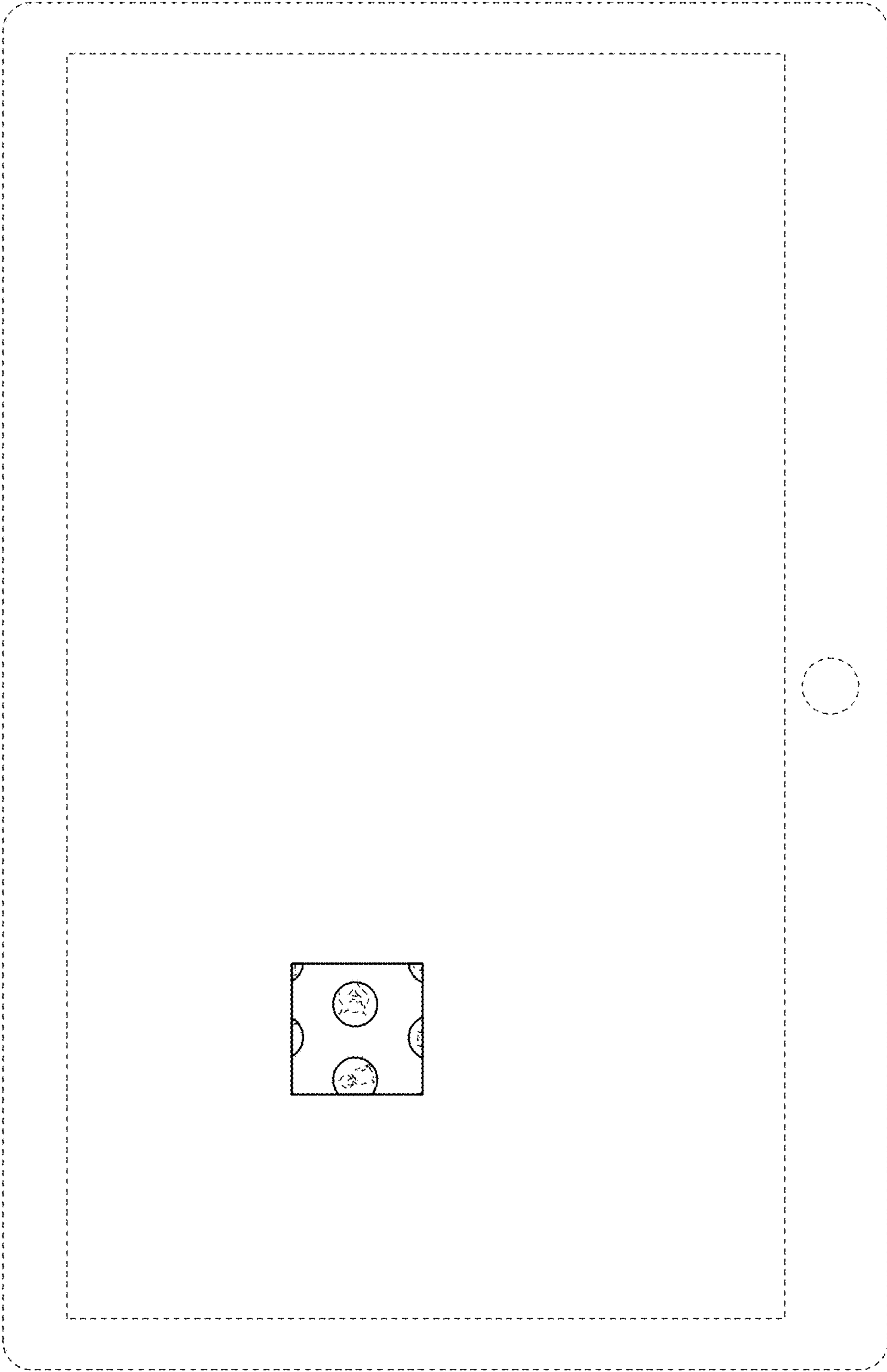

FIG. 5

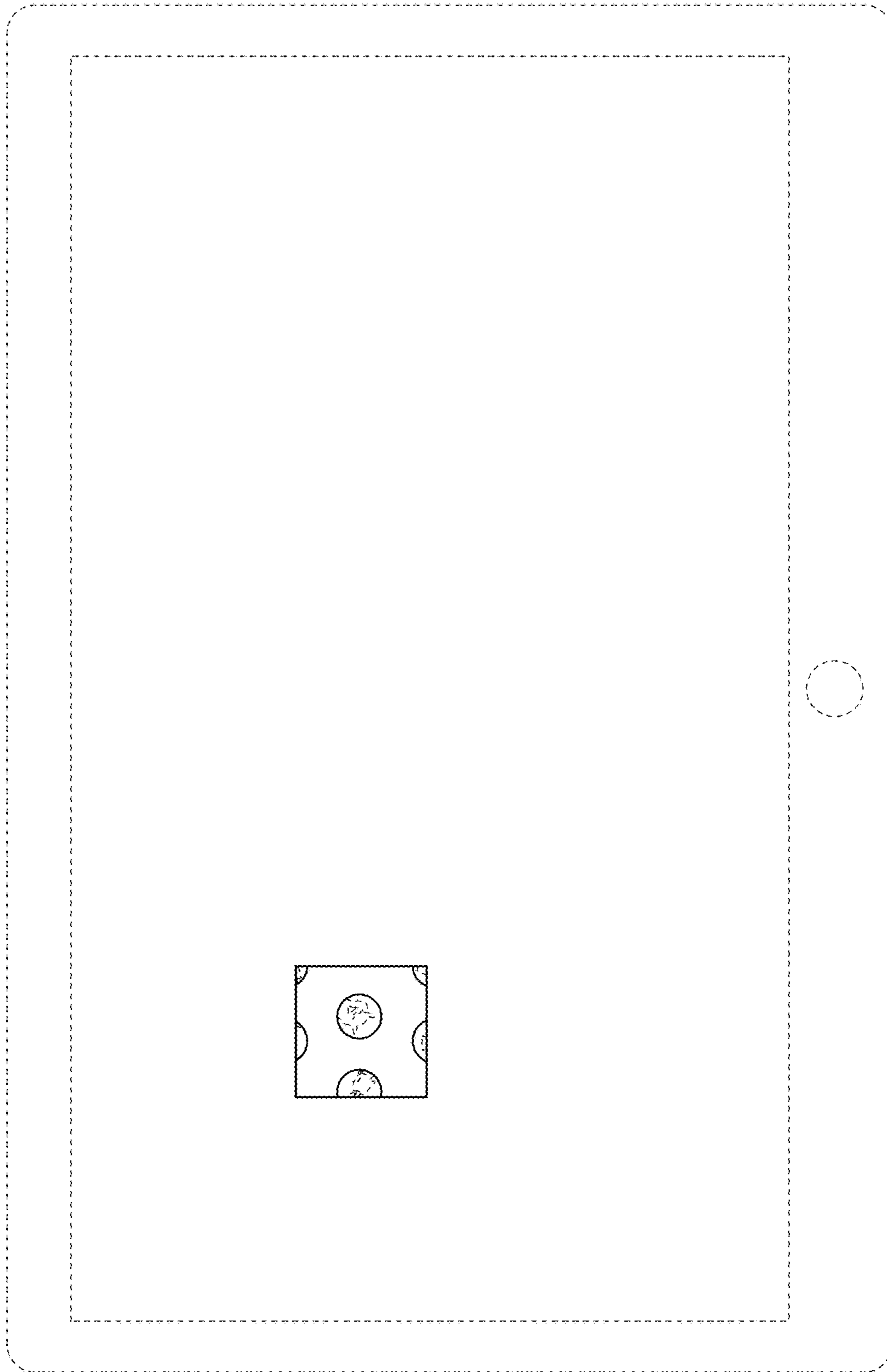

FIG. 6

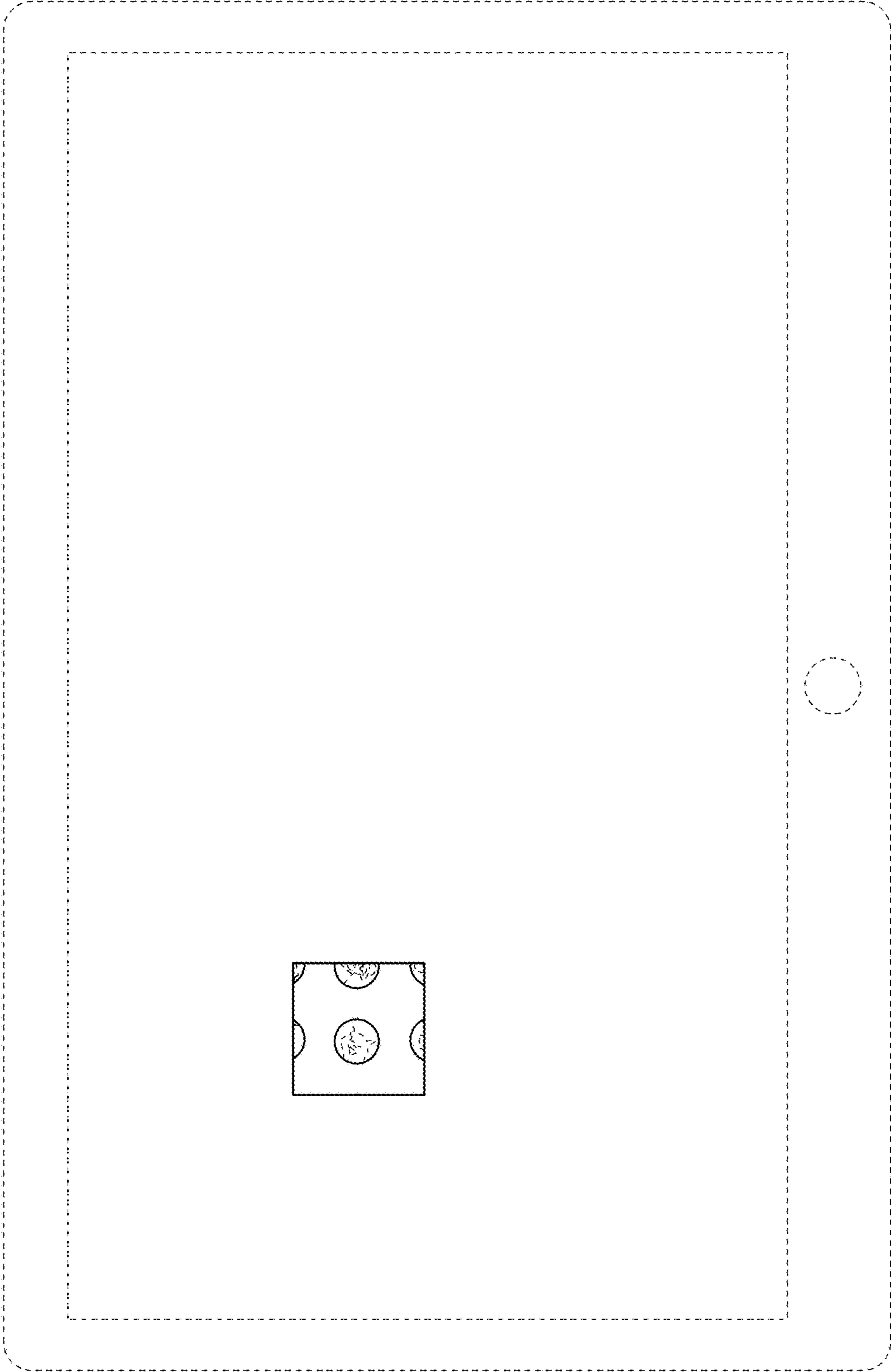

FIG. 7

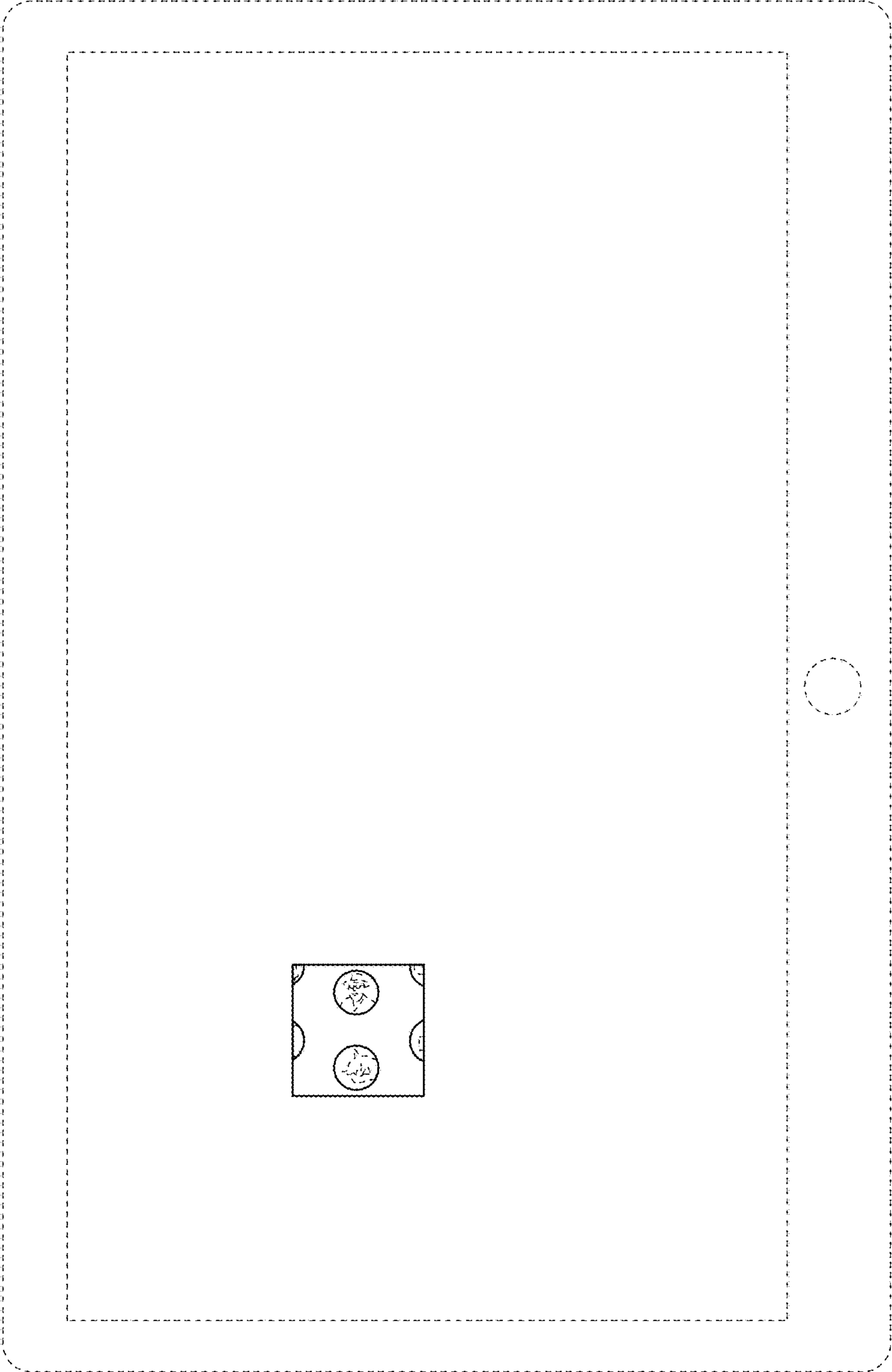

FIG. 8

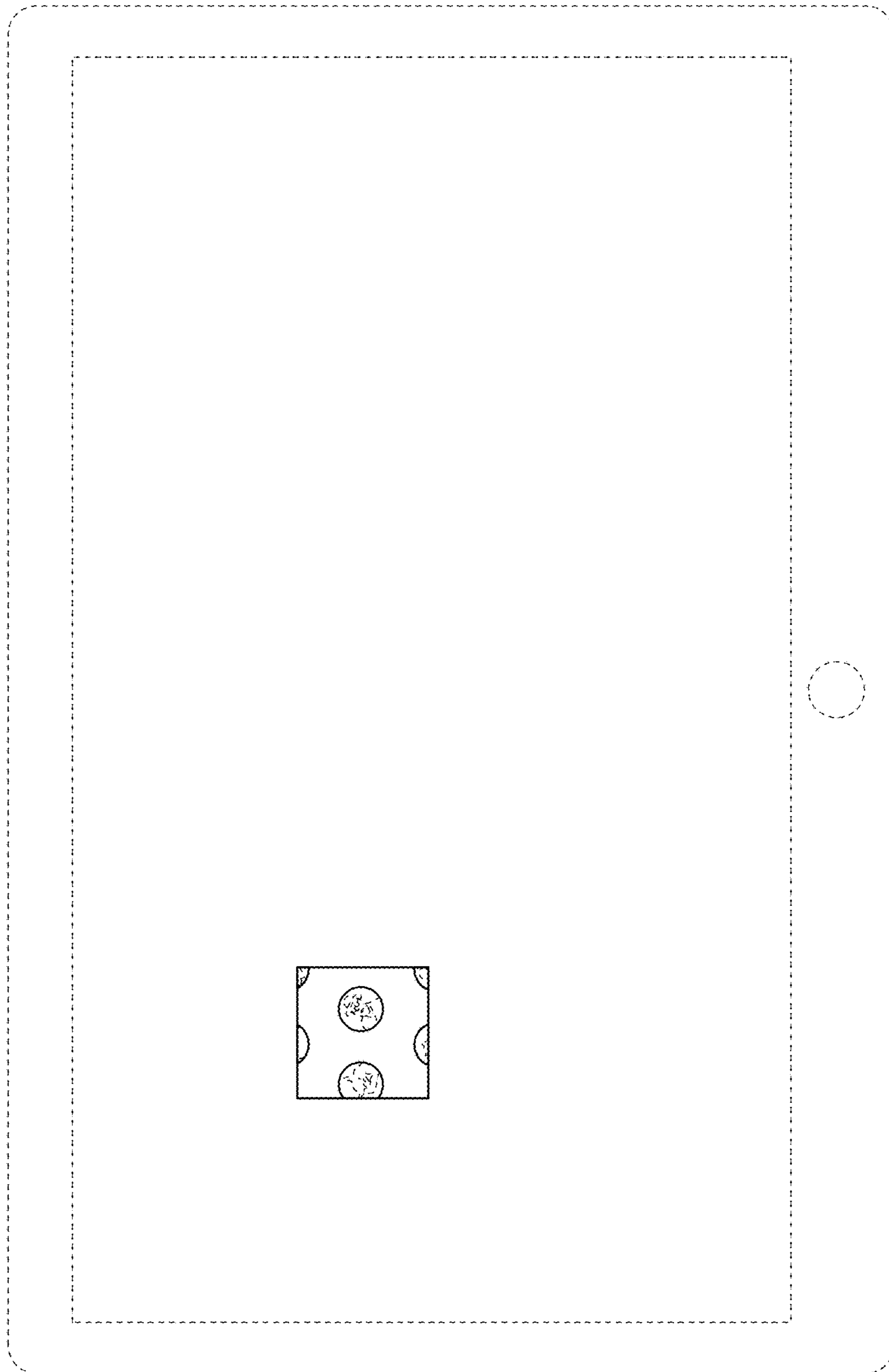

FIG. 9

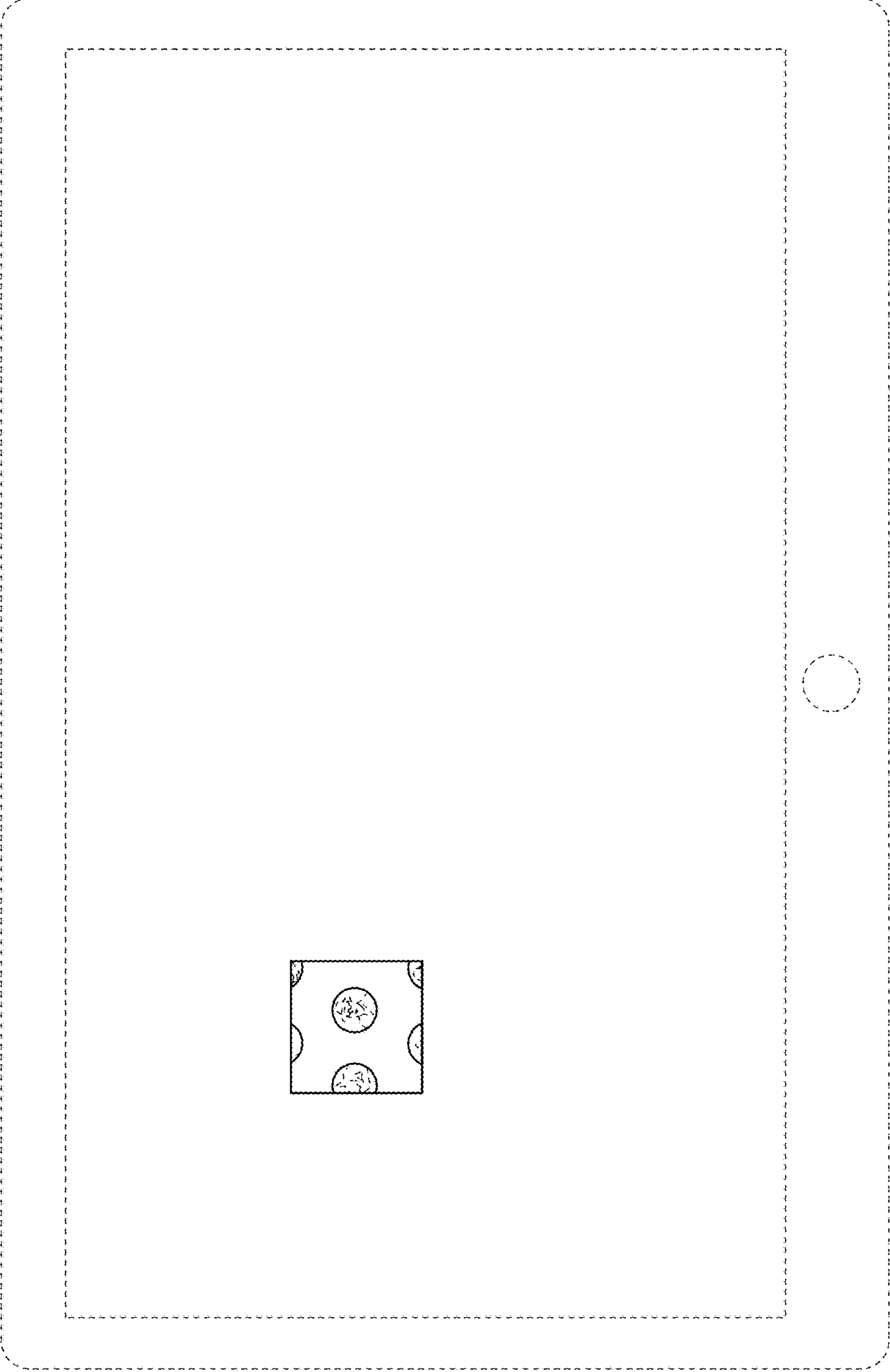

FIG. 10

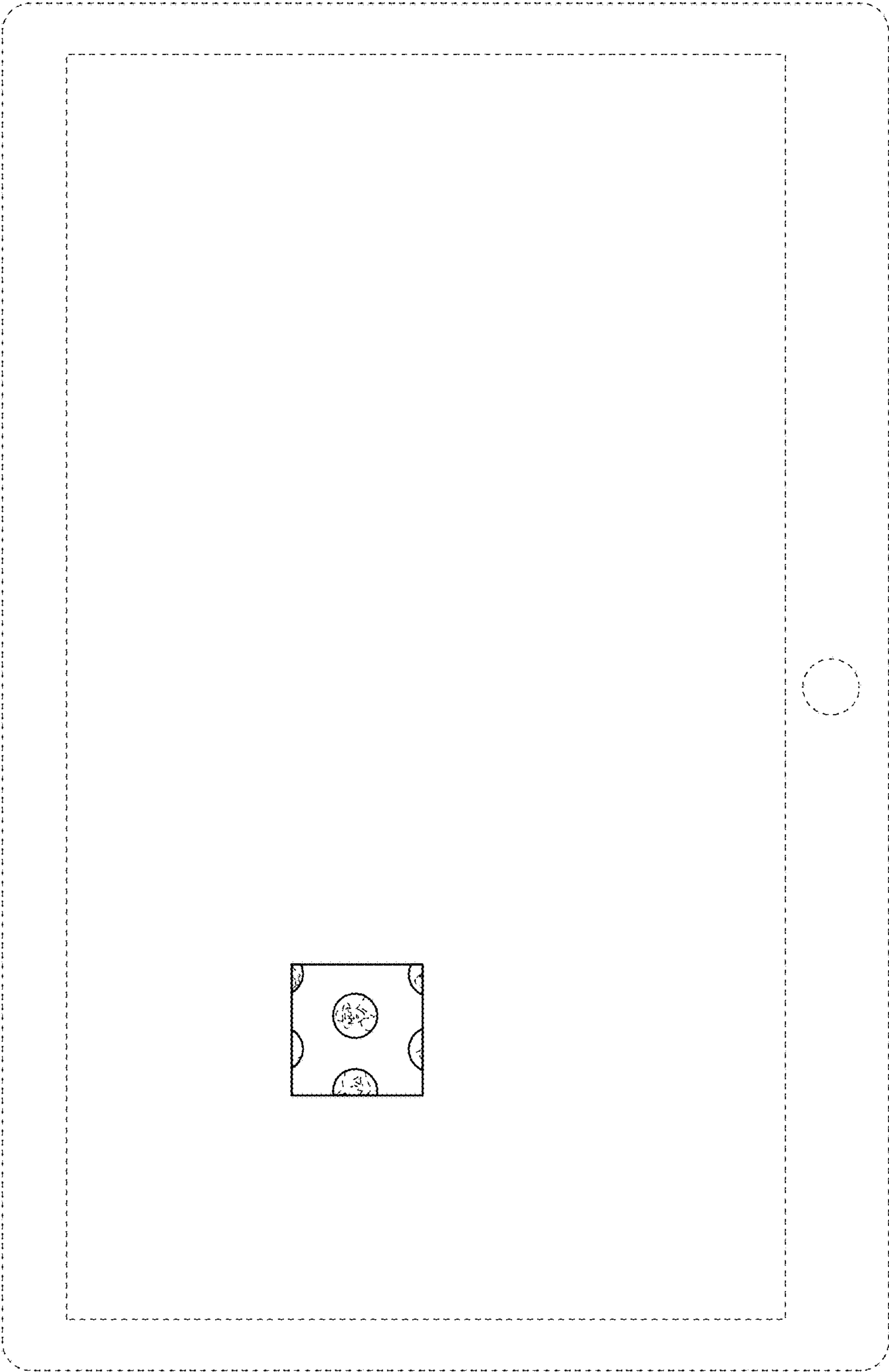

FIG. 11

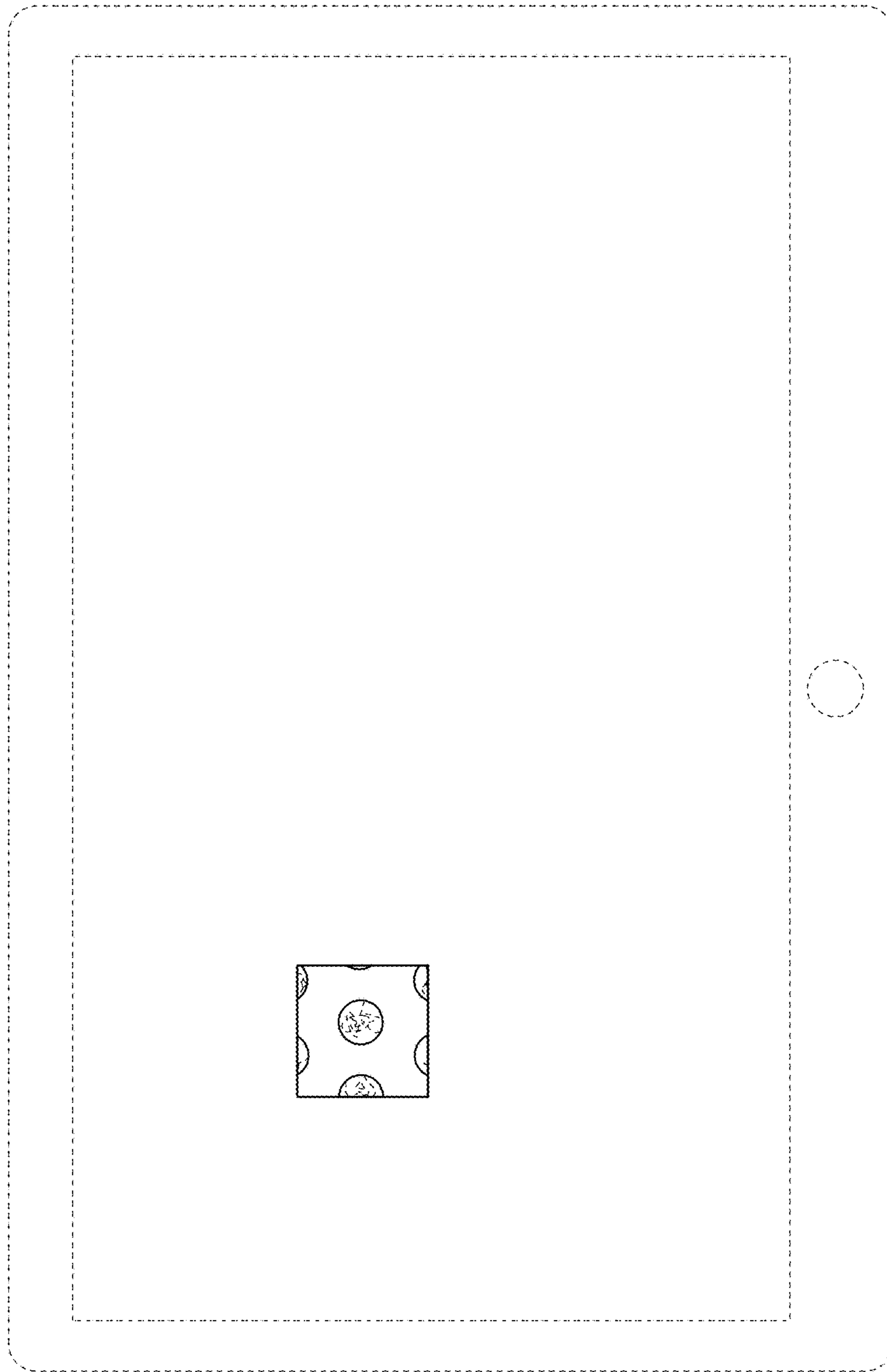

FIG. 12

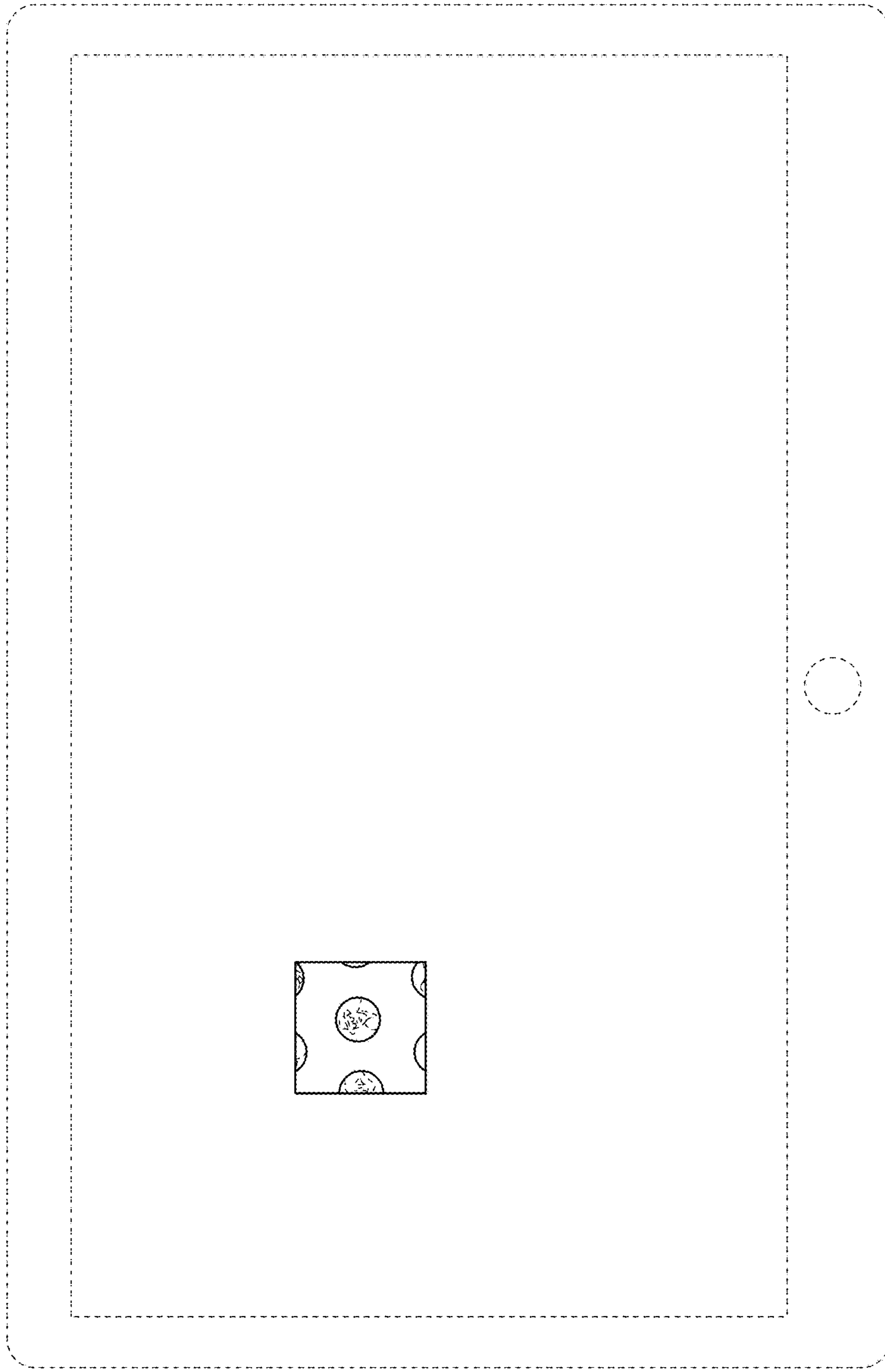

FIG. 13

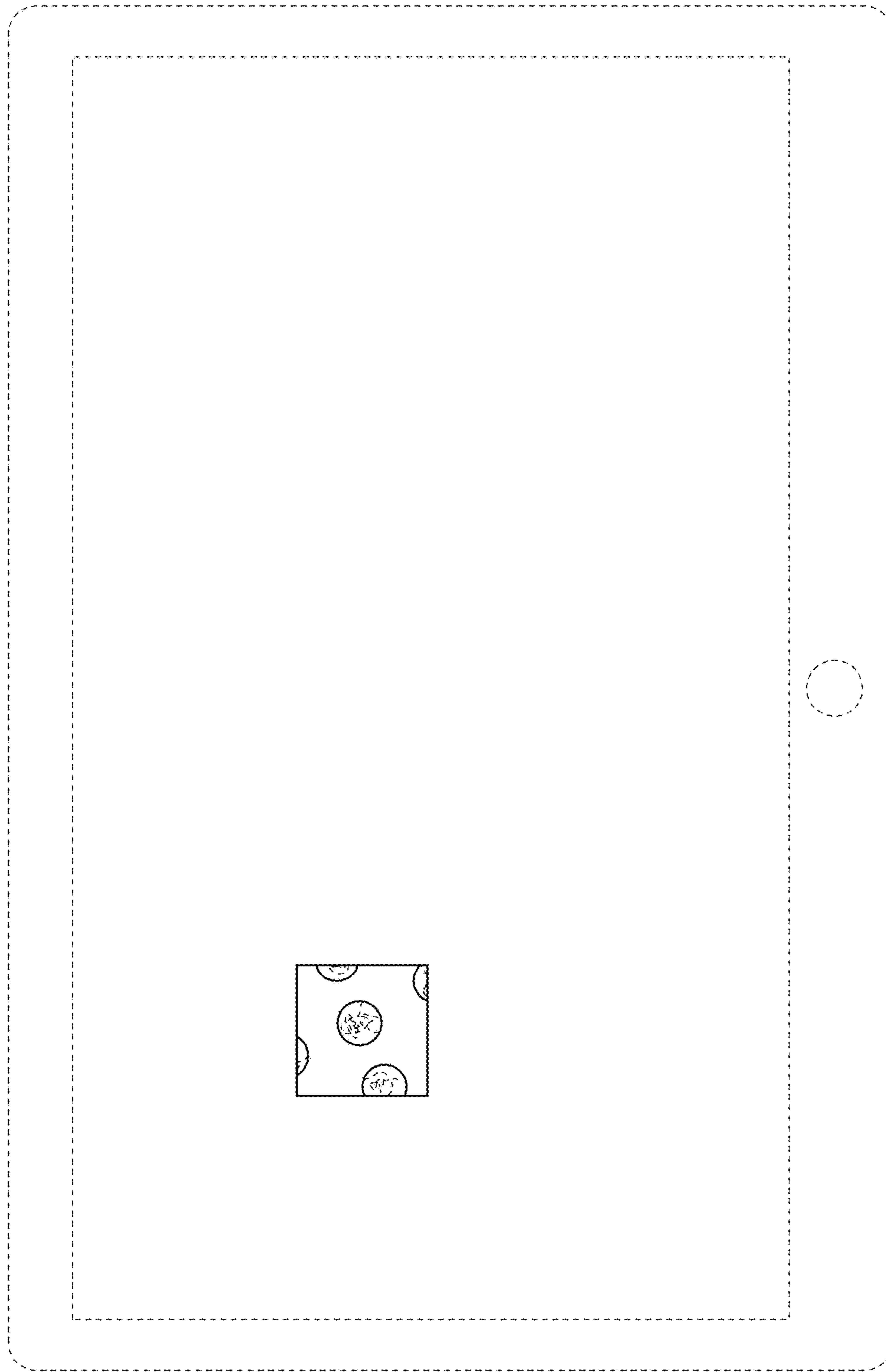

FIG. 14

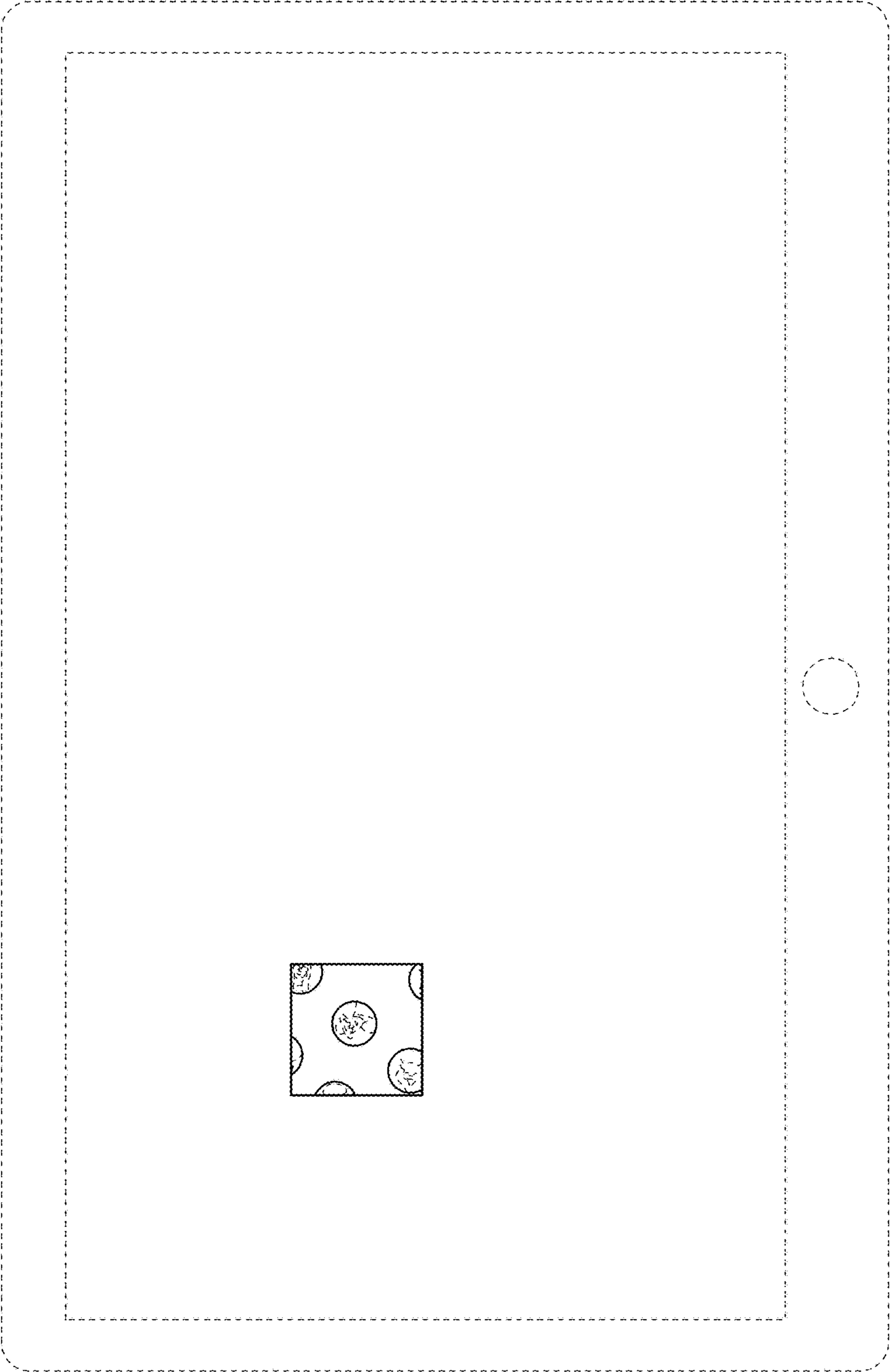

FIG. 15

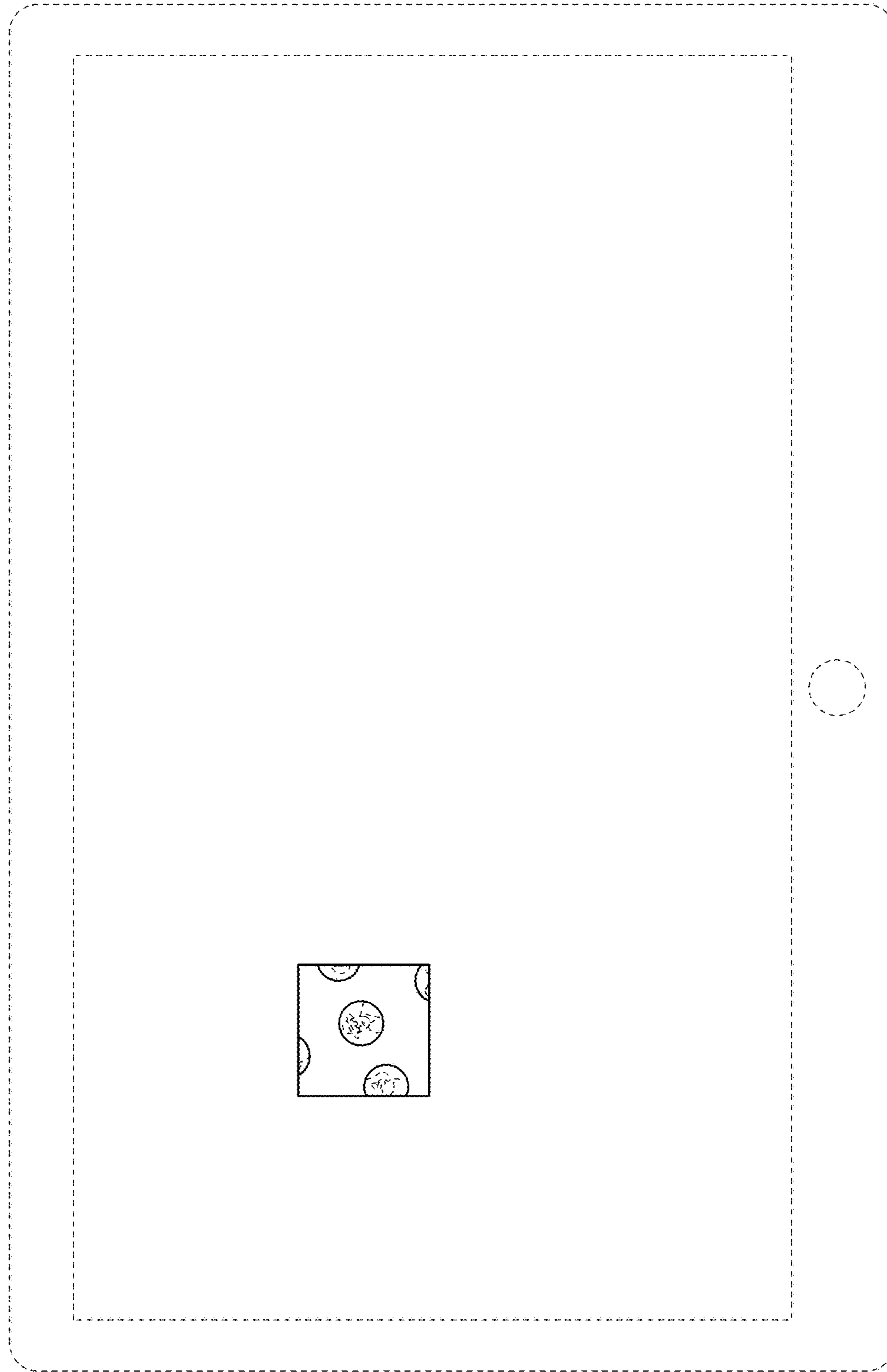

FIG. 16

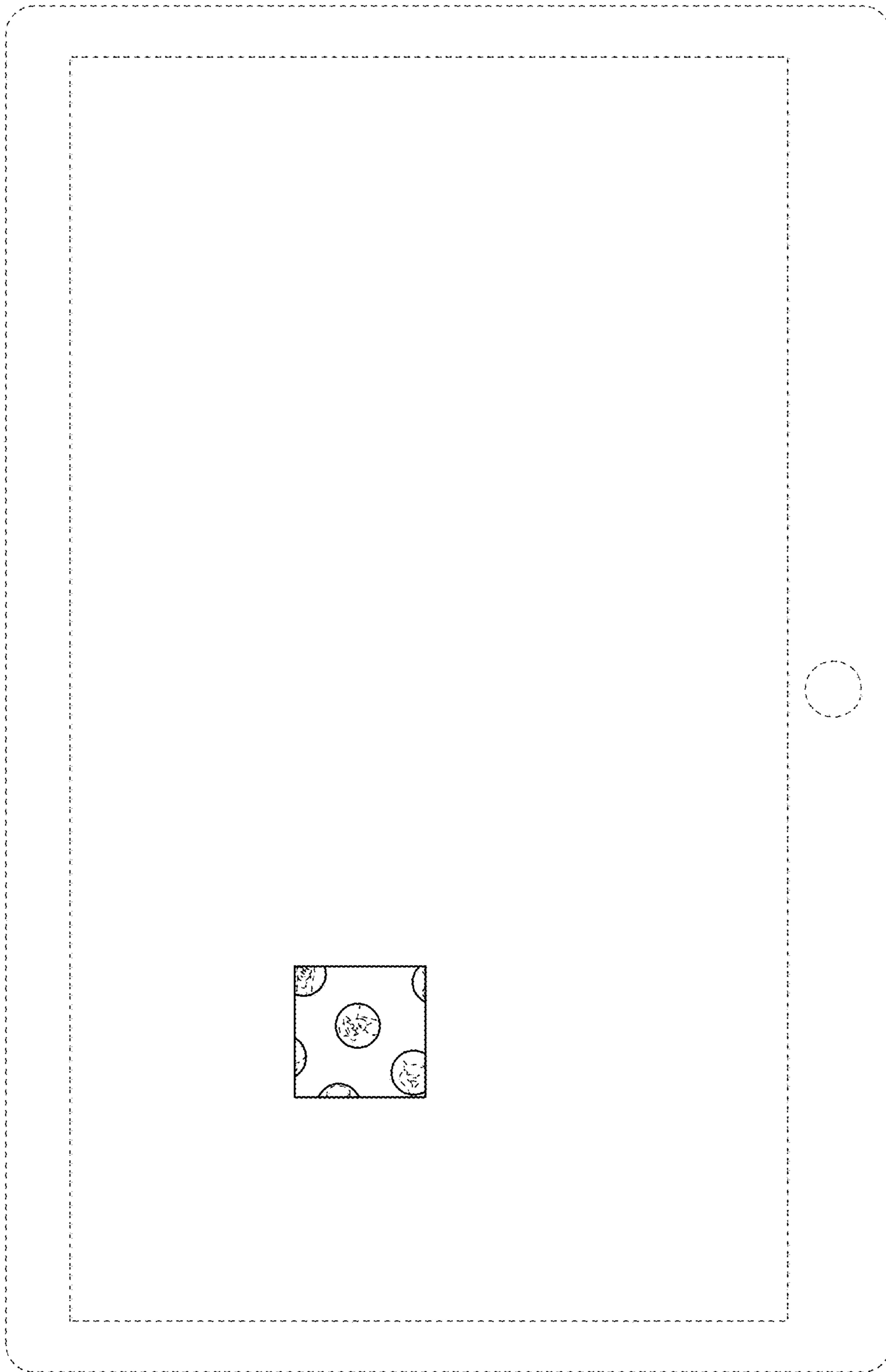

FIG. 17

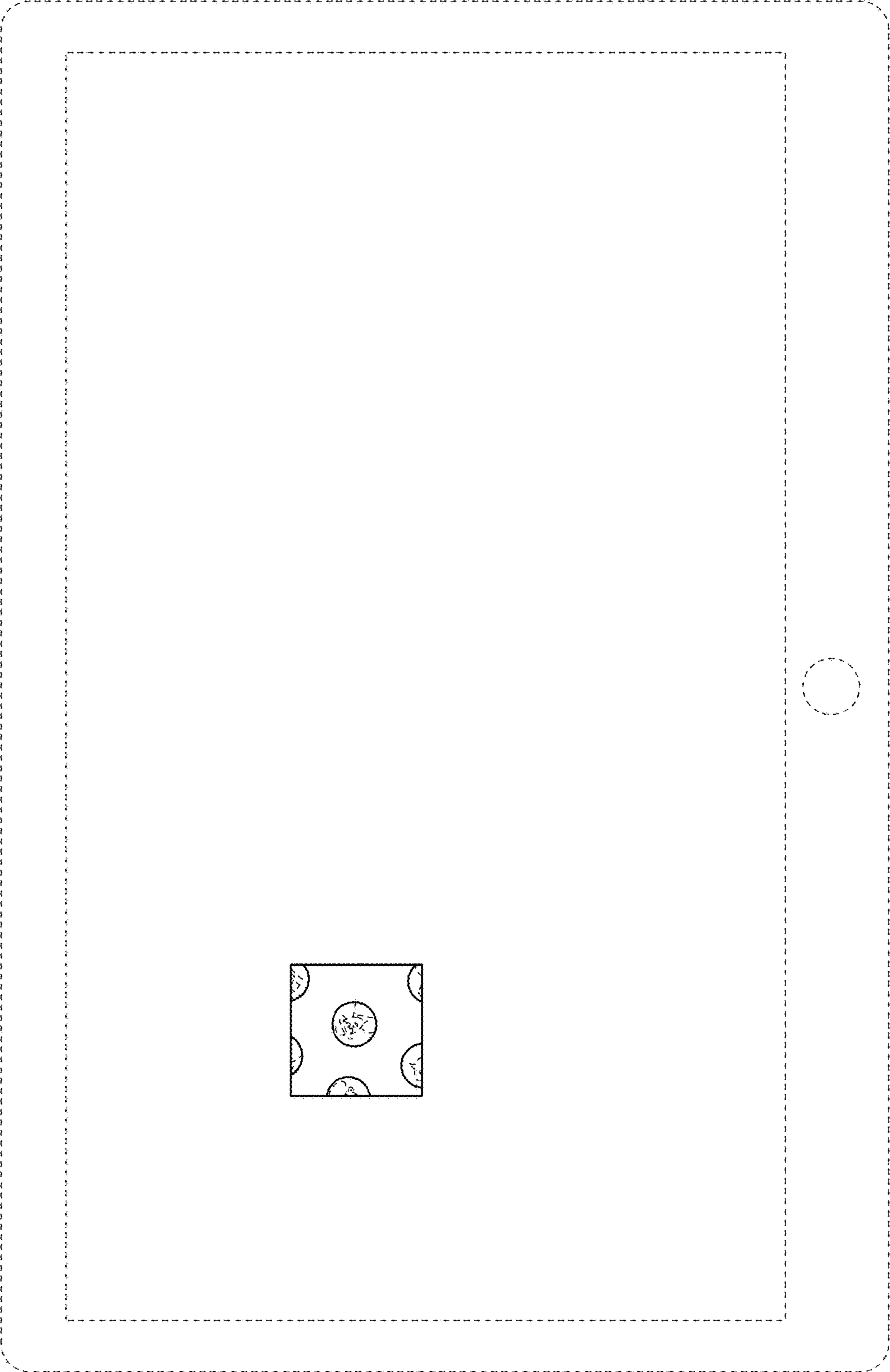

FIG. 18

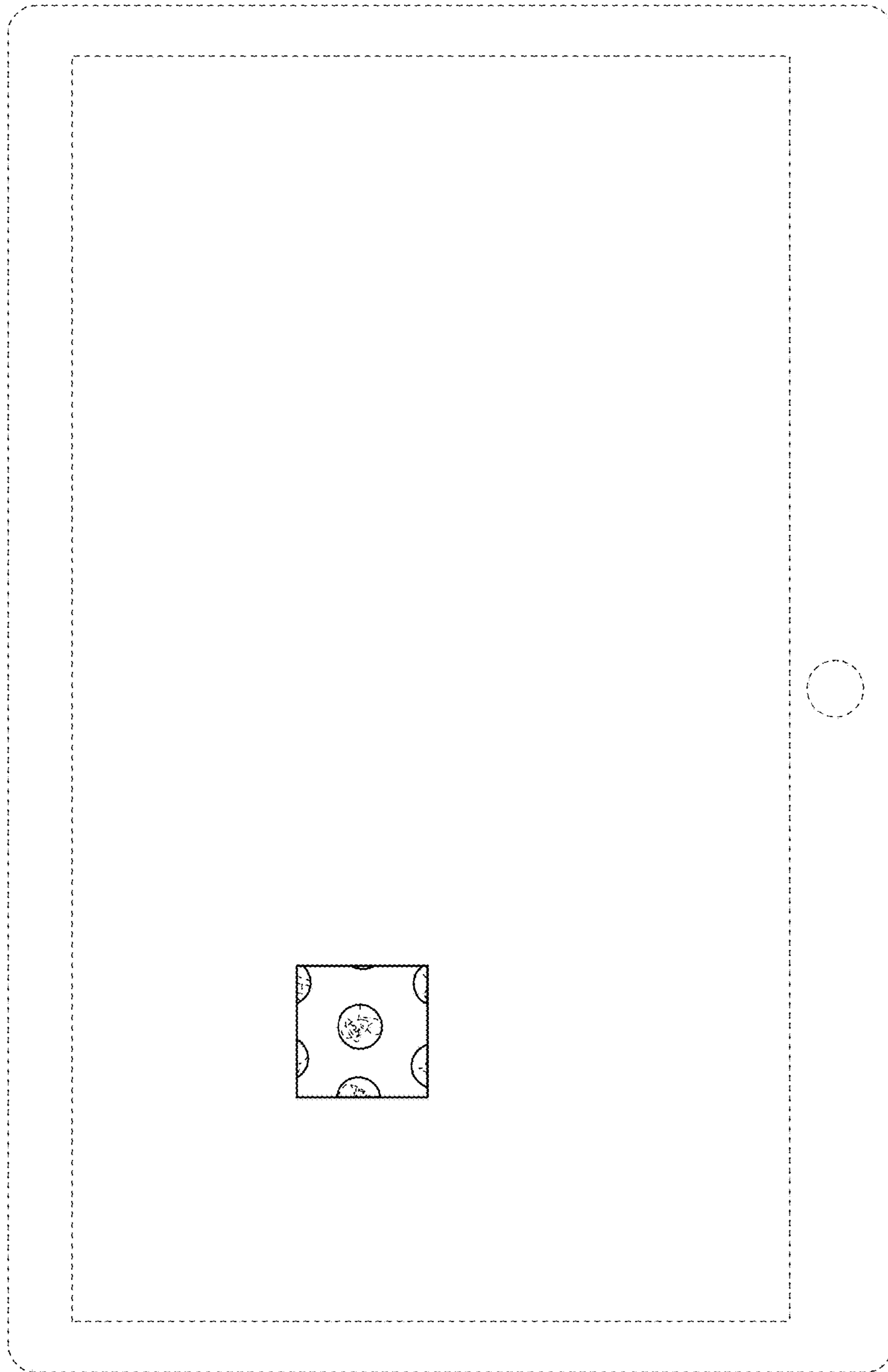

FIG. 19

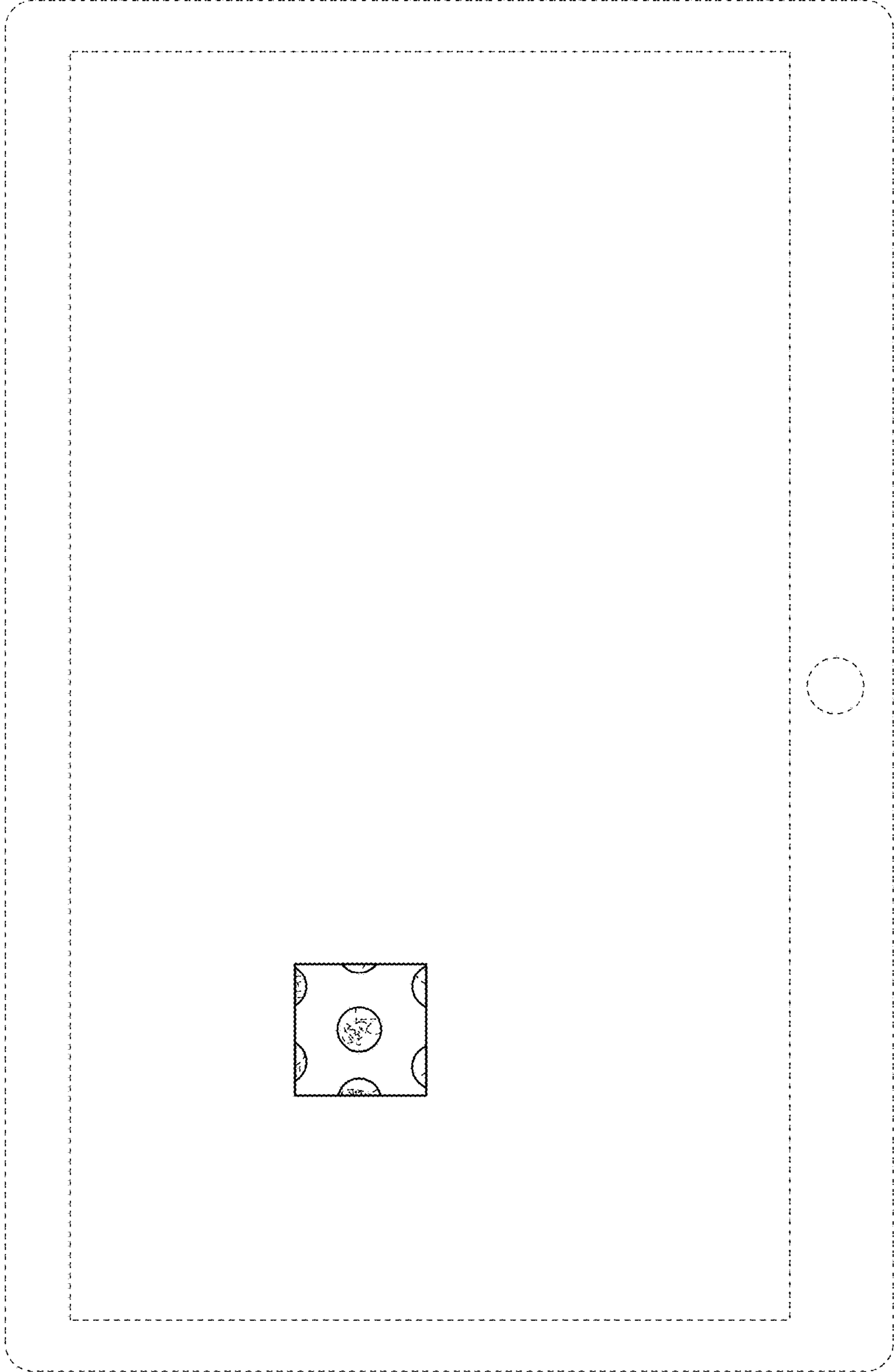

FIG. 20