

US00D776653S

(12) **United States Design Patent** (10) **Patent No.:** **US D776,653 S**
Akana et al. (45) **Date of Patent:** **** *Jan. 17, 2017**

(54) **ELECTRONIC DEVICE**

(71) Applicant: **Apple Inc.**, Cupertino, CA (US)

(72) Inventors: **Jody Akana**, San Francisco, CA (US); **Bartley K. Andre**, Palo Alto, CA (US); **Shota Aoyagi**, San Francisco, CA (US); **Anthony Michael Ashcroft**, San Francisco, CA (US); **Jeremy Bataillou**, San Francisco, CA (US); **Daniel J. Coster**, San Francisco, CA (US); **Daniele De Iuliis**, San Francisco, CA (US); **M. Evans Hankey**, San Francisco, CA (US); **Julian Hoenig**, San Francisco, CA (US); **Richard P. Howarth**, San Francisco, CA (US); **Jonathan P. Ive**, San Francisco, CA (US); **Duncan Robert Kerr**, San Francisco, CA (US); **Matthew Dean Rohrbach**, San Francisco, CA (US); **Peter Russell-Clarke**, San Francisco, CA (US); **Benjamin Andrew Shaffer**, San Jose, CA (US); **Mikael Silvano**, San Francisco, CA (US); **Christopher J. Stringer**, Woodside, CA (US); **Eugene Antony Whang**, San Francisco, CA (US); **Rico Zörkendörfer**, San Francisco, CA (US)

(73) Assignee: **Apple Inc.**, Cupertino, CA (US)

(*) Notice: This patent is subject to a terminal disclaimer.

(**) Term: **14 Years**

(21) Appl. No.: **29/514,931**

(22) Filed: **Jan. 18, 2015**

Related U.S. Application Data

(63) Continuation of application No. 29/513,920, filed on Jan. 6, 2015, now Pat. No. Des. 774,505, which is a continuation of application No. 29/513,921, filed on Jan. 6, 2015.

(51) **LOC (10) Cl.** 14-02

(52) **U.S. Cl.**
USPC **D14/318**

(58) **Field of Classification Search**
USPC . D14/315-327; D18/1, 2, 7, 11; 235/145 A, 235/145 R; 341/22, 23; 345/104, 156, 345/168, 169, 173; 361/679.08, 679.09, 361/679.11, 679.26, 679.27
CPC G06F 1/16; G06F 1/1616; G06F 1/1626; G06F 1/1632; G06F 1/1613; G06F 1/1601; G06F 1/1618; G06F 1/162; G06F 1/166; G06F 1/1654; G06F 1/1681; G06F 1/1637; G06F 1/1688; H01R 35/02; H03M 11/00; G09B 13/04; H03K 17/94; G09G 5/00; F16M 11/10; H05K 5/00; H04M 1/0237

See application file for complete search history.

(56) **References Cited**

U.S. PATENT DOCUMENTS

D264,969 S	6/1982	McGourty
4,976,435 A	12/1990	Shatford et al.
5,192,082 A	3/1993	Inoue et al.
D345,346 S	3/1994	Alfonso et al.
D349,923 S	8/1994	Billings et al.
D359,306 S	6/1995	Lande et al.
D362,272 S	9/1995	Luong
D362,461 S	9/1995	Luong
D378,686 S	4/1997	Proctor et al.
5,661,632 A	8/1997	Register
D385,299 S	10/1997	Adams
D386,521 S	11/1997	Eisenbaum
5,694,292 A	12/1997	Paulsel et al.
5,694,294 A	12/1997	Ohashi et al.
5,713,790 A	2/1998	Lin
D391,927 S	3/1998	Faranda et al.
D396,452 S	7/1998	Naruki
5,793,355 A	8/1998	Youens
D399,526 S	10/1998	Brady
D402,310 S	12/1998	Hendricks
D410,028 S	5/1999	Fyffe
D412,940 S	8/1999	Kato et al.
5,964,661 A	10/1999	Dodge
D416,238 S	11/1999	Irie et al.
6,038,128 A	3/2000	Hood et al.
D425,558 S	5/2000	Tarpenning et al.
D425,874 S	5/2000	Tanimura

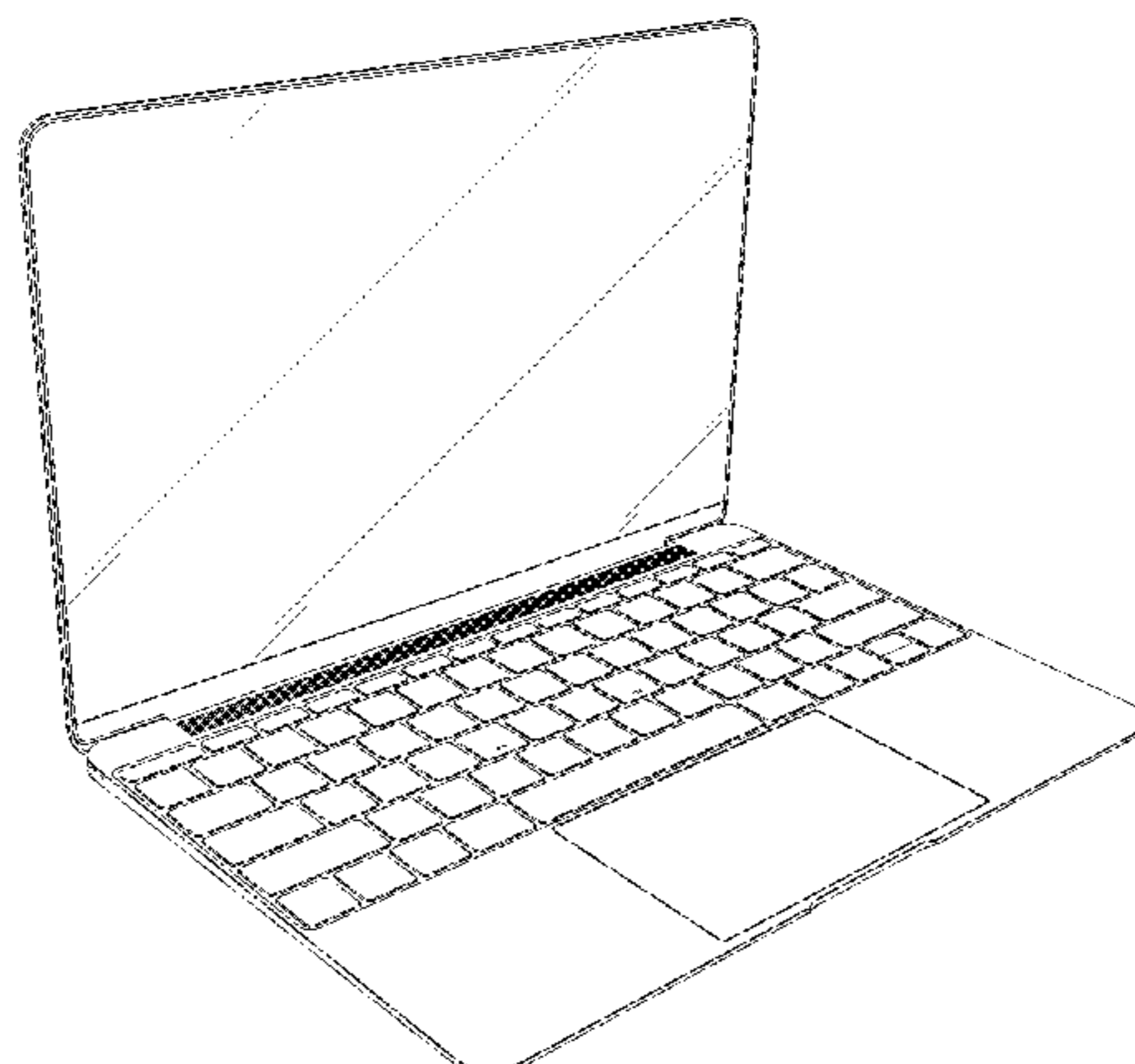

(56)

References Cited

U.S. PATENT DOCUMENTS

6,067,224 A	5/2000	Nobuchi	7,660,104 B2	2/2010	Ligtenberg
D430,117 S	8/2000	Sachs et al.	D611,043 S	3/2010	Andre et al.
D430,169 S	8/2000	Scibora	D611,044 S	3/2010	Andre et al.
D431,821 S	10/2000	Mizuno	D611,045 S	3/2010	Andre et al.
6,166,737 A	12/2000	Lee et al.	D611,469 S	3/2010	Andre et al.
D437,860 S	2/2001	Suzuki et al.	D612,843 S	3/2010	Andre et al.
D445,787 S	7/2001	Francis	D613,284 S	4/2010	Solomon et al.
6,254,477 B1	7/2001	Sasaki et al.	D616,880 S	6/2010	Andre et al.
D448,810 S	10/2001	Goto	D616,881 S	6/2010	Andre et al.
D449,606 S	10/2001	Lee et al.	D617,789 S	6/2010	Akana et al.
D450,713 S	11/2001	Masamitsu et al.	7,733,636 B2	6/2010	Kobayashi et al.
D451,505 S	12/2001	Iseki et al.	D621,409 S	8/2010	Andre et al.
D452,250 S	12/2001	Chan	D621,825 S	8/2010	Andre et al.
D453,333 S	2/2002	Chen	D622,268 S	8/2010	Hong et al.
D458,252 S	6/2002	Palm et al.	D623,645 S	9/2010	Andre et al.
D463,797 S	10/2002	Andre et al.	D624,911 S *	10/2010	Lee D14/315
D469,109 S	1/2003	Andre et al.	D625,716 S	10/2010	Andre et al.
D472,245 S	3/2003	Andre et al.	D625,717 S	10/2010	Andre et al.
D481,036 S	10/2003	Wentt	D633,087 S	2/2011	Andre et al.
6,657,854 B2	12/2003	Horii et al.	D633,488 S	3/2011	Kim et al.
D486,823 S	2/2004	Kuo	D633,907 S	3/2011	Andre et al.
D487,457 S	3/2004	Liu	D635,566 S	4/2011	Andre et al.
D487,742 S	3/2004	Huang et al.	7,948,752 B2	5/2011	Tatsukami et al.
D489,717 S	5/2004	Hsieh	D639,295 S	6/2011	Andre et al.
D490,420 S	5/2004	Solomon et al.	D642,172 S	7/2011	Akana et al.
D491,177 S *	6/2004	Andre D14/318	D642,560 S	8/2011	Akana et al.
D491,933 S	6/2004	Guo	D648,333 S	11/2011	Andre et al.
D491,936 S	6/2004	Jao	D648,334 S	11/2011	Andre et al.
6,744,623 B2	6/2004	Numano et al.	D652,032 S	1/2012	Akana et al.
D493,785 S	8/2004	Andre et al.	D654,072 S	2/2012	Andre et al.
D494,164 S	8/2004	Wu et al.	D655,704 S	3/2012	Akana et al.
6,771,494 B2	8/2004	Shimano	8,139,352 B2	3/2012	Yamamoto et al.
D497,618 S	10/2004	Andre et al.	D657,786 S	4/2012	Andre et al.
D501,472 S	2/2005	Kumano	D661,296 S	6/2012	Akana et al.
D501,660 S	2/2005	Kumano	D662,497 S	6/2012	Akana et al.
6,876,546 B2	4/2005	Tsao	D664,537 S	7/2012	Hu et al.
D504,889 S	5/2005	Andre et al.	8,223,487 B2	7/2012	Chen et al.
6,932,525 B2	8/2005	Trotman	8,238,090 B2	8/2012	Watanabe
D512,997 S	12/2005	Lee et al.	8,339,775 B2	12/2012	Degner et al.
6,972,946 B2	12/2005	Hamada et al.	D674,382 S	1/2013	Andre et al.
D513,509 S	1/2006	Kawa	D674,399 S *	1/2013	Welch D14/455
D517,063 S	3/2006	Nakajima et al.	D676,042 S *	2/2013	McManigal D14/318
7,012,802 B2	3/2006	Nakajima et al.	D676,437 S	2/2013	Akana et al.
7,035,665 B2	4/2006	Kido et al.	D676,438 S	2/2013	Akana et al.
D523,429 S	6/2006	Lin	D679,704 S	4/2013	McManigal et al.
D524,306 S	7/2006	Yun et al.	D679,705 S *	4/2013	McManigal D14/318
D526,999 S	8/2006	Tago	D682,821 S	5/2013	Kim
D527,730 S	9/2006	Dong	D685,784 S	7/2013	Ma
D529,907 S	10/2006	Dong	D686,205 S	7/2013	Akana et al.
D533,550 S	12/2006	Yamada	D687,030 S	7/2013	Andre et al.
D547,310 S	7/2007	Yoon	D687,031 S	7/2013	Chen et al.
D556,192 S	11/2007	Jeong et al.	D691,128 S	10/2013	Akana et al.
D558,752 S	1/2008	Andre et al.	D691,129 S	10/2013	Akana et al.
D558,753 S	1/2008	Andre et al.	D694,748 S	12/2013	Okuley et al.
D571,364 S	6/2008	Andre et al.	D696,244 S	12/2013	Akana et al.
D572,246 S	7/2008	Andre et al.	D696,569 S	12/2013	Luo
D572,247 S	7/2008	Andre et al.	D696,660 S	12/2013	Chen et al.
D574,378 S	8/2008	Andre et al.	D696,661 S	12/2013	Chen et al.
7,426,113 B2	9/2008	Ikeno et al.	8,687,359 B2	4/2014	Thobald et al.
D581,411 S	11/2008	Kumano	8,734,036 B2	5/2014	Hirsch
D589,507 S	3/2009	Andre et al.	D706,759 S	6/2014	Myung et al.
D600,688 S	9/2009	Andre et al.	D706,772 S	6/2014	Koyama et al.
D601,556 S	10/2009	Iseki	D708,176 S	7/2014	Akana et al.
D603,861 S	11/2009	Hong et al.	D708,179 S	7/2014	Andre et al.
D604,289 S	11/2009	Andre et al.	D717,787 S	11/2014	Jung et al.
D604,290 S	11/2009	Andre et al.	D719,149 S *	12/2014	Matsuoka D14/318
D604,291 S	11/2009	Andre et al.	8,947,874 B2	2/2015	Andre et al.
D604,292 S	11/2009	Andre et al.	D723,539 S	3/2015	Andre et al.
D604,293 S	11/2009	Andre et al.	D729,227 S	5/2015	Fukuoka
D604,294 S	11/2009	Andre et al.	D741,316 S	10/2015	Andre et al.
D606,068 S	12/2009	Hong et al.	2005/0008418 A1	1/2005	Green
D606,534 S *	12/2009	Hong D14/315	2005/0180794 A1	8/2005	Parkinson
D606,988 S	12/2009	Andre et al.	2005/0207817 A1	9/2005	Jenkins
D606,989 S	12/2009	Andre et al.	2006/0147239 A1	7/2006	Kuriss
D607,450 S	1/2010	Morishita et al.	2006/0257191 A1	11/2006	Artus
			2008/0074833 A1	3/2008	Chien et al.
			2010/0067182 A1	3/2010	Tanaka et al.
			2011/0242750 A1 *	10/2011	Oakley G06F 1/1637 361/679.27

(56)

References Cited

U.S. PATENT DOCUMENTS

2011/0255727 A1* 10/2011 Azuchi G06F 1/1616
381/333
2011/0267757 A1* 11/2011 Probst G06F 1/1616
361/679.09
2012/0099263 A1 4/2012 Lin

FOREIGN PATENT DOCUMENTS

CN	301384975	11/2010
JP	1128620	12/2001
JP	1438161	4/2012
JP	1469539	5/2013
KR	30-0608518-0000	8/2011
KR	30-0613298-0000	9/2011
KR	30-0687340-0000	4/2013

OTHER PUBLICATIONS

Sony X505, available at least as early as May 8, 2005.
HP Compaq Tablet PC Tc 1100, http://web.archive.org/web/20040726084509/h_18000.www1.hp.com/products/tabletpc/, downloaded Aug. 27, 2004.
Tablet PC V1100, <http://web.archive.org/web/20040714060448/www.viewsonic.com/products/desktopdisplays/tabletpc/tabletpcv1100/>, downloaded Aug. 27, 2004.
VIA Tablet PC Reference Design: The Digital Notepad, <http://www.via.com/en/initiatives/spearhead/information-pc/>, downloaded Aug. 27, 2004.
ViewPad 1000, http://www.viewsonic.com/support/mobilewireless/tabletpc/viewpad1000_index.htm, downloaded Aug. 27, 2004.
Photographs of Sony VAIO PCG-4G1L, available at least as early as May 8, 2006.
Apple PowerBook G4 Titanium, available at least as early as Jan. 1, 2001.
Apple PowerBook G4 Aluminum, available at least as early as Jan. 1, 2003.
Apple MacBook Pro, available at least as early as Jan. 10, 2006.
Apple MacBook Air, available Jan. 15, 2008, http://images.apple.com/macbookair/images/design_gal01_20080115.jpg.
Apple MacBook Air, available Jan. 15, 2008, http://images.apple.com/macbookair/images/design_gal02_20080115.jpg.
Apple MacBook Air, available Jan. 15, 2008, http://images.apple.com/macbookair/images/design_gal03_20080115.jpg.
Apple MacBook Air, available Jan. 15, 2008, http://images.apple.com/macbookair/images/design_gal04_20080115.jpg.
Apple MacBook Air, available Jan. 15, 2008, http://images.apple.com/macbookair/images/design_thinair20080115.
Apple MacBook Air, available Jan. 15, 2008, http://images.apple.com/macbookair/images/design_displayair20080115.jpg.
Apple MacBook Air, available Jan. 15, 2008, http://images.apple.com/macbookair/images/design_keyboardair20080115.jpg.
Apple MacBook Air, available Jan. 15, 2008, http://images.apple.com/macbookair/images/design_gal08_20080115.jpg.
Appendix in U.S. Appl. No. 29/201,636, entitled "Electronic Device" filed Mar. 17, 2004, now U.S. Pat. No. D. 504,889.
Olidata Altro, available at least as early as Jun. 1, 2009.
Olidata Altro, <http://notebookitalia.it/olidata-altro-italian-style-notebook-culv-5674.html>, published Mar. 3, 2009.
Rudi, 13-inch MacBook Air has a modern interior, Nov. 2, 2011, prohardver, 2pgs.

U.S. Appl. No. 29/513,920 to Jody Akana et al., titled "Electronic Device", filed Jan. 6, 2015 (unpublished).
U.S. Appl. No. 29/513,921 to Jody Akana et al., titled "Electronic Device", filed Jan. 6, 2015 (unpublished).
Sharp Corporation, Sharp Releases Notebook PC with Optical Sensor LCD Pad, "Mebius", <http://www.sharp.co.jp/corporate/news/090421-a.html>, available as early as Apr. 21, 2009.
Designboom, Lenovo Yoga 3 Pro Laptop's Flexible-Use Stabilized by Watchband Hinge, <http://www.designboom.com/technology/lenovo-yoga-3-pro-laptop-10-10-2014/>, available as early as Oct. 10, 2014.
Mark Gurman, Apple's next major Mac revealed: the radically new 12-inch MacBook Air, <https://9to5mac.com/2015/01/06/macbook-air-12-inch-redesign/>, available as early as Jan. 6, 2015.
Best Buy Co., Inc., <http://www.bestbuy.com/site/olspage.jsp?id=cat13506&type=page&skuId=9441909&productId=1218105184065&navigation=next&count=1&chk=true&h=387>, available as early as Sep. 4, 2009.
17-inch Apple MacBook Pro Review, http://www.laptopmag.com/uploadedimages/review/laptops/2009/apple/macbook_pro_2561g.jpg, available as early as Feb. 25, 2009.

* cited by examiner

Primary Examiner — Freda S Nunn
(74) *Attorney, Agent, or Firm* — Saidman DesignLaw Group, LLC

(57)

CLAIM

The ornamental design for an electronic device, as shown and described.

DESCRIPTION

FIG. 1 is a closed top front perspective view of an electronic device showing our new design;
FIG. 2 is a closed bottom front perspective view thereof;
FIG. 3 is a closed top rear perspective view thereof;
FIG. 4 is a closed bottom rear perspective view thereof;
FIG. 5 is a closed front view thereof;
FIG. 6 is a closed rear view thereof;
FIG. 7 is a closed left side view thereof;
FIG. 8 is a closed right side view thereof;
FIG. 9 is a closed top view thereof;
FIG. 10 is a closed bottom view thereof;
FIG. 11 is an open top front perspective view thereof;
FIG. 12 is an open top rear perspective view thereof;
FIG. 13 is an open bottom front perspective view thereof;
FIG. 14 is an open bottom rear perspective view thereof;
FIG. 15 is an open front view thereof;
FIG. 16 is an open rear view thereof;
FIG. 17 is an open left side view thereof;
FIG. 18 is an open right side view thereof;
FIG. 19 is an open top view thereof; and,
FIG. 20 is an open bottom view thereof.
The dashed broken lines represent structure or features that form no part of the claimed design.
The oblique shade lines represent a transparent surface.

1 Claim, 18 Drawing Sheets

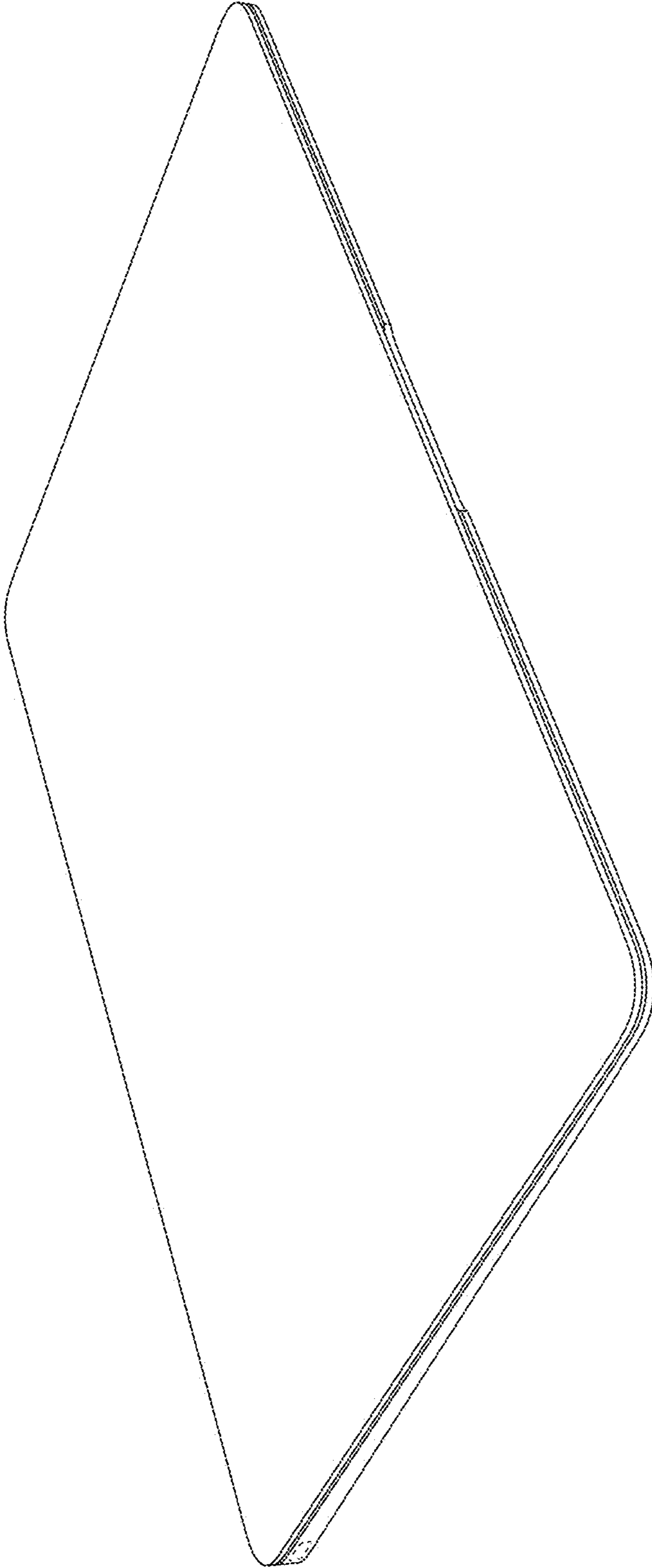

Fig. 1

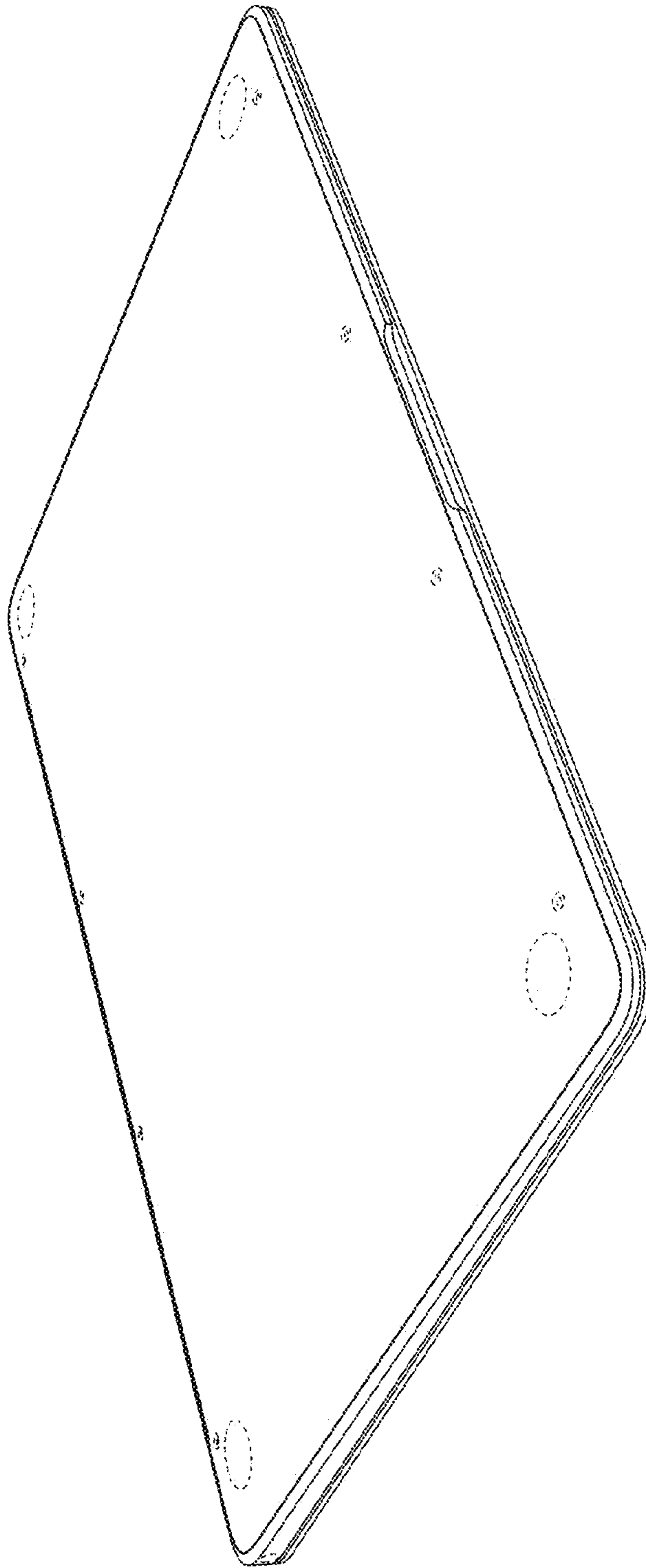

Fig. 2

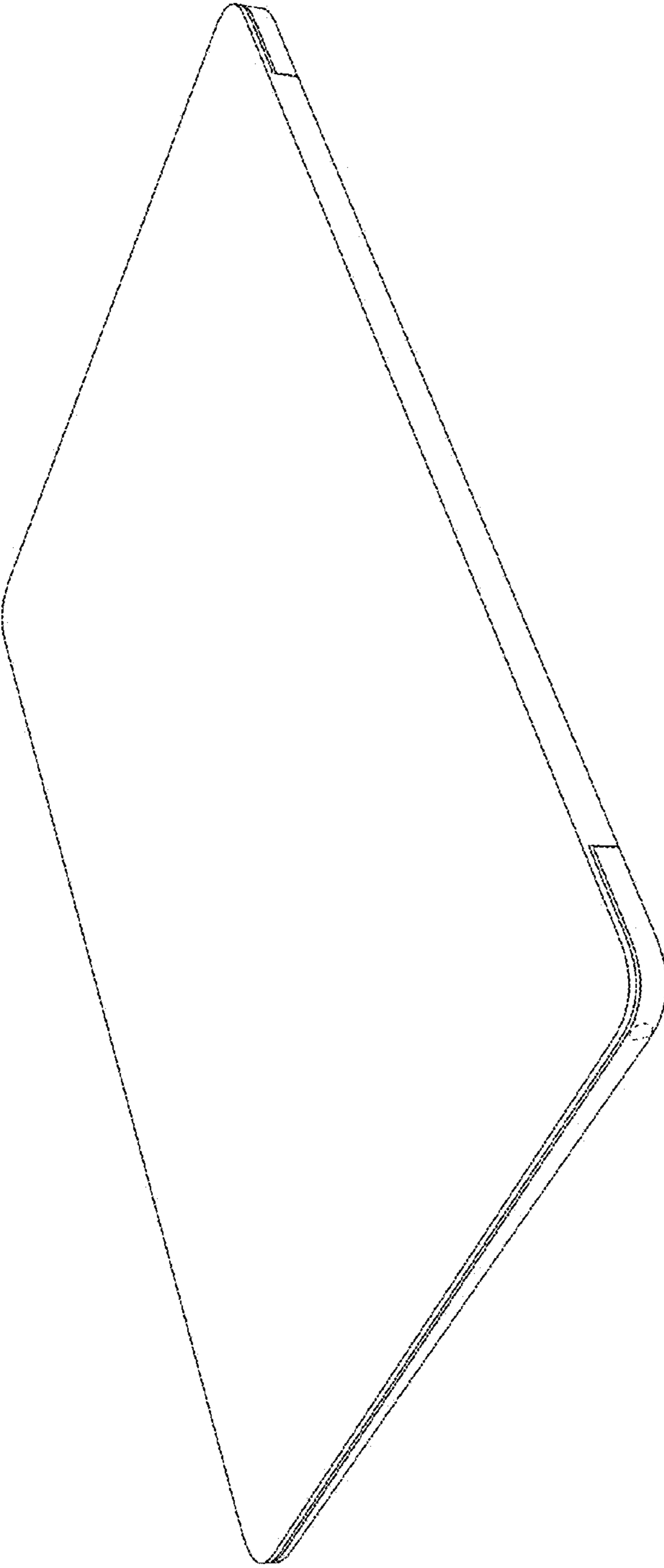

Fig. 3

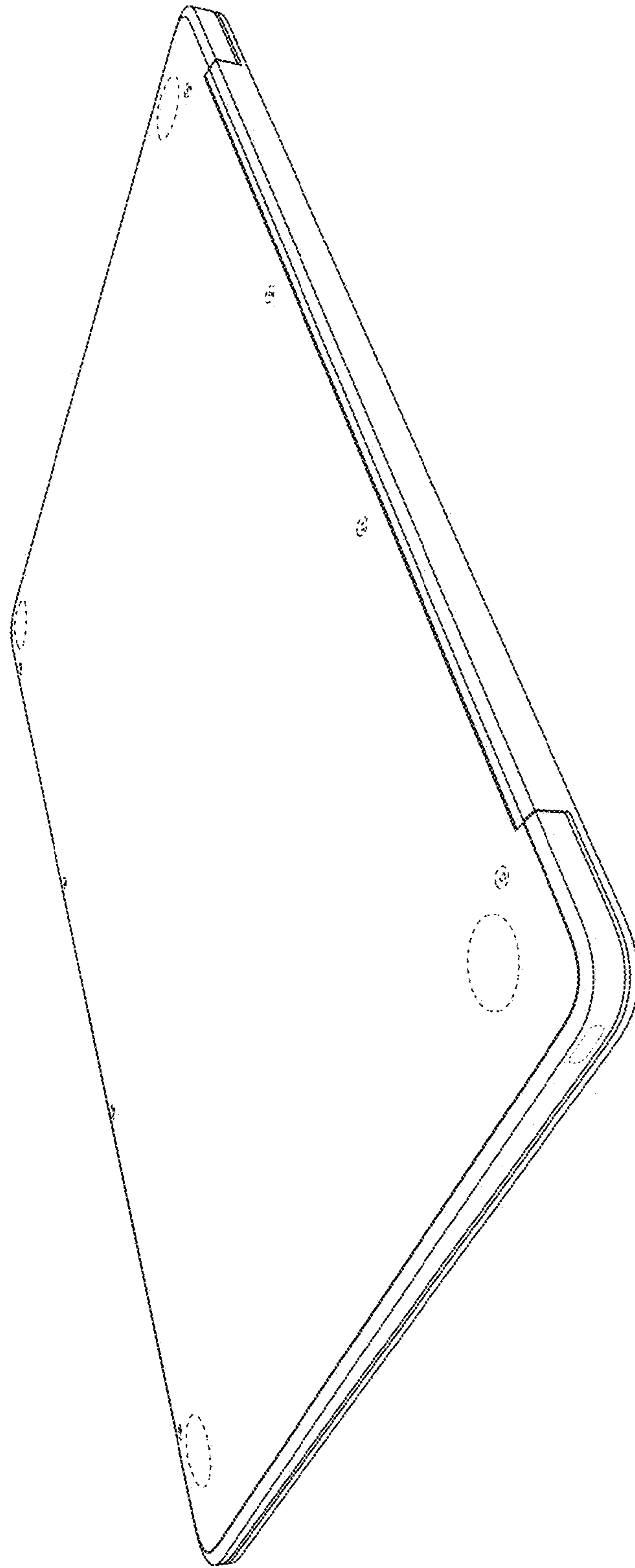

Fig. 4

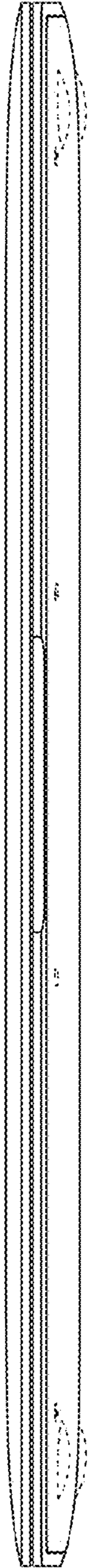

Fig. 5

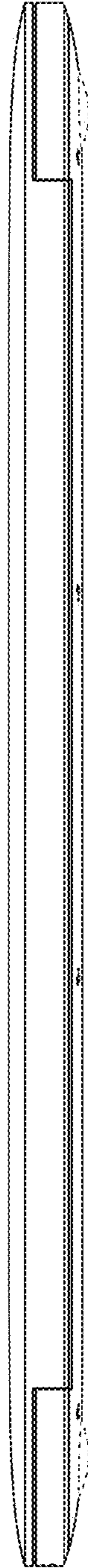

Fig. 6

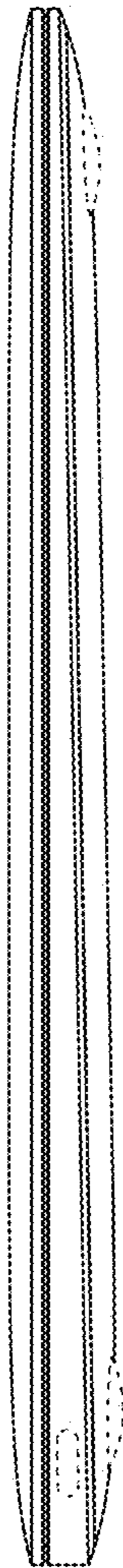

Fig. 7

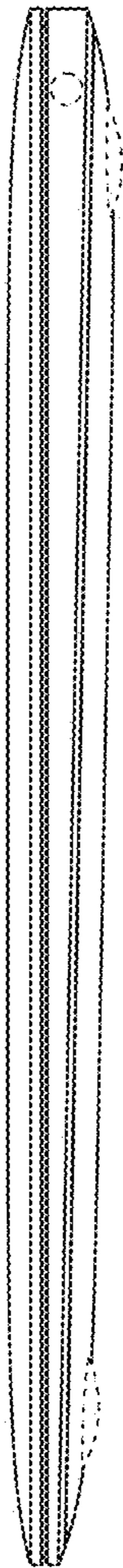

Fig. 8

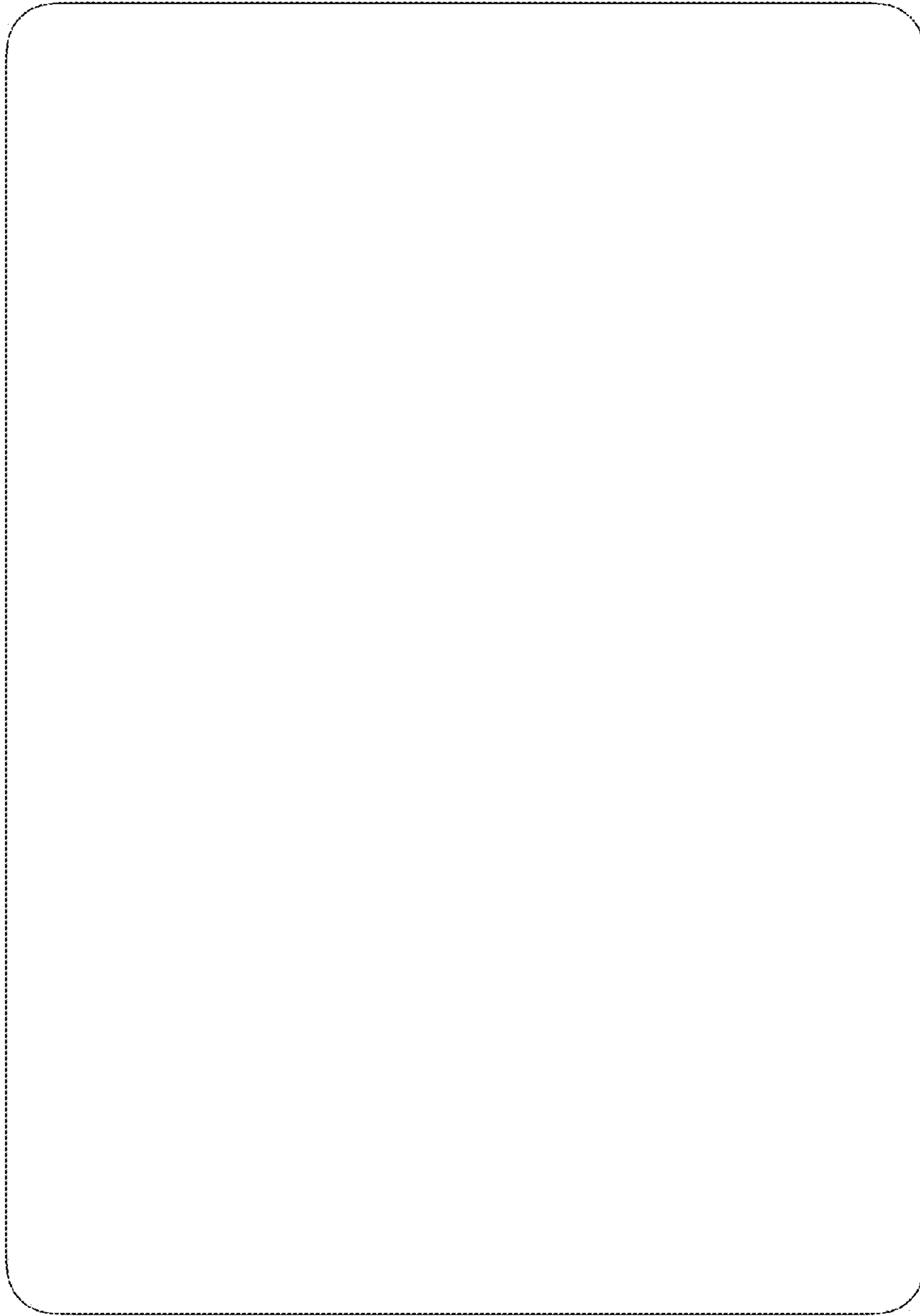

Fig. 9

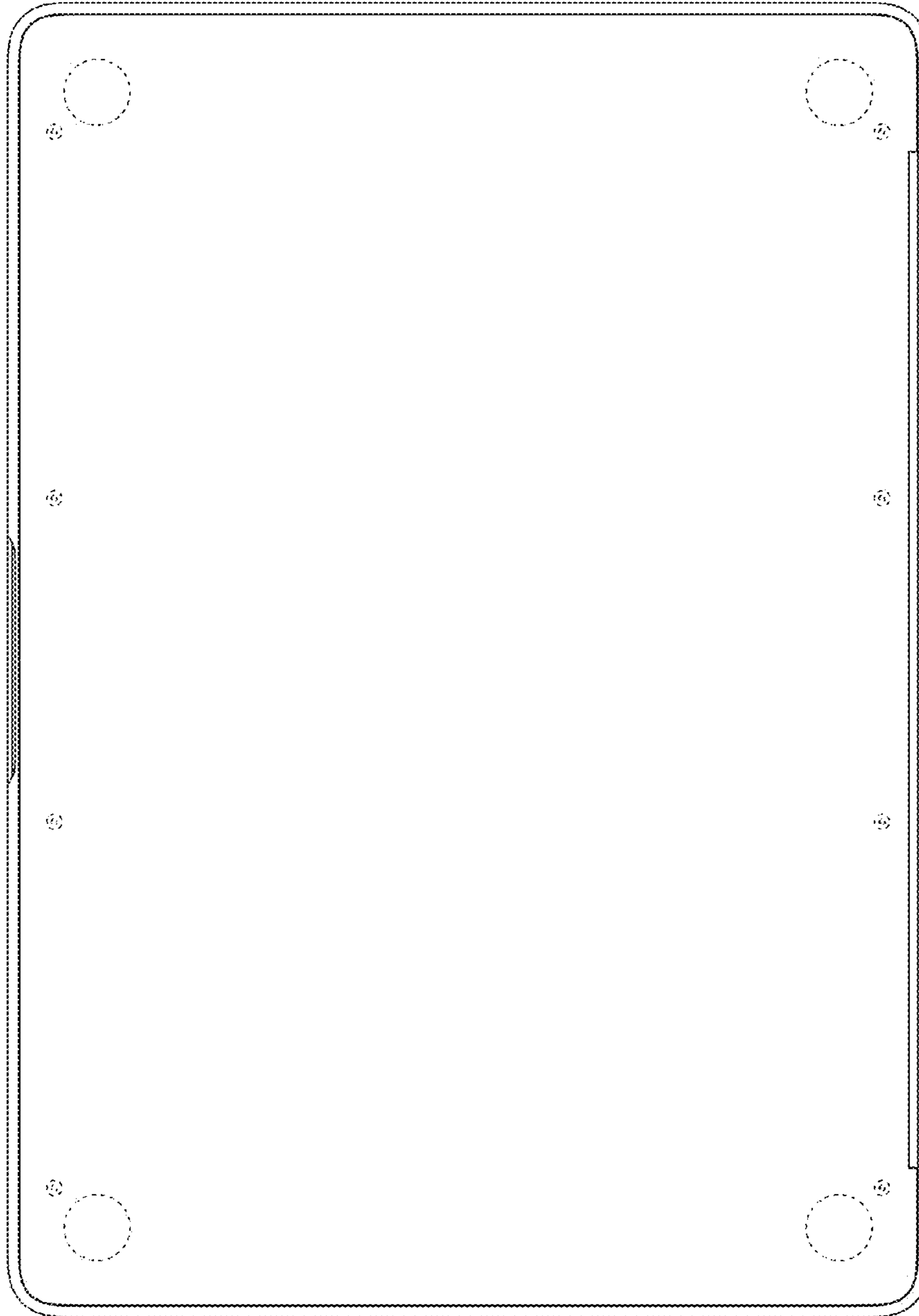

Fig. 10

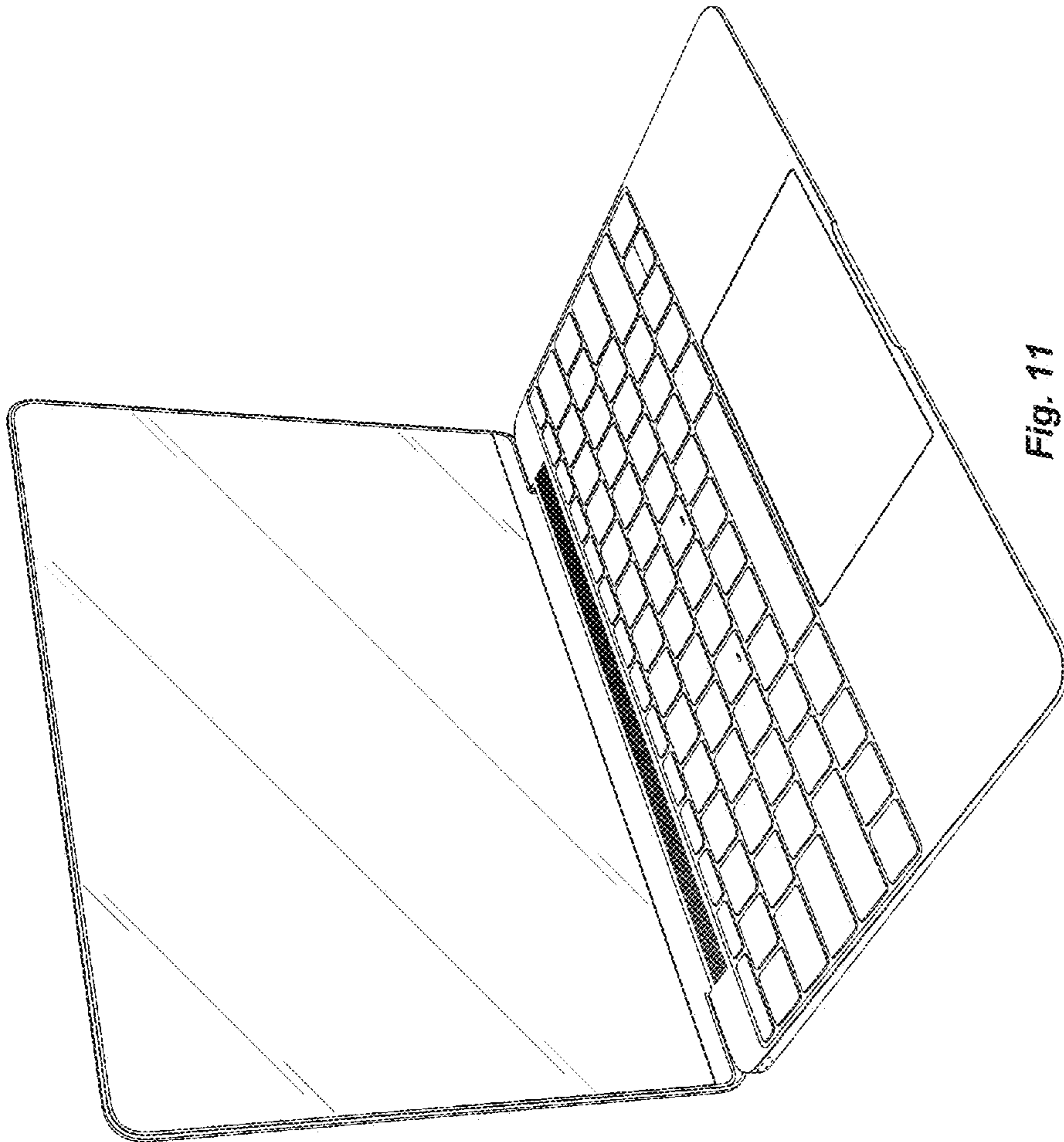

Fig. 11

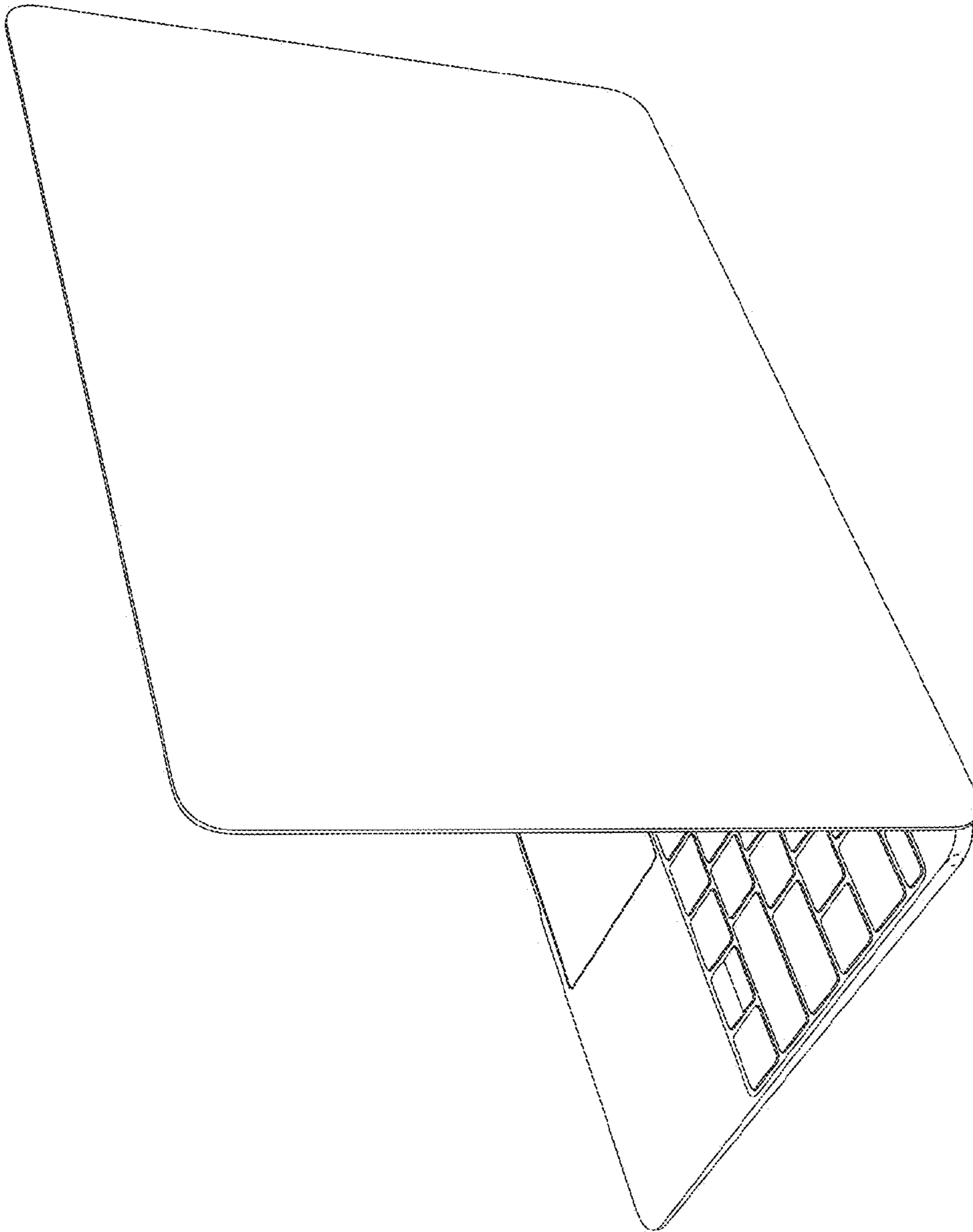

Fig. 12

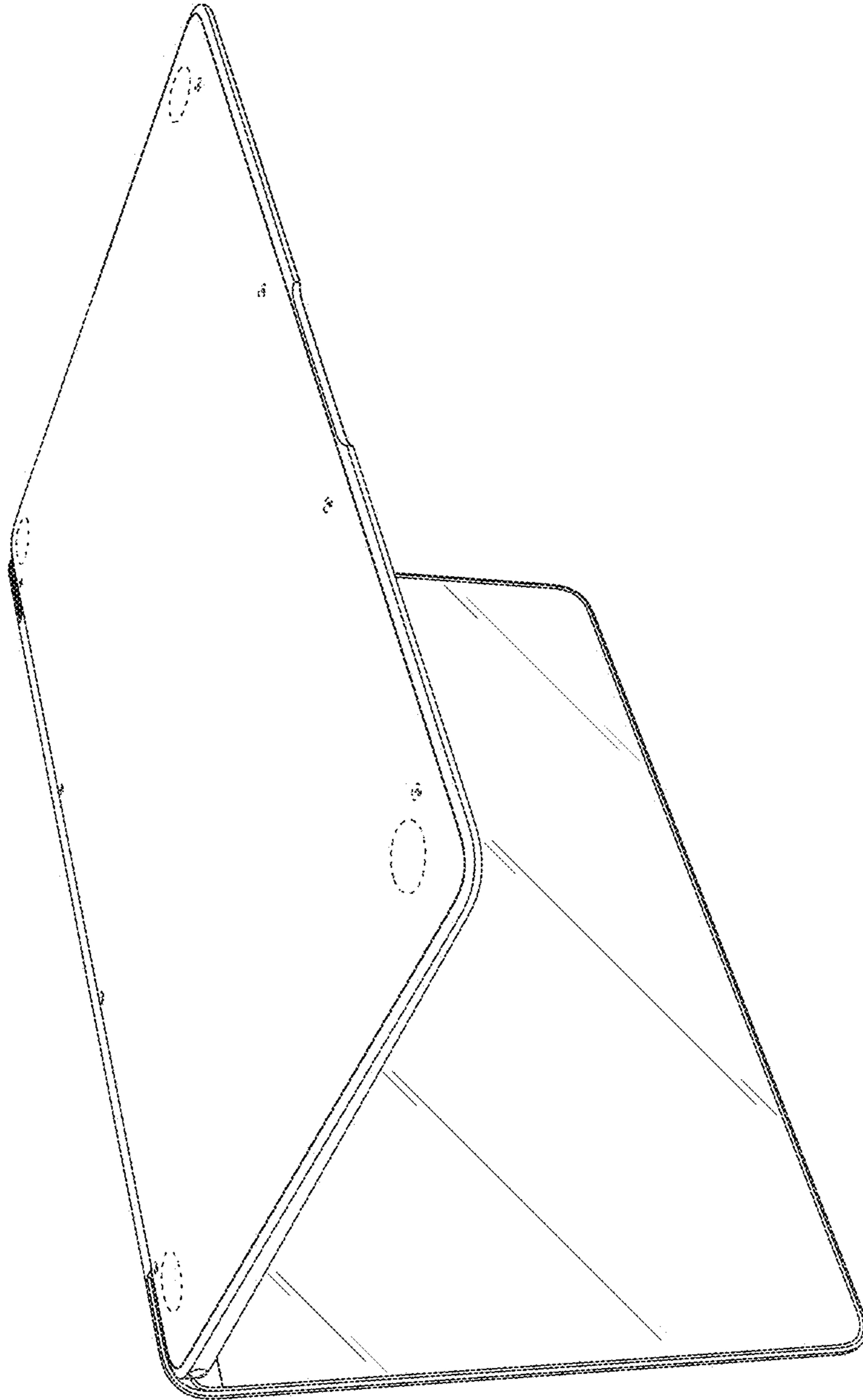

Fig. 13

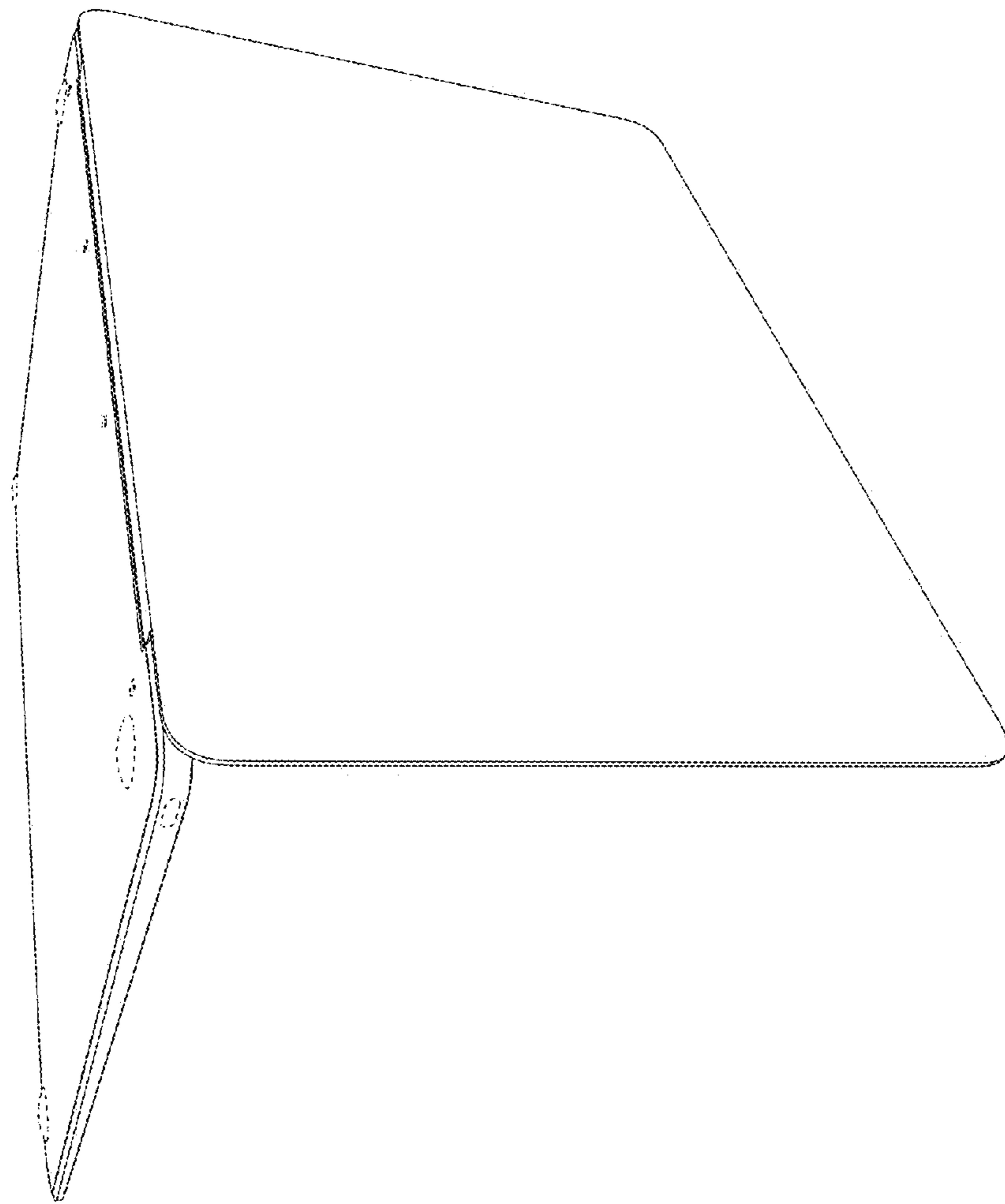

Fig. 14

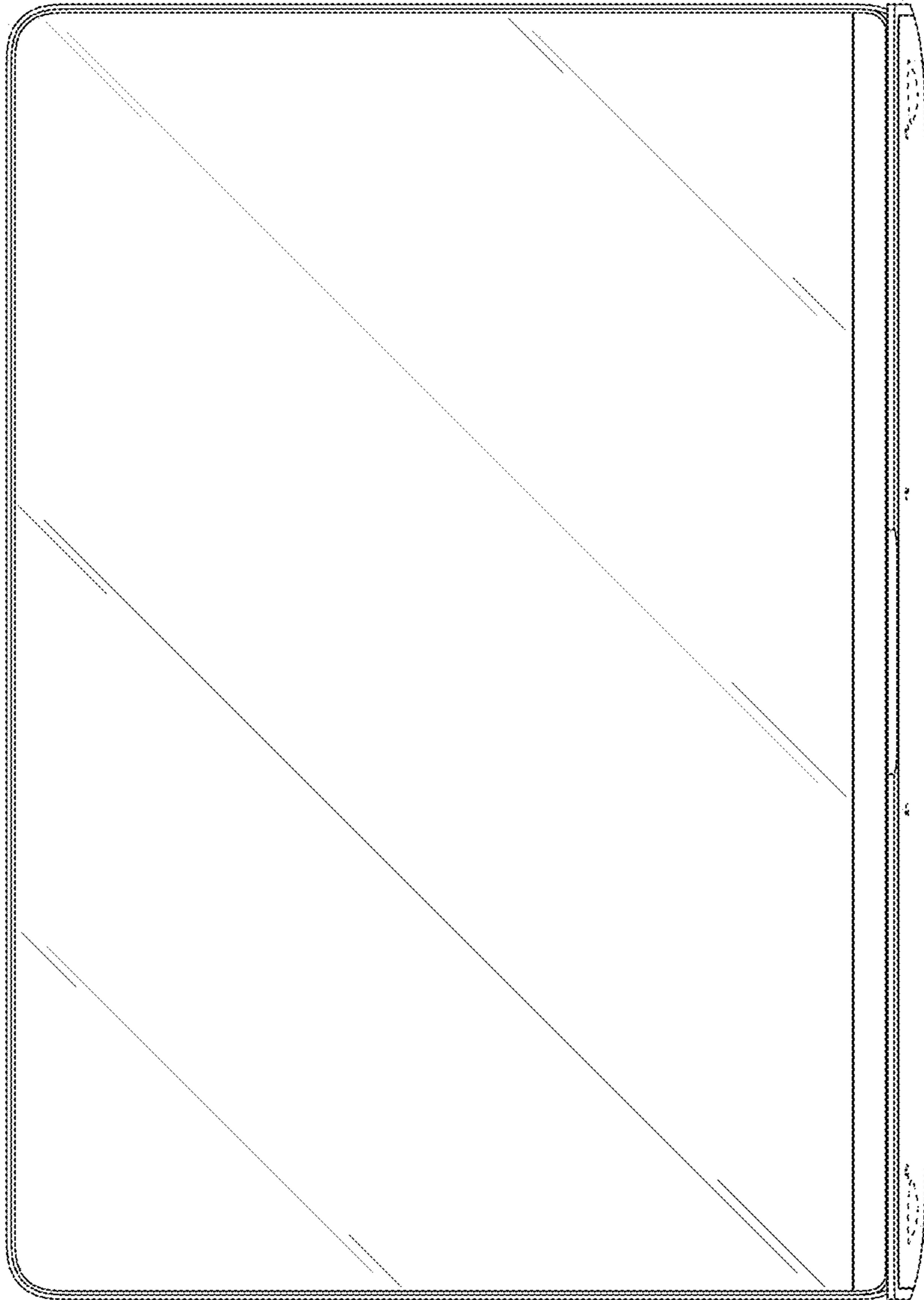

Fig. 15

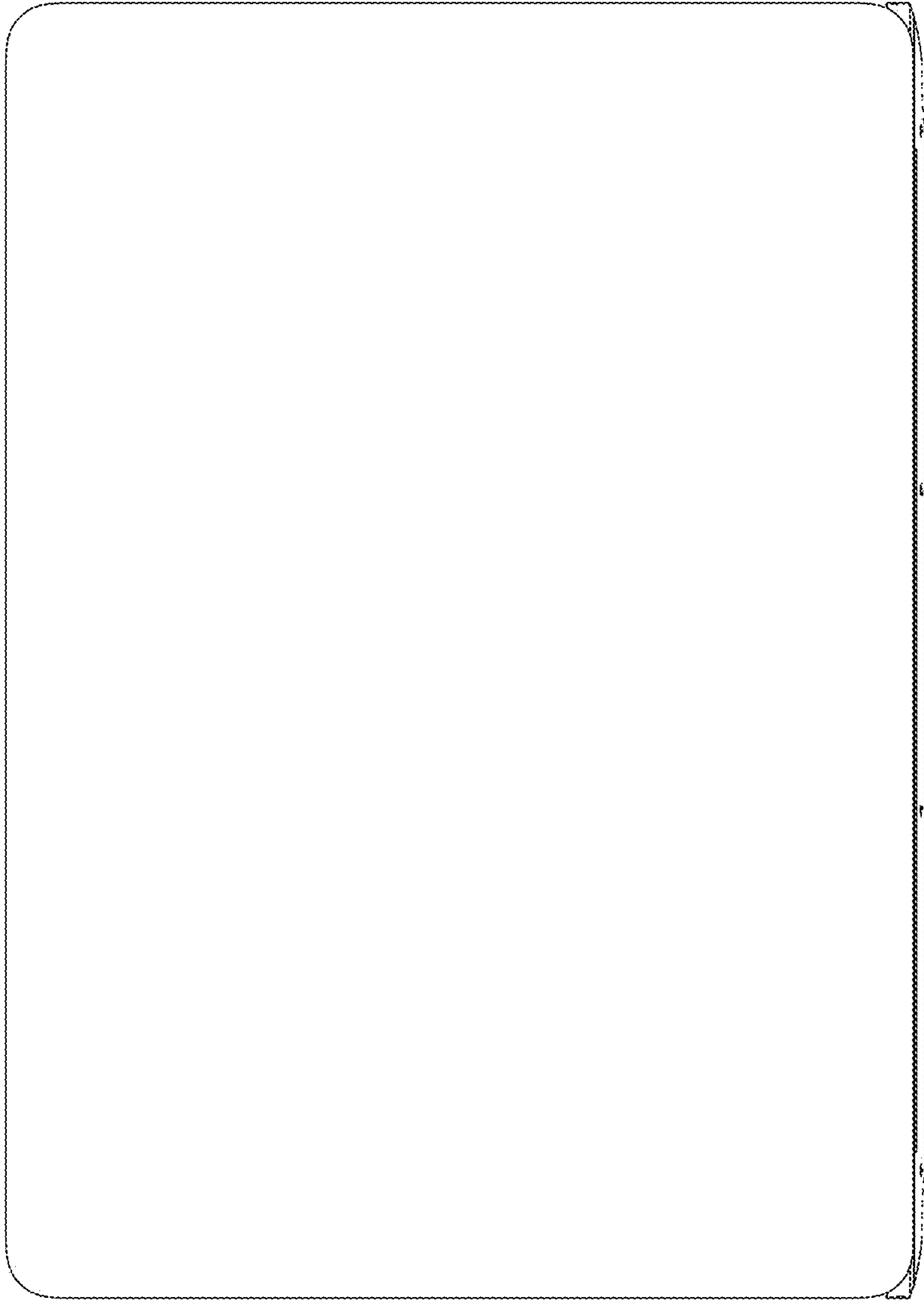

Fig. 16

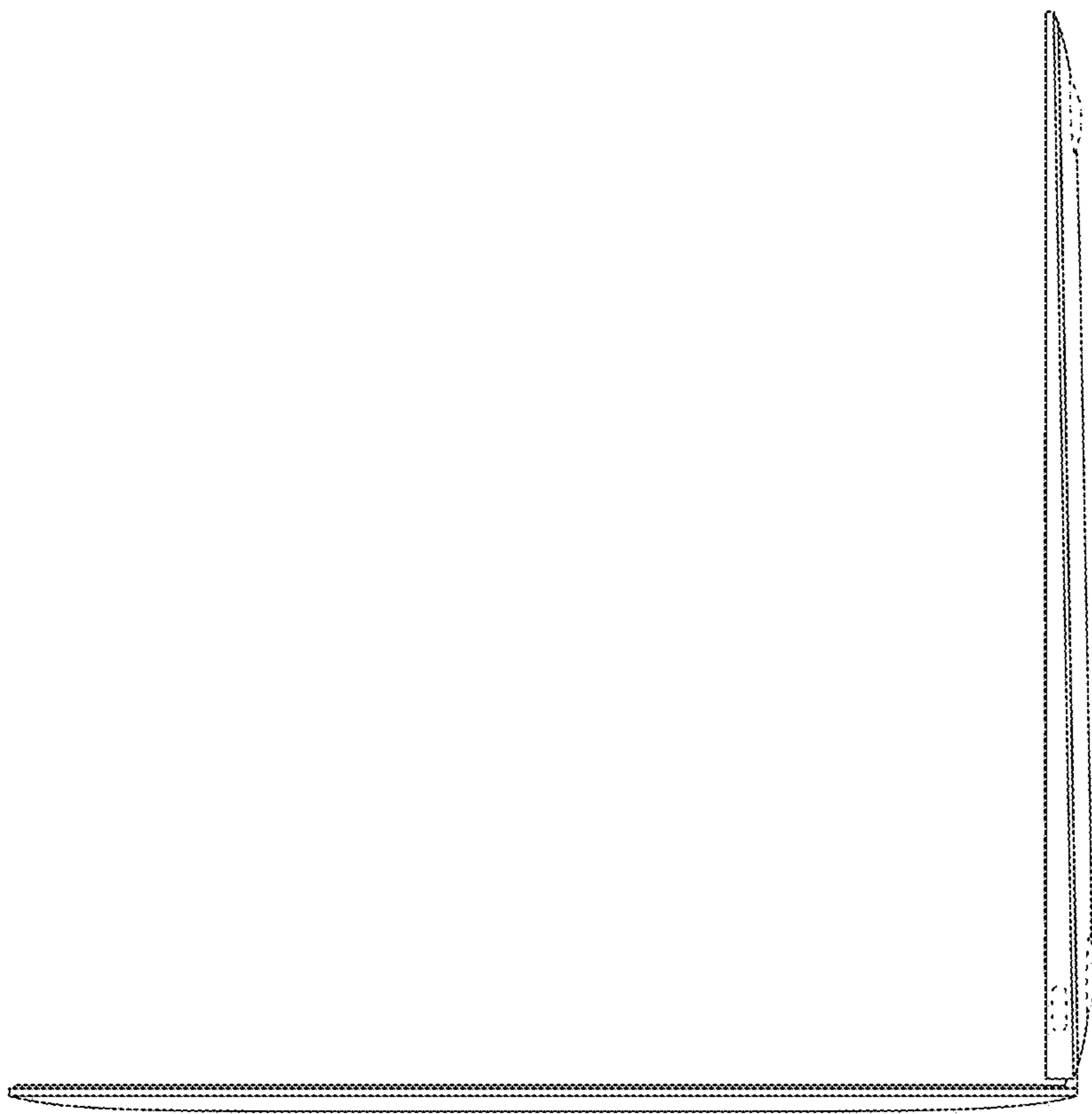

Fig. 17

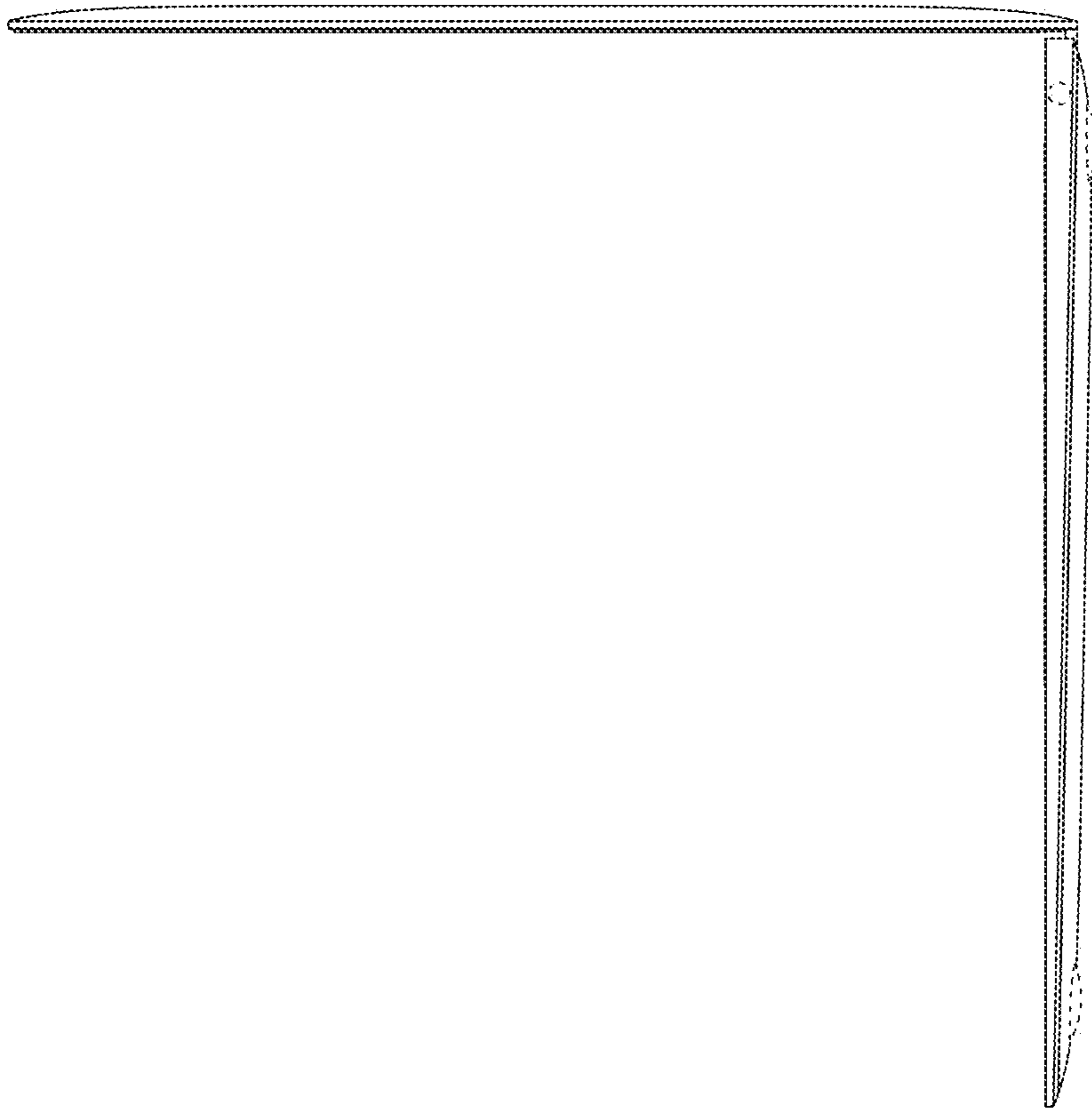

Fig. 18

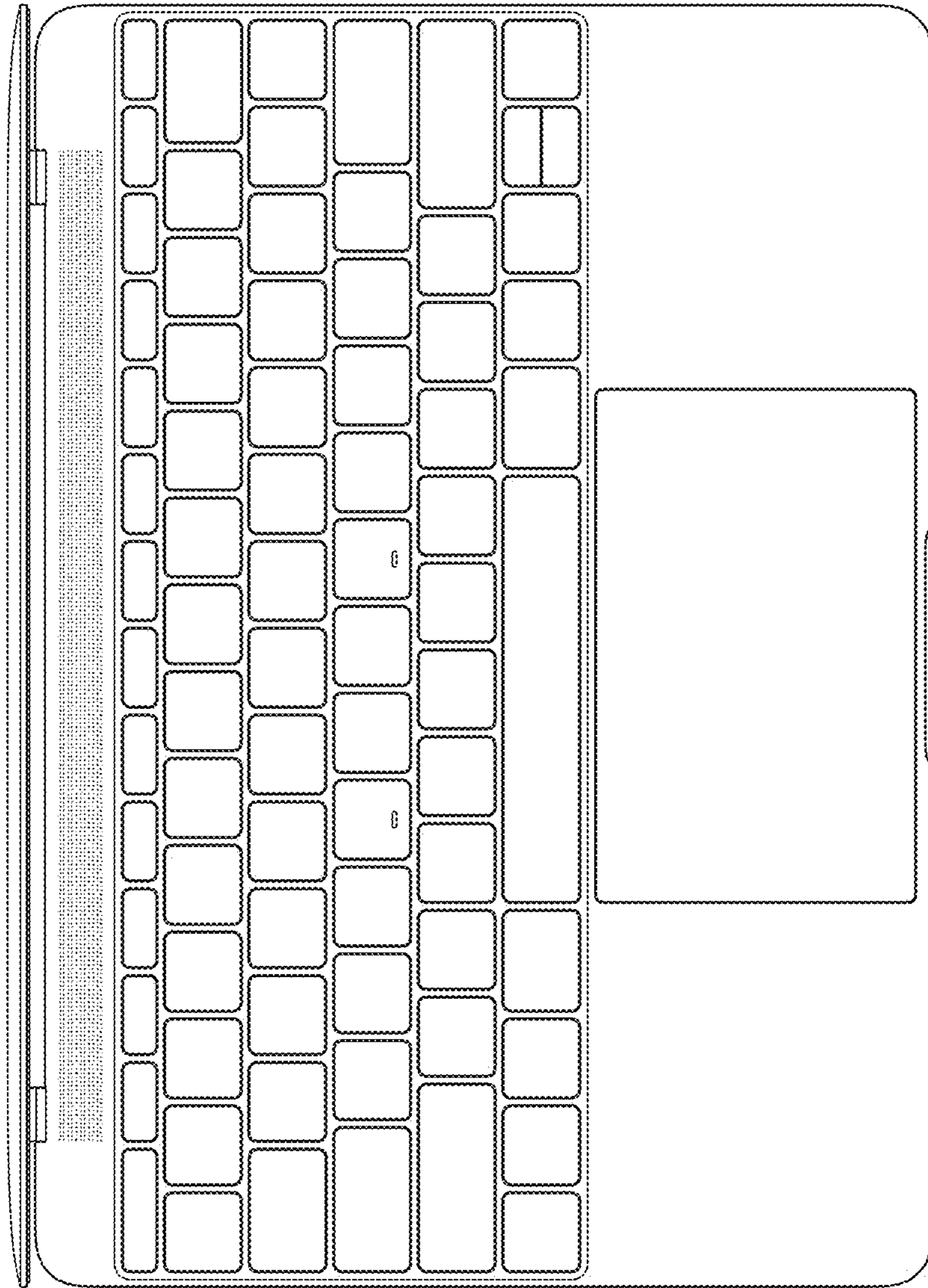

Fig. 19

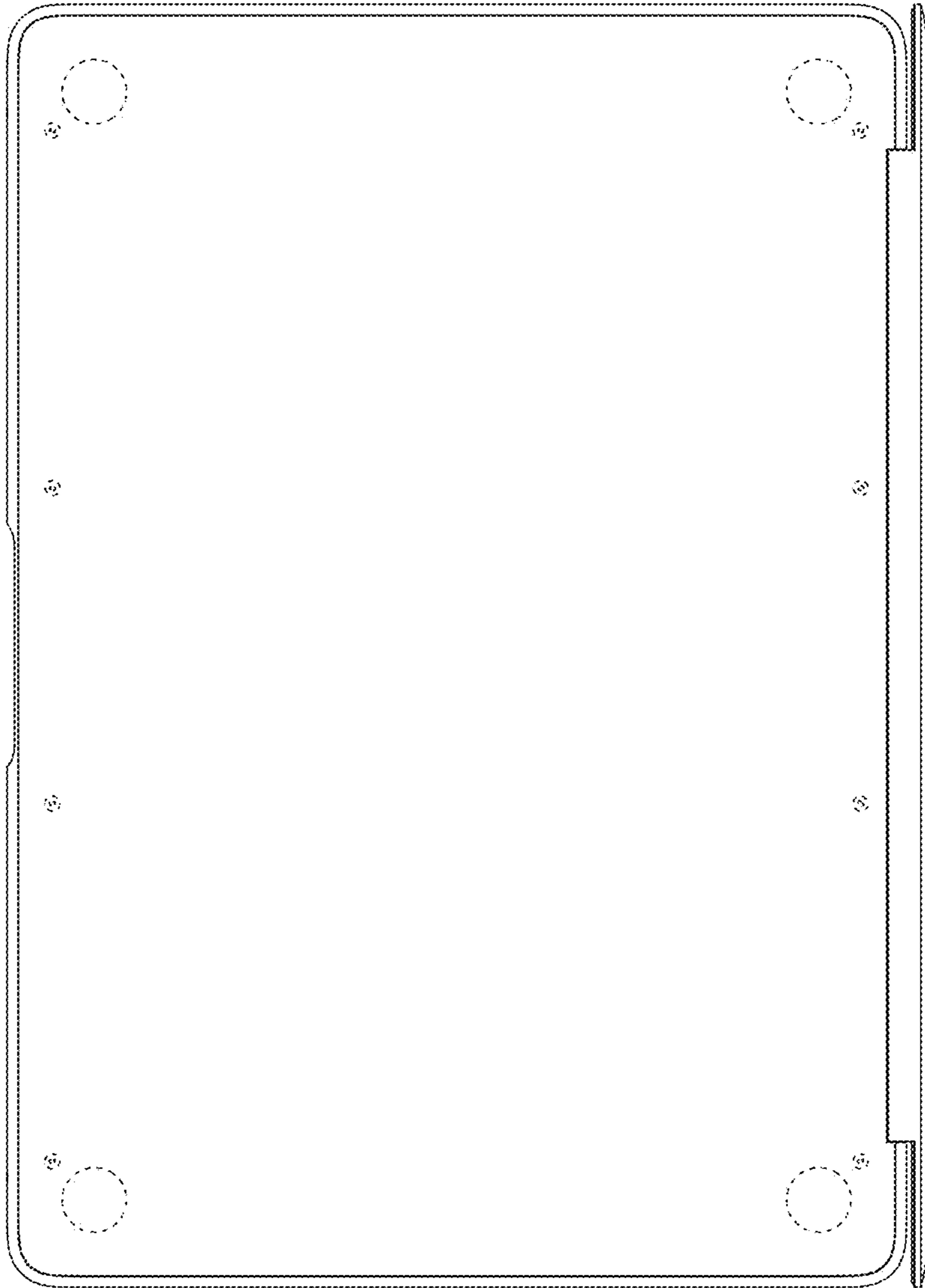

Fig. 20