



US00D776574S

(12) **United States Design Patent**
Griffin et al.

(10) **Patent No.:** **US D776,574 S**
(45) **Date of Patent:** **** Jan. 17, 2017**

- (54) **DELIVERY TRUCK BOX**
- (71) Applicant: **Amazon Technologies, Inc.**, Seattle, WA (US)
- (72) Inventors: **Sherman Griffin**, Seattle, WA (US); **Samuel Pike Hall, VI**, Seattle, WA (US); **Douglas James Herrington**, Seattle, WA (US)
- (73) Assignee: **Amazon Technologies, Inc.**, Seattle, WA (US)
- (**) Term: **14 Years**
- (21) Appl. No.: **29/524,246**
- (22) Filed: **Apr. 17, 2015**
- (51) **LOC (10) Cl.** **12-08**
- (52) **U.S. Cl.**
USPC **D12/97**
- (58) **Field of Classification Search**
USPC D12/93-102, 413; D20/10
CPC B62D 33/04; B62D 53/064; B62D 33/065
See application file for complete search history.

(56) **References Cited**

U.S. PATENT DOCUMENTS

D90,925 S *	10/1933	Robinson	D12/100
D91,721 S *	3/1934	Parrish	D12/103
D94,096 S *	12/1934	Robinson	D12/100
D105,268 S *	7/1937	De Sakhnoffsky	D12/103
D134,718 S *	1/1943	Crawford	D12/84
D181,849 S *	1/1958	Gowl	D12/102
D190,077 S *	4/1961	Myers	D12/99
D191,458 S *	10/1961	Alvaney	D12/97
D194,589 S *	2/1963	Rogers	D12/99
D194,662 S *	2/1963	Zale	D12/102
D199,118 S *	9/1964	McKillop	D12/102

3,423,126 A * 1/1969 Galvin B60J 7/085
296/98
D219,139 S * 11/1970 Bauer D12/12
D231,439 S * 4/1974 Putnman D12/99
(Continued)

OTHER PUBLICATIONS

Amazon's Roving Treasure Truck Delayed In First Weekend Of Business, announced Jun. 29, 2015 [online], [site visited Aug. 9, 2016]. Available from internet, URL: <https://consumerist.com/2015/06/29/amazons-roving-treasure-truck-delayed-in-first-weekend-of-business/>.*

(Continued)

Primary Examiner — Karen Kearney
Assistant Examiner — Karra S Johnson
(74) *Attorney, Agent, or Firm* — Lee & Hayes, PLLC

(57) **CLAIM**

The ornamental design for a delivery truck box, as shown and described.

DESCRIPTION

FIG. 1 is a first perspective view of a delivery truck box, taken from the front;
 FIG. 2 is a second perspective view of the delivery truck box of FIG. 1, taken from the back;
 FIG. 3 is a right-side view of the delivery truck box of FIG. 1;
 FIG. 4 is a left-side view of the delivery truck box of FIG. 1;
 FIG. 5 is a front view of the delivery truck box of FIG. 1;
 FIG. 6 is a back view of the delivery truck box of FIG. 1; and,
 FIG. 7 is a top view of the delivery truck box of FIG. 1.
 The broken lines showing environmental portions of the truck, and features of the delivery truck box, form no part of the claimed design.

1 Claim, 7 Drawing Sheets

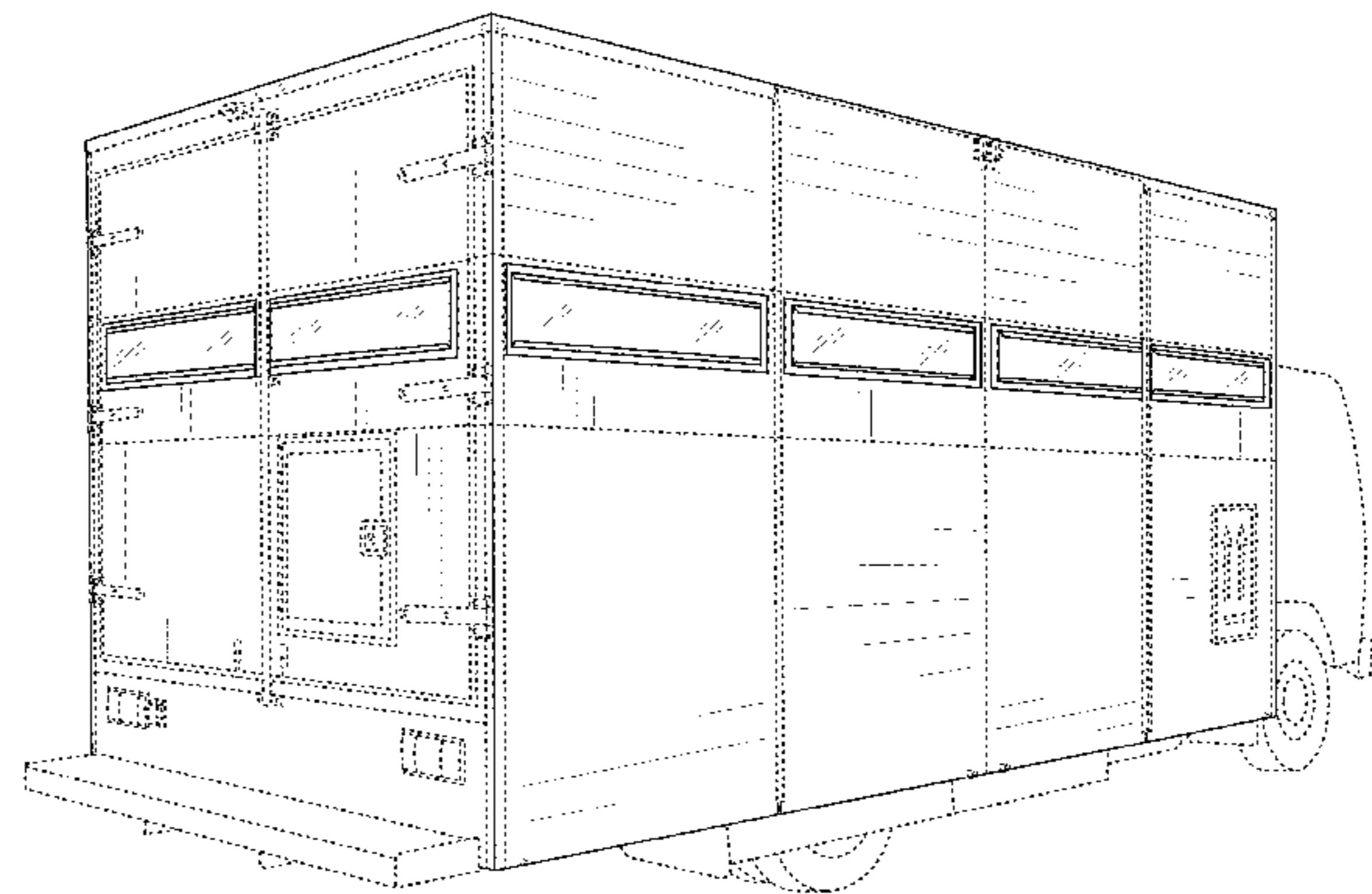
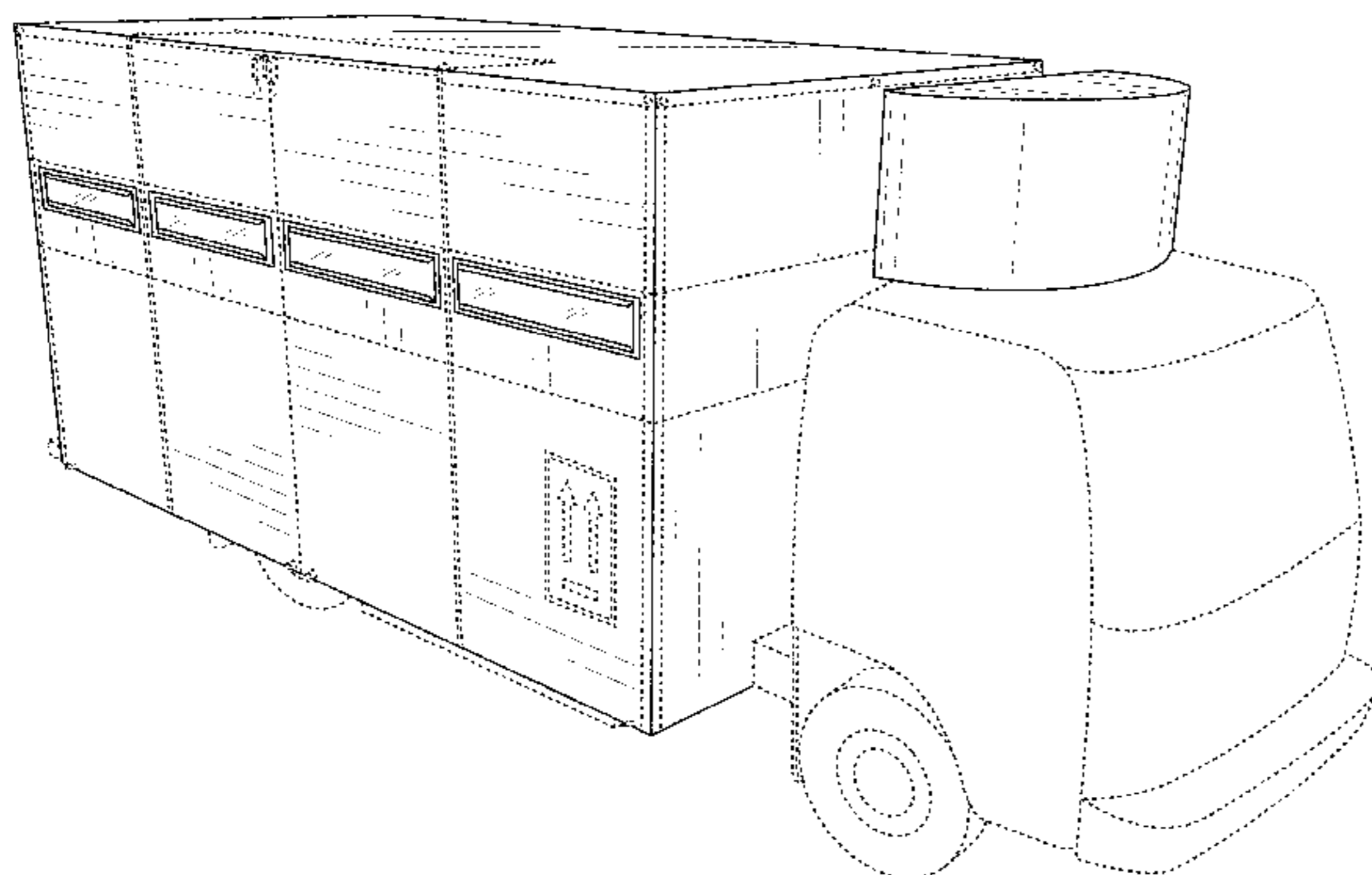

(56)

References Cited

U.S. PATENT DOCUMENTS

D242,581 S * 11/1976 Morris D12/101
 D243,164 S * 1/1977 Knapheide, III D12/98
 D247,290 S * 2/1978 Arnot, Jr. D12/97
 4,103,956 A * 8/1978 Faulstich B60P 3/14
 296/10
 D250,182 S * 11/1978 Fehr D12/98
 D270,245 S * 8/1983 Collins D12/96
 4,437,699 A * 3/1984 Lewis B62D 33/04
 105/409
 D287,113 S * 12/1986 FitzGerald D12/84
 4,659,132 A * 4/1987 Day B60P 3/055
 105/371
 D314,164 S * 1/1991 Barber D12/104
 D342,700 S * 12/1993 Vernese D12/102
 D352,919 S * 11/1994 Marks D12/84
 5,415,451 A * 5/1995 Stanton B60R 13/005
 296/21
 D423,447 S * 4/2000 Lieding D12/413
 D659,595 S * 5/2012 Eliason D12/102
 D678,822 S * 3/2013 Armigliato D12/91
 D689,401 S * 9/2013 Calderon D12/101
 D758,252 S * 6/2016 Murray D12/93
 2006/0248763 A1 * 11/2006 Tarabella G09F 21/04
 40/590

OTHER PUBLICATIONS

Amazon's Treasure Truck Is Like An Ice Cream Truck For Paddleboards And Steaks, announced Jun. 26, 2015 [online], [site visited Aug. 9, 2016]. Available from internet, URL: <<https://consumerist.com/2015/06/26/amazons-treasure-truck-is-like-an-ice-cream-truck-for-paddleboards-and-steaks/>>.*
 Bus LED Destination Sign, announced Mar. 6, 2014 [online], [site visited Aug. 12, 2016]. Available from internet, URL: <<http://www.aesys.com/LED-signs-and-LED-display/bus-systems/on-board-systems/led-destination-sign>>.*
 Get trinkets from new Amazon Treasure Truck, announced Jun. 25, 2016 [online], [site visited Aug. 9, 2016]. Available from internet, URL: <<http://www.seattlepi.com/local/article/Get-trinkets-from-new-Amazon-Treasure-Truck-6349389.php>>.*
 First look at Amazon's Treasure Truck: Getting a deal from Jeff Bezos' 'four-wheeled joy machine', announced Feb. 6, 2016 [online], [site visited Aug. 9, 2016]. Available from internet, URL: <<http://www.geekwire.com/2016/treasure-truck-first-look/>>.*
 LED Message Display, announced Mar. 11, 2010 [online], [site visited Aug. 12, 2016]. Available from internet, URL: <<http://www.ledyuchip.com/solutions/Truck-Rental-LED-Screen-3.html#V7Hff72bDA>>.*
 Mobile Truck LED Display, announced Oct. 23, 2012 [online], [site visited Aug. 12, 2016]. Available from internet, URL: <<http://www.unit-led.com/blog/mobile-truck-led-display.html>>.*

* cited by examiner

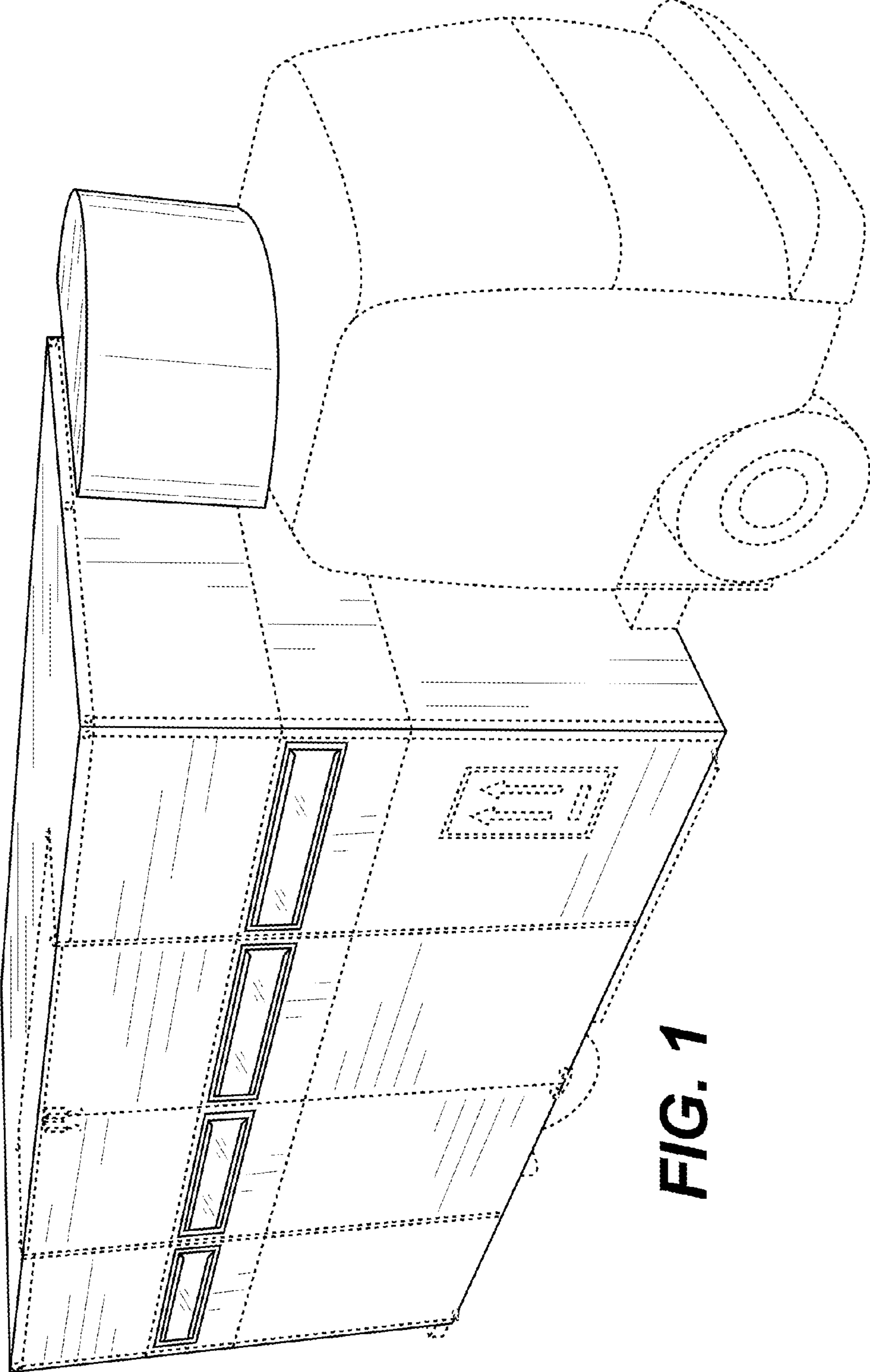

FIG. 1

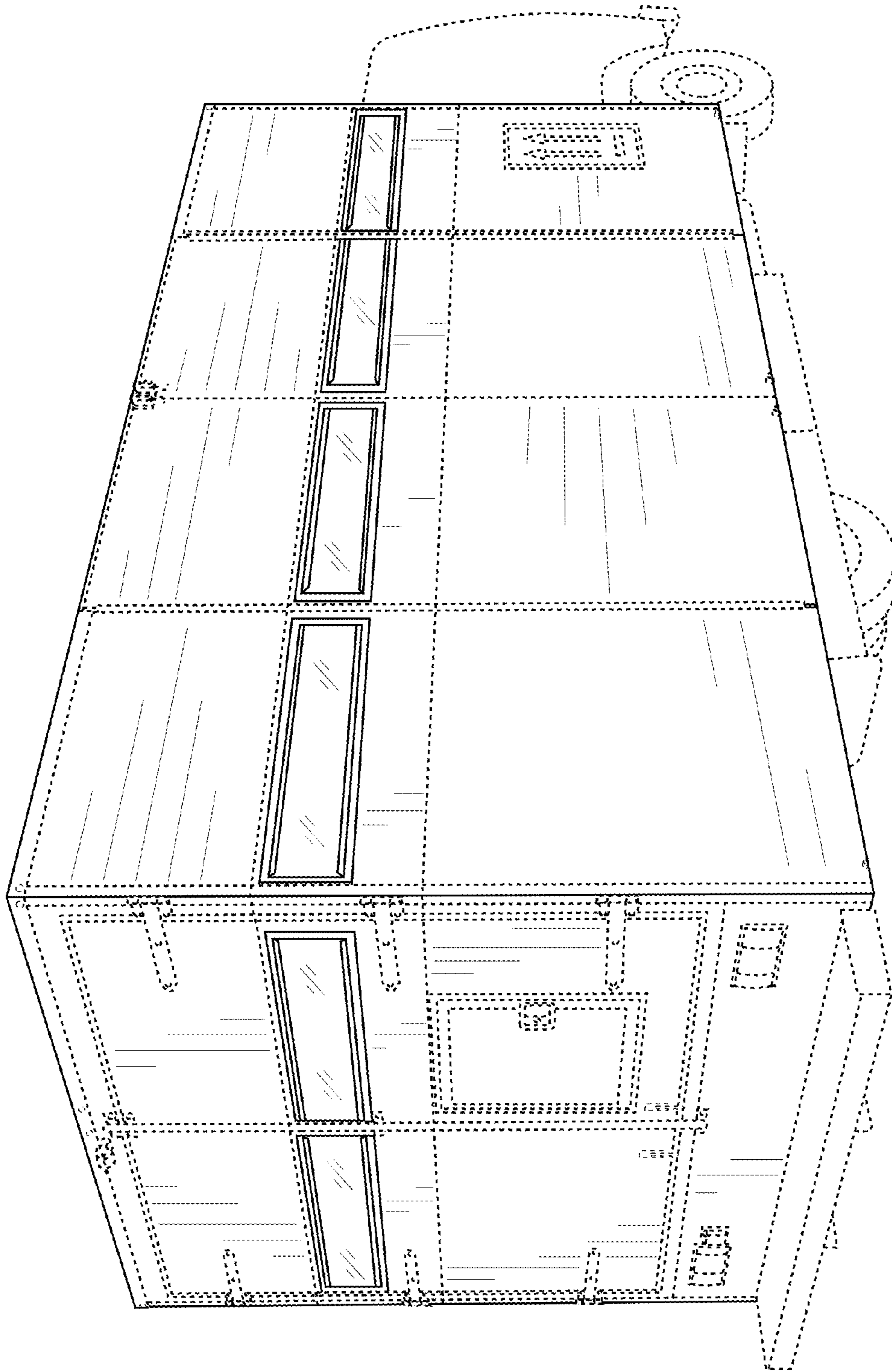

FIG. 2

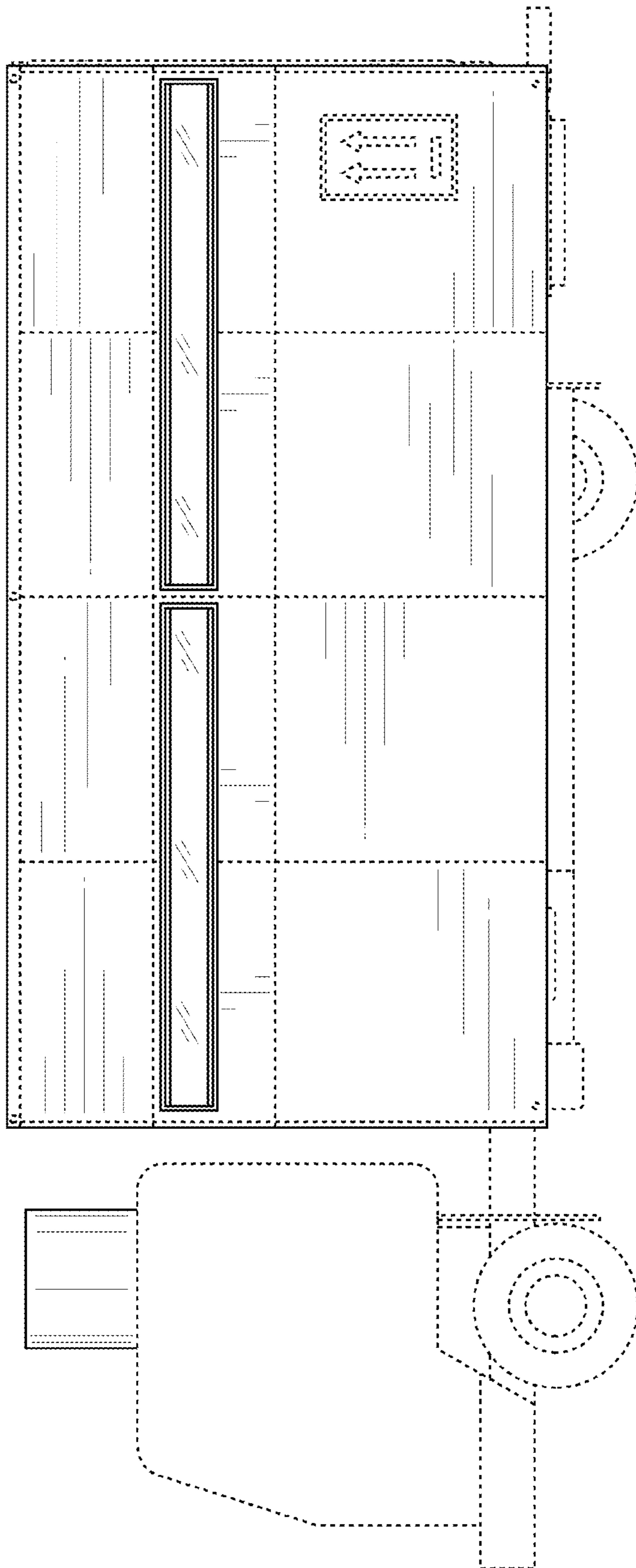

FIG. 3

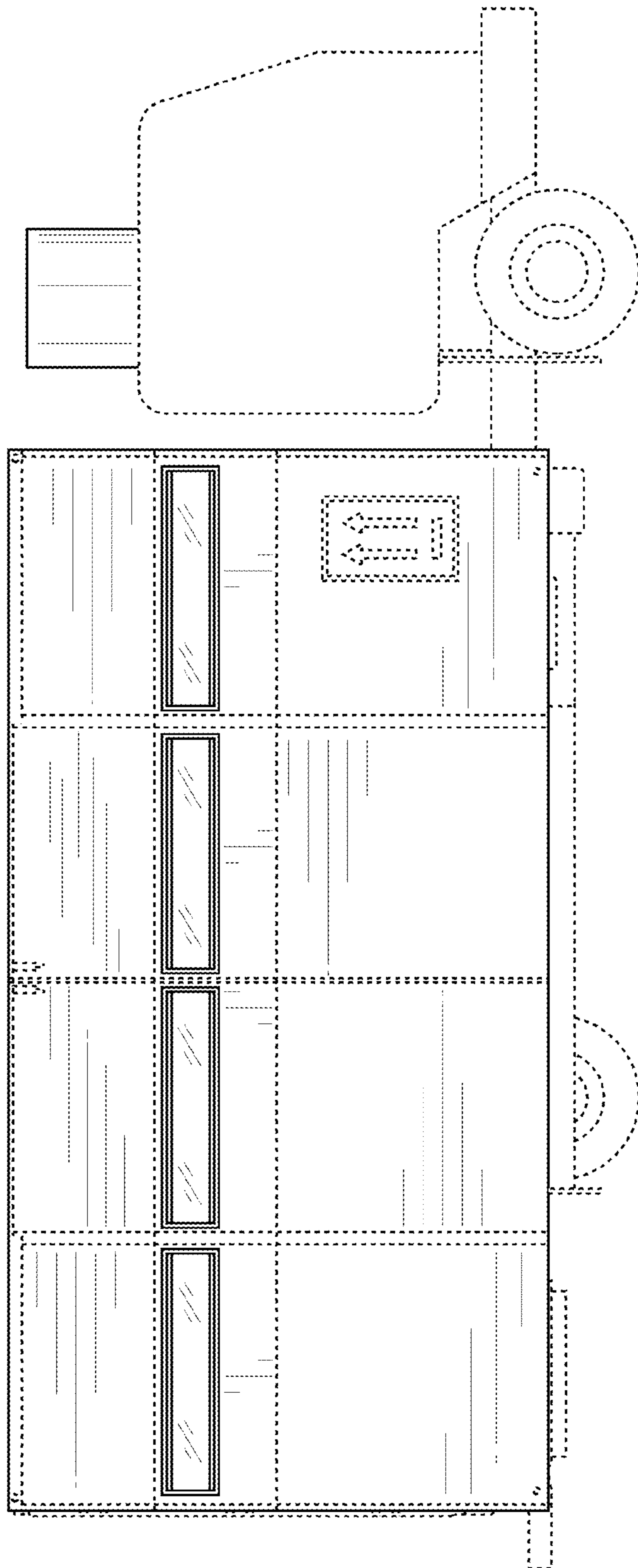

FIG. 4

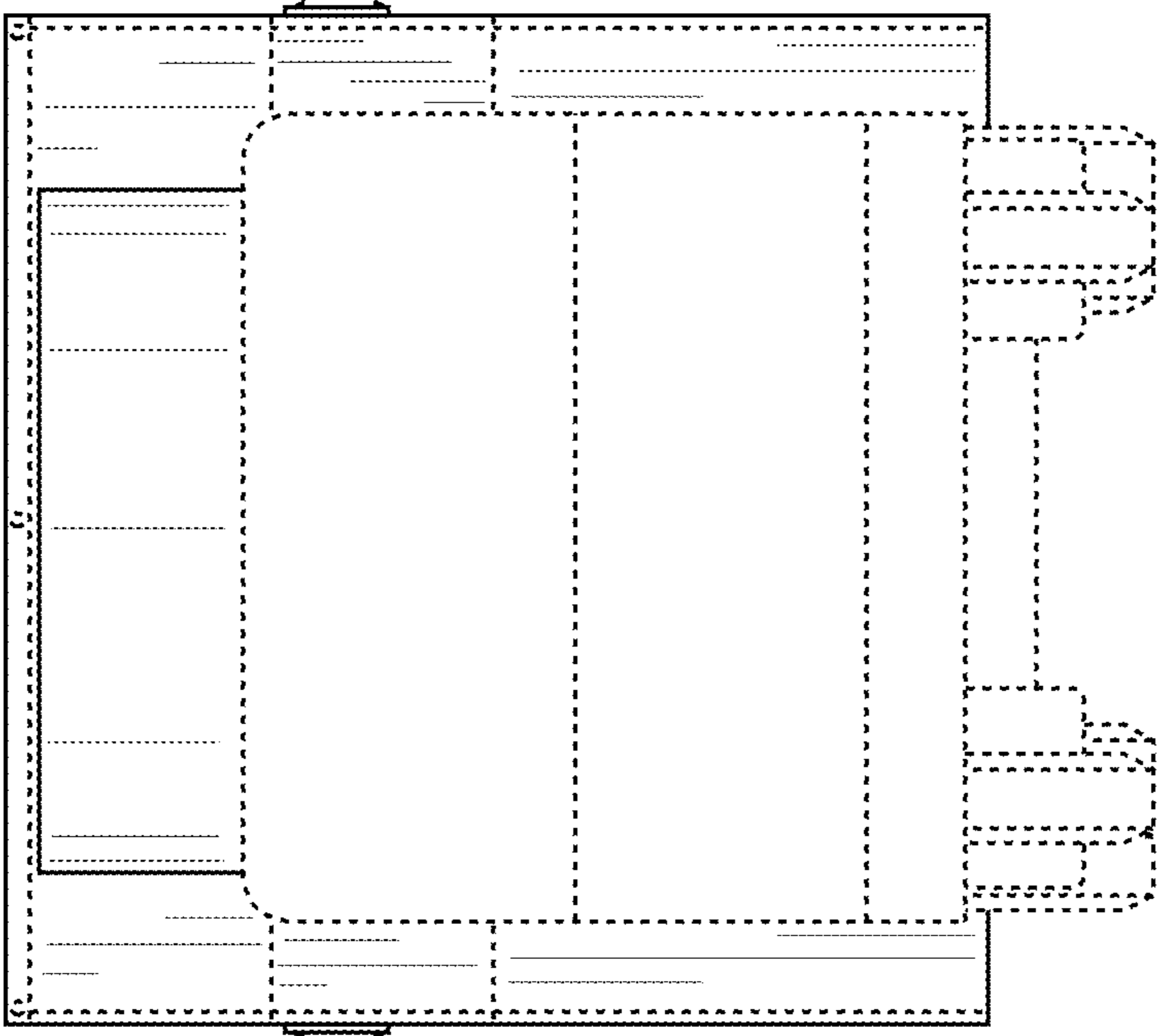

FIG. 5

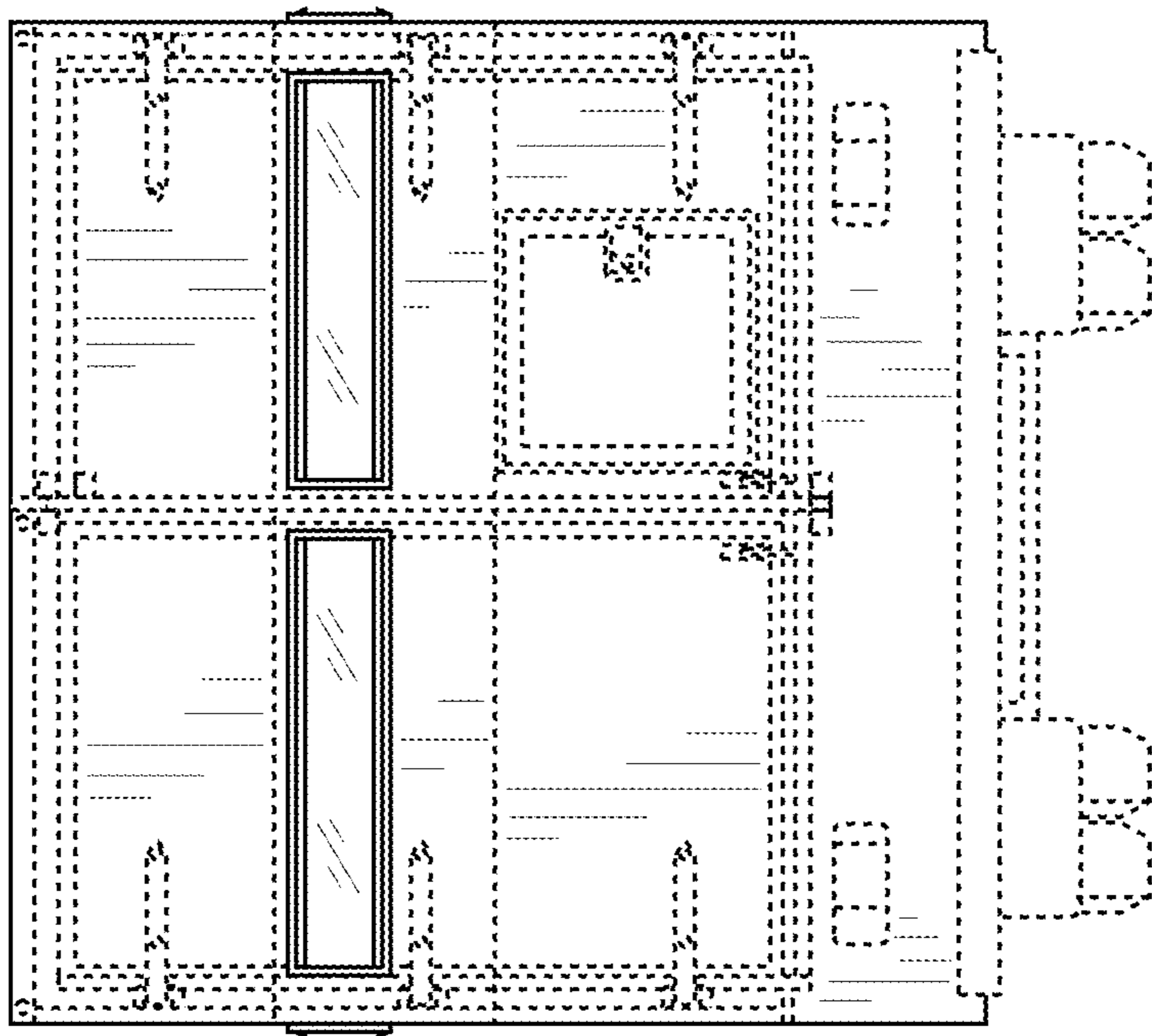

FIG. 6

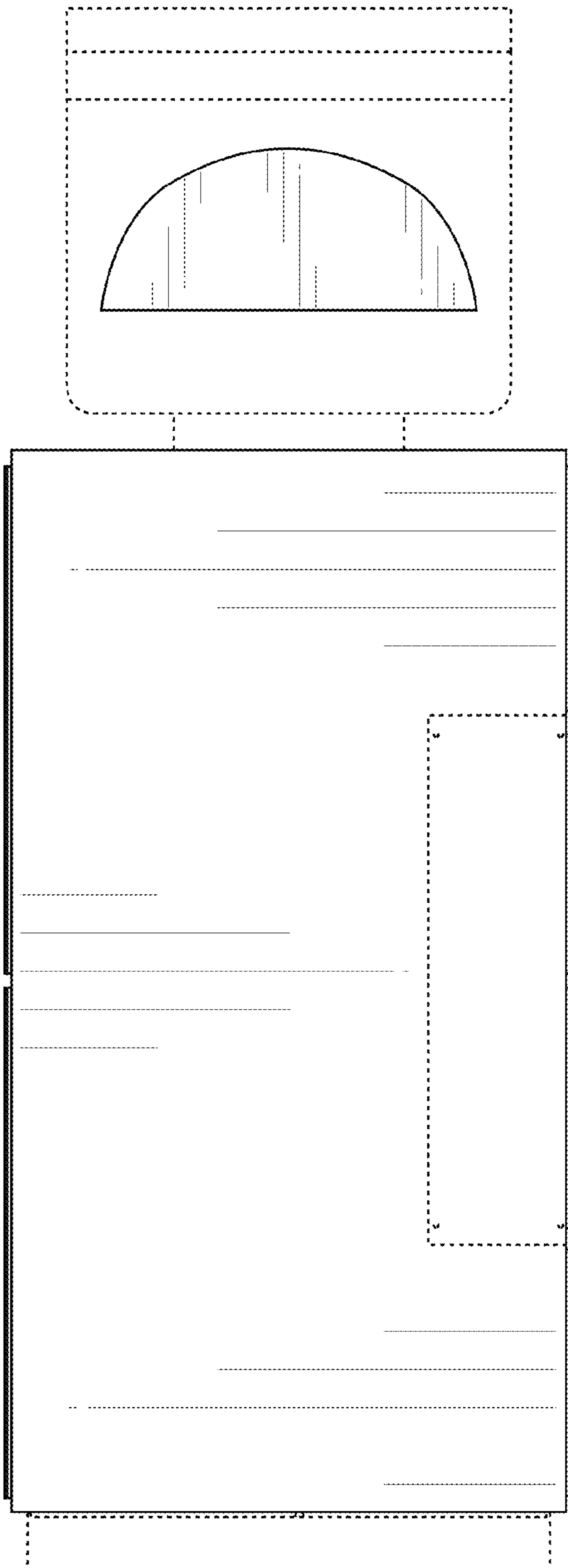

FIG. 7