



US00D776566S

(12) **United States Design Patent** (10) **Patent No.:** **US D776,566 S**
Lee (45) **Date of Patent:** **** Jan. 17, 2017**

(54) **DECORATIVE WINDMILL FRAME** 2,722,773 A * 11/1955 Bonanno A63H 33/30
446/483
(71) Applicant: **Lawrence K. Lee**, Houston, TX (US) D179,960 S * 3/1957 Wood D10/54
D205,460 S * 8/1966 Doty D10/59
(72) Inventor: **Lawrence K. Lee**, Houston, TX (US) D209,349 S * 11/1967 Fleming D15/1
D216,041 S * 11/1969 Luby D26/95
(73) Assignee: **JBL INTERNATIONAL, INC.**, Houston, TX (US) D216,380 S * 12/1969 Redman D6/672
4,248,568 A * 2/1981 Lechner F03D 3/067
416/119

(Continued)

(**) Term: **15 Years**

(21) Appl. No.: **29/526,992**

(22) Filed: **May 14, 2015**

(51) **LOC (10) Cl.** **11-02**

(52) **U.S. Cl.**
USPC **D11/157**

(58) **Field of Classification Search**
USPC D11/157, 131, 117, 164; D10/59;
D21/506-511; D25/7, 25, 1; D6/300-315,
D6/328, 329, 700-702, 709; D26/93, 138,
D26/151; 73/189, 190, 170.05-170.08,
D26/170.11; 446/476, 477, 217, 218;
416/132 B; 362/410-414
CPC Y02E 10/74; Y02E 10/72; A63H 33/40;
A47G 7/02; A47B 97/04; A01G 5/00
See application file for complete search history.

(56) **References Cited**

U.S. PATENT DOCUMENTS

201,286 A * 3/1878 Quie F03D 1/00
416/132 B
509,866 A * 12/1893 Bradford B63H 1/24
416/132 R
D23,688 S * 10/1894 Rowe D6/672
D34,850 S * 7/1901 Attwater D21/510
1,422,602 A * 7/1922 Morris F03D 3/067
416/50
1,546,846 A * 7/1925 Long A63H 33/40
446/217
1,697,376 A * 1/1929 Wasson E21B 35/00
166/75.11
2,414,866 A * 1/1947 Glaser F21S 4/10
135/121

OTHER PUBLICATIONS

Wooden Windmill Tower Plans, available Oct. 14, 2015, [online],
[site visited Aug. 2, 2016]. Available from internet, <URL: <http://freediyfurnitureplans.com/wooden-windmill-tower-plans/>>.*

(Continued)

Primary Examiner — Cathron Brooks
Assistant Examiner — Teddy Falloway
(74) *Attorney, Agent, or Firm* — Egbert Law Offices,
PLLC

(57) **CLAIM**

The ornamental design for a decorative windmill frame, as shown and described.

DESCRIPTION

FIG. 1 is a perspective view of a decorative windmill frame showing my new design.
FIG. 2 is a front view thereof, a rear view being identical;
FIG. 3 is a side view thereof; an opposite side view being identical;
FIG. 4 is a top view thereof;
FIG. 5 is a bottom view thereof; and,
FIG. 6 is a partially exploded perspective view of the decorative windmill frame showing construction of the legs thereof.
The broken lines shown in FIGS. 1 and 6 illustrate portions of the decorative windmill frame that form no part of the claimed design.

1 Claim, 3 Drawing Sheets

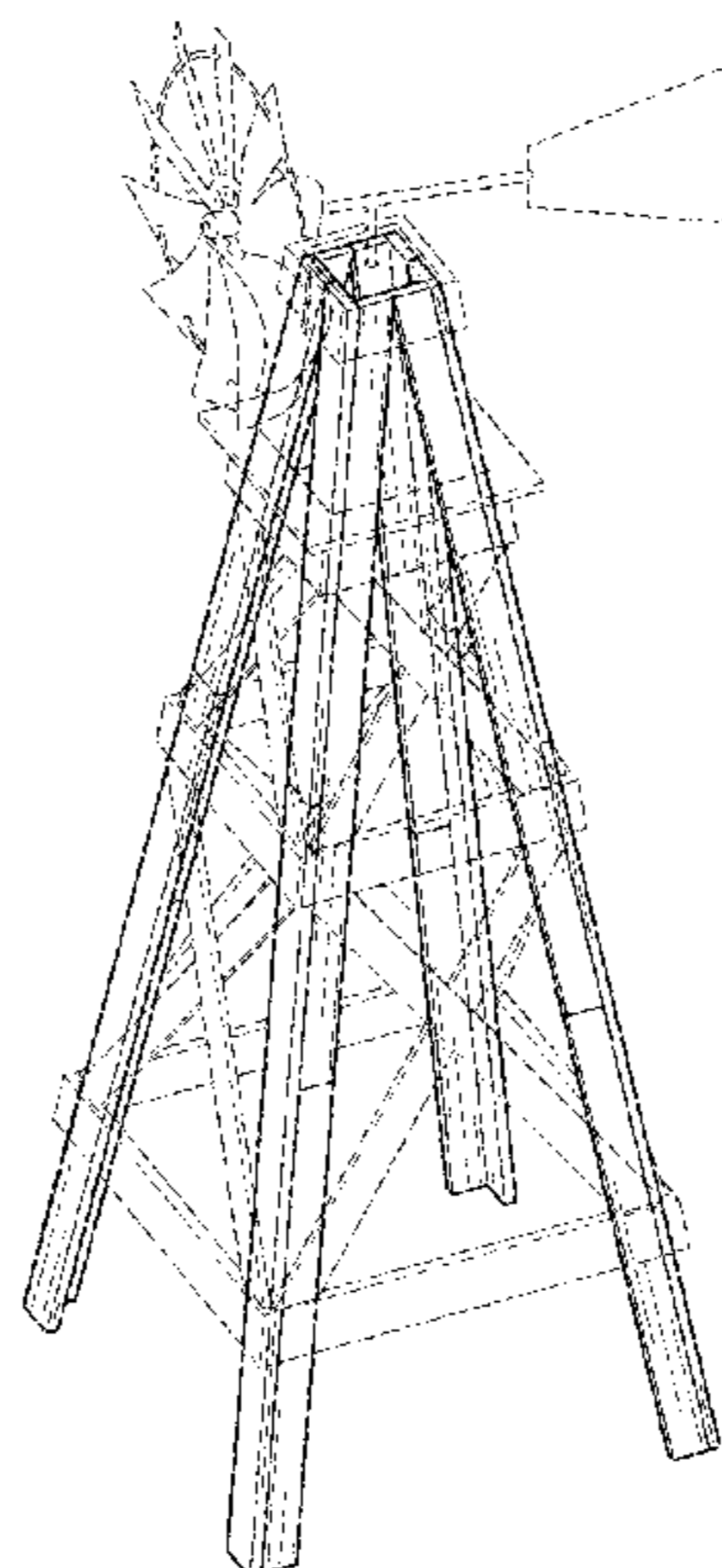

(56)

References Cited

U.S. PATENT DOCUMENTS

D268,690 S * 4/1983 Bennett D21/483
 4,382,191 A * 5/1983 Potter F03D 3/02
 290/44
 4,519,789 A * 5/1985 Halford A63H 18/028
 238/10 E
 D279,293 S * 6/1985 Sutz D15/1
 5,457,346 A * 10/1995 Blumberg F03D 1/04
 290/44
 D443,535 S * 6/2001 Tai D10/59
 D458,185 S * 6/2002 Harklau D11/157
 D494,780 S * 8/2004 Harwanko D6/675.1
 D557,941 S * 12/2007 Valentini D6/681.2
 7,345,374 B1 * 3/2008 Jones F03D 9/007
 290/44
 7,385,304 B1 * 6/2008 Wohlert F03D 1/065
 290/44
 D605,422 S * 12/2009 Wenning D6/672
 D617,113 S * 6/2010 Wenning D6/672
 D664,888 S * 8/2012 Villiers D11/131
 D682,732 S * 5/2013 Dubow D11/157
 D707,155 S * 6/2014 Lee D11/164
 D740,482 S * 10/2015 Wanders D26/93
 2007/0014663 A1 * 1/2007 Chio F03D 3/064
 416/9

2008/0187432 A1 * 8/2008 Cowan F03D 3/005
 415/4.4
 2008/0273975 A1 * 11/2008 Chio F03D 3/064
 416/9
 2009/0086465 A1 * 4/2009 St-Germain F03D 3/005
 362/89
 2009/0230692 A1 * 9/2009 Lopez F03D 9/001
 290/55
 2012/0061968 A1 * 3/2012 Burrell F03B 17/067
 290/55

OTHER PUBLICATIONS

Garden Windmill, available May 2, 2016, [online], [site visited Aug. 2, 2016]. Available from internet, <URL: <http://www.laurensthoughts.com/windmill-garden/high-resolution-windmill-garden-1-garden-windmill/>.*

Vertical Garden Pyramid Tower, available Apr. 30, 2013, [online], [site visited Aug. 2, 2016]. Available from internet, <URL: <http://removeandreplace.com/2013/04/02/how-to-build-a-vertical-garden-pyramid-tower-for-your-next-diy-outdoor-project/>.*

Pyramid Trellis (via my garden trellis blog), available Mar. 2, 2015, [online], [site visited Aug. 2, 2016]. Available from internet, <URL: <http://mygardentrellis.com/>.*

* cited by examiner

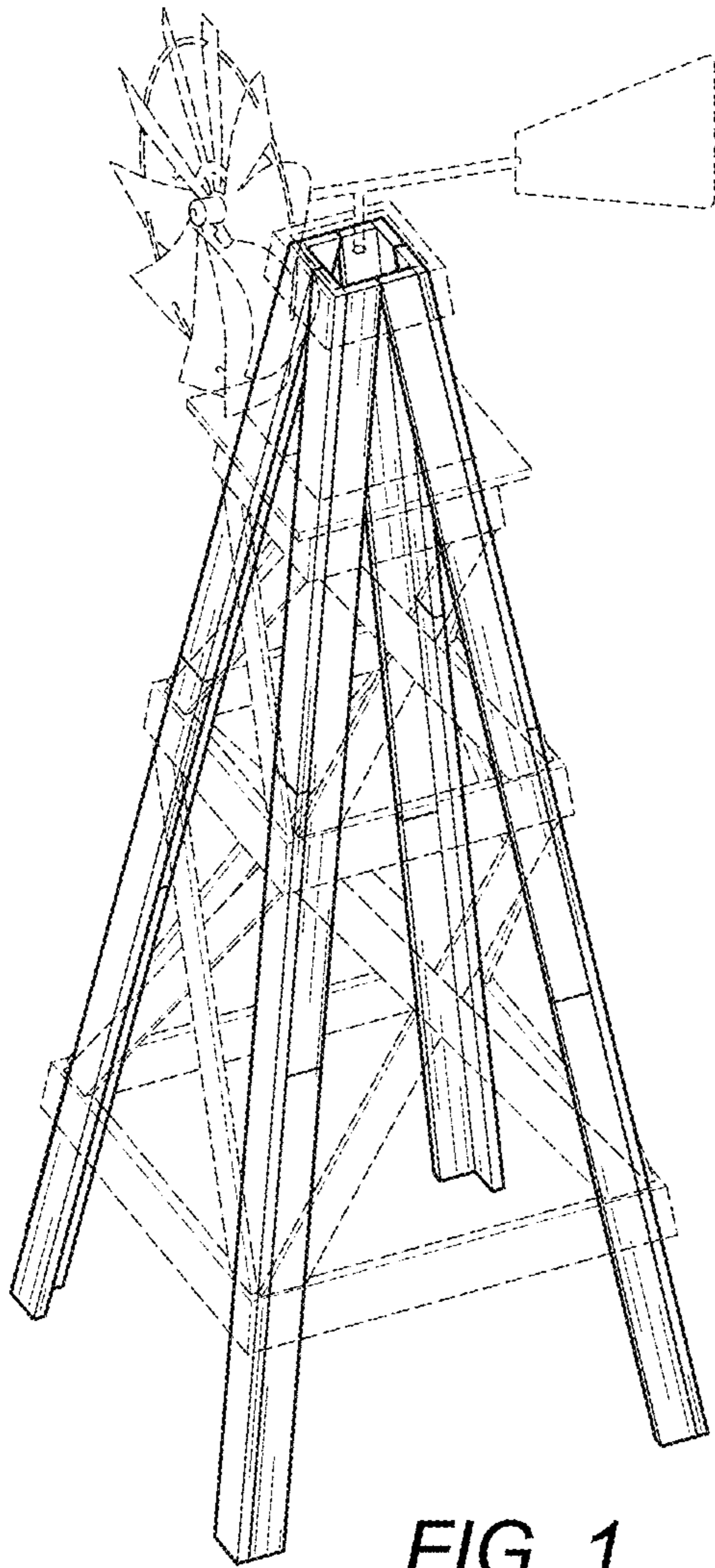

FIG. 1

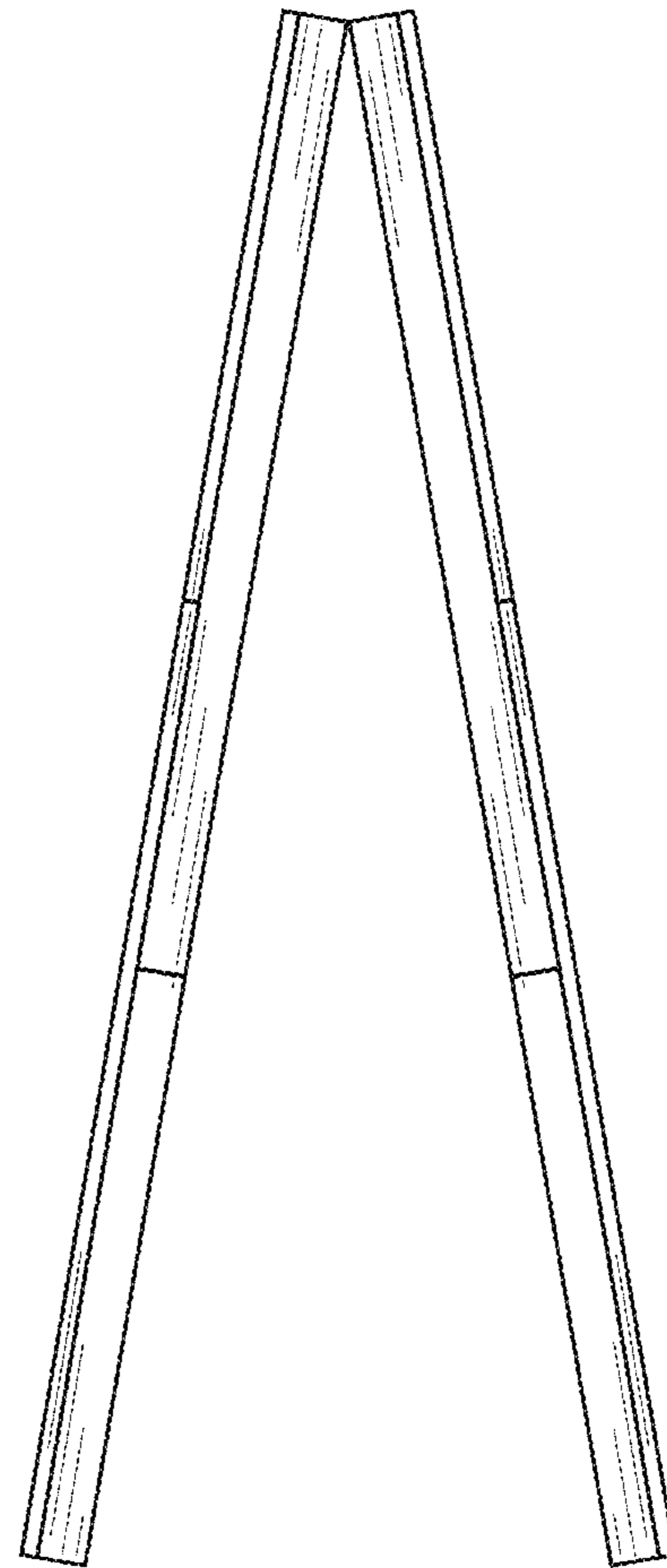

FIG. 2

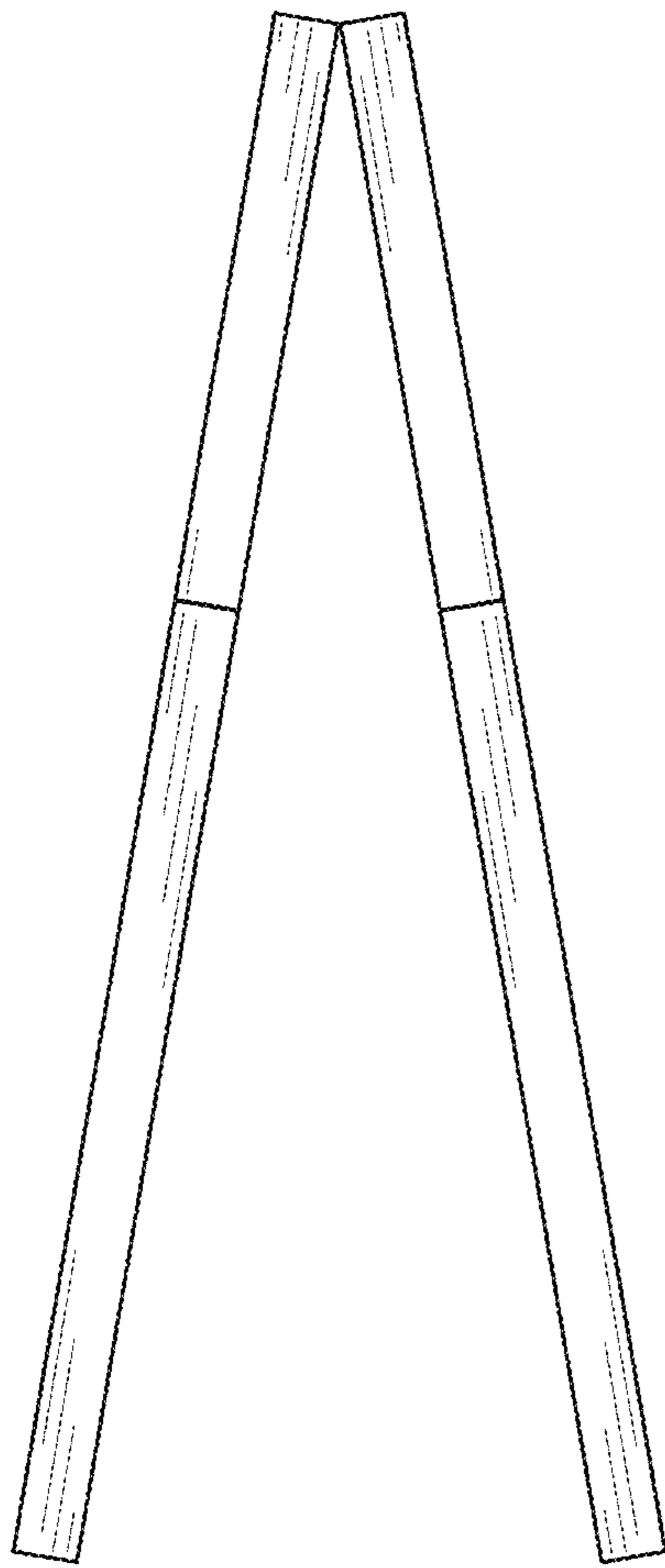

FIG. 3

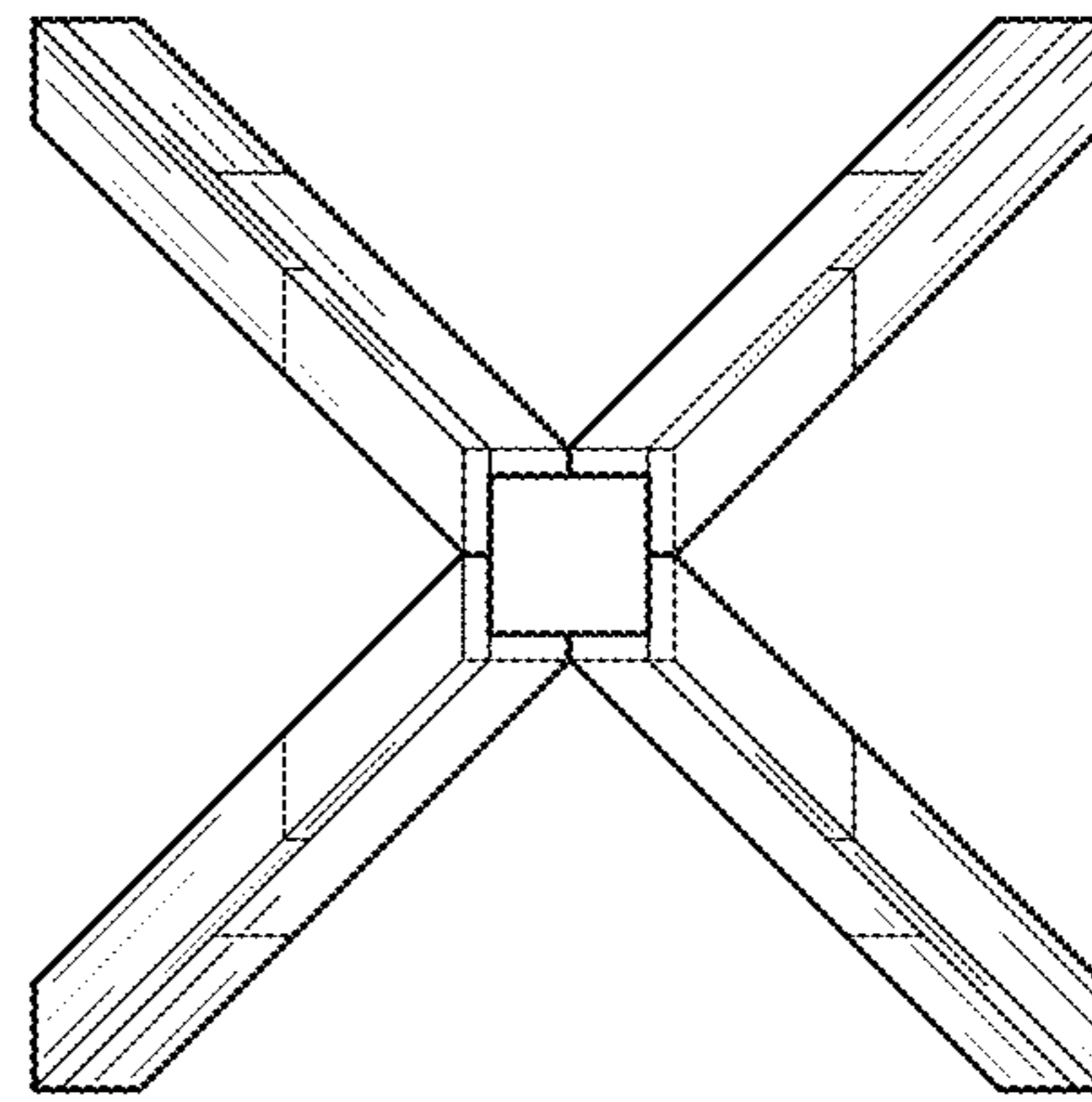

FIG. 4

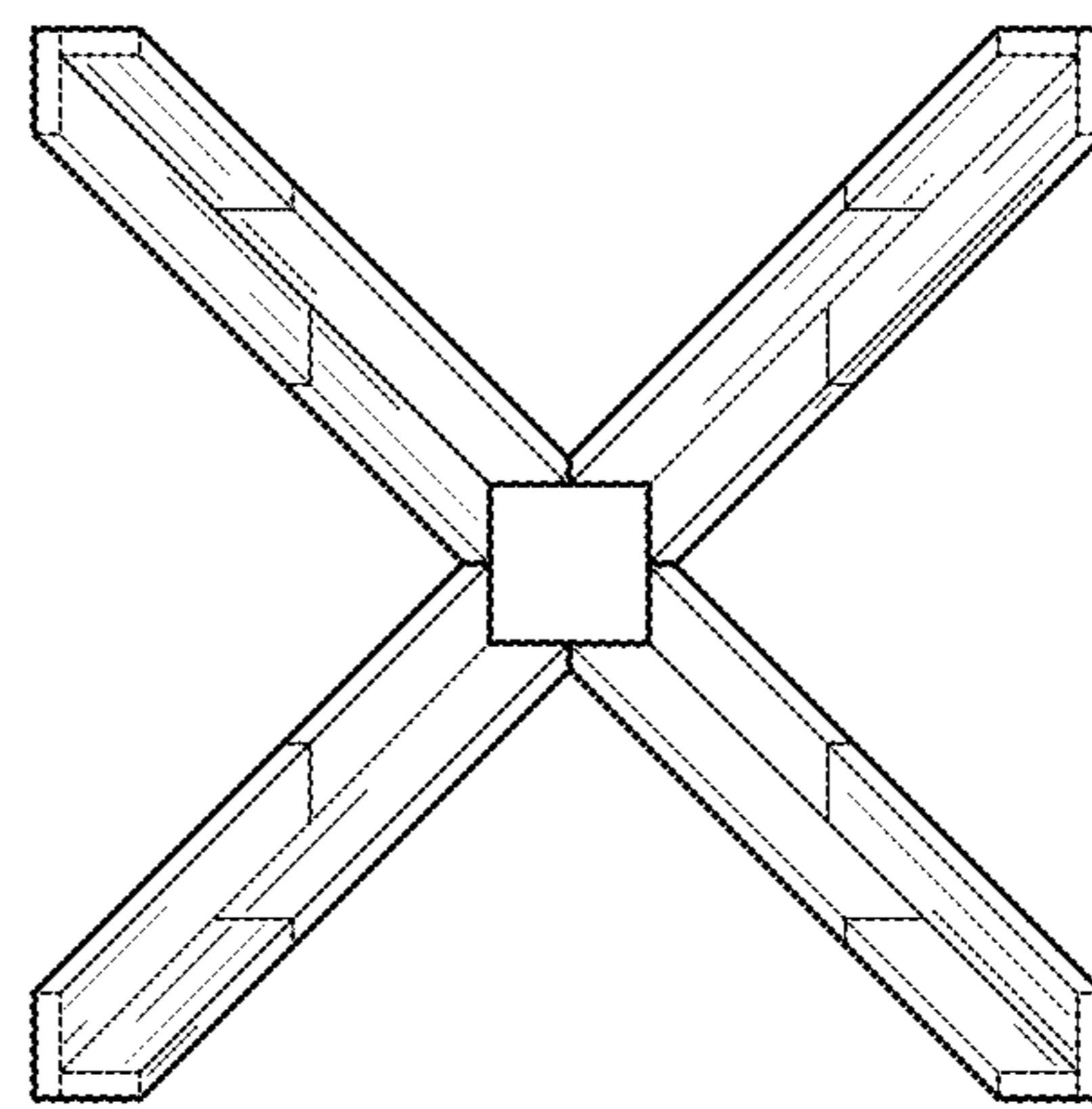

FIG. 5

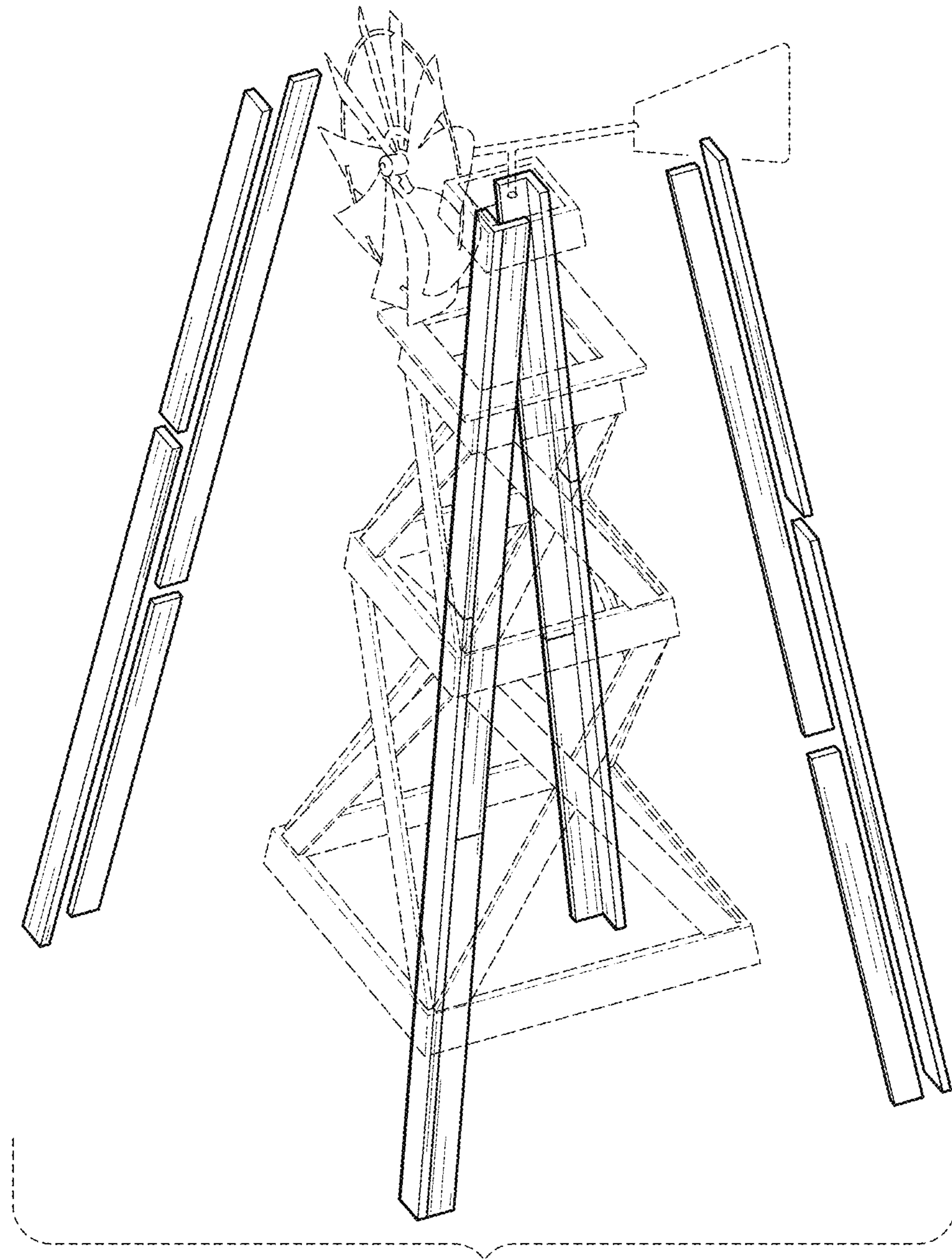

FIG. 6