



US00D776431S

(12) **United States Design Patent**
Braendle

(10) **Patent No.:** **US D776,431 S**

(45) **Date of Patent:** **** Jan. 17, 2017**

(54) **ZIPPER BAG CLOSURE**

(71) Applicant: **Enderson Bagware AG**, Hinwil (CH)

(72) Inventor: **Christoph Braendle**, Hinwil (CH)

(**) Term: **15 Years**

(21) Appl. No.: **29/537,395**

(22) Filed: **Aug. 25, 2015**

(51) **LOC (10) Cl.** **03-01**

(52) **U.S. Cl.**
USPC **D3/318**

(58) **Field of Classification Search**
USPC D3/318, 301
CPC A45C 1/06; A44B 19/00
See application file for complete search history.

(56) **References Cited**

U.S. PATENT DOCUMENTS

D407,432 S *	3/1999	Tell	D19/26
D477,134 S *	7/2003	Palmer	D3/218
D479,652 S *	9/2003	Hassett	D3/289
D497,051 S *	10/2004	Nieves	D3/301
D639,064 S *	6/2011	Raible	D3/301
D640,054 S *	6/2011	Custer	D3/274

D687,376 S *	8/2013	Farris-Gilbert	D13/108
D723,280 S *	3/2015	Sanz	D3/289
D727,621 S *	4/2015	Lai	D3/279
D748,915 S *	2/2016	Reyes	D3/301

* cited by examiner

Primary Examiner — Holly Baynham

(74) *Attorney, Agent, or Firm* — Dykema Gossett PLLC

(57) **CLAIM**

I claim the ornamental design for a zipper bag closure, as shown and described.

DESCRIPTION

FIG. 1 is a perspective view of the portion of the bag showing my new design.
FIG. 2 is a front view thereof.
FIG. 3 is a back view thereof.
FIG. 4 is a left side view thereof.
FIG. 5 is a right side view thereof.
FIG. 6 is a top view thereof; and,
FIG. 7 is a bottom thereof.

The broken lines showing portions of a bag are for the purposes of illustrating environment and form no part of the claimed design.

1 Claim, 7 Drawing Sheets



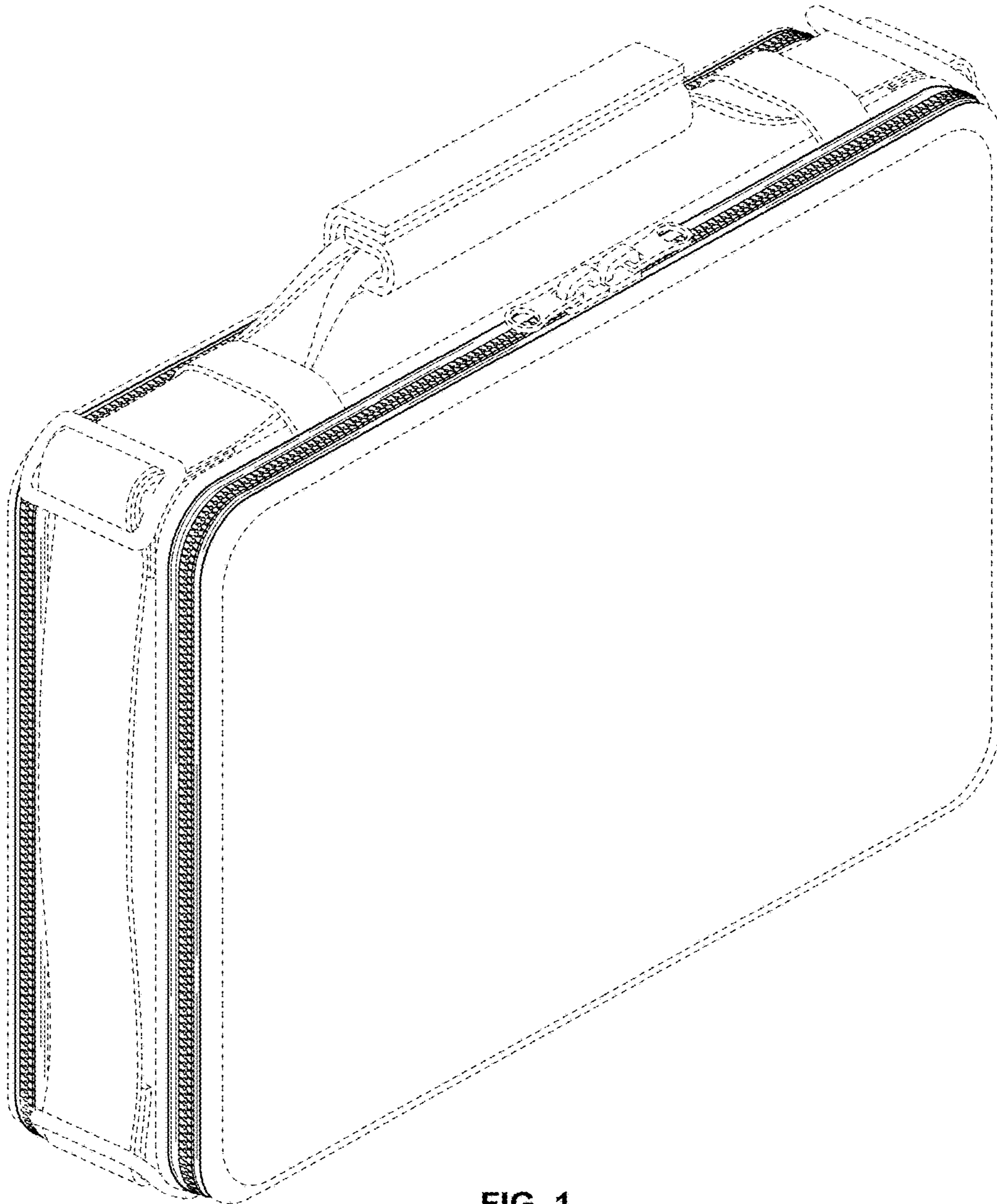

FIG. 1

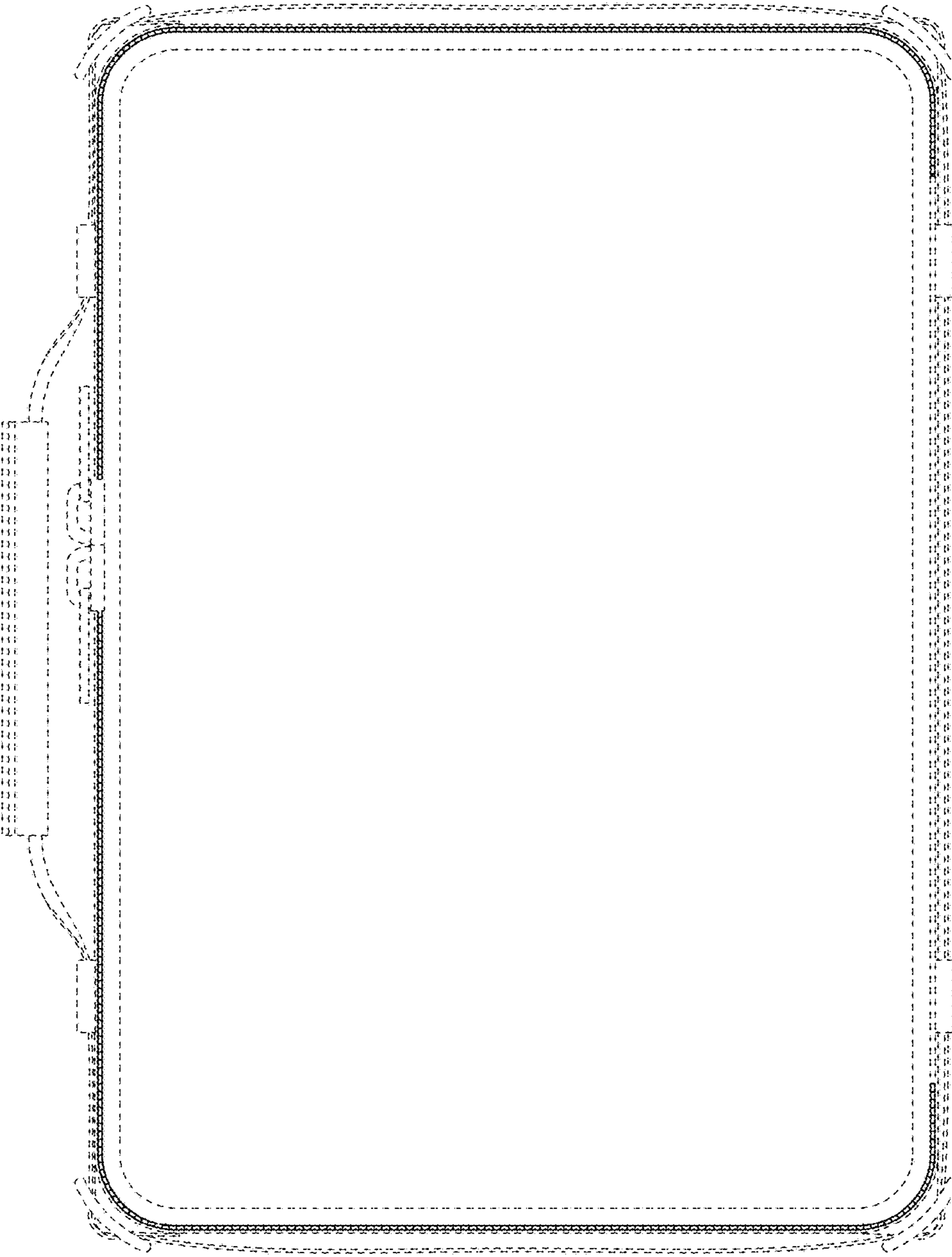

FIG. 2

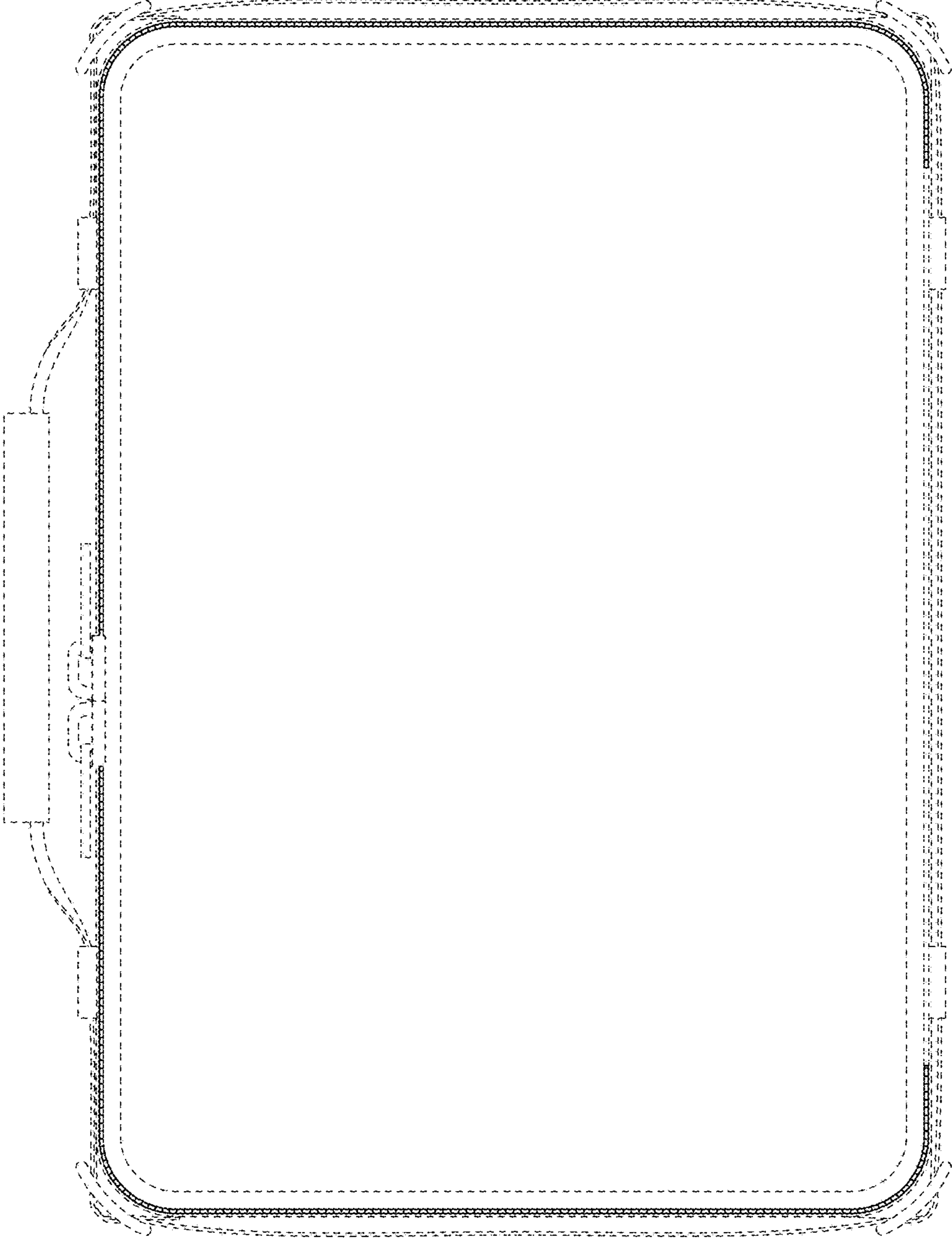

FIG. 3

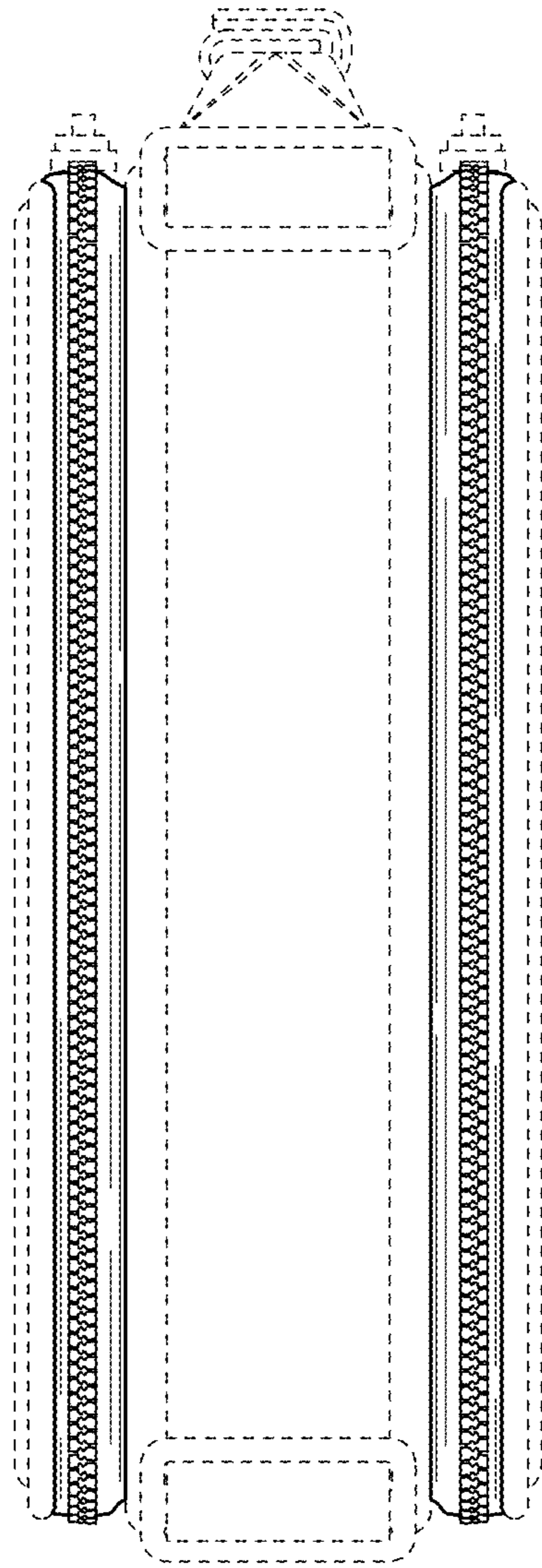

FIG. 4

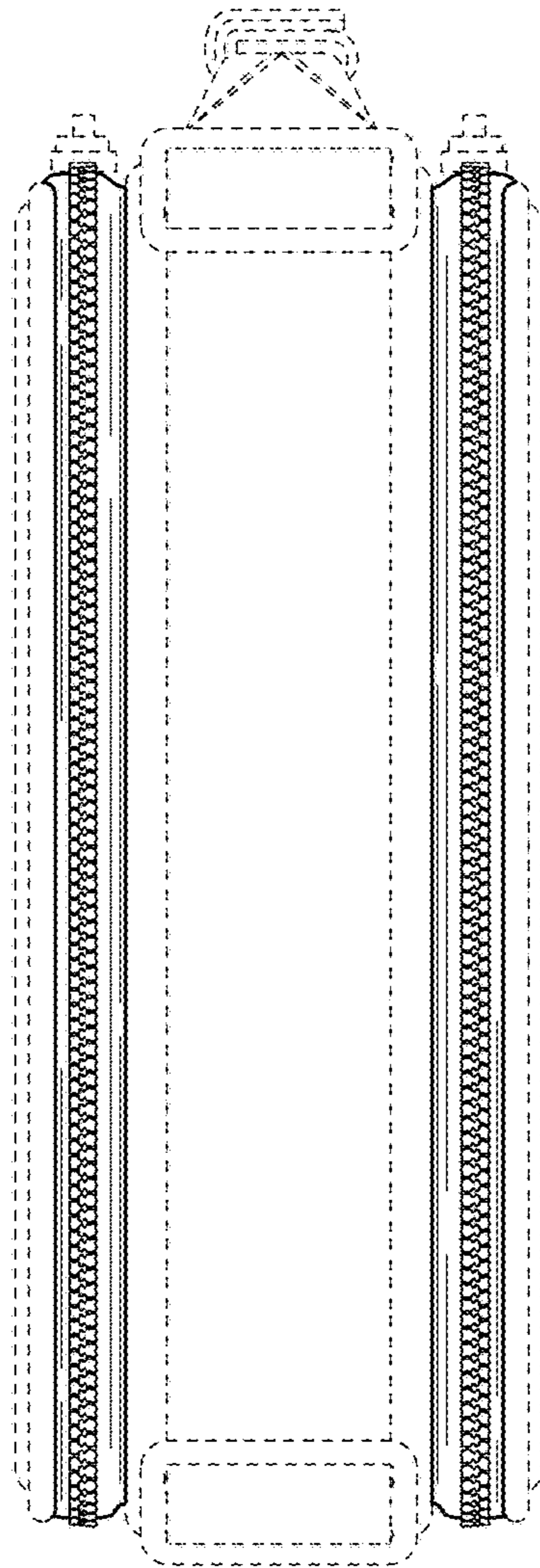

FIG. 5

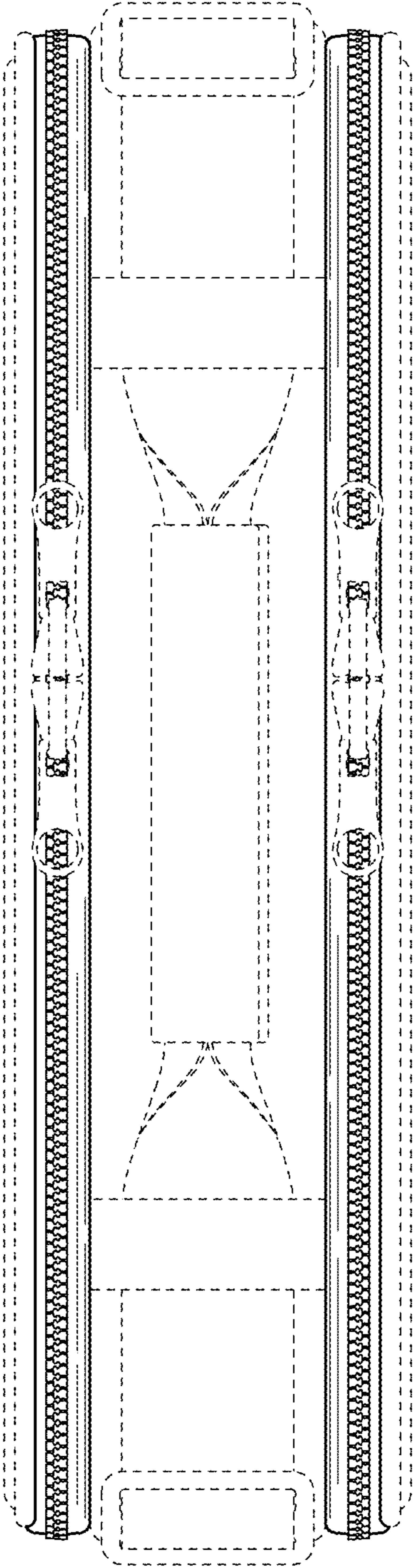

FIG. 6

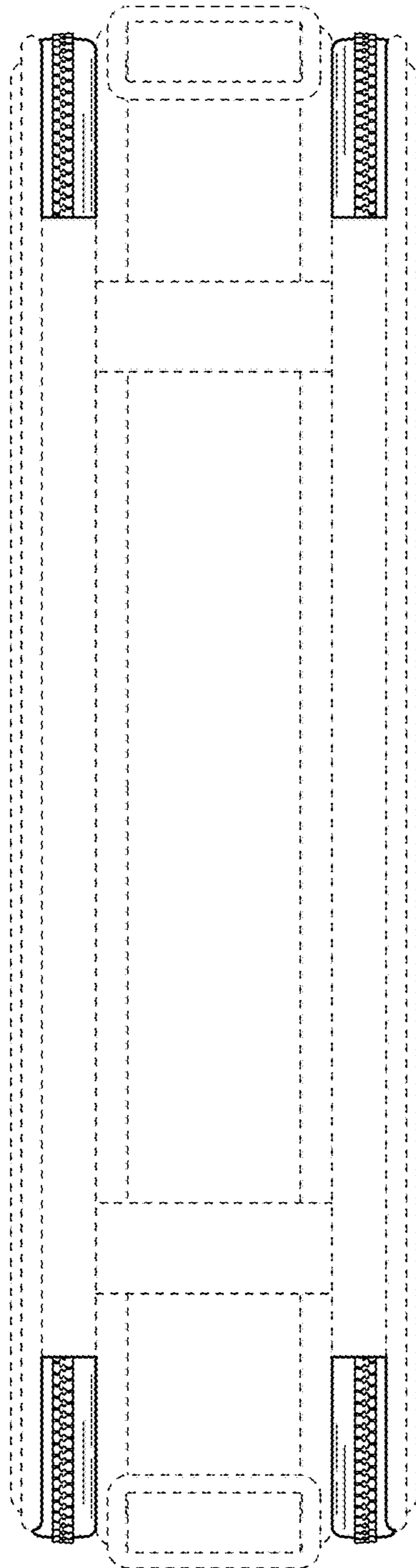

FIG. 7