



US00D776247S

(12) **United States Design Patent**  
**King et al.**

(10) **Patent No.:** **US D776,247 S**

(45) **Date of Patent:** **\*\* Jan. 10, 2017**

(54) **VOLATILE SUBSTANCE DISPENSER**

D672,861 S \* 12/2012 Adair ..... D23/366  
D672,862 S \* 12/2012 Adair ..... D23/366  
D686,718 S \* 7/2013 Gordon ..... D23/366

(71) Applicant: **Reckitt Benckiser (Brands) Limited**,  
Slough, Berkshire (GB)

\* cited by examiner

(72) Inventors: **Stuart King**, Warwick (GB); **David Sanders**, Warwick (GB)

*Primary Examiner* — Sandra Snapp

(73) Assignee: **Reckitt Benckiser (Brands) Limited**,  
Slough, Berkshire (GB)

(74) *Attorney, Agent, or Firm* — Norris McLaughlin & Marcus PA

(\*\*) Term: **15 Years**

(21) Appl. No.: **29/542,885**

(22) Filed: **Oct. 19, 2015**

(57) **CLAIM**

The ornamental design for a volatile substance dispenser, as shown and described.

(30) **Foreign Application Priority Data**

Apr. 27, 2015 (EP) ..... 002690198-0006

**DESCRIPTION**

(51) **LOC (10) Cl.** ..... **28-99**

(52) **U.S. Cl.**  
USPC ..... **D23/366**

(58) **Field of Classification Search**  
USPC ..... D23/355–369; D28/5, 6; 261/DIG. 17,  
261/DIG. 42, DIG. 47, DIG. 55, DIG. 65,  
261/DIG. 70, DIG. 88, DIG. 89; 392/386,  
392/389, 394, 395, 403; 239/34, 44, 45,  
239/53, 56  
CPC ..... A61L 9/02; A61L 9/03; A61L 9/034;  
A61L 9/04; A61L 9/12; A61L  
9/032; A61L 9/122; A61L 9/127; A61L  
9/22  
See application file for complete search history.

FIG. 1 is a perspective view of front the volatile substance dispenser;  
FIG. 2 is an elevation view from the front of the volatile substance dispenser;  
FIG. 3 is an elevation view from the back of the volatile substance dispenser;  
FIG. 4 is an elevation view from the side of the volatile substance dispenser;  
FIG. 5 is an elevation view from the opposite side of the volatile substance dispenser;  
FIG. 6 is a plan view of the top of the volatile substance dispenser; and,  
FIG. 7 is a plan view of the bottom of the volatile substance dispenser.  
The broken lines showing of parts of the volatile substance dispenser shown in broken lines are for illustrative purposes only and form no part of the claimed design.

(56) **References Cited**

**U.S. PATENT DOCUMENTS**

D507,636 S \* 7/2005 Baraky ..... D23/366  
D624,170 S \* 9/2010 Myojin ..... D23/366  
D659,818 S \* 5/2012 Belongia ..... D23/366

**1 Claim, 7 Drawing Sheets**

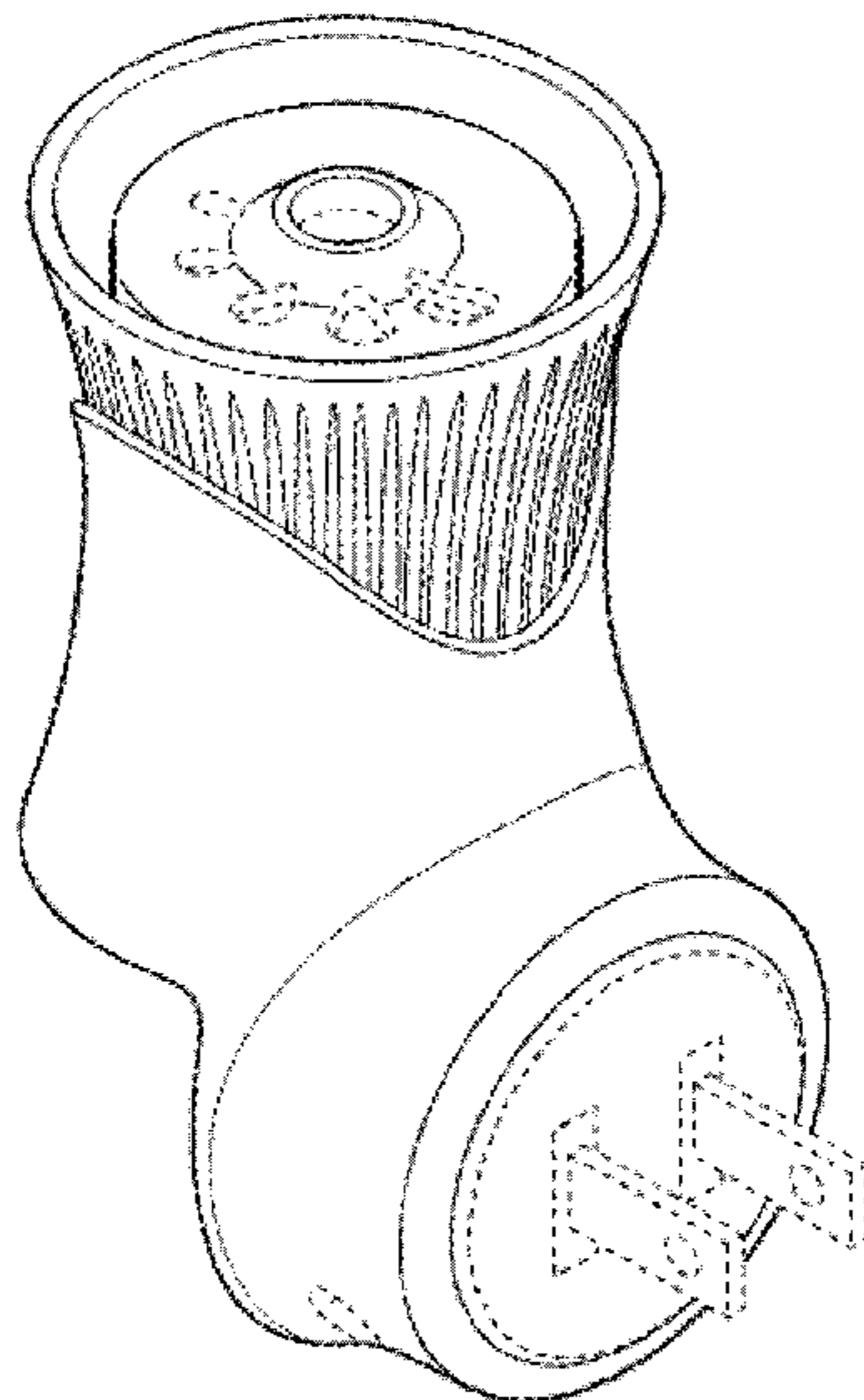

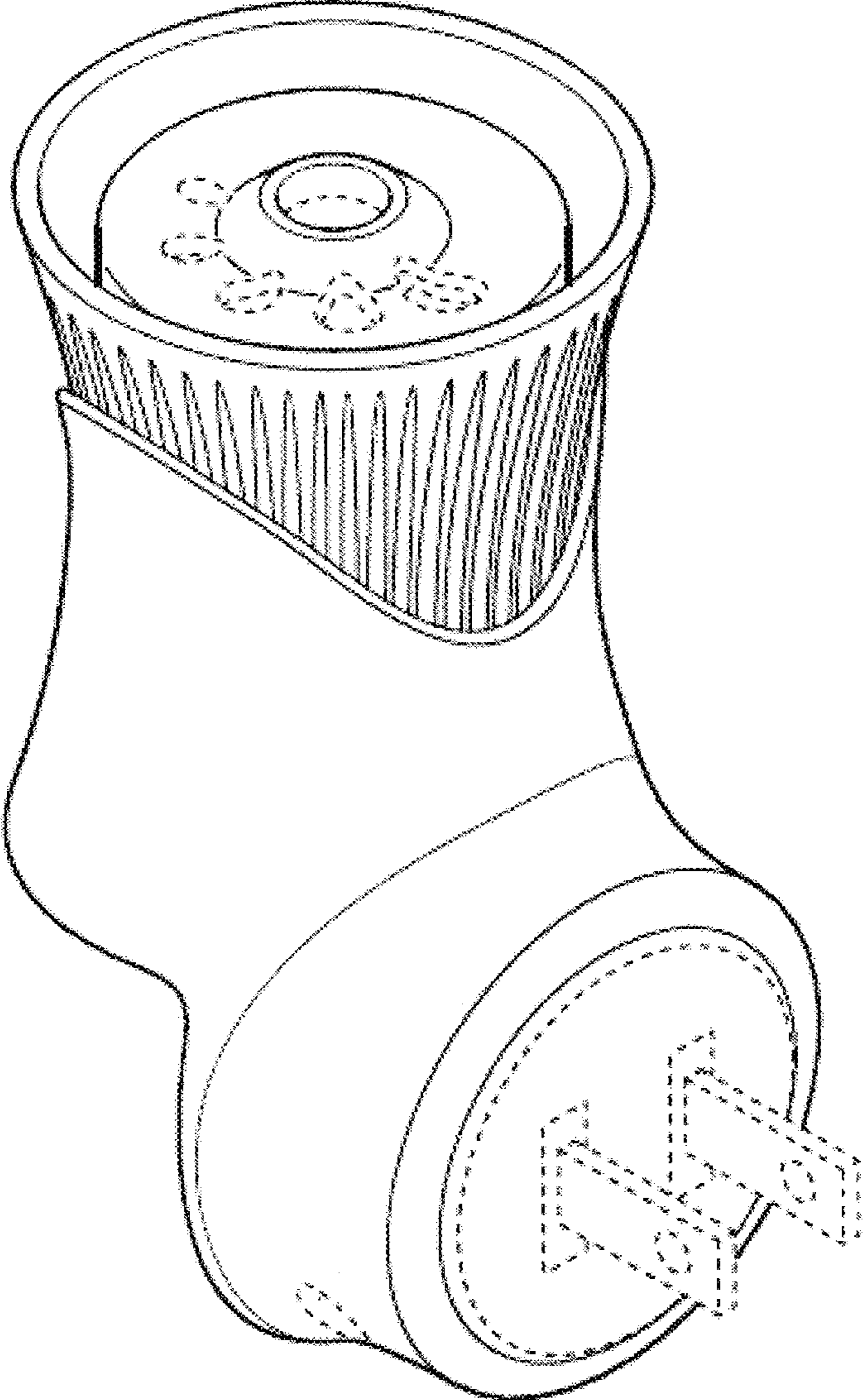
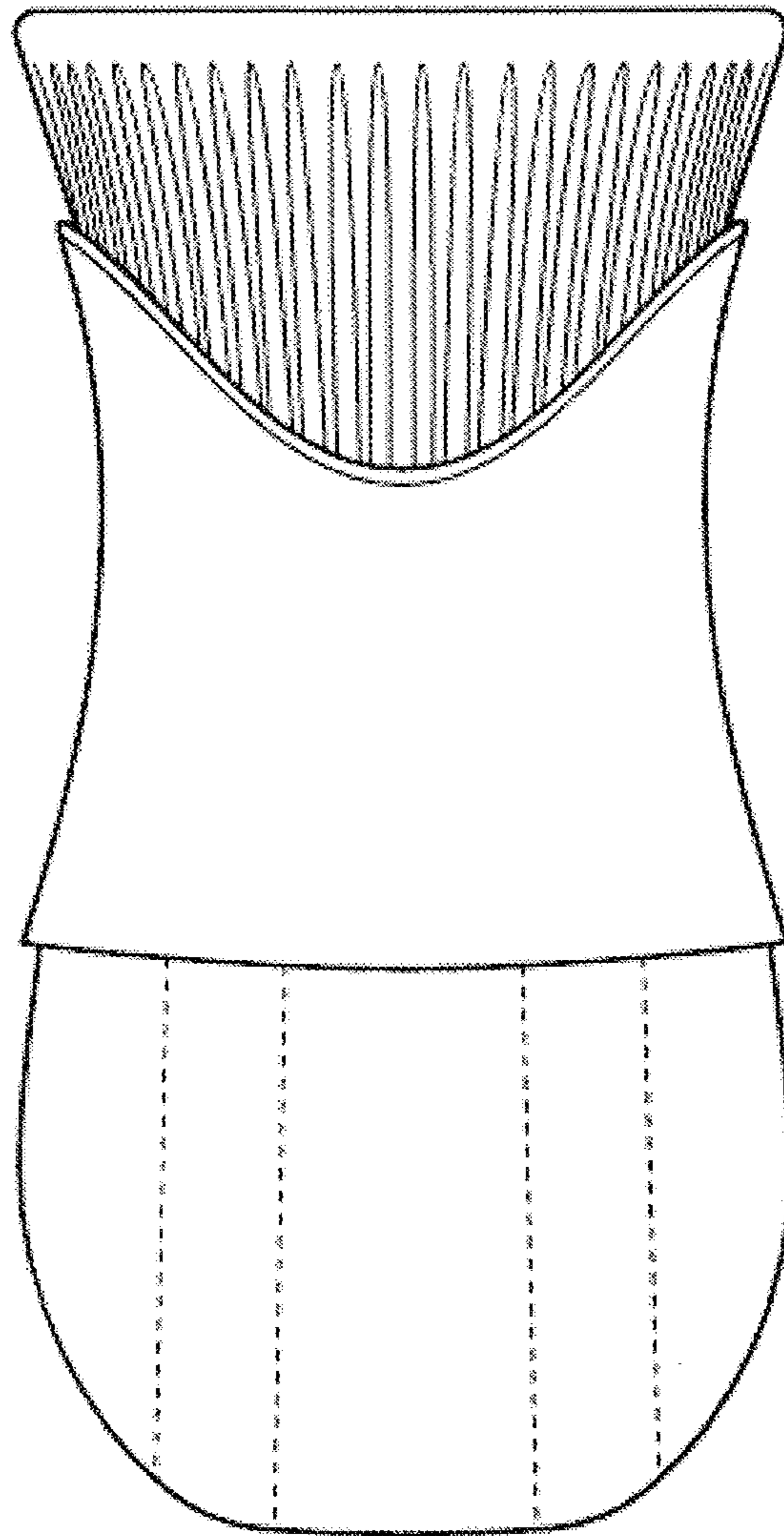
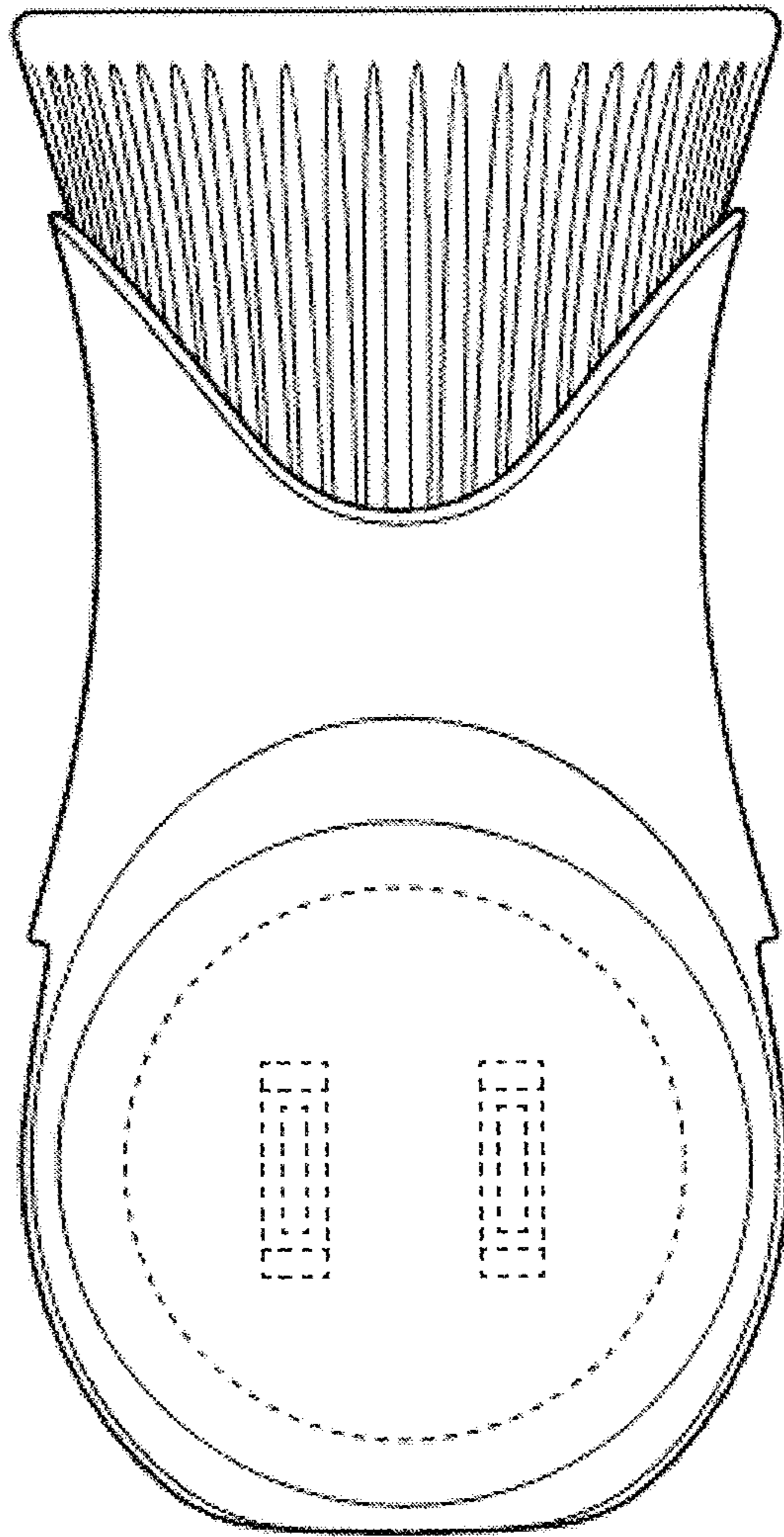

Fig. 1



*Fig. 2*



*Fig. 3*

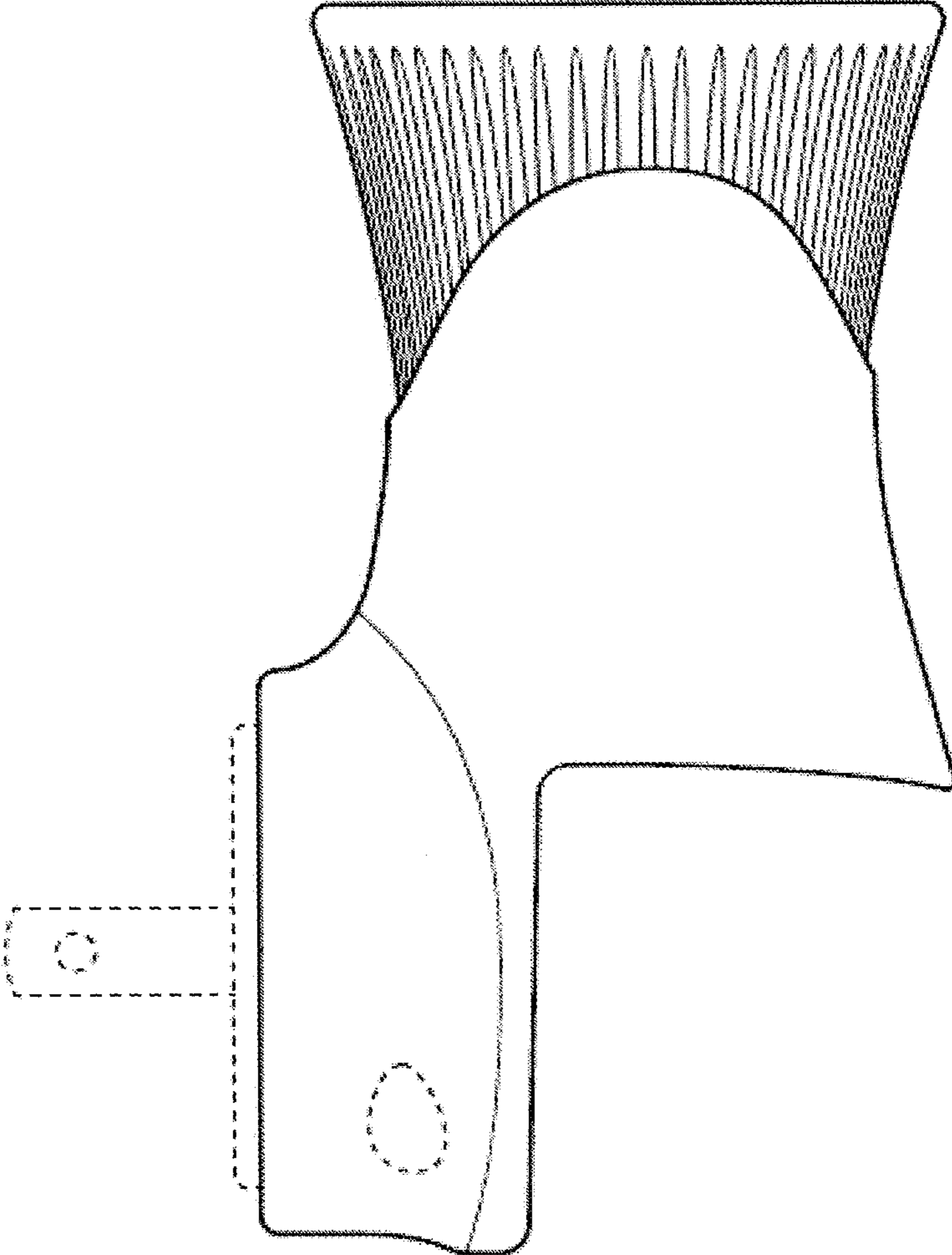

Fig. 4

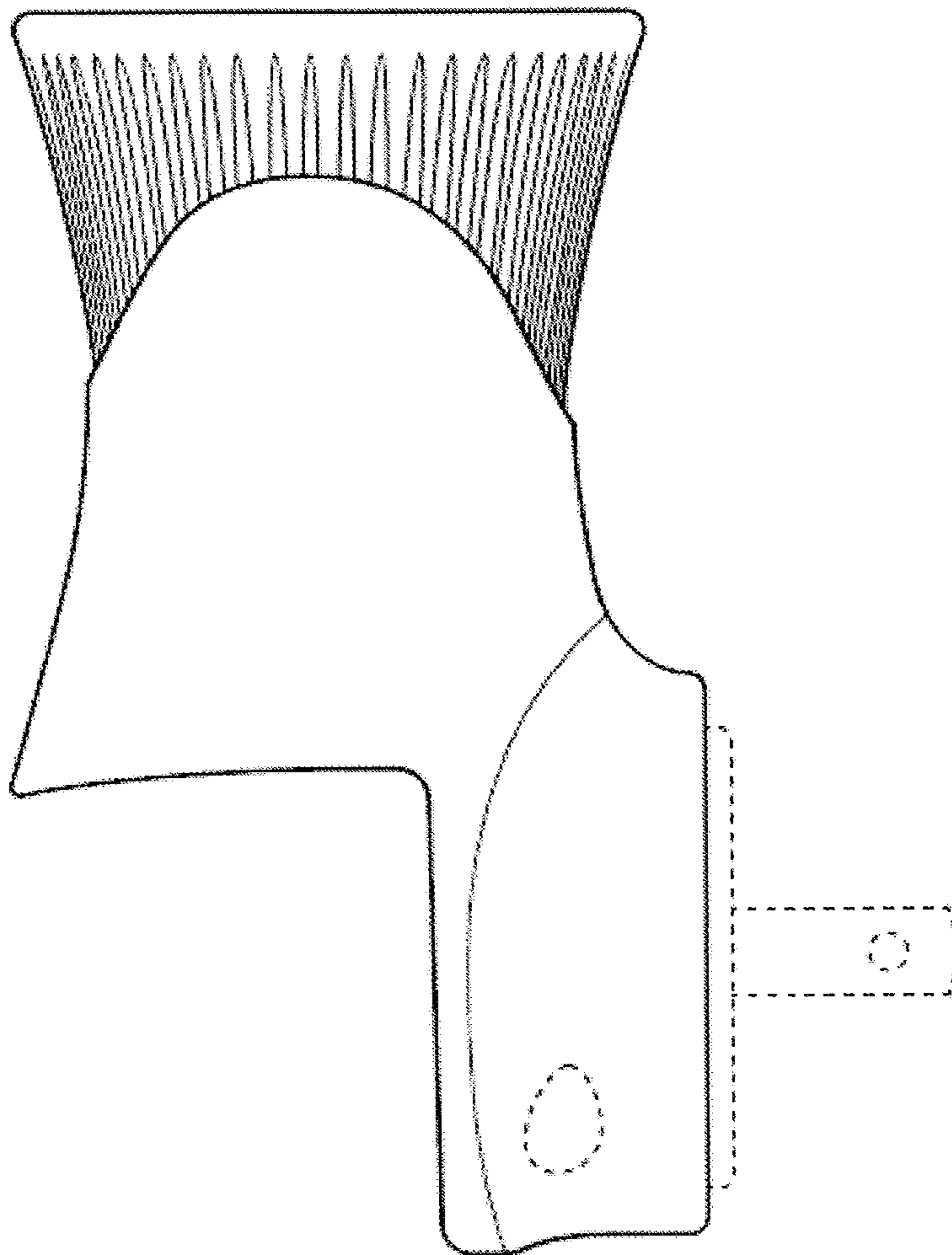
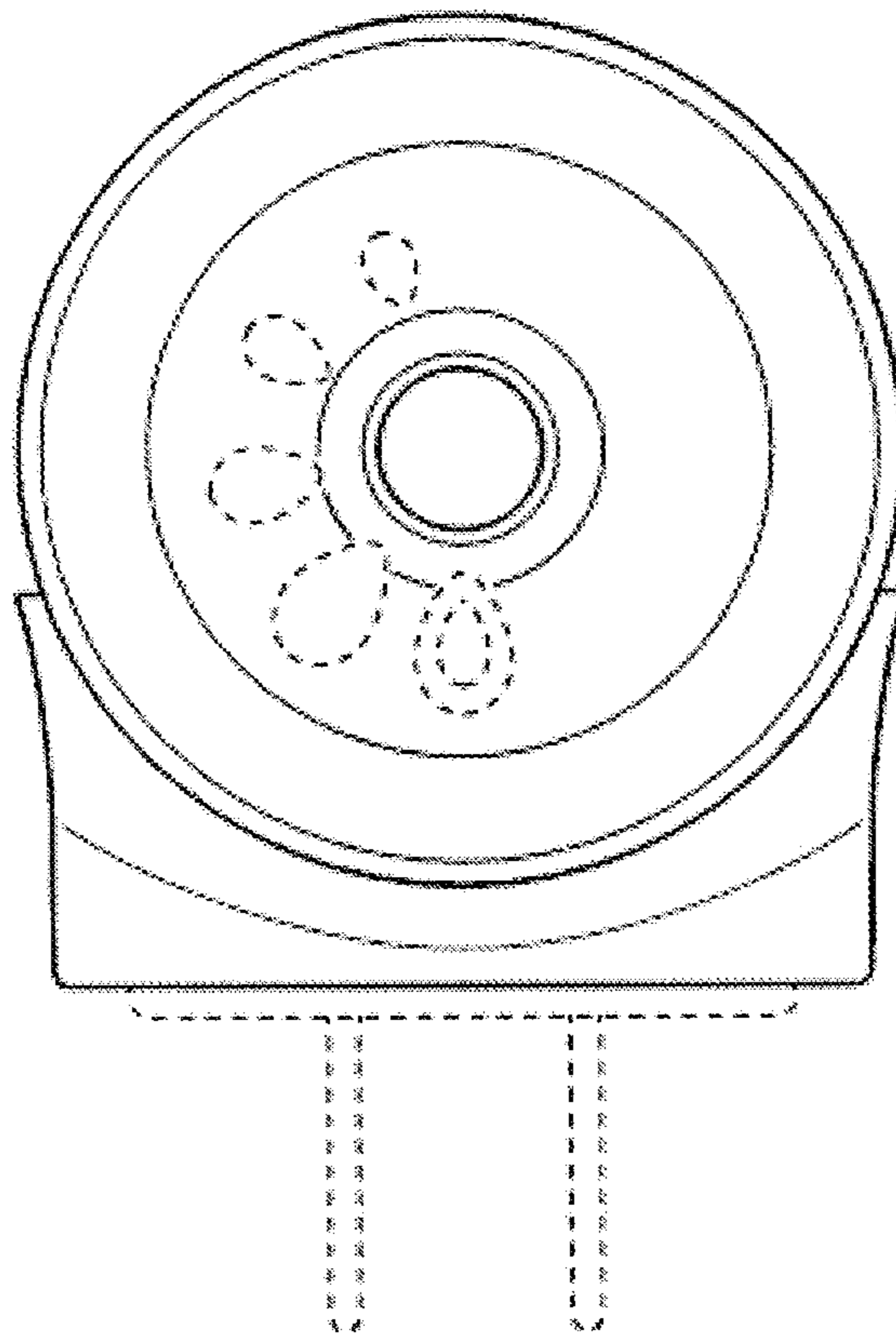

Fig. 5



*Fig. 6*

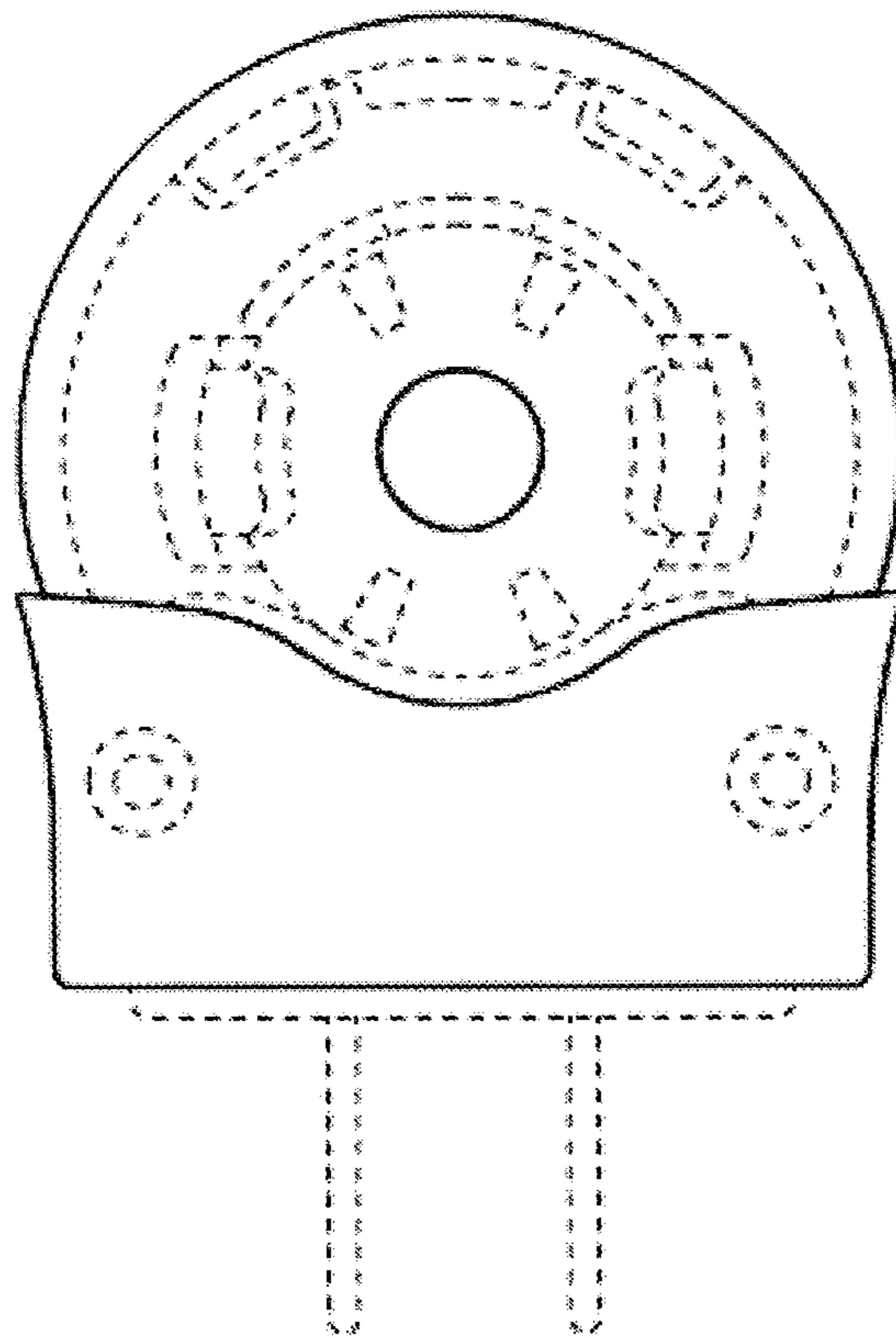

Fig. 7