



US00D776234S

(12) **United States Design Patent**  
**Danos et al.**

(10) **Patent No.:** **US D776,234 S**  
(45) **Date of Patent:** **\*\* Jan. 10, 2017**

(54) **AQUATIC ANIMAL ATTRACTING FLOAT DEVICE**

**DESCRIPTION**

- (71) Applicants: **Jeffrey A. Danos**, Mandeville, LA (US); **Jack A. Danos**, Mandeville, LA (US)
- (72) Inventors: **Jeffrey A. Danos**, Mandeville, LA (US); **Jack A. Danos**, Mandeville, LA (US)
- (\*\*) Term: **15 Years**
- (21) Appl. No.: **29/535,023**
- (22) Filed: **Aug. 3, 2015**
- (51) **LOC (10) Cl.** ..... **22-05**
- (52) **U.S. Cl.**  
USPC ..... **D22/146; D22/126**
- (58) **Field of Classification Search**  
USPC ..... D21/473, 474, 803; D22/121, 125, 126, D22/136, 137, 146; D32/29, 37, 53  
(Continued)

(56) **References Cited**

**U.S. PATENT DOCUMENTS**

- 2,534,709 A \* 12/1950 Goertzen ..... A01K 75/02  
362/203
- 2,614,358 A \* 10/1952 Adams ..... A01K 97/02  
43/43.1

(Continued)

*Primary Examiner* — Manpreet Matharu

*Assistant Examiner* — Suzanne Tisdell

(74) *Attorney, Agent, or Firm* — Asgaard Patent Services, LLC; F. Wayne Thompson, Jr.

(57) **CLAIM**

The ornamental design for an aquatic animal attracting float device, as shown and described.

FIG. 1 is a first embodiment of a top, front, right isometric view of an aquatic animal attracting float device;  
 FIG. 2 is a first embodiment of a front view of an aquatic animal attracting float device;  
 FIG. 3 is a first embodiment of a right side view of an aquatic animal attracting float device;  
 FIG. 4 is a first embodiment of a rear view of an aquatic animal attracting float device;  
 FIG. 5 is a first embodiment of a left side view of an aquatic animal attracting float device;  
 FIG. 6 is a first embodiment of a top view of an aquatic animal attracting float device;  
 FIG. 7 is a first embodiment of a bottom view of an aquatic animal attracting float device;  
 FIG. 8 is a first embodiment of a bottom, front, right isometric view of an aquatic animal attracting float device;  
 FIG. 9 is a second embodiment of a top, front, right isometric view of an aquatic animal attracting float device;  
 FIG. 10 is a second embodiment of a front view of an aquatic animal attracting float device;  
 FIG. 11 is a second embodiment of a right side view of an aquatic animal attracting float device;  
 FIG. 12 is a second embodiment of a rear view of an aquatic animal attracting float device;  
 FIG. 13 is a second embodiment of a left side view of an aquatic animal attracting float device;  
 FIG. 14 is a second embodiment of a top view of an aquatic animal attracting float device;  
 FIG. 15 is a second embodiment of a bottom view of an aquatic animal attracting float device; and,  
 FIG. 16 is a second embodiment of a bottom, front, right isometric view of an aquatic animal attracting float device.  
 The broken lines shown in the drawings represent portions of the aquatic animal attracting float device that form no part of the claimed design.

**1 Claim, 14 Drawing Sheets**

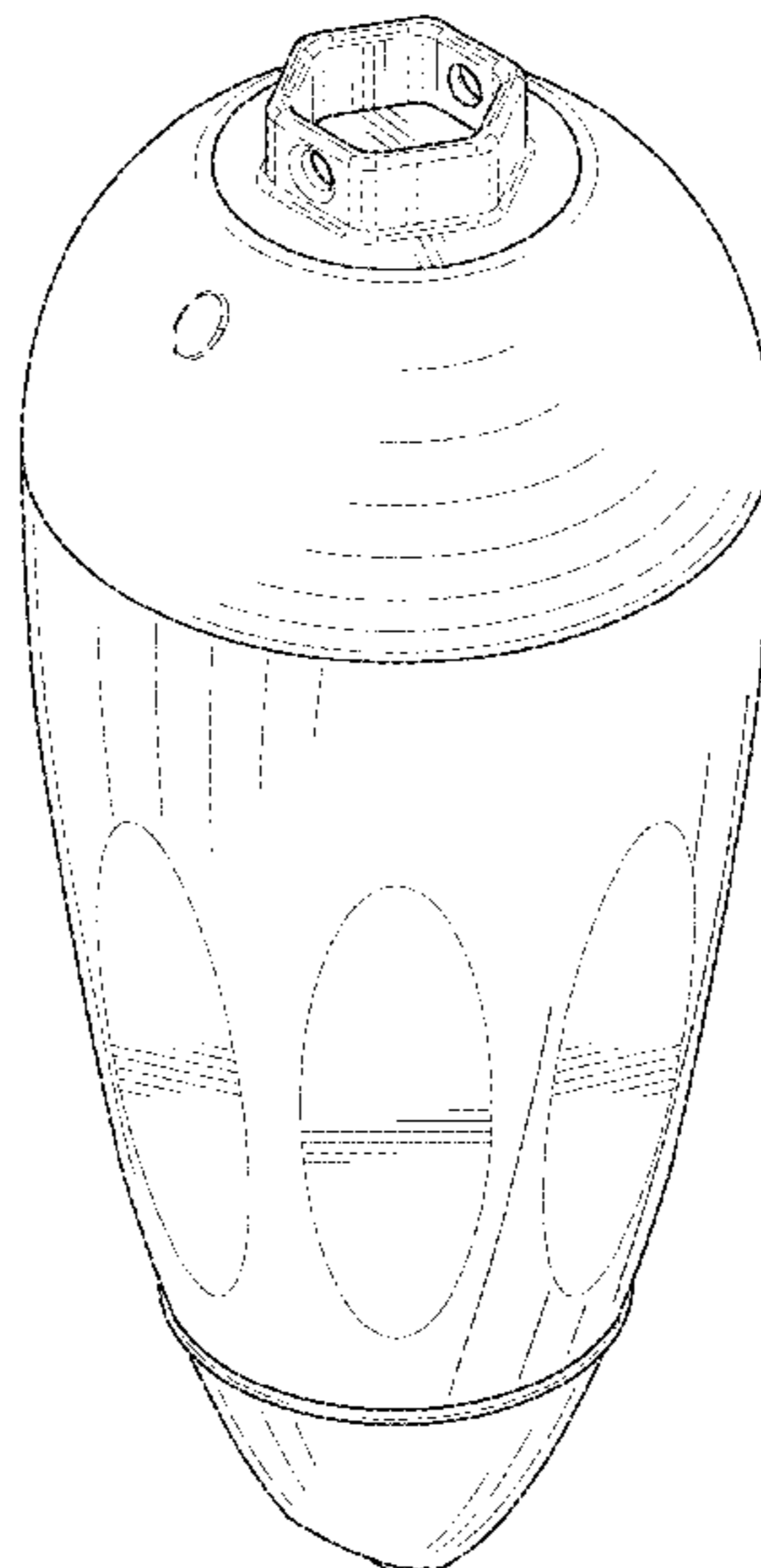

(58) **Field of Classification Search**

CPC ..... A01K 97/00; A01K 97/02; A01K 97/04;  
                   B63B 17/00; A01G 31/02; B65D 25/00;  
   B65G 45/04

See application file for complete search history.

(56) **References Cited**

U.S. PATENT DOCUMENTS

D300,344	S *	3/1989	Boulette, III	.....	D22/126
D302,842	S *	8/1989	Holzman	.....	D22/129
5,031,351	A *	7/1991	Rogel	.....	A01K 95/00 43/43.12
5,331,760	A	7/1994	DuMont		
D442,256	S *	5/2001	Haney	.....	D22/146
D466,582	S *	12/2002	Haney	.....	D22/146
D562,934	S *	2/2008	Haney	.....	D22/146
D616,524	S *	5/2010	Haroian	.....	D22/134
D691,694	S *	10/2013	Marshall	.....	D22/126
D747,434	S *	1/2016	Gibbs	.....	D22/126
2003/0046857	A1 *	3/2003	Paulsen	.....	A01K 95/00 43/42.06
2004/0068916	A1 *	4/2004	Harris	.....	A01K 97/02 43/44.99
2007/0147173	A1 *	6/2007	Park	.....	G01S 7/521 367/107
2007/0180758	A1 *	8/2007	Patton	.....	A01K 91/06 43/44.92
2008/0022579	A1 *	1/2008	Osenbach	.....	A01K 91/02 43/43.1
2008/0236020	A1 *	10/2008	Murrell	.....	A01K 83/06 43/4.5
2013/0049237	A1 *	2/2013	Al-Anzi	.....	A01K 61/02 261/120
2014/0027358	A1 *	1/2014	Sayre	.....	C02F 1/688 210/85

\* cited by examiner

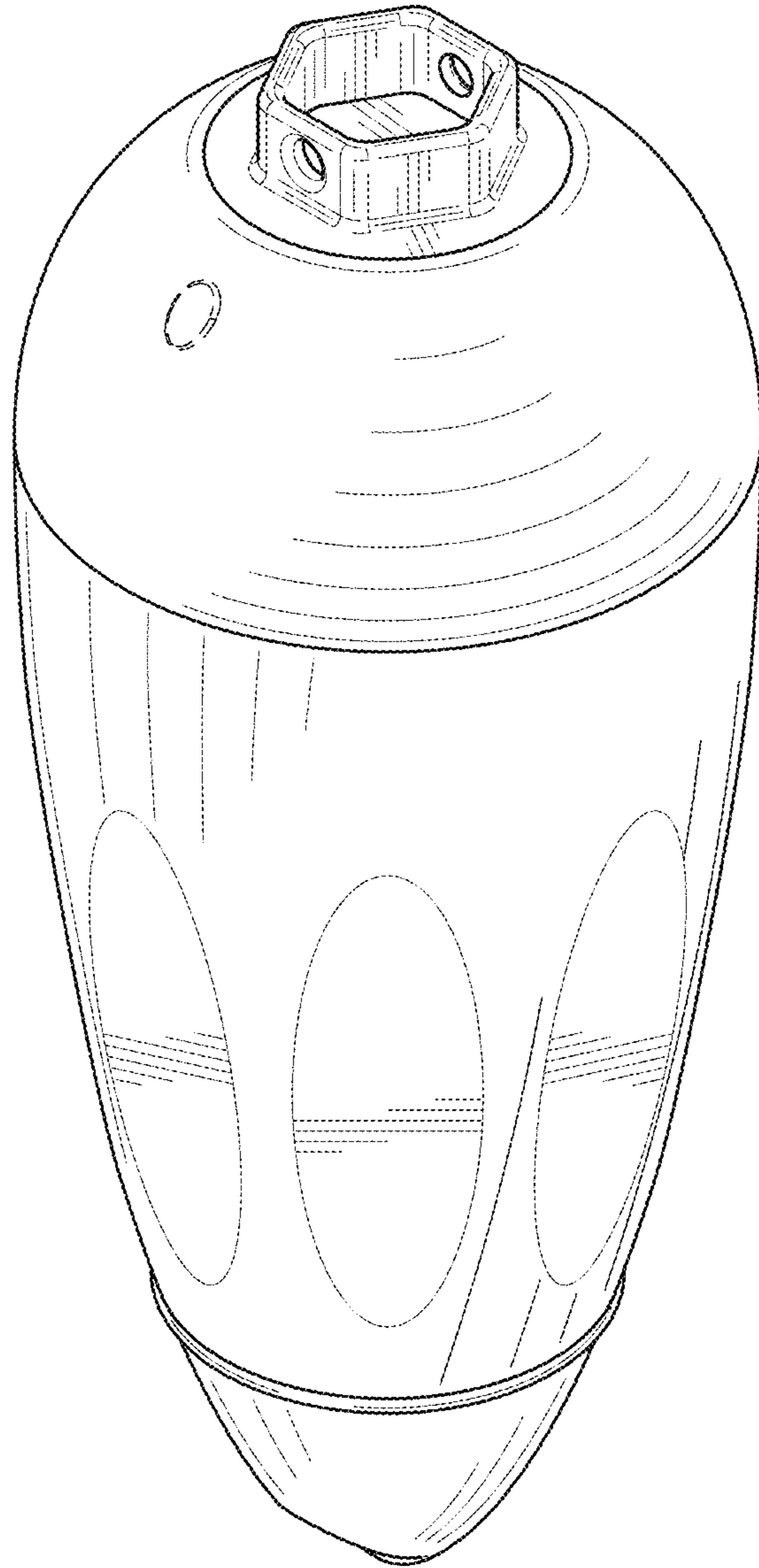

FIG. 1

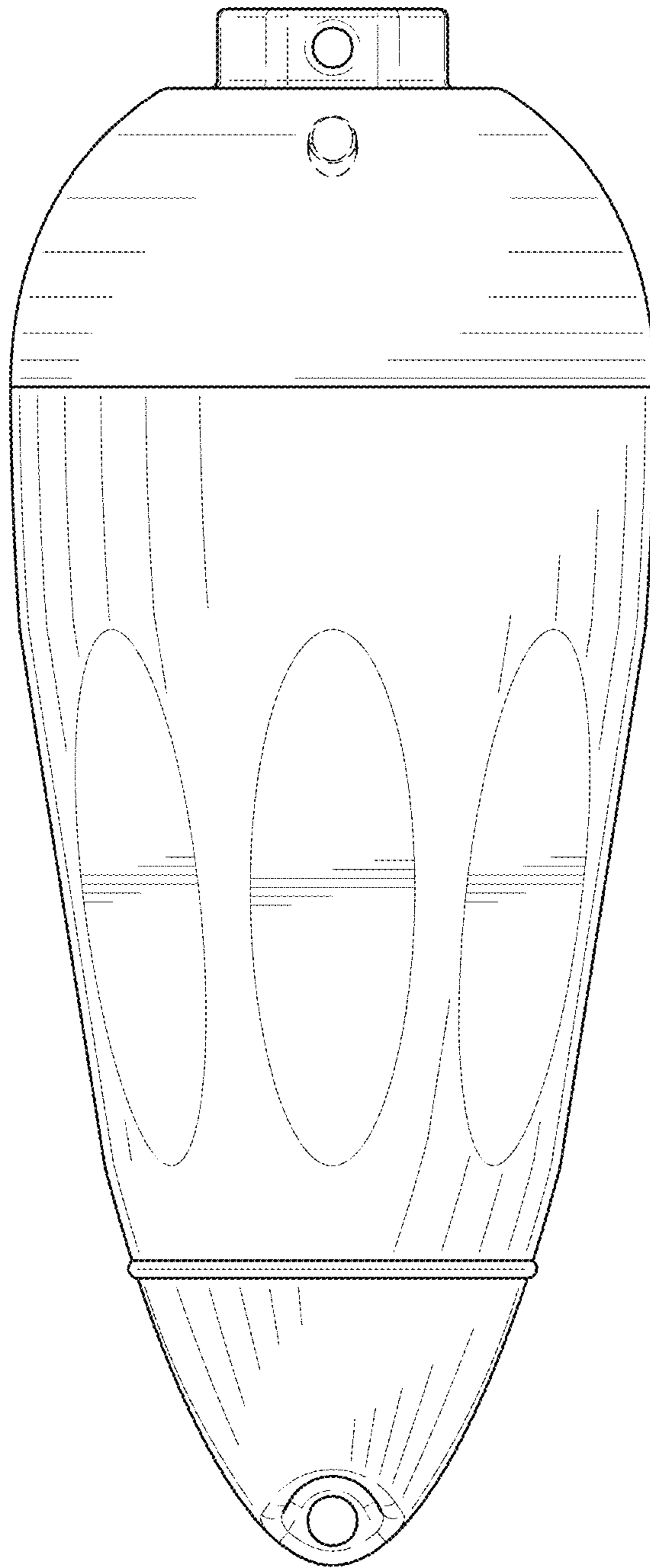

FIG. 2

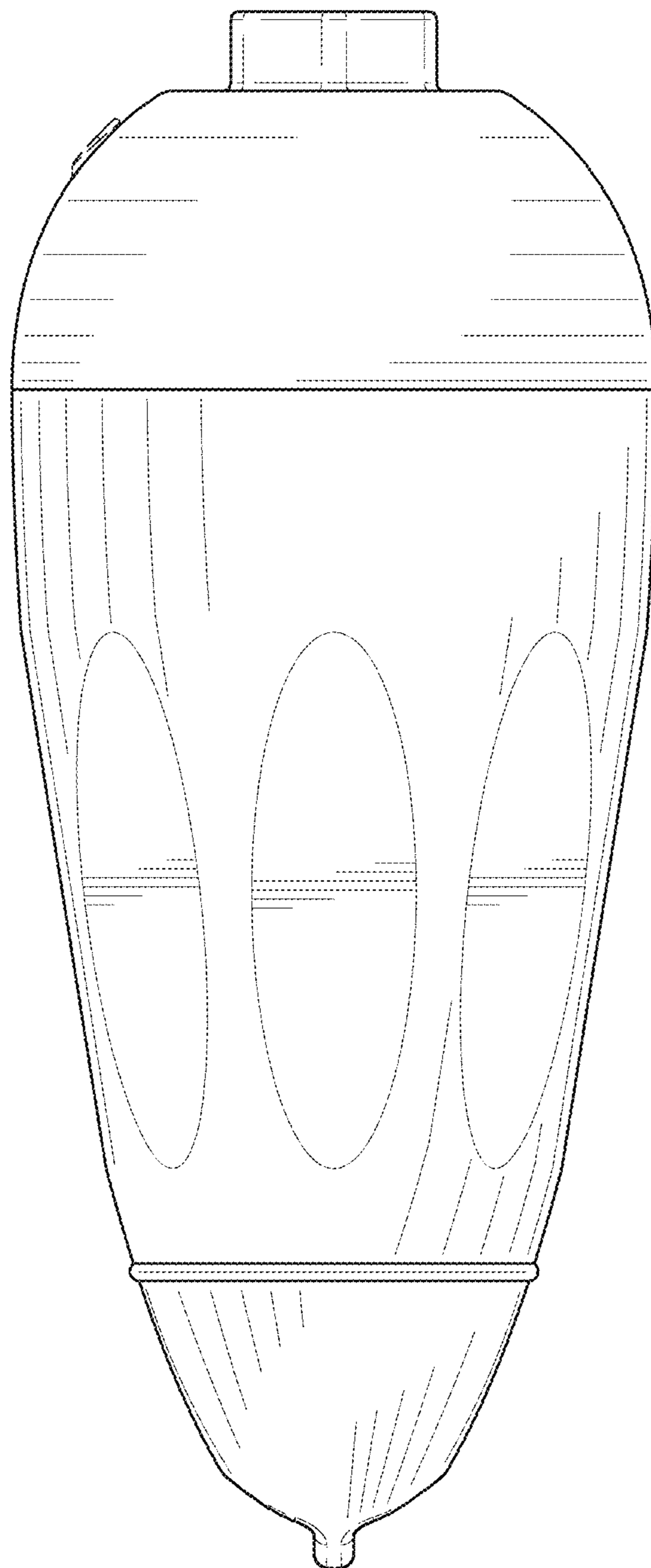

FIG. 3

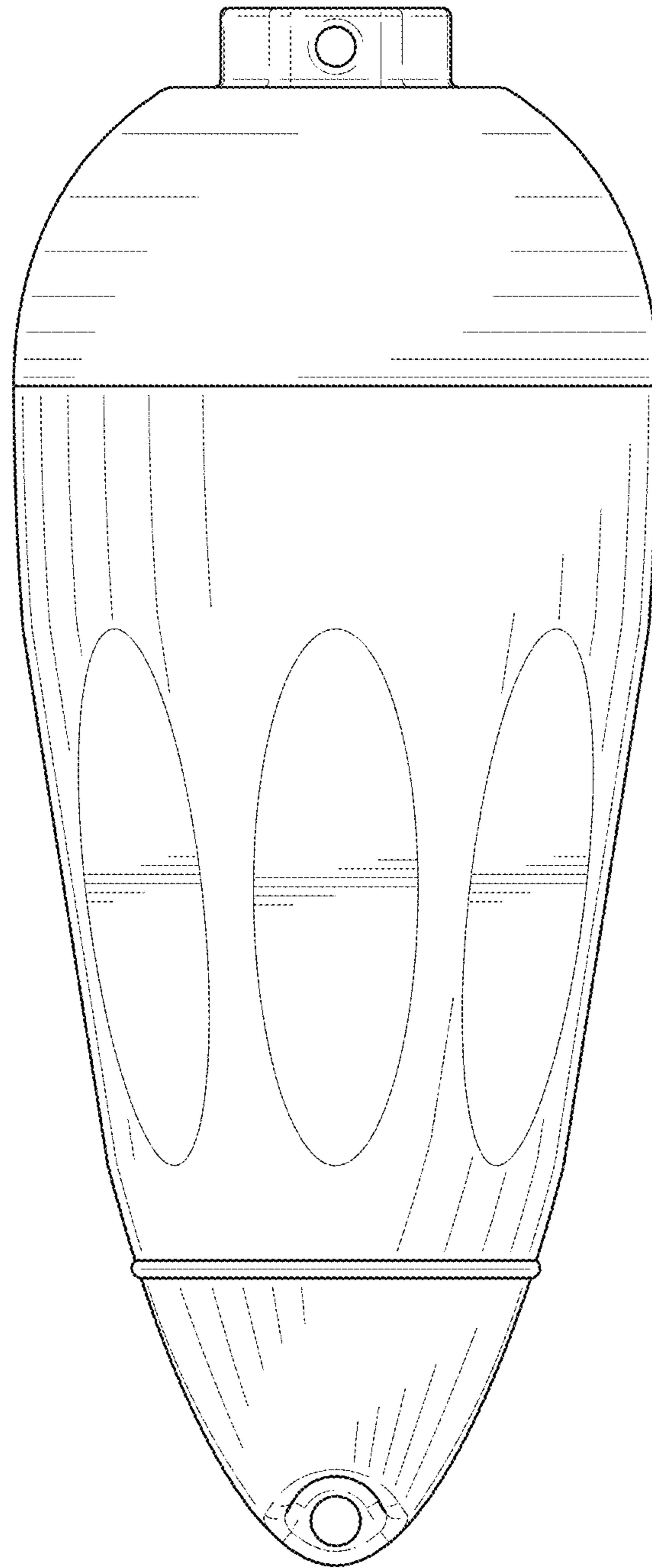

FIG. 4

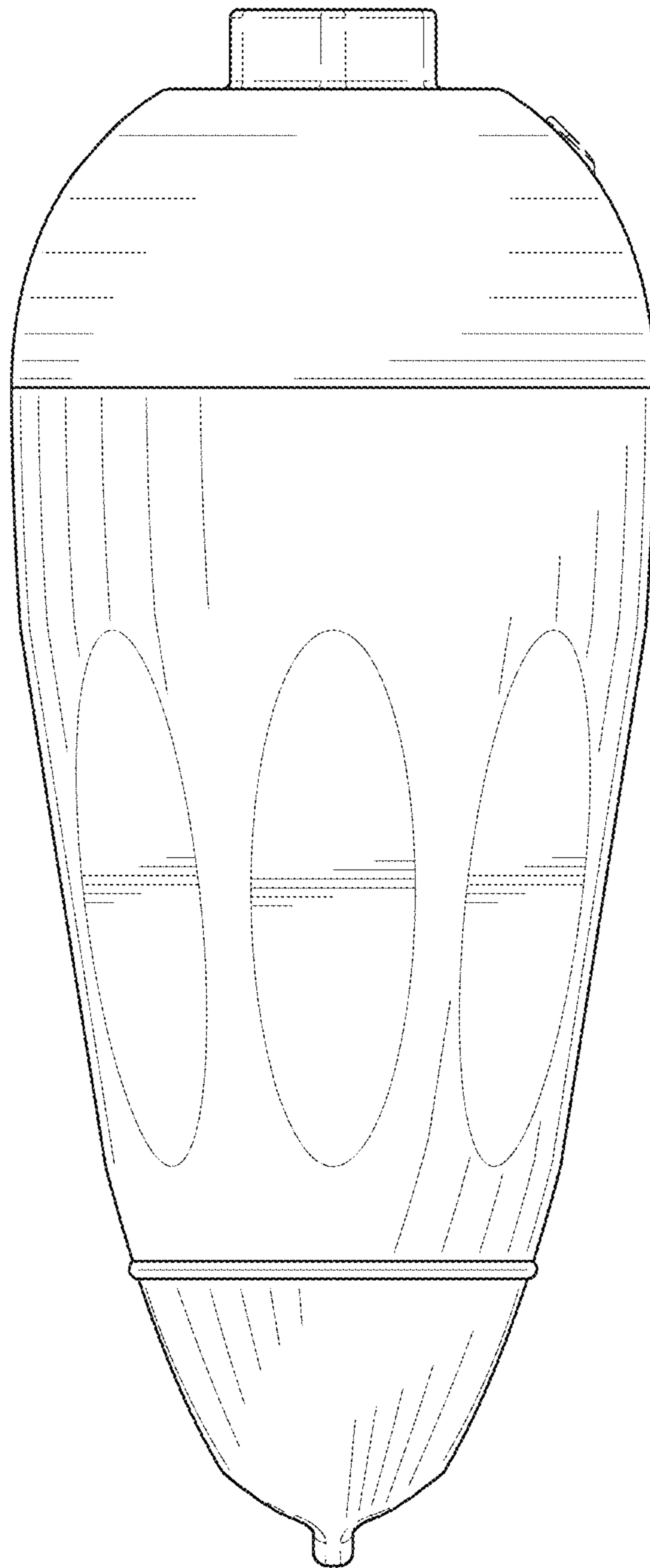

FIG. 5

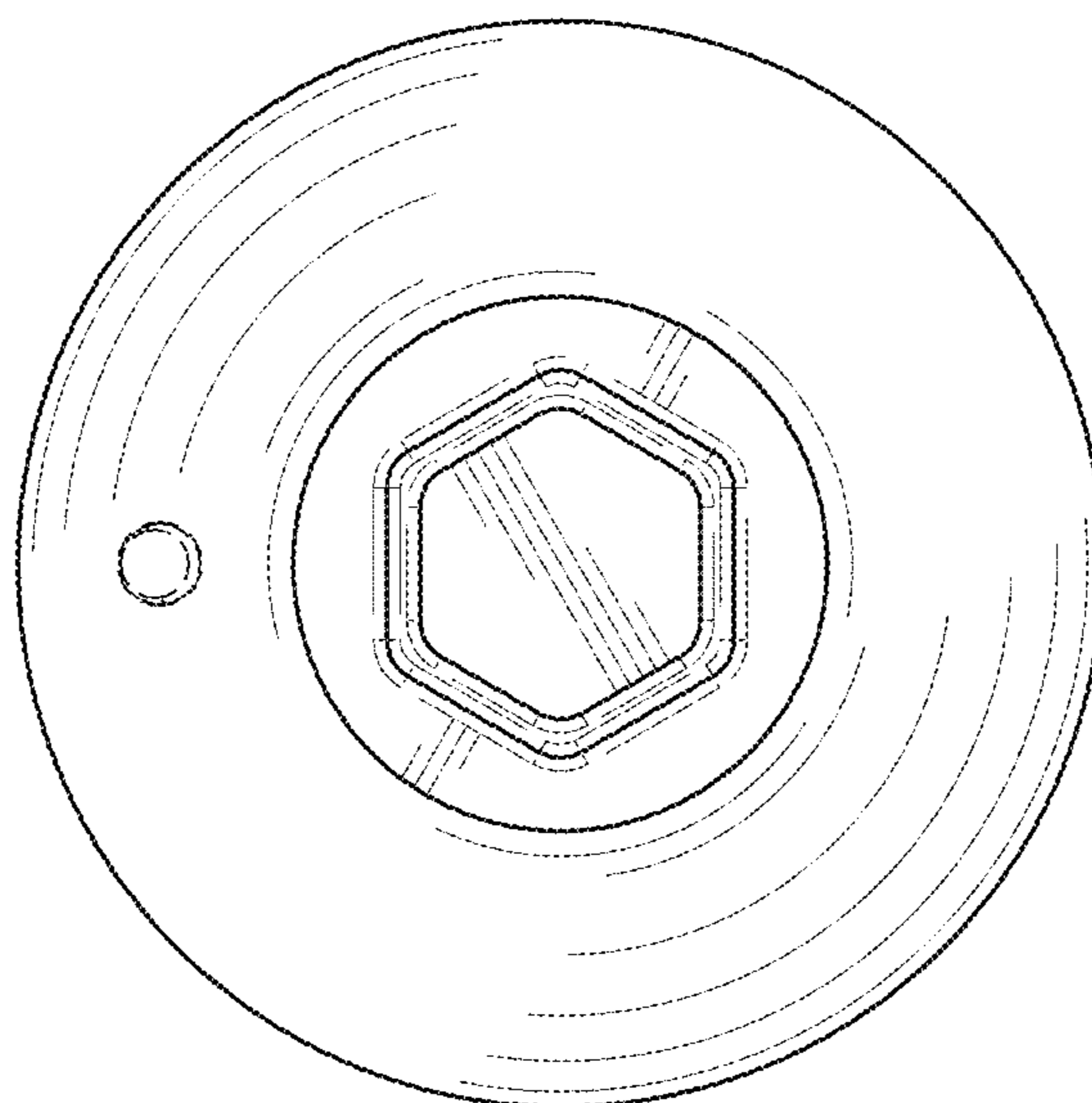

FIG. 6

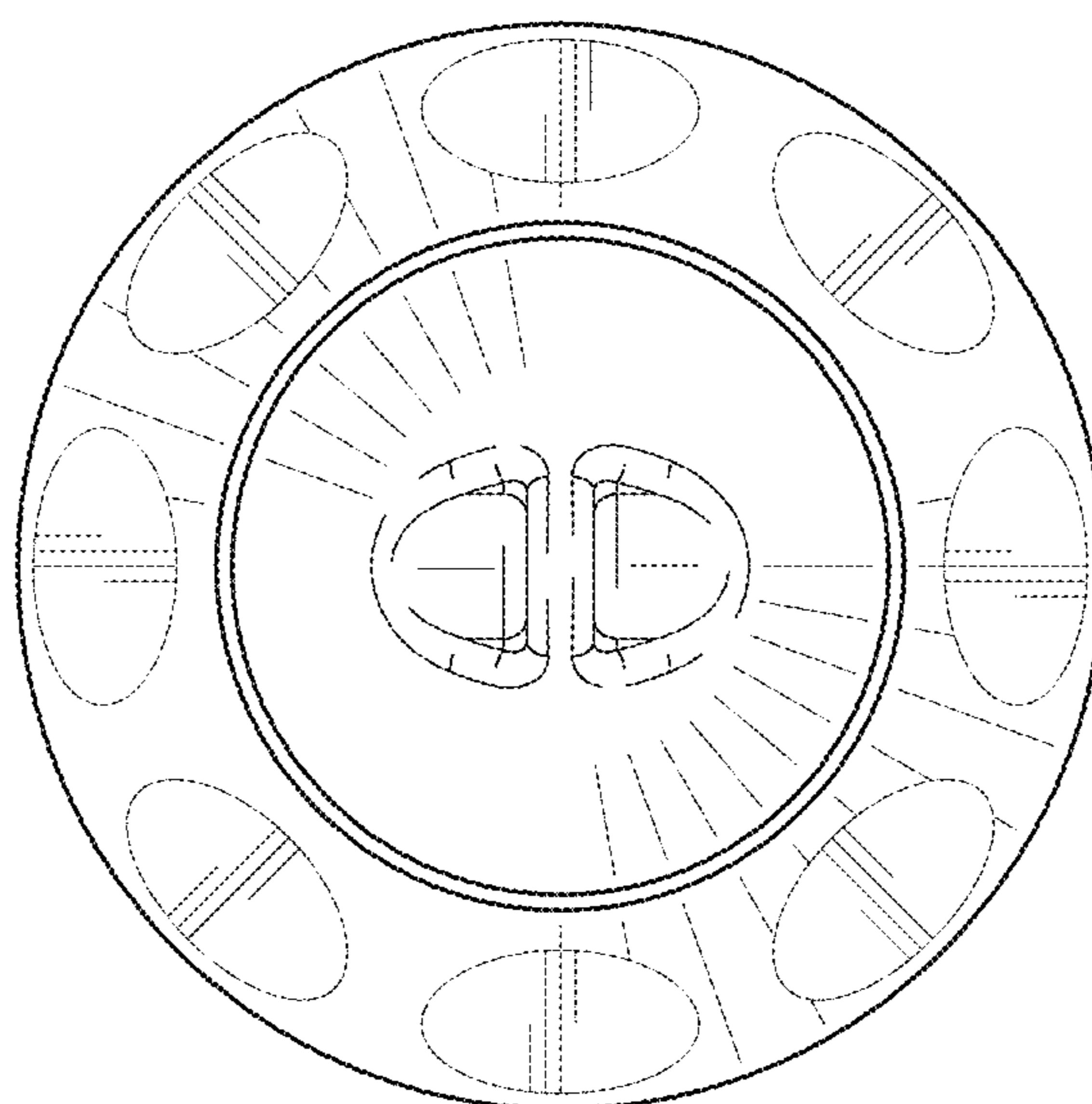

FIG. 7



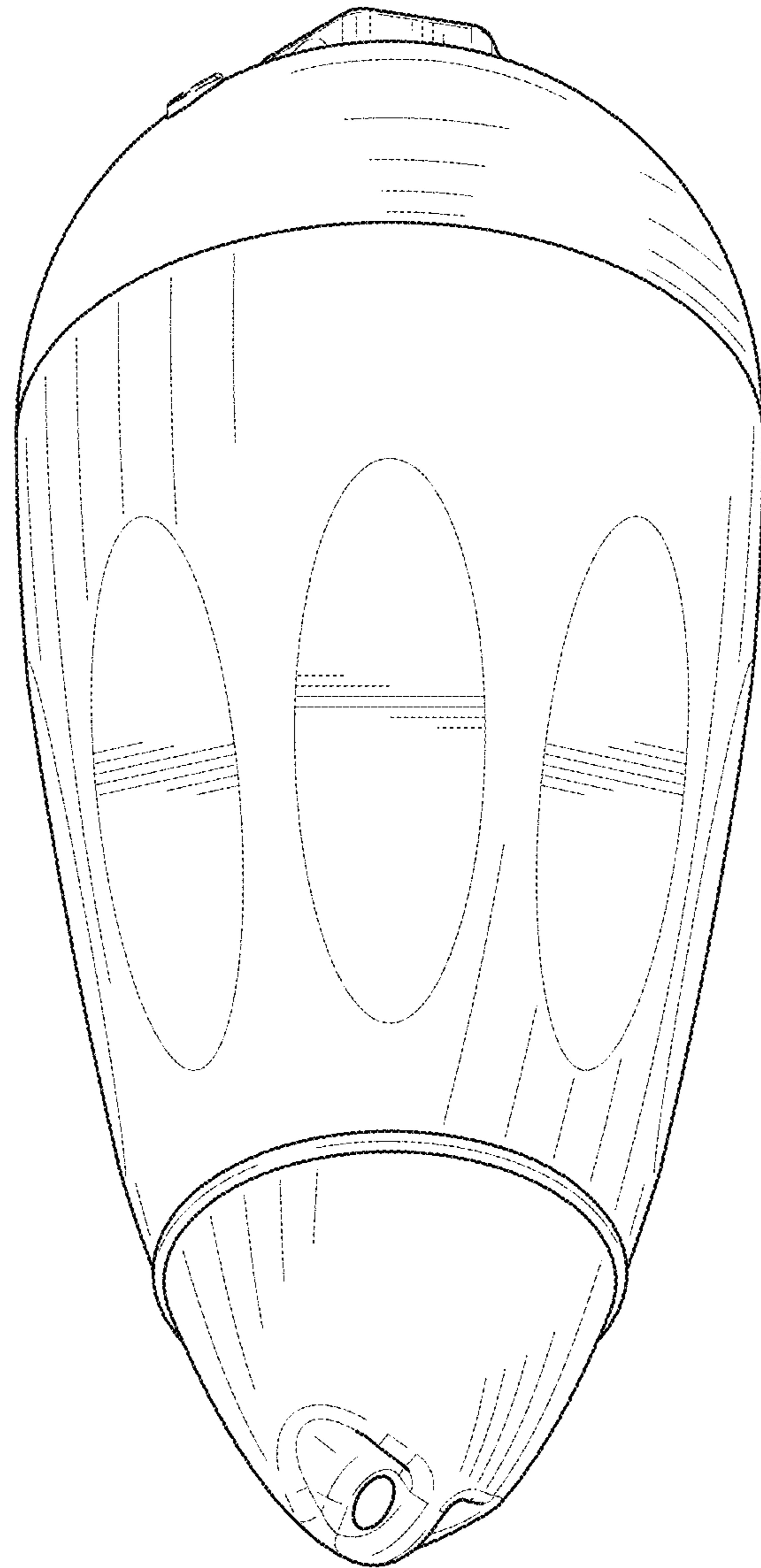

FIG. 8

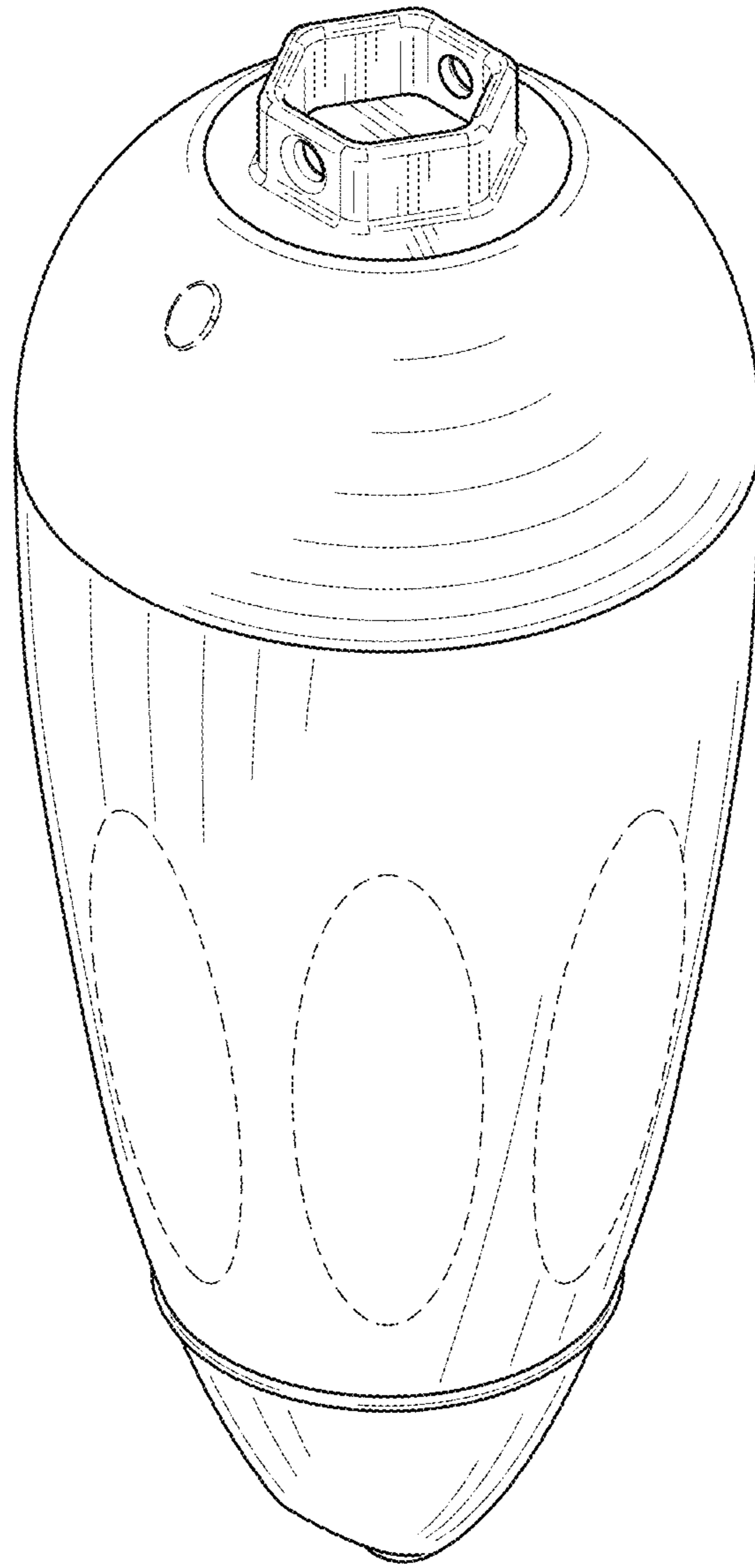

FIG. 9

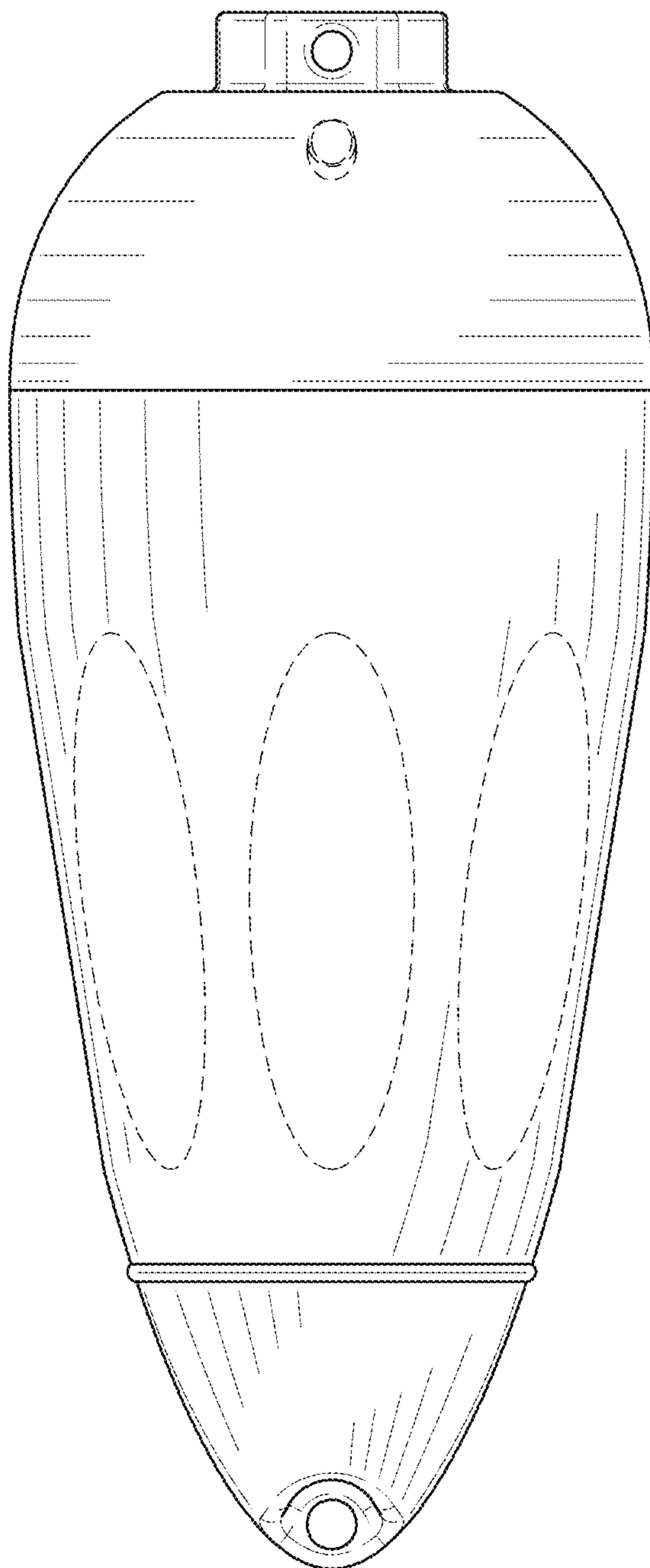

FIG. 10

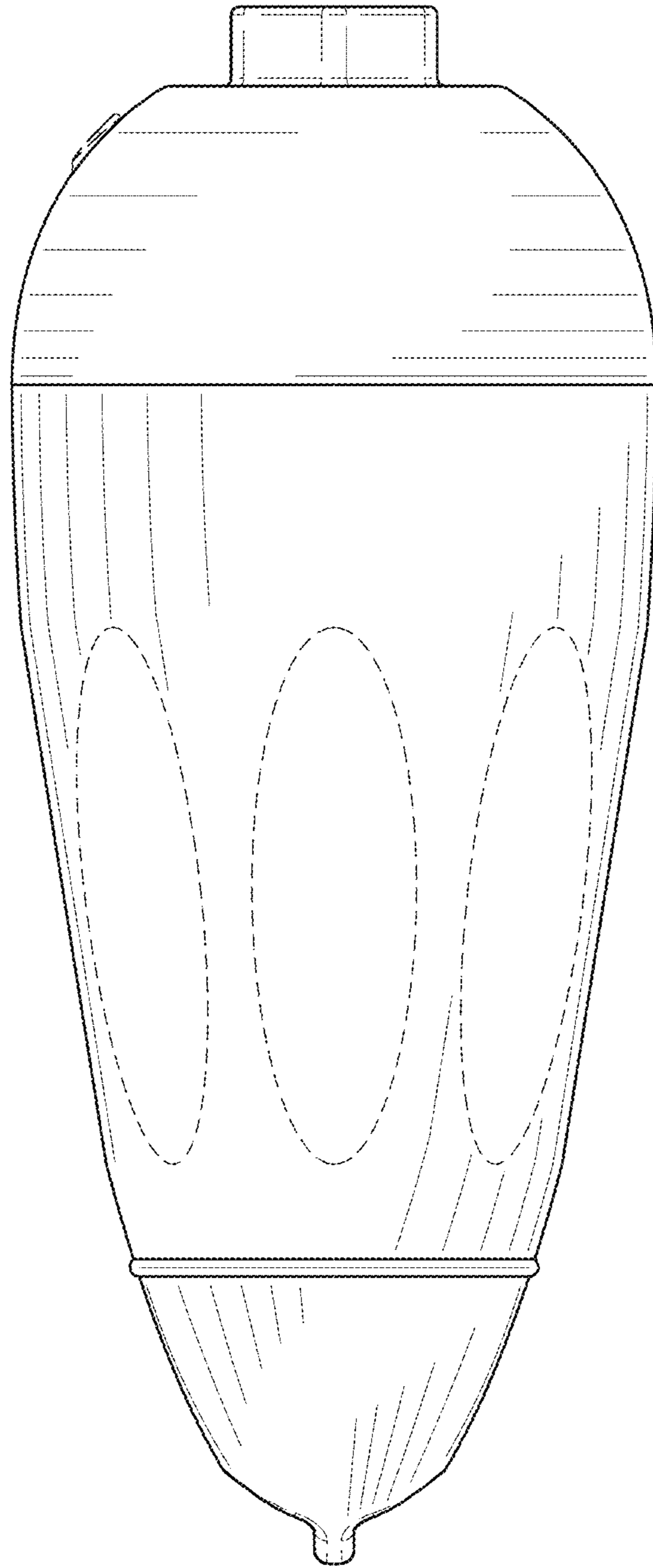

FIG. 11

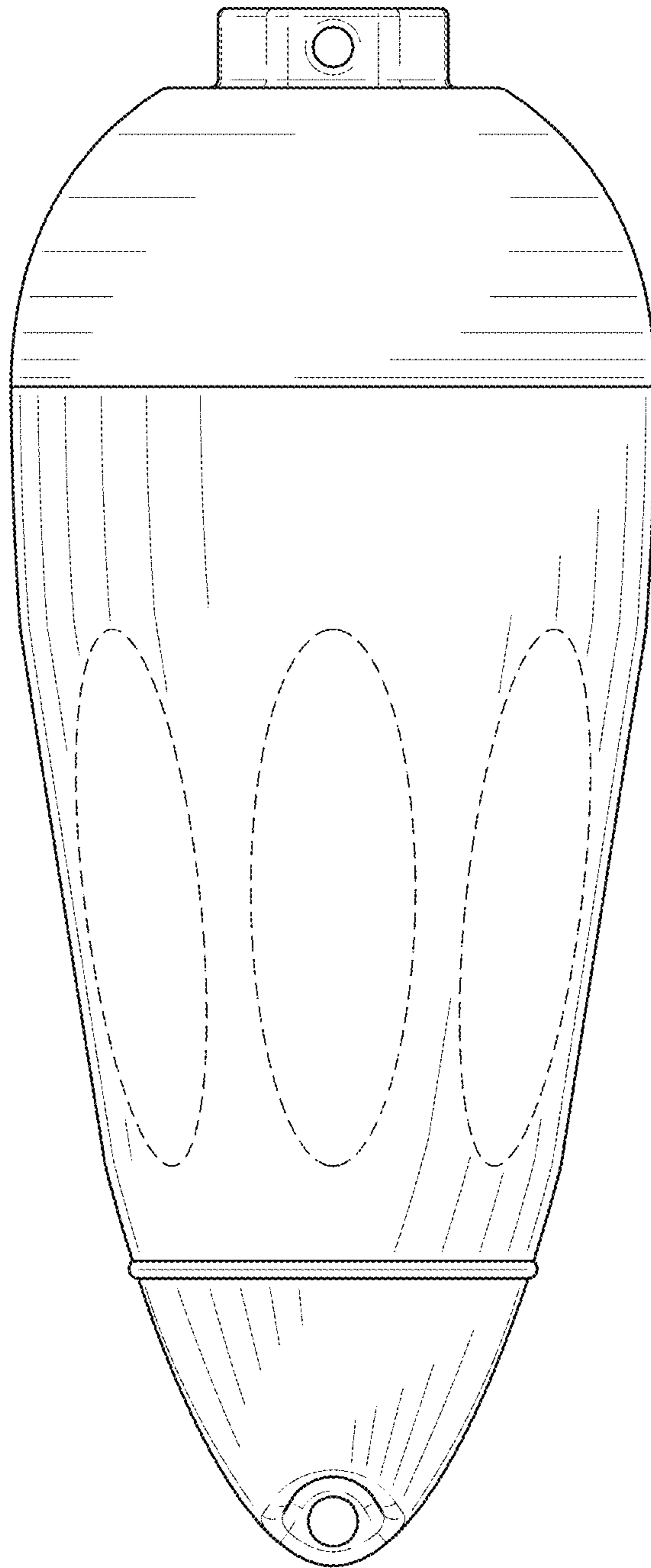

FIG. 12

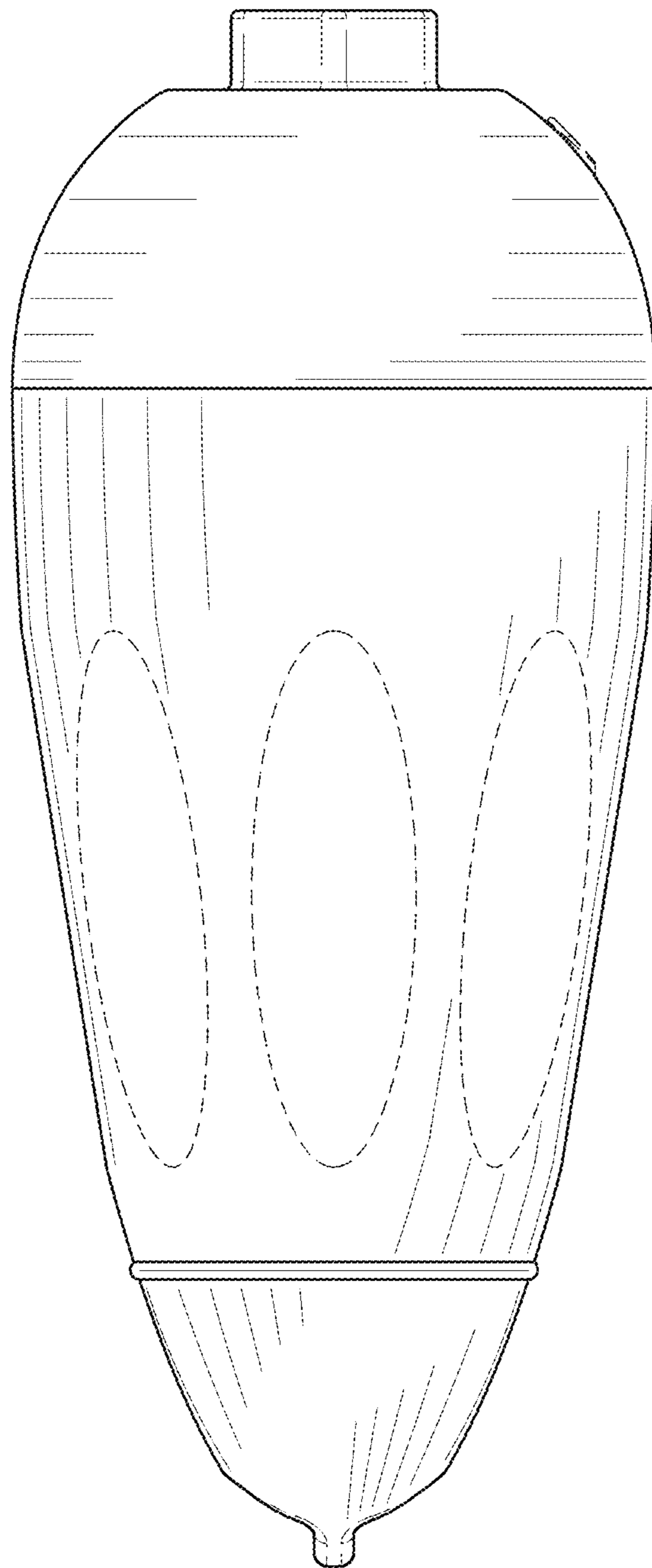

FIG. 13

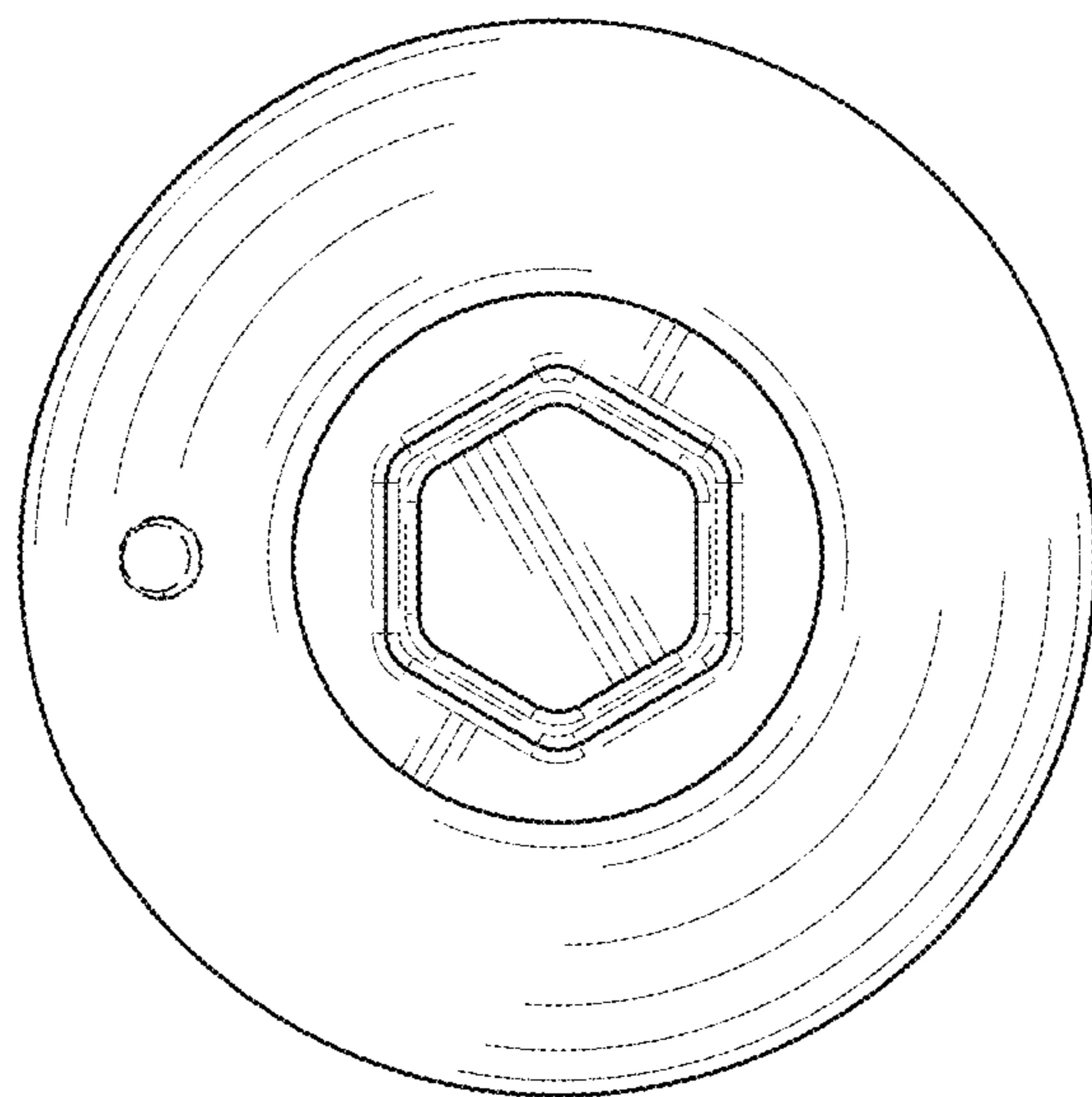

FIG. 14

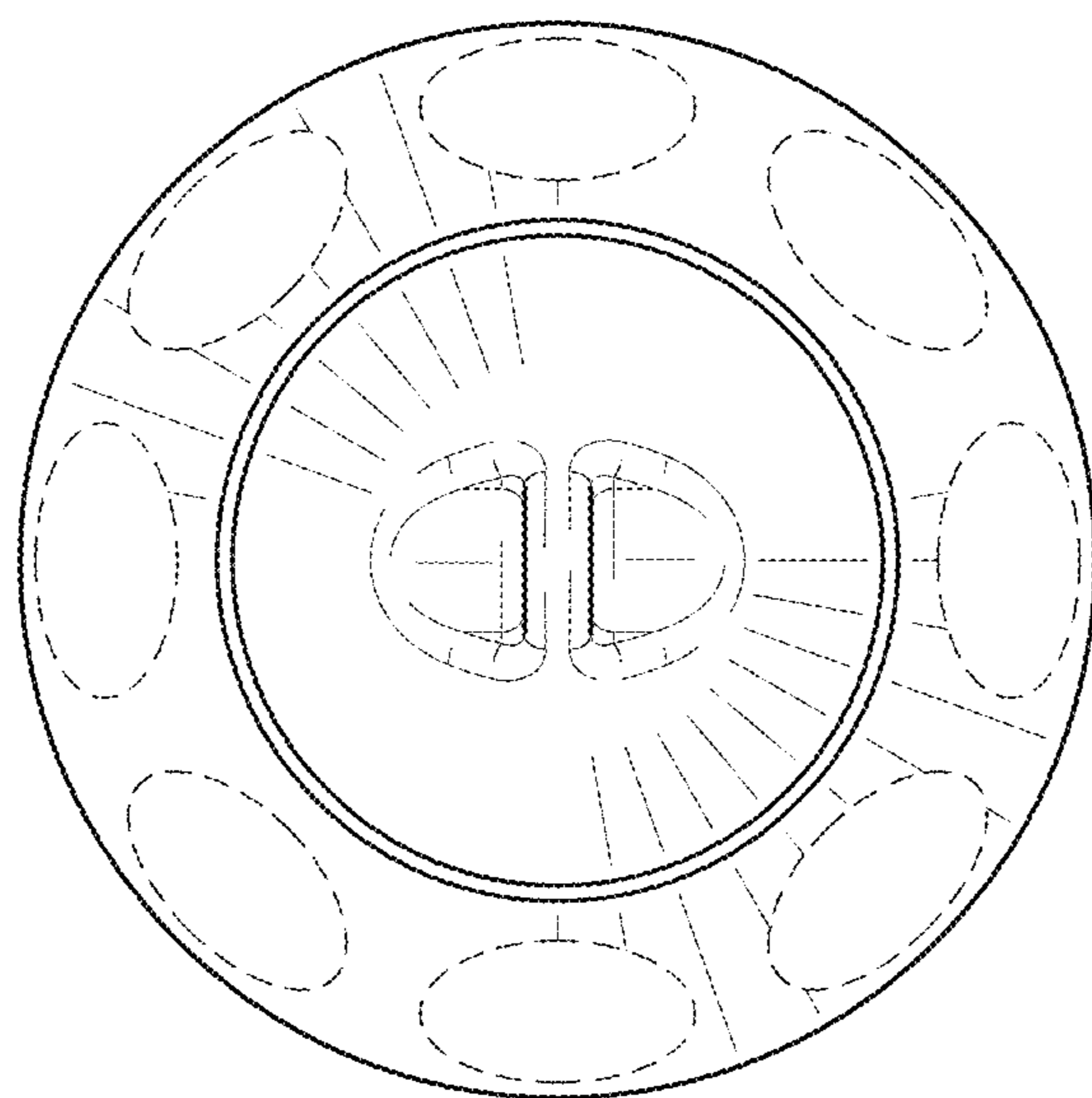

FIG. 15

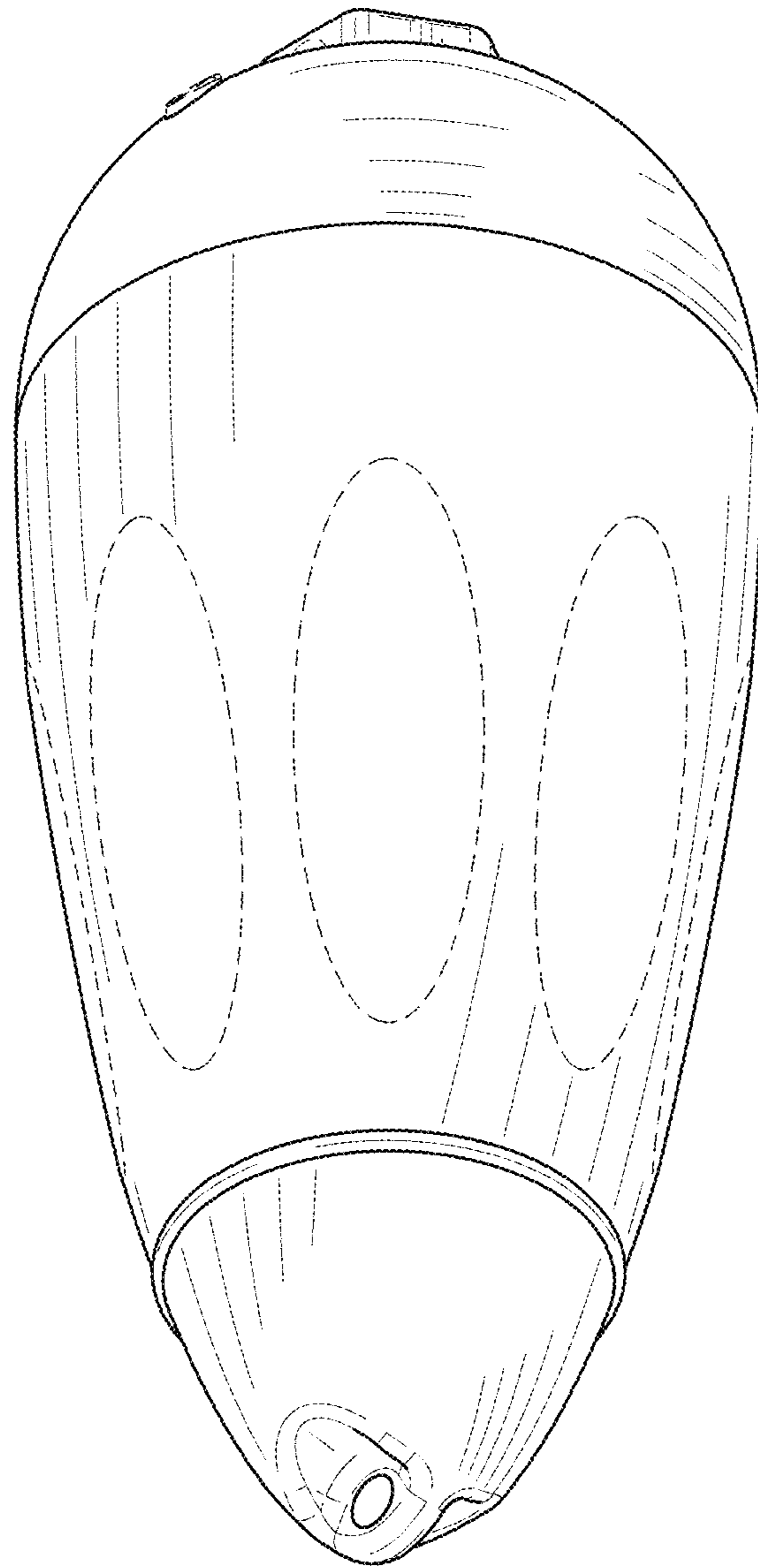

FIG. 16