



US00D776229S

(12) **United States Design Patent**  
**Cook, Jr. et al.**

(10) **Patent No.:** **US D776,229 S**  
(45) **Date of Patent:** **\*\* Jan. 10, 2017**

(54) **FISHING LURE**

(71) Applicants: **Victor J. Cook, Jr.**, Columbus, OH  
(US); **Grant Koppers**,  
Niagara-On-The-Lake (CA)

(72) Inventors: **Victor J. Cook, Jr.**, Columbus, OH  
(US); **Grant Koppers**,  
Niagara-On-The-Lake (CA)

(73) Assignee: **Koppers Fishing and Tackle Corp.**,  
Niagara-On-The-Lake, Ontario (CA)

(\*\*) Term: **15 Years**

(21) Appl. No.: **29/533,116**

(22) Filed: **Jul. 14, 2015**

(51) **LOC (10) Cl.** ..... **22-05**

(52) **U.S. Cl.**  
USPC ..... **D22/133**

(58) **Field of Classification Search**  
USPC ..... D22/126-133; 43/42.28, 42.45, 42.08,  
43/42.06, 42.4, 17.6, 42.44, 42.47  
CPC ..... A01K 85/00; A01K 85/005; A01K 85/18;  
A01K 85/16; A01K 83/02  
See application file for complete search history.

(56) **References Cited**

**U.S. PATENT DOCUMENTS**

2,499,718 A \* 3/1950 Boshears ..... A01K 85/16  
43/42.44  
4,962,609 A \* 10/1990 Walker ..... A01K 85/01  
43/42.06

D692,520 S \* 10/2013 Vainio ..... D22/133  
D713,926 S \* 9/2014 Vainio ..... D22/133  
D742,479 S \* 11/2015 Cook, Jr. .... D22/133  
D767,080 S \* 9/2016 Vainio ..... D22/133

**OTHER PUBLICATIONS**

South Carolina Sportsman, Are BaitBalls the next step in “multiple baitfish” presentations?, Article, Brian Cope Feb. 10, 2015.\*

\* cited by examiner

*Primary Examiner* — Catheri Oliver-Garcia

(74) *Attorney, Agent, or Firm* — Wm. Cates Rambo

(57) **CLAIM**

The ornamental design for a fishing lure, as shown and described.

**DESCRIPTION**

FIG. 1 is a perspective view of a fishing lure;  
FIG. 2 is a left side elevational view thereof;  
FIG. 3 is a right side elevational view thereof;  
FIG. 4 is a top plan view thereof;  
FIG. 5 is a bottom plan view thereof;  
FIG. 6 is a front elevational view thereof;  
FIG. 7 is a rear elevational view thereof; and,  
FIG. 8 is a perspective view of a variation of the subject lure.  
The portions of the fishing lure shown in broken lines are included for purposes of illustration only and form no part of the claimed design.

**1 Claim, 4 Drawing Sheets**

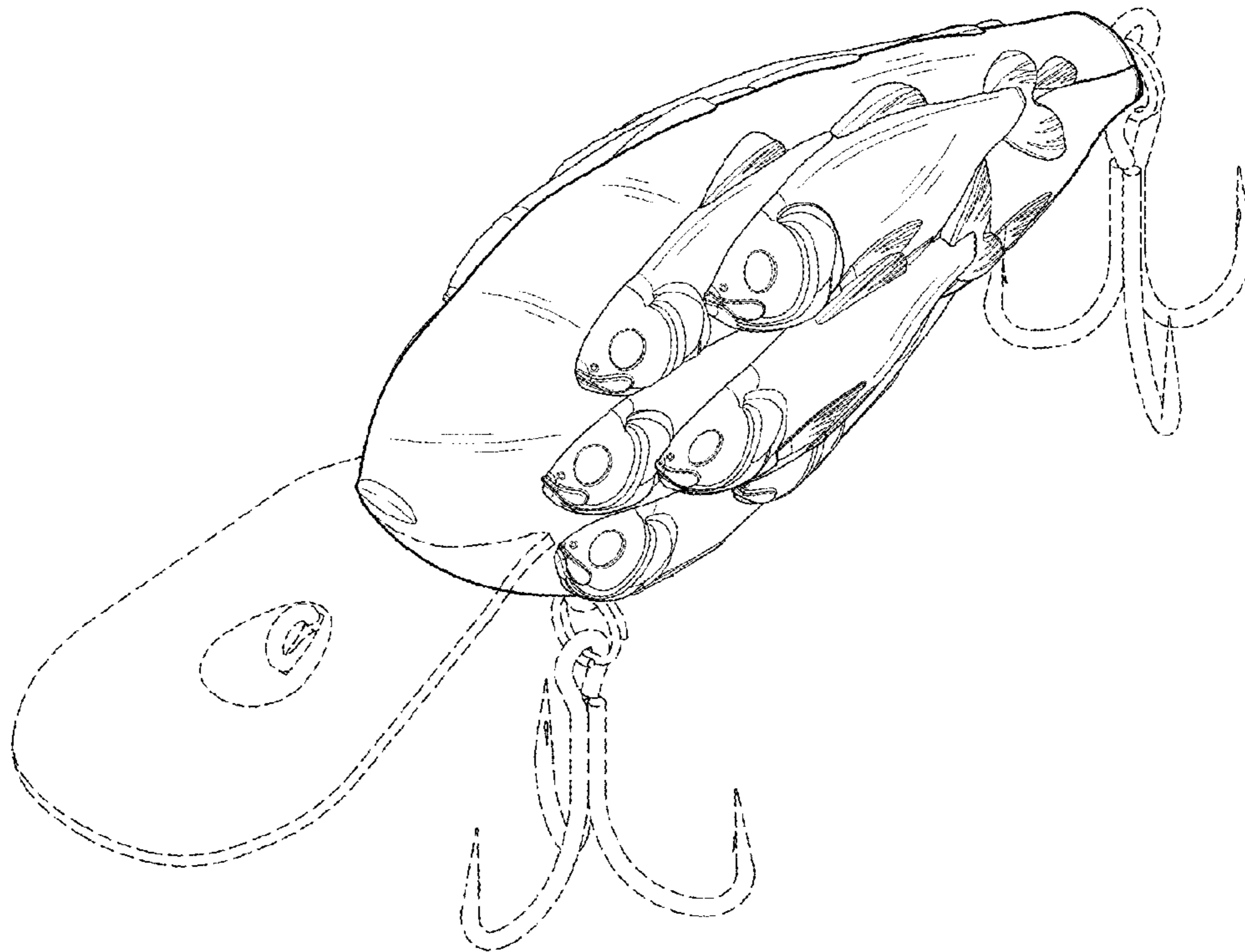

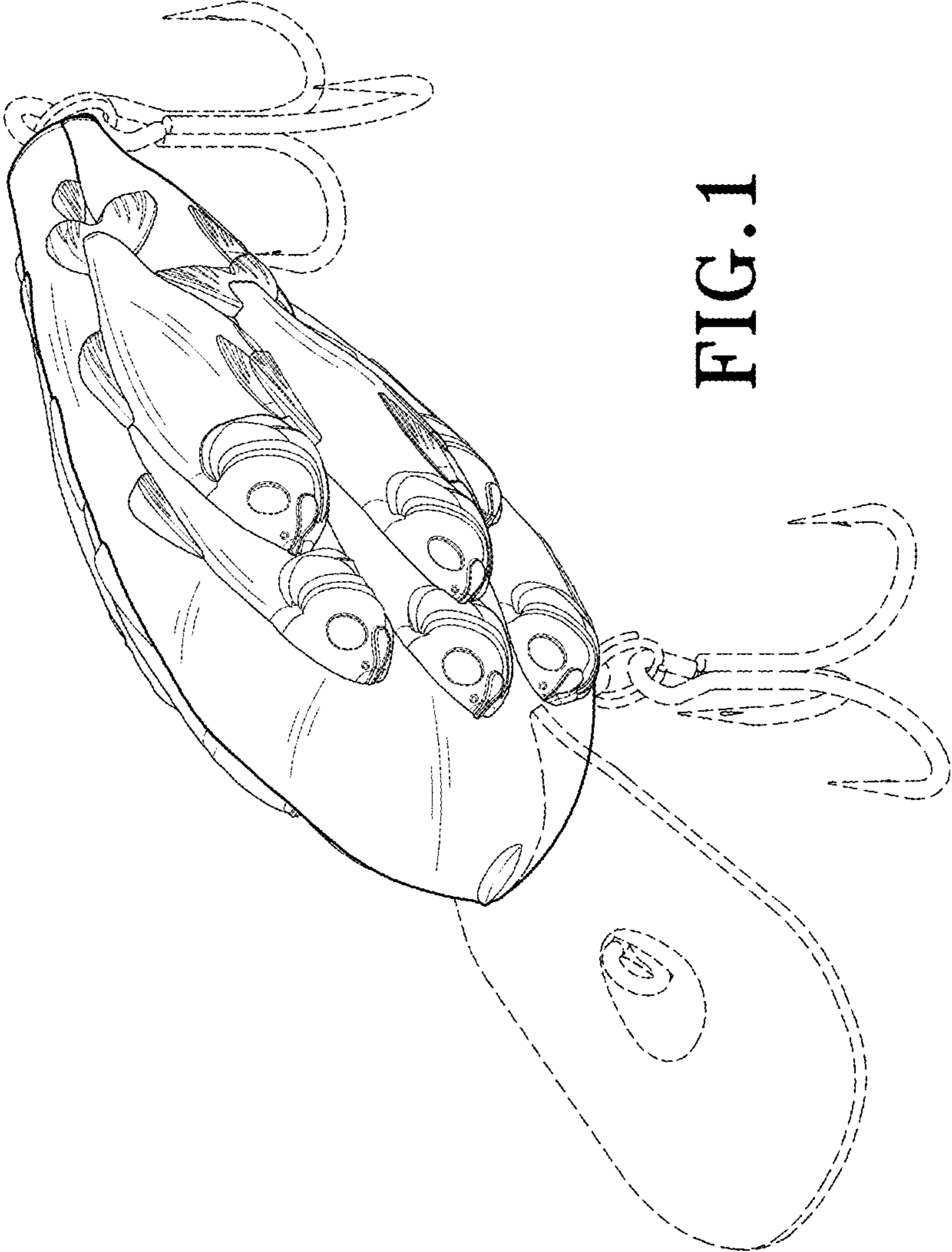

FIG. 1

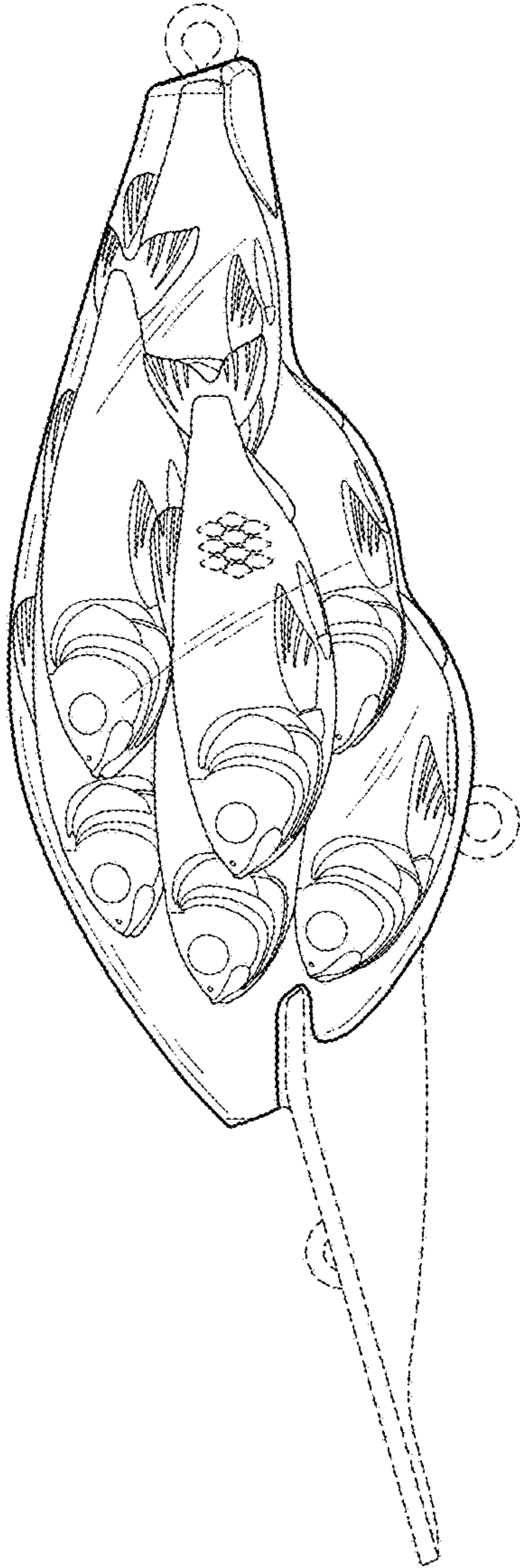

FIG. 2

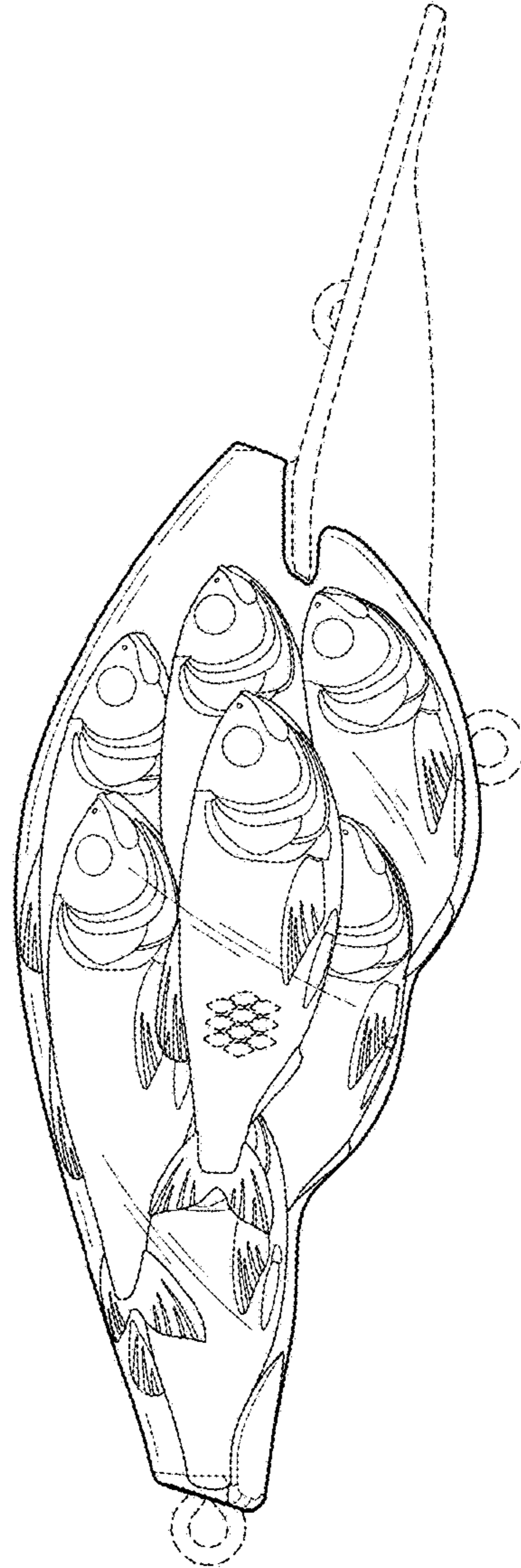

FIG. 3



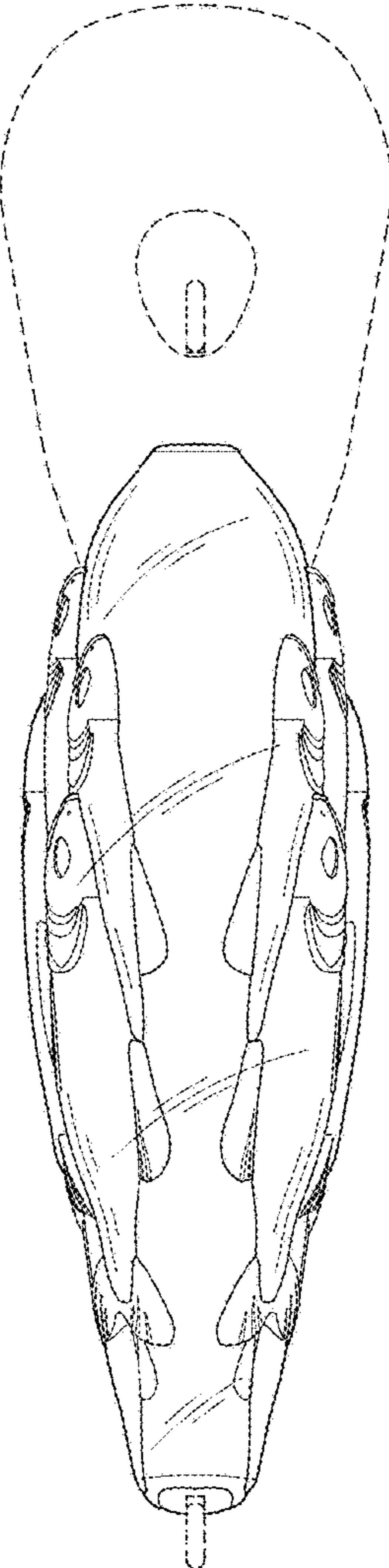

FIG. 4

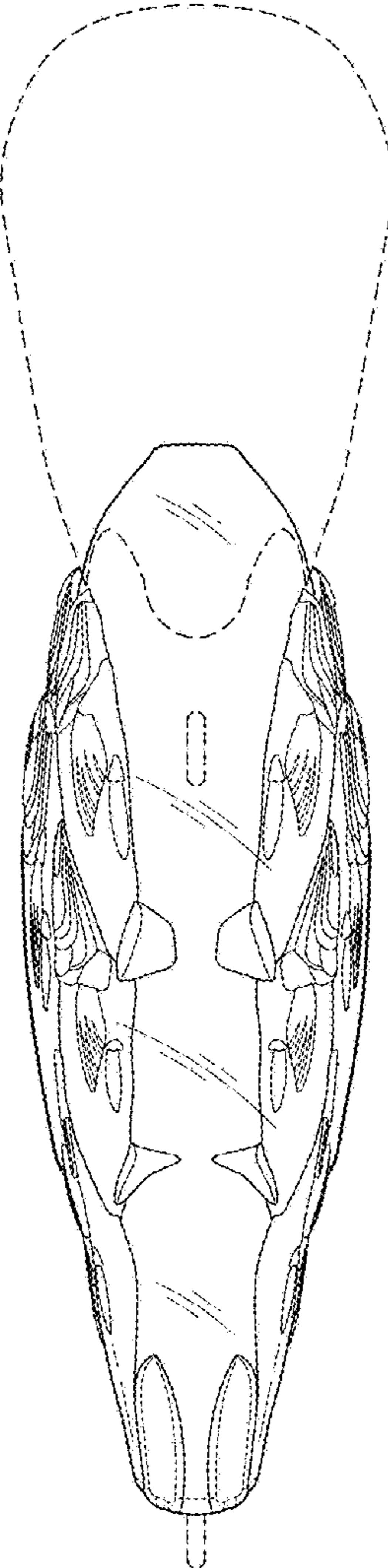

FIG. 5

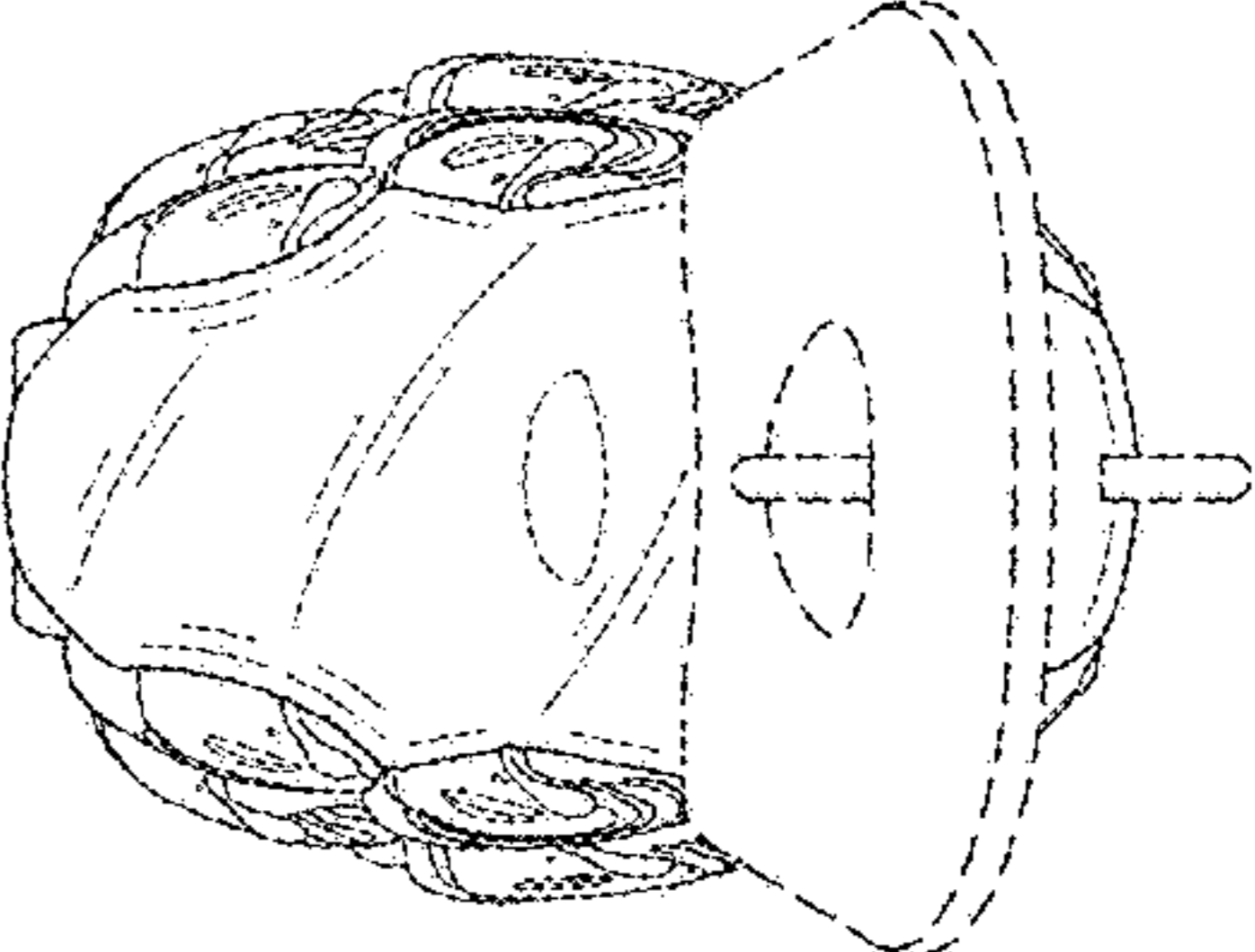

FIG. 6

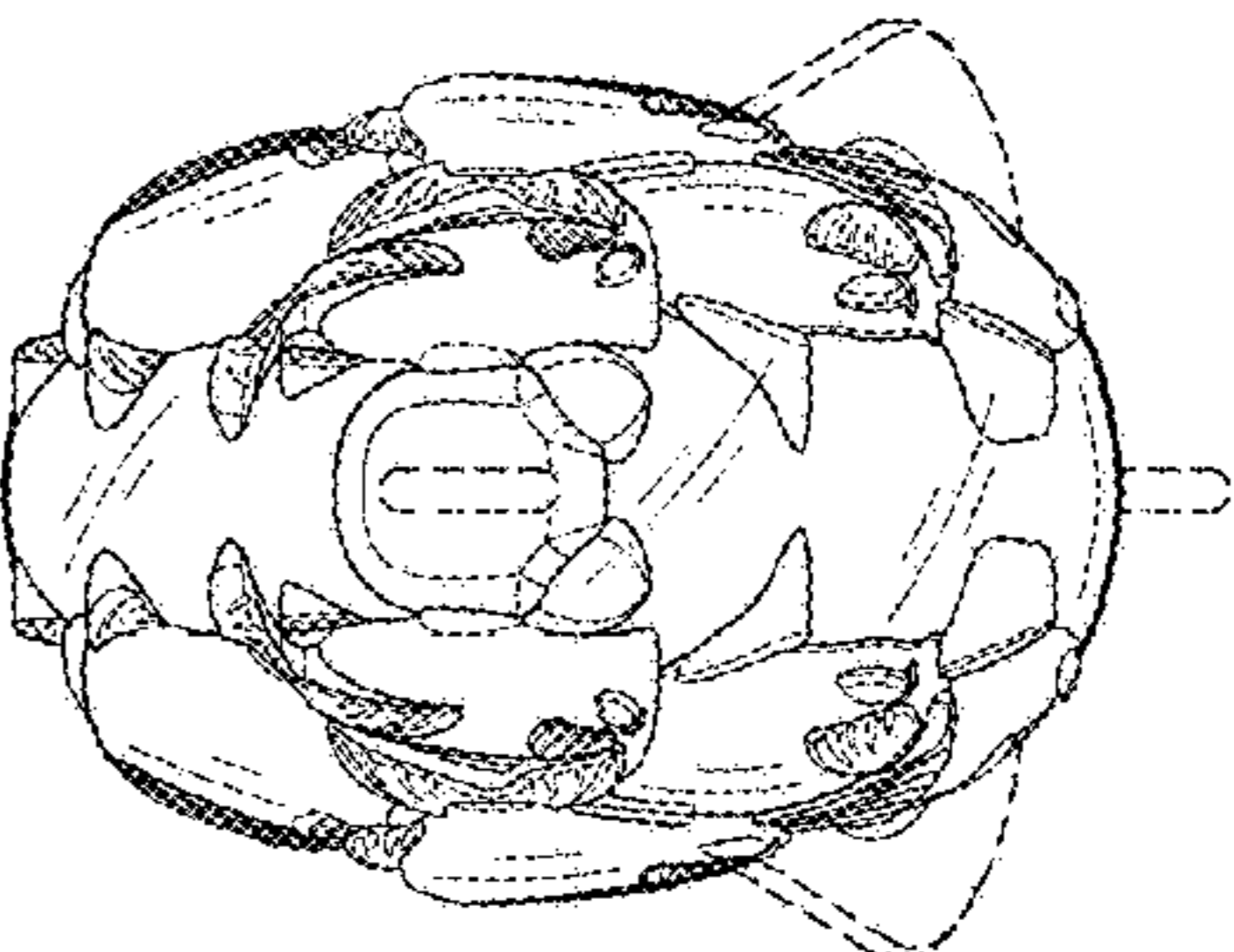

FIG. 7

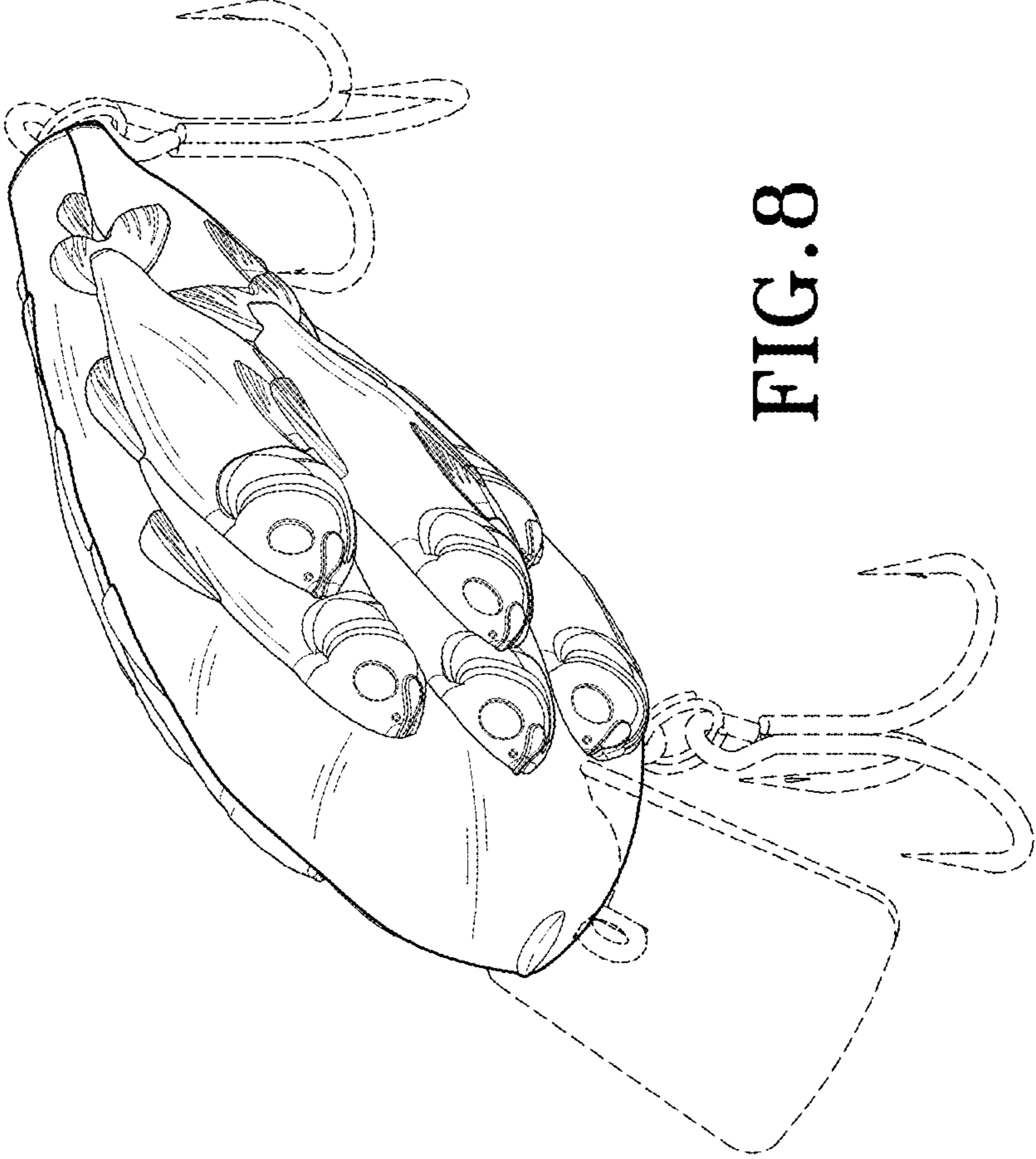

FIG. 8