



US00D776216S

(12) **United States Design Patent**
Schweigert et al.

(10) **Patent No.:** **US D776,216 S**
(45) **Date of Patent:** **** Jan. 10, 2017**

(54) **GOLF CLUB HEAD**

(71) Applicant: **PARSONS XTREME GOLF, LLC**,
Scottsdale, AZ (US)
(72) Inventors: **Bradley D. Schweigert**, Anthem, AZ
(US); **Michael R. Nicolette**, Scottsdale,
AZ (US)
(73) Assignee: **PARSONS XTREME GOLF, LLC**,
Scottsdale, AZ (US)

(**) Term: **15 Years**

(21) Appl. No.: **29/574,093**

(22) Filed: **Aug. 11, 2016**

Related U.S. Application Data

(63) Continuation-in-part of application No. 29/569,724,
filed on Jun. 30, 2016.

(51) **LOC (10) Cl.** **21-02**

(52) **U.S. Cl.**
USPC **D21/752**

(58) **Field of Classification Search**
USPC D21/733, 752, 759
CPC A63B 53/04; A63B 53/0466; A63B
2053/002; A63B 2053/0445; A63B
2053/0433; A63B 2053/0437; A63B
2053/0491

See application file for complete search history.

(56) **References Cited**

U.S. PATENT DOCUMENTS

1,133,129 A 3/1915 Govan
1,269,745 A 6/1918 Robertson
1,306,029 A 6/1919 Robertson
D55,867 S 7/1920 Mattern
1,534,600 A 4/1925 Mattern
1,538,312 A 5/1925 Beat
D138,437 S 8/1944 Link
D138,438 S 8/1944 Link
D138,439 S 8/1944 Link
D138,441 S 8/1944 Link

D138,442 S 8/1944 Link
D164,469 S 9/1951 Behrendt
D185,177 S 5/1959 Smith
3,020,048 A 2/1962 Carroll
D203,936 S 3/1966 Long
D215,101 S 9/1969 Sabat
3,556,553 A 1/1971 Kolbe
3,652,094 A 3/1972 Glover
D229,431 S * 11/1973 Baker D21/752
D234,609 S 3/1975 Raymond
D234,963 S 4/1975 Hirata
D239,555 S 4/1976 Timbrook
D240,054 S 5/1976 Meissler
D240,748 S 7/1976 Bock
4,085,934 A 4/1978 Churchward
D253,778 S * 12/1979 Madison D21/752
D261,167 S 10/1981 Swanson
4,332,388 A 6/1982 Crow
D294,617 S 3/1988 Perkins
4,754,977 A 7/1988 Sahm
4,824,116 A 4/1989 Nagamoto et al.
D307,783 S 5/1990 Iinuma
4,988,104 A 1/1991 Shiotani et al.
D326,885 S 6/1992 Paul
5,158,296 A 10/1992 Lee
5,176,384 A 1/1993 Sata et al.
5,213,328 A 5/1993 Long et al.
5,213,329 A 5/1993 Okumoto et al.
D336,672 S 6/1993 Gorman
D344,561 S 2/1994 Gorman
D351,883 S * 10/1994 Solheim D21/752
D353,862 S 12/1994 Saito
D357,520 S 4/1995 Helmstetter et al.
5,419,560 A 5/1995 Bamber
5,425,535 A 6/1995 Gee
D361,358 S 8/1995 Simmons
5,447,311 A 9/1995 Viollaz et al.
5,451,056 A 9/1995 Manning
D362,884 S 10/1995 Blough et al.
D362,885 S 10/1995 Blough et al.
D362,887 S 10/1995 Blough et al.
5,518,243 A * 5/1996 Redman A63B 53/04
473/334
D370,514 S 6/1996 Blough et al.
D371,816 S 7/1996 Yoshioka
5,540,437 A 7/1996 Bamber
D378,111 S * 2/1997 Parente D21/752
5,637,045 A 6/1997 Igarashi
D384,120 S * 9/1997 De La Cruz D21/752
5,669,830 A 9/1997 Bamber
D389,541 S 1/1998 Huan-Chiang
D395,476 S 6/1998 Pond et al.
5,766,091 A 6/1998 Humphrey et al.

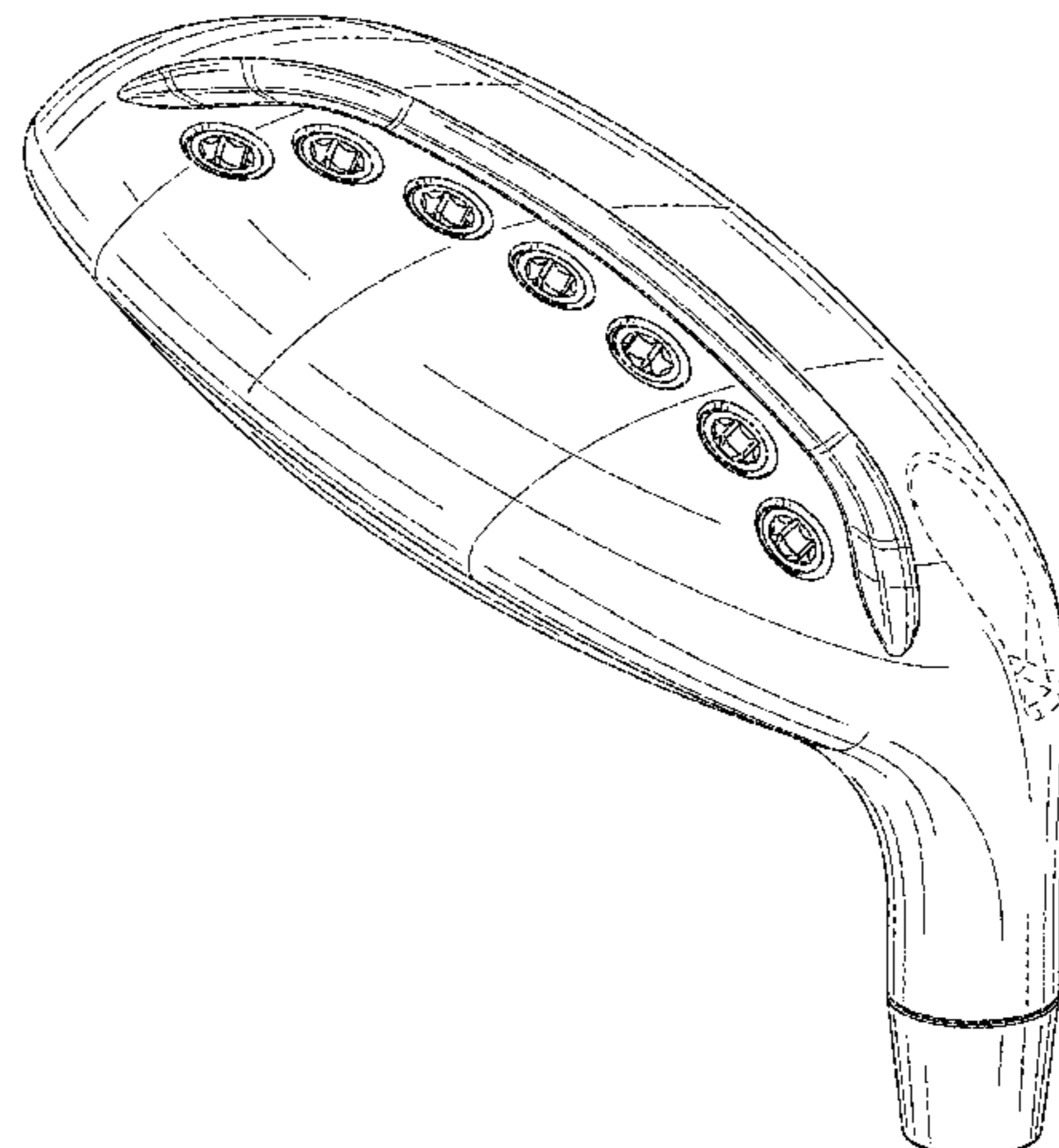
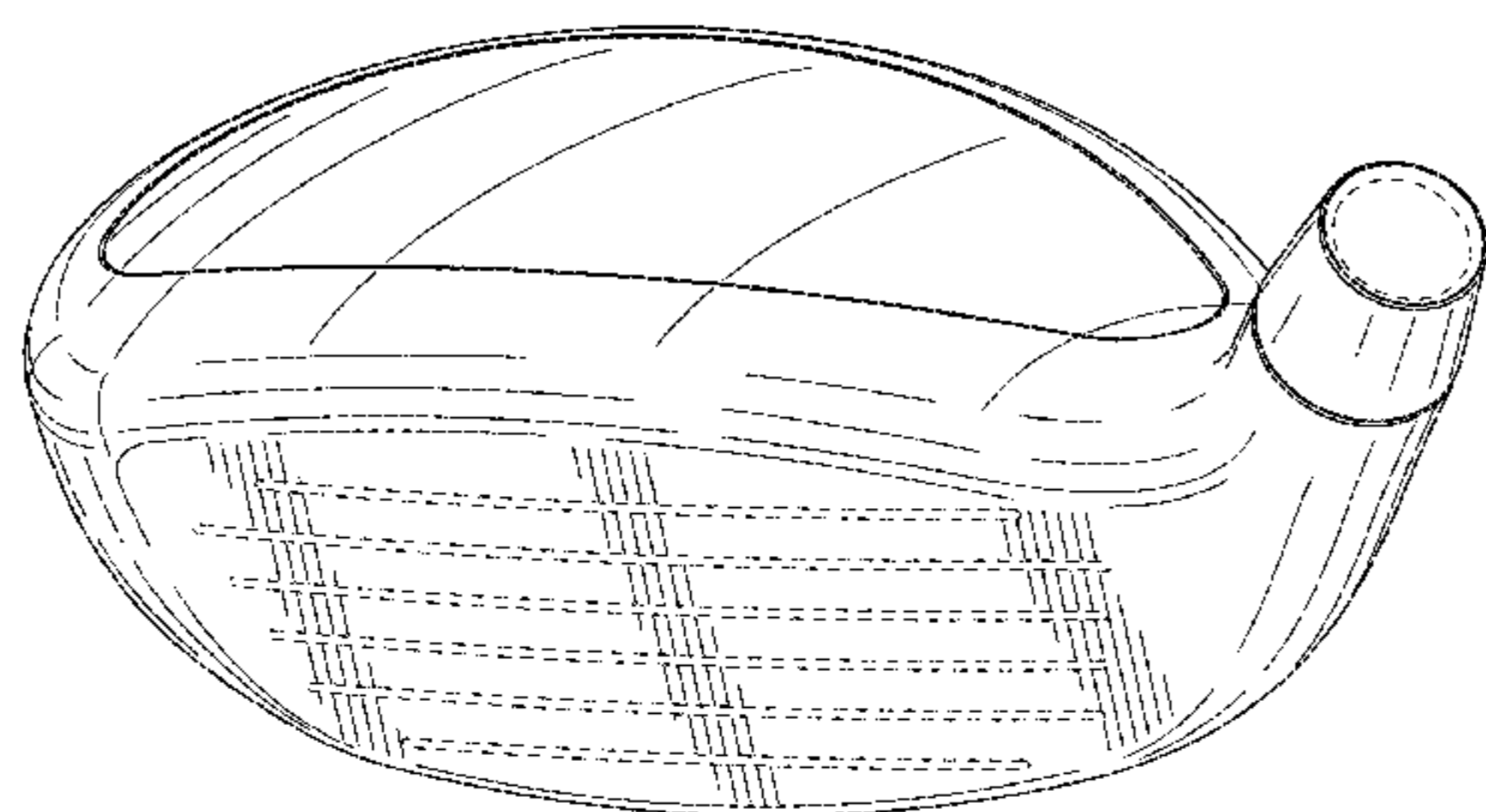

(56)

References Cited

U.S. PATENT DOCUMENTS

5,766,092 A	6/1998	Mimeur et al.		7,207,900 B2	4/2007	Nicolette et al.
5,788,584 A *	8/1998	Parente	A63B 53/04 473/290	D543,601 S	5/2007	Kawami
D399,277 S	10/1998	Ezaki		7,223,180 B2	5/2007	Willett et al.
5,827,132 A	10/1998	Bamber		D552,198 S	10/2007	Schweigert et al.
D400,625 S	11/1998	Kubica et al.		D555,219 S	11/2007	Lin
D400,627 S	11/1998	Kubica et al.		D557,363 S	12/2007	Jertson et al.
D405,489 S	2/1999	Kubica et al.		D558,287 S	12/2007	Jertson et al.
D405,492 S	2/1999	Kubica et al.		D558,288 S	12/2007	Jertson et al.
D408,485 S	4/1999	Takahashi et al.		7,303,486 B2	12/2007	Imamoto
5,899,821 A	5/1999	Hsu et al.		D559,932 S	1/2008	Belmont
5,935,016 A	8/1999	Antonious		D560,262 S *	1/2008	Nguyen D21/752
D414,535 S	9/1999	Mertens		D562,421 S	2/2008	Jertson et al.
D421,080 S	2/2000	Chen		D563,498 S	3/2008	Jertson et al.
D426,276 S	6/2000	Besnard et al.		D564,054 S	3/2008	Jertson et al.
6,077,171 A	6/2000	Yoneyama		D564,055 S	3/2008	Jertson et al.
D442,659 S	5/2001	Kubica et al.		7,338,388 B2	3/2008	Schweigert et al.
D443,008 S	5/2001	Kubica et al.		7,347,794 B2	3/2008	Schweigert
D444,830 S	7/2001	Kubica et al.		D567,317 S	4/2008	Jertson et al.
D445,862 S	7/2001	Ford		7,351,164 B2	4/2008	Schweigert et al.
6,290,609 B1	9/2001	Takeda		D569,933 S	5/2008	Jertson et al.
D448,824 S	10/2001	Koizumi et al.		D569,934 S	5/2008	Jertson et al.
D449,866 S	10/2001	Miller		D569,935 S	5/2008	Schweigert et al.
D457,211 S	5/2002	Bakke		D569,936 S	5/2008	Schweigert et al.
D469,833 S	2/2003	Roberts et al.		D569,942 S	5/2008	Jertson et al.
D473,605 S	4/2003	Petersen et al.		D570,937 S	6/2008	Schweigert et al.
D475,107 S	5/2003	Madore		D570,938 S	6/2008	Jertson et al.
D476,048 S	6/2003	Cleveland et al.		7,396,299 B2	7/2008	Nicolette et al.
D478,140 S	8/2003	Burrows		7,407,447 B2	8/2008	Beach et al.
D478,949 S	8/2003	DeLaCruz		7,410,425 B2	8/2008	Willett et al.
D481,087 S	10/2003	Antonious		7,410,426 B2	8/2008	Willett et al.
6,638,182 B2	10/2003	Kosmatka		7,419,441 B2	9/2008	Hoffman et al.
6,695,714 B1	2/2004	Bliss et al.		7,448,963 B2	11/2008	Beach et al.
6,702,693 B2	3/2004	Bamber		7,448,964 B2	11/2008	Schweigert et al.
6,773,360 B2	8/2004	Willett et al.		D584,370 S	1/2009	Cleveland et al.
6,780,123 B2	8/2004	Hasebe		7,530,904 B2	5/2009	Beach et al.
D497,963 S	11/2004	Toulon et al.		D594,518 S	6/2009	Schweigert
6,811,496 B2	11/2004	Wahl et al.		D594,520 S	6/2009	Schweigert et al.
D499,779 S	12/2004	Mahaffey et al.		D594,521 S	6/2009	Jertson et al.
D502,975 S	3/2005	Schweigert et al.		D594,919 S	6/2009	Schweigert et al.
D503,204 S	3/2005	Nicolette et al.		7,540,811 B2	6/2009	Beach et al.
D507,320 S	7/2005	Roberts et al.		D597,620 S	8/2009	Taylor et al.
D508,545 S	8/2005	Roberts et al.		7,568,985 B2	8/2009	Beach et al.
D508,969 S	8/2005	Hasebe		7,578,753 B2	8/2009	Beach et al.
6,923,733 B2	8/2005	Chen		D600,297 S	9/2009	Jertson et al.
6,939,247 B1	9/2005	Schweigert et al.		7,584,531 B2	9/2009	Schweigert et al.
D513,051 S	12/2005	Barez et al.		7,588,502 B2	9/2009	Nishino
D514,179 S	1/2006	Chen et al.		7,591,738 B2	9/2009	Beach et al.
D514,183 S	1/2006	Schweigert et al.		D603,472 S	11/2009	Schweigert et al.
D514,185 S	1/2006	Barez et al.		D604,783 S	11/2009	Nicolette et al.
D516,650 S	3/2006	Wolfe et al.		7,611,424 B2 *	11/2009	Nagai A63B 53/0466 473/334
D518,863 S	4/2006	Motoyoshi et al.		7,621,823 B2	11/2009	Beach et al.
D520,585 S	5/2006	Hasebe		D605,715 S	12/2009	Barez et al.
D520,586 S	5/2006	Bingman		D606,605 S	12/2009	Wada et al.
D522,077 S	5/2006	Schweigert et al.		D607,070 S	12/2009	Wada et al.
D522,601 S	6/2006	Schweigert et al.		D607,071 S	12/2009	Wada et al.
D523,104 S	6/2006	Hasebe		7,632,194 B2	12/2009	Beach et al.
D523,498 S	6/2006	Chen et al.		7,658,686 B2	2/2010	Soracco
D523,501 S	6/2006	Nicolette et al.		D612,438 S	3/2010	Carlyle et al.
D523,917 S	6/2006	Wolfe et al.		D612,439 S	3/2010	Carlyle et al.
D524,889 S	7/2006	Yu et al.		7,713,142 B2	5/2010	Hoffman et al.
D526,694 S	8/2006	Schweigert et al.		7,717,804 B2	5/2010	Beach et al.
7,121,956 B2	10/2006	Lo		7,717,805 B2	5/2010	Beach et al.
7,128,663 B2	10/2006	Bamber		D617,406 S	6/2010	Carlyle et al.
D534,595 S	1/2007	Hasebe		D618,293 S	6/2010	Foster et al.
D534,599 S	1/2007	Barez et al.		D618,746 S	6/2010	Jertson et al.
7,156,751 B2	1/2007	Wahl et al.		D618,747 S	6/2010	Schweigert et al.
7,166,040 B2	1/2007	Hoffman et al.		D618,753 S	6/2010	Jertson et al.
D536,401 S *	2/2007	Kawami	D21/759	D618,754 S	6/2010	Schweigert et al.
D536,403 S	2/2007	Kawami		7,744,484 B1	6/2010	Chao
D537,495 S	2/2007	Schweigert et al.		D621,893 S	8/2010	Nicolette et al.
7,182,698 B2	2/2007	Tseng		7,798,203 B2	9/2010	Schweigert et al.
D538,363 S	3/2007	Schweigert et al.		7,798,917 B2	9/2010	Nguyen et al.
D538,371 S *	3/2007	Kawami	D21/759	7,815,521 B2	10/2010	Ban et al.
7,186,190 B1	3/2007	Beach et al.		7,846,040 B2	12/2010	Ban
				7,846,041 B2	12/2010	Beach et al.
				D633,967 S	3/2011	Carlyle et al.
				D635,626 S	4/2011	Nicolette
				7,927,229 B2	4/2011	Jertson et al.

(56)

References Cited

U.S. PATENT DOCUMENTS

D638,893 S 5/2011 Schweigert et al.
 D638,896 S 5/2011 Schweigert et al.
 7,938,738 B2 5/2011 Roach
 7,963,861 B2 6/2011 Beach et al.
 D643,490 S 8/2011 Wada et al.
 8,012,038 B1 9/2011 Beach et al.
 D647,585 S 10/2011 Jertson et al.
 8,062,150 B2 11/2011 Gilbert et al.
 8,088,025 B2 1/2012 Wahl et al.
 8,092,319 B1 1/2012 Cackett et al.
 8,105,180 B1 1/2012 Cackett et al.
 D658,248 S 4/2012 Nunez et al.
 D661,751 S 6/2012 Nicolette et al.
 D661,756 S 6/2012 Nicolette et al.
 8,221,262 B1 7/2012 Cackett et al.
 8,246,487 B1 8/2012 Cackett et al.
 8,257,196 B1 9/2012 Abbott et al.
 8,257,197 B2 9/2012 Schweigert
 8,262,506 B2 9/2012 Watson et al.
 8,328,662 B2 12/2012 Nakamura et al.
 D673,630 S 1/2013 Schweigert
 D673,632 S 1/2013 Schweigert et al.
 8,371,957 B2 2/2013 Schweigert et al.
 8,376,878 B2 2/2013 Bennett et al.
 D680,179 S 4/2013 Solheim et al.
 D681,142 S 4/2013 Fossum et al.
 8,414,422 B2 4/2013 Peralta et al.
 8,485,919 B2 7/2013 Rice et al.
 8,506,420 B2 8/2013 Hocknell et al.
 D689,156 S 9/2013 Stokke et al.
 D691,230 S 10/2013 Chen et al.
 8,545,343 B2 10/2013 Boyd et al.
 8,562,457 B2 10/2013 Beach et al.
 8,574,094 B2 11/2013 Nicolette et al.
 8,608,587 B2 12/2013 Henrikson et al.
 8,628,431 B2 1/2014 Schweigert et al.
 8,657,700 B2 2/2014 Nicolette et al.
 8,663,026 B2 3/2014 Blowers et al.
 8,690,710 B2 4/2014 Nicolette et al.
 D707,316 S 6/2014 Aguayo et al.
 D707,317 S 6/2014 Aguayo et al.
 8,753,230 B2 6/2014 Stokke et al.
 8,777,778 B2 * 7/2014 Solheim A63B 53/0466
 473/345
 8,784,232 B2 7/2014 Jertson et al.
 8,790,196 B2 * 7/2014 Solheim A63B 53/0466
 473/344
 8,808,108 B2 8/2014 Schweigert
 D712,989 S 9/2014 Gillig
 8,826,512 B2 9/2014 Schweigert
 8,827,832 B2 9/2014 Breier et al.
 8,827,833 B2 9/2014 Amano et al.
 8,845,455 B2 9/2014 Ban et al.
 D714,894 S 10/2014 Tang et al.
 D716,387 S 10/2014 Aguayo et al.
 D716,388 S 10/2014 Aguayo et al.
 8,858,362 B1 10/2014 Leposky et al.
 D721,544 S 1/2015 Hollander
 D722,351 S 2/2015 Parsons et al.
 D722,352 S 2/2015 Nicolette et al.
 D723,120 S 2/2015 Nicolette
 8,961,336 B1 2/2015 Parsons et al.
 D724,164 S * 3/2015 Schweigert D21/752
 D725,208 S 3/2015 Schweigert
 D726,265 S 4/2015 Nicolette
 D726,846 S 4/2015 Schweigert
 D729,892 S * 5/2015 Nicolette D21/752
 D733,234 S * 6/2015 Nicolette D21/752
 D738,449 S 9/2015 Schweigert
 D739,487 S 9/2015 Schweigert
 9,199,140 B1 * 12/2015 Schweigert A63B 53/0466
 9,199,143 B1 12/2015 Parsons et al.
 D746,927 S * 1/2016 Parsons D21/752
 D748,214 S 1/2016 Nicolette et al.
 D748,215 S 1/2016 Parsons et al.

D748,749 S 2/2016 Nicolette et al.
 D753,251 S * 4/2016 Schweigert D21/759
 D753,252 S 4/2016 Schweigert
 D755,319 S * 5/2016 Nicolette D21/759
 D756,471 S 5/2016 Nicolette et al.
 9,352,197 B2 5/2016 Schweigert et al.
 D759,178 S * 6/2016 Nicolette D21/759
 D760,334 S * 6/2016 Schweigert D21/752
 9,399,158 B2 7/2016 Schweigert et al.
 D764,614 S * 8/2016 Parsons D21/759
 D767,696 S * 9/2016 Parsons D21/752
 2002/0107087 A1 8/2002 Fagot
 2003/0139226 A1 7/2003 Cheng et al.
 2003/0176231 A1 9/2003 Hasebe
 2004/0204263 A1 10/2004 Fagot et al.
 2005/0009632 A1 1/2005 Schweigert et al.
 2005/0014573 A1 1/2005 Lee
 2005/0119066 A1 6/2005 Stites et al.
 2005/0239569 A1 10/2005 Best et al.
 2005/0277485 A1 12/2005 Hou et al.
 2006/0105856 A1 5/2006 Lo
 2006/0111200 A1 5/2006 Poynor
 2007/0032308 A1 2/2007 Fagot et al.
 2007/0225084 A1 9/2007 Schweigert et al.
 2007/0293344 A1 12/2007 Davis
 2008/0004133 A1 1/2008 Schweigert
 2008/0058113 A1 3/2008 Nicolette et al.
 2008/0188322 A1 8/2008 Anderson et al.
 2008/0300065 A1 12/2008 Schweigert
 2009/0029790 A1 1/2009 Nicolette et al.
 2009/0029795 A1 1/2009 Schweigert et al.
 2010/0130306 A1 5/2010 Schweigert
 2010/0144461 A1 6/2010 Ban
 2010/0178999 A1 7/2010 Nicolette et al.
 2011/0111883 A1 5/2011 Cackett
 2011/0143858 A1 6/2011 Peralta et al.
 2011/0165963 A1 7/2011 Cackett et al.
 2011/0269567 A1 11/2011 Ban et al.
 2011/0294596 A1 12/2011 Ban
 2012/0202615 A1 8/2012 Beach et al.
 2013/0137532 A1 5/2013 Deshmukh et al.
 2013/0225319 A1 8/2013 Kato
 2013/0281226 A1 10/2013 Ban
 2013/0288823 A1 10/2013 Hebreo
 2013/0303303 A1 11/2013 Ban
 2013/0303304 A1 11/2013 Sato
 2013/0310192 A1 11/2013 Wahl et al.
 2014/0080621 A1 3/2014 Nicolette et al.
 2014/0128175 A1 5/2014 Jertson et al.
 2014/0274441 A1 9/2014 Greer
 2014/0274451 A1 9/2014 Knight et al.
 2015/0231454 A1 8/2015 Parsons et al.
 2015/0231806 A1 8/2015 Parsons et al.

OTHER PUBLICATIONS

International Search Report and Written Opinion issued in connection with corresponding application No. PCT/US2015/016666, on May 14, 2015 (8 pages).
 International Search Report and Written Opinion received in connection with PCT/US15/42484 on Oct. 19, 2015 (12 pages).
 International Search Report and Written Opnion received in connection with PCT Application PCTUS2015042282 on Oct. 13, 2015 (12 pages).
 Kozuchowski, Zak, "Callaway Mack Daddy 2 PM Grind Wedges" (<http://www.golfwrx.com/276203/callaway-mack-daddy-2-pm-grind-wedges/>), www.golfwrx.com, GolfWRX Holdings, LLC, published Jan. 21, 2015.
 Wall, Jonathan, "Details: Phil's Prototype Mack Daddy PM-Grind Wedge," (<http://www.pgatour.com/equipmentreport/2015/01/21/callaway-wedge.html>), www.pgatour.com, PGA Tour, Inc., published Jan. 21, 2015.
 U.S. Appl. No. 14/589,277, Parsons et al., "Golf Club Heads and Methods to Manufacture Golf Club Heads," filed Jan. 5, 2015.
 U.S. Appl. No. 29/512,313, Nicolette, "Golf Club Head," filed Dec. 18, 2014.

(56)

References Cited

OTHER PUBLICATIONS

U.S. Appl. No. 14/618,501, Parsons et al., "Golf Club Heads and Methods to Manufacture Golf Club Heads," filed Feb. 10, 2015.

* cited by examiner

Primary Examiner — Mitchell Siegel

(57)

CLAIM

The ornamental design for a golf club head, as shown and described.

DESCRIPTION

FIG. 1 is a top perspective view of a golf club head;
FIG. 2 is a bottom perspective view of the golf club head of FIG. 1;
FIG. 3 is a front elevational view of the golf club head of FIG. 1;
FIG. 4 is a rear elevational view of the golf club head of FIG. 1;
FIG. 5 is a top view of the golf club head of FIG. 1;
FIG. 6 is a bottom view of the golf club head of FIG. 1;
FIG. 7 is a left side view of the golf club head of FIG. 1;
FIG. 8 is a right side view of the golf club head of FIG. 1;
FIG. 9 is a top perspective view of a second embodiment of a golf club head;
FIG. 10 is a bottom perspective view of the golf club head of FIG. 9;
FIG. 11 is a front elevational view of the golf club head of FIG. 9;
FIG. 12 is a rear elevational view of the golf club head of FIG. 9;

FIG. 13 is a top view of the golf club head of FIG. 9;
FIG. 14 is a bottom view of the golf club head of FIG. 9;
FIG. 15 is a left side view of the golf club head of FIG. 9;
FIG. 16 is a right side view of the golf club head of FIG. 9;
FIG. 17 is a top perspective view of a third embodiment of a golf club head;
FIG. 18 is a bottom perspective view of the golf club head of FIG. 17;
FIG. 19 is a front elevational view of the golf club head of FIG. 17;
FIG. 20 is a rear elevational view of the golf club head of FIG. 17;
FIG. 21 is a top view of the golf club head of FIG. 17;
FIG. 22 is a bottom view of the golf club head of FIG. 17;
FIG. 23 is a left side view of the golf club head of FIG. 17;
FIG. 24 is a right side view of the golf club head of FIG. 17;
FIG. 25 is a top perspective view of a fourth embodiment of a golf club head;
FIG. 26 is a bottom perspective view of the golf club head of FIG. 25;
FIG. 27 is a front elevational view of the golf club head of FIG. 25;
FIG. 28 is a rear elevational view of the golf club head of FIG. 25;
FIG. 29 is a top view of the golf club head of FIG. 25;
FIG. 30 is a bottom view of the golf club head of FIG. 25;
FIG. 31 is a left side view of the golf club head of FIG. 25;
and,
FIG. 32 is a right side view of the golf club head of FIG. 25.
The broken lines are included for the purpose of illustration only. None of the broken lines forms part of the claimed design.

1 Claim, 28 Drawing Sheets

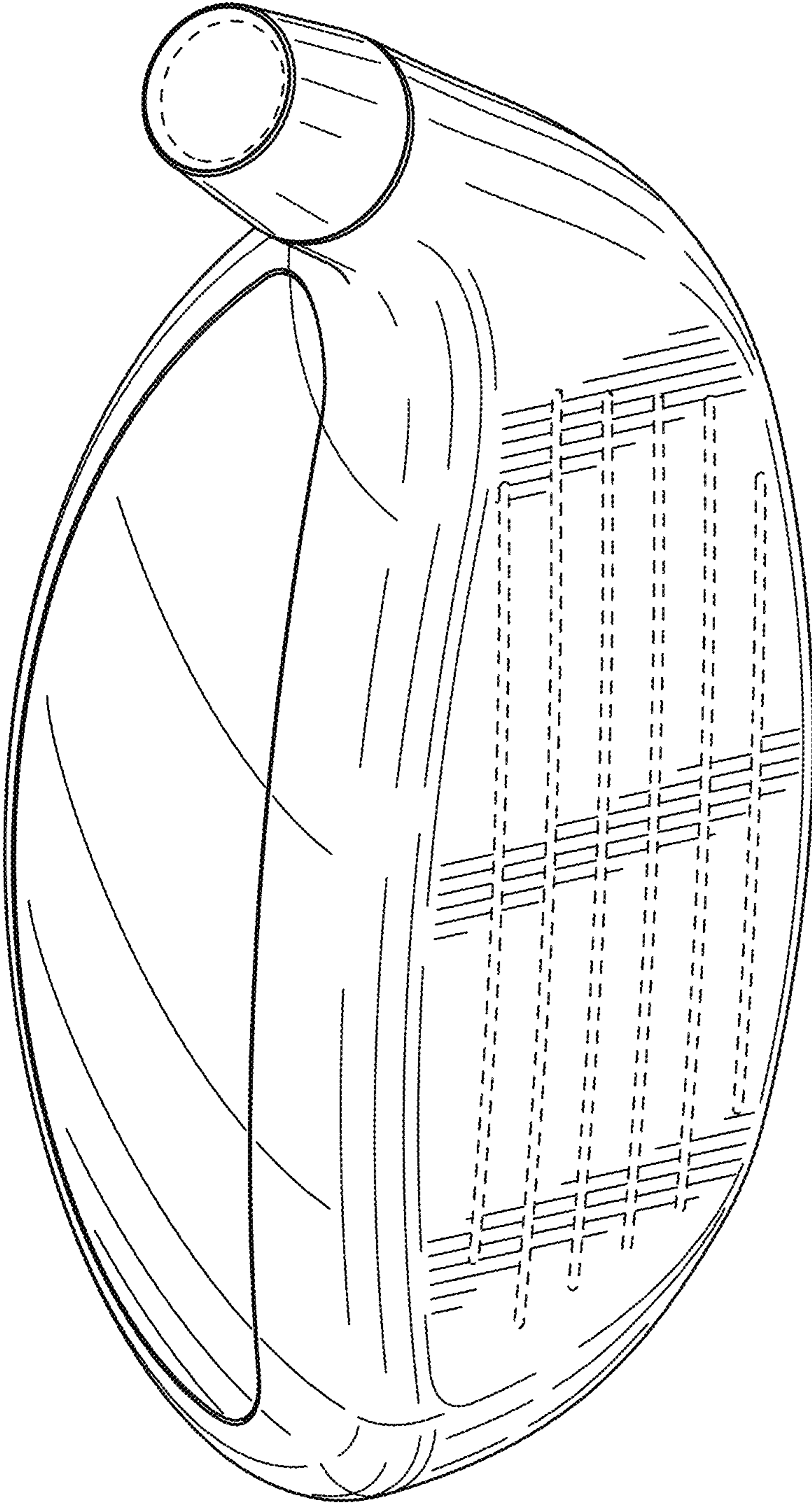

FIG. 1



FIG. 2

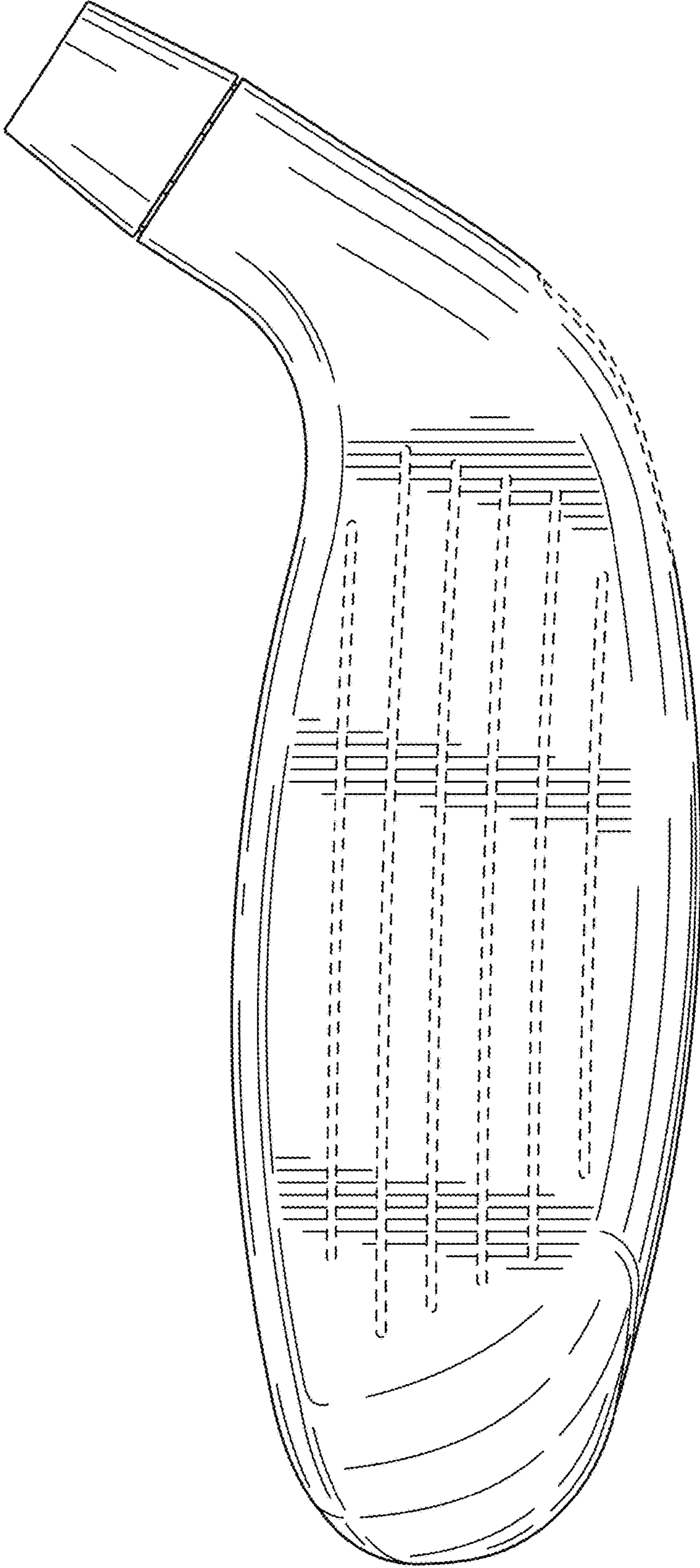

FIG. 3



FIG. 4

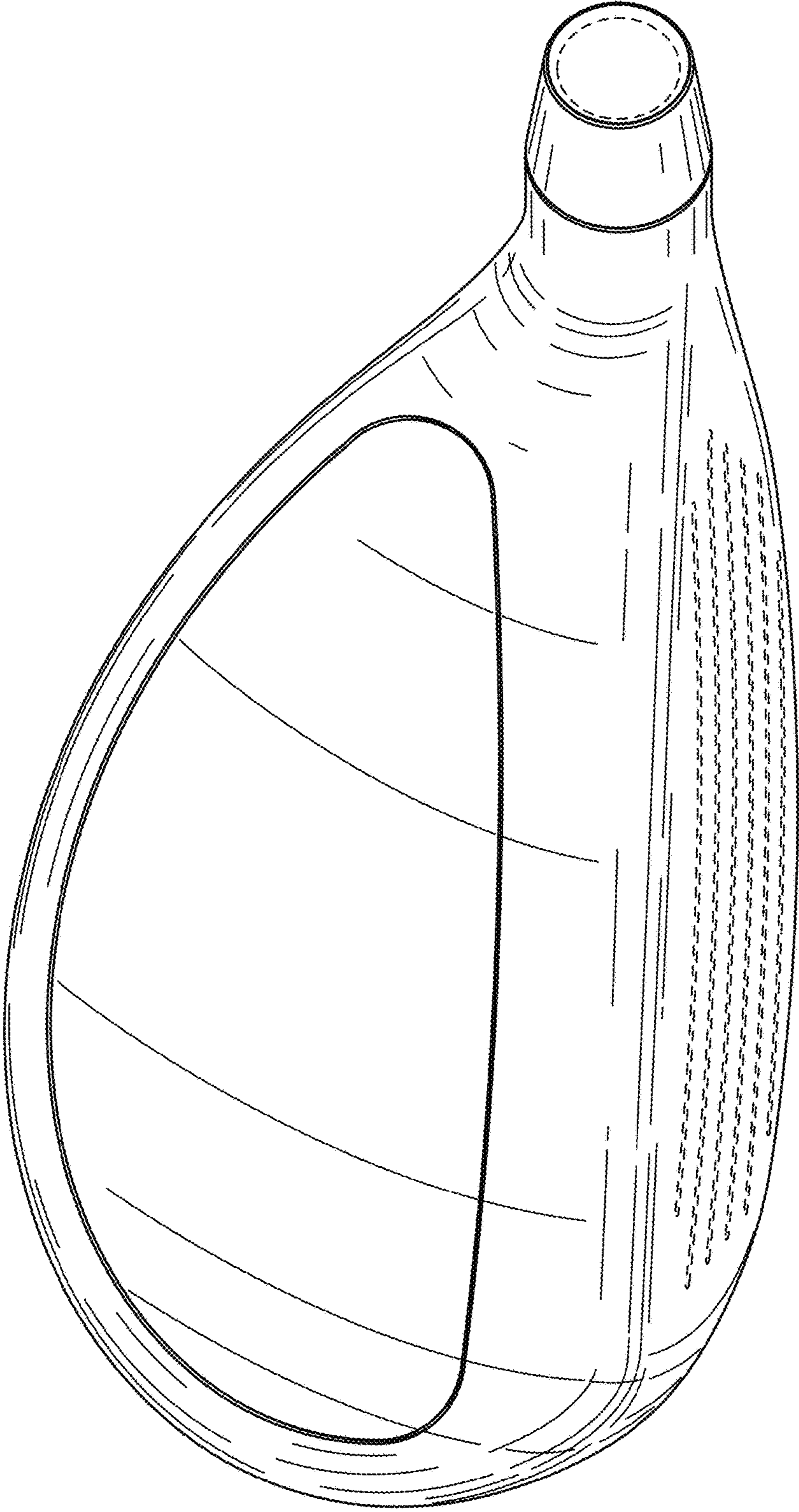

FIG. 5

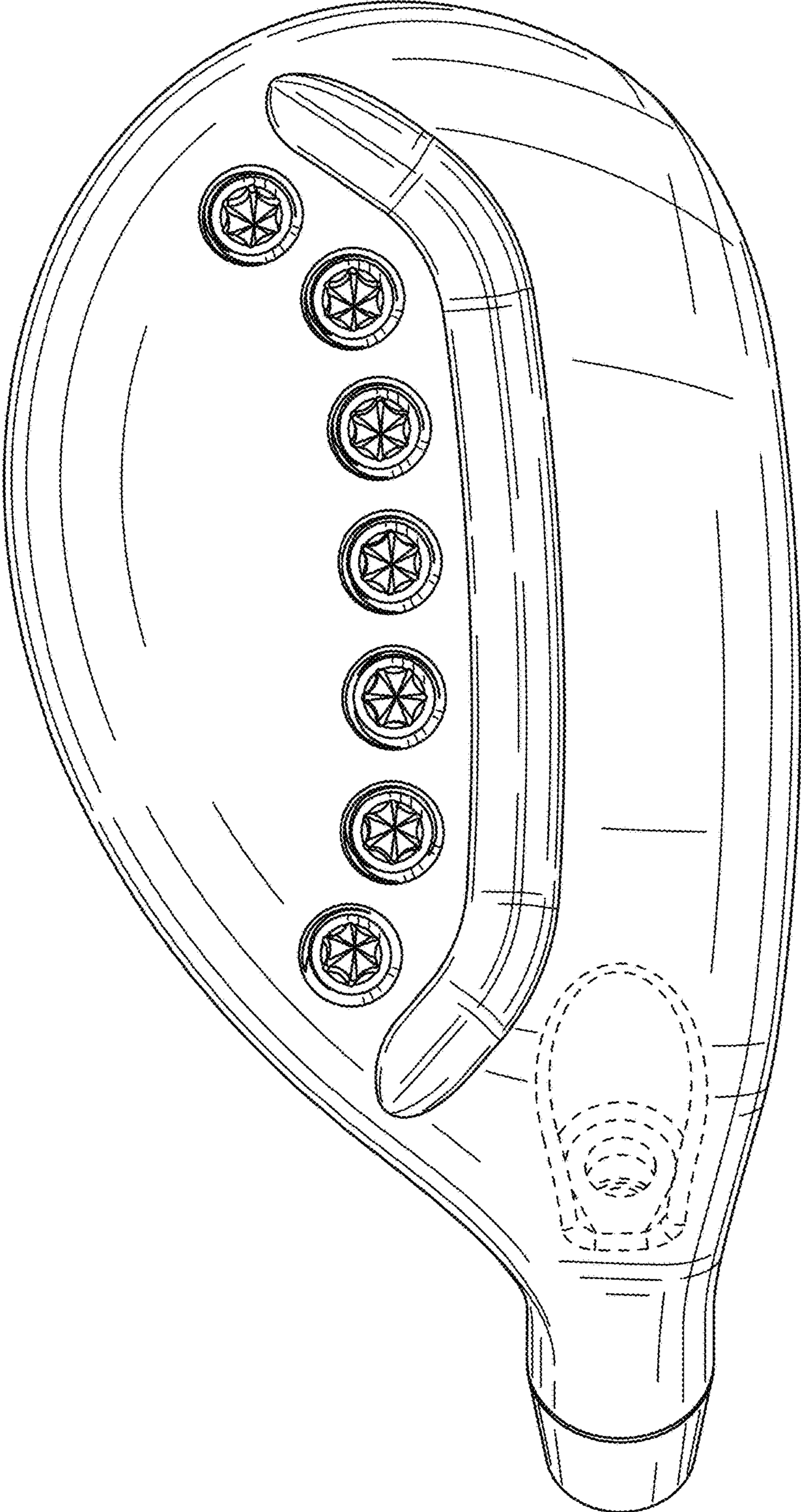

FIG. 6

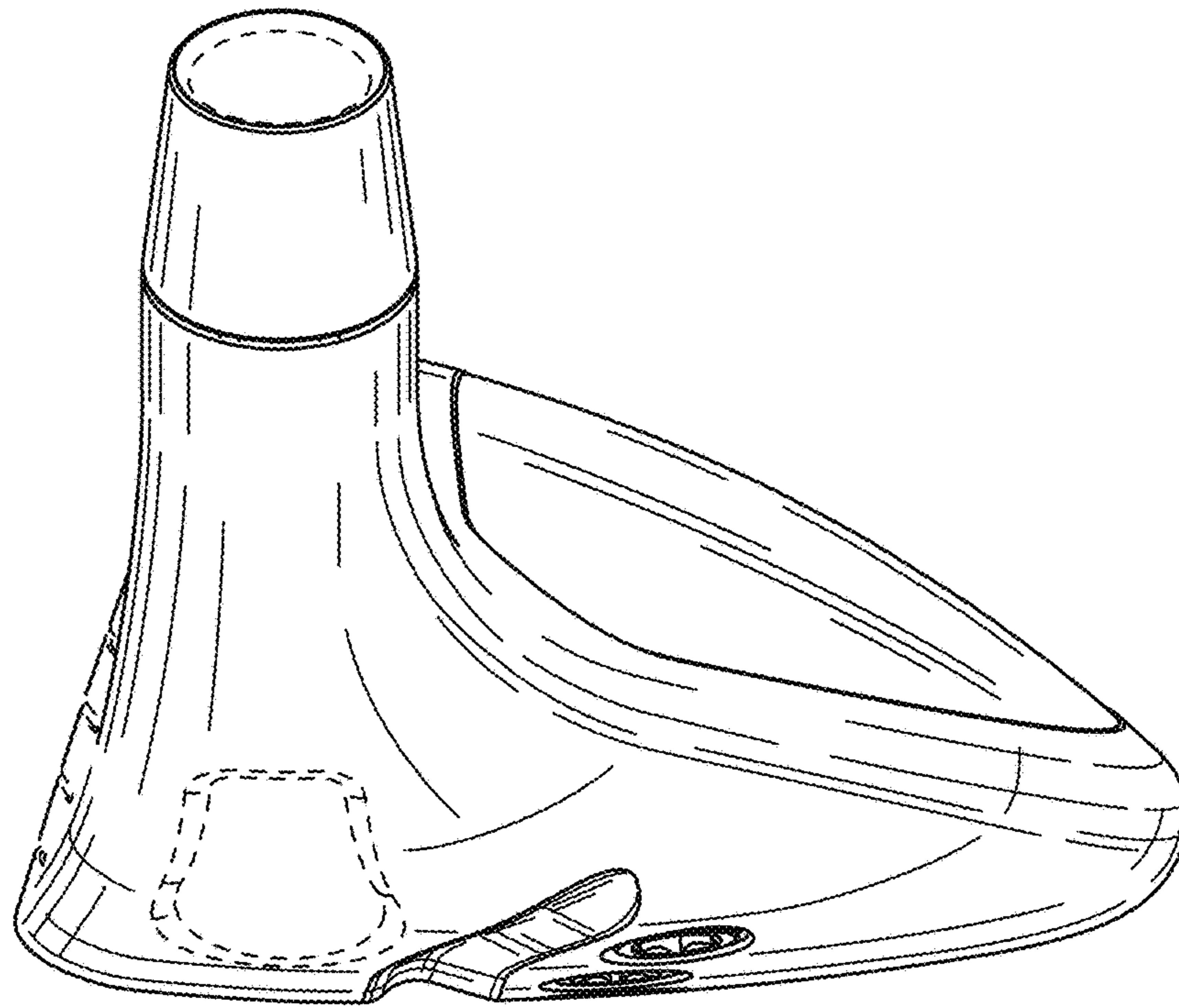

FIG. 7

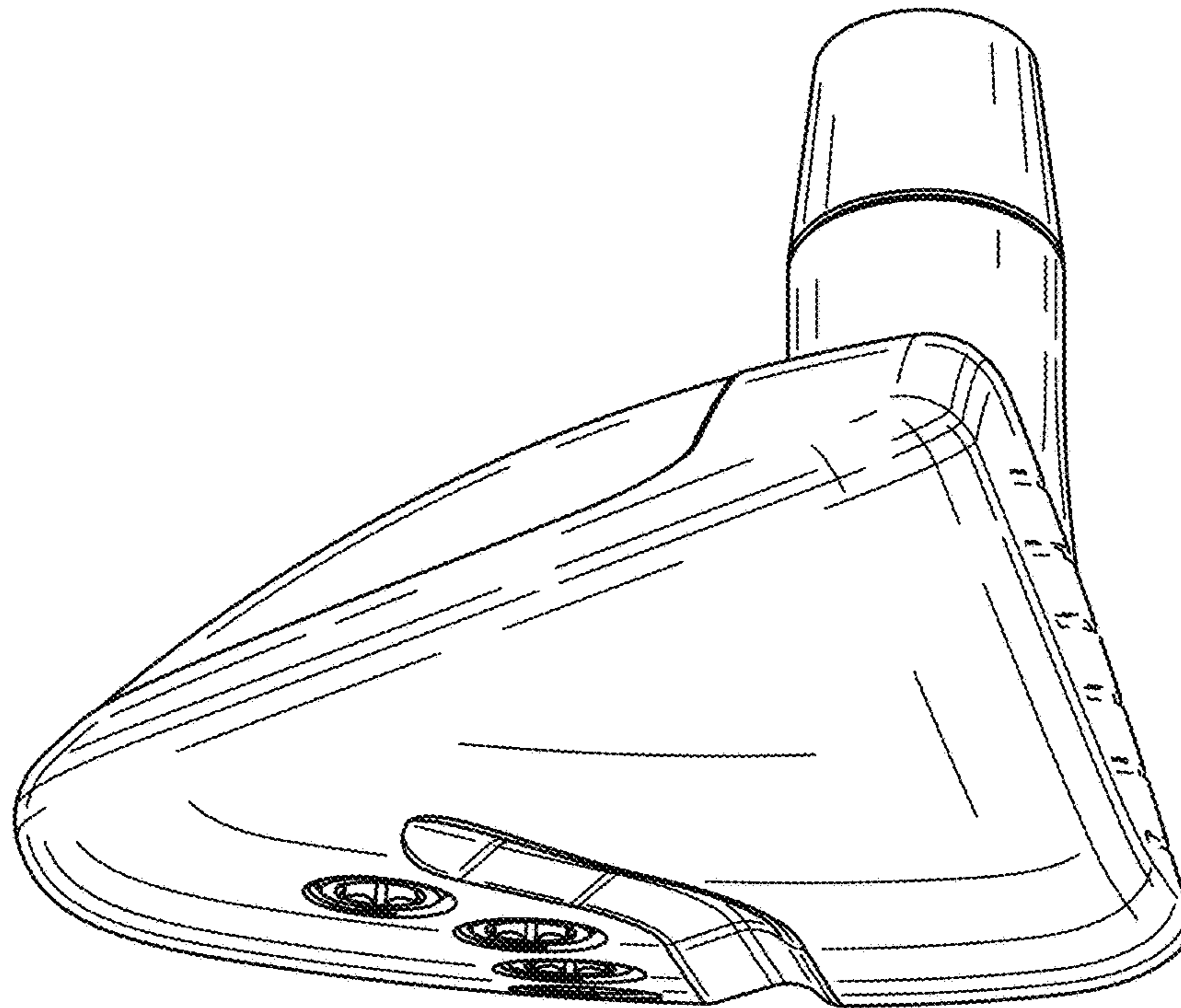

FIG. 8

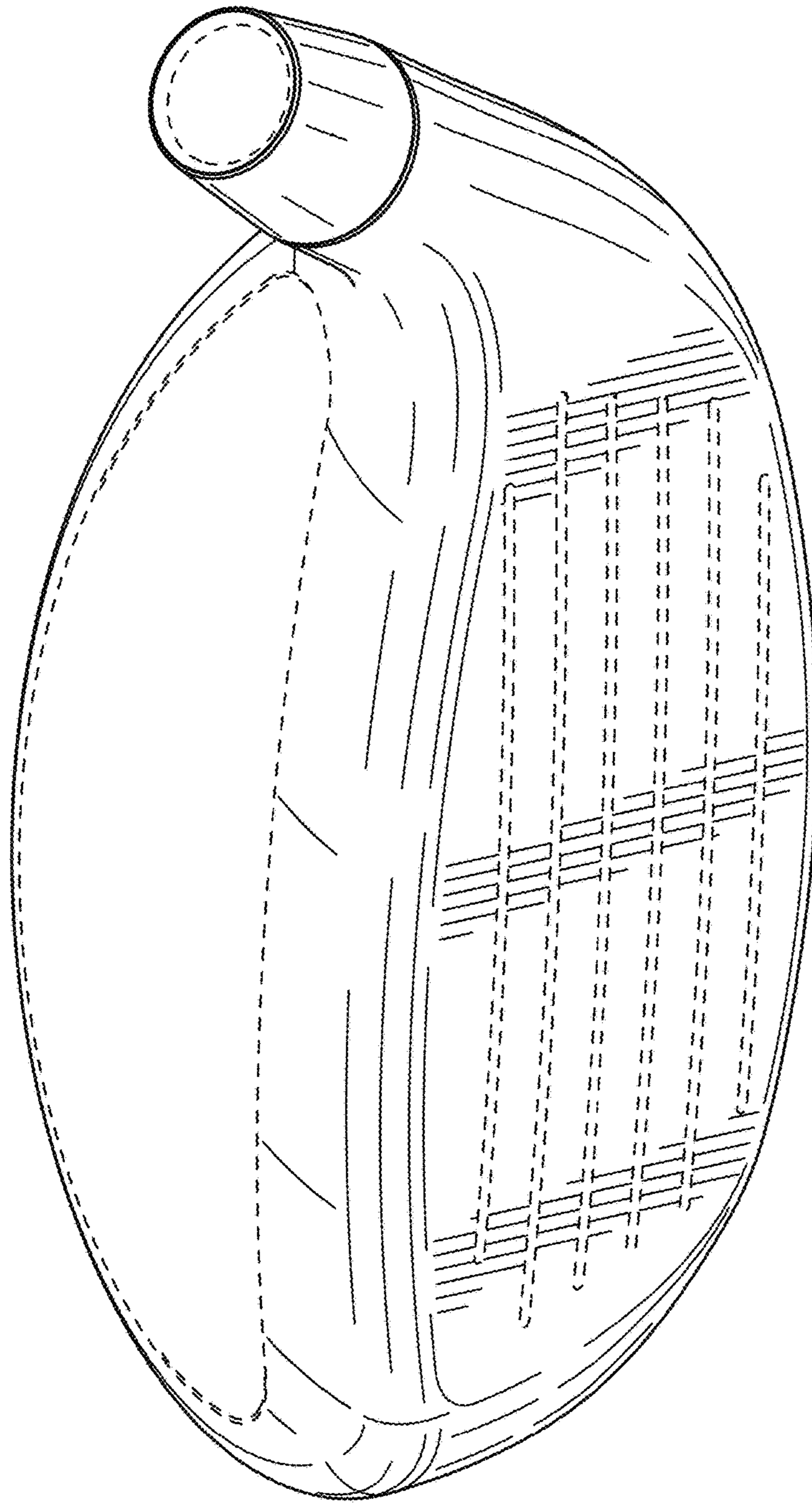

FIG. 9



FIG. 10

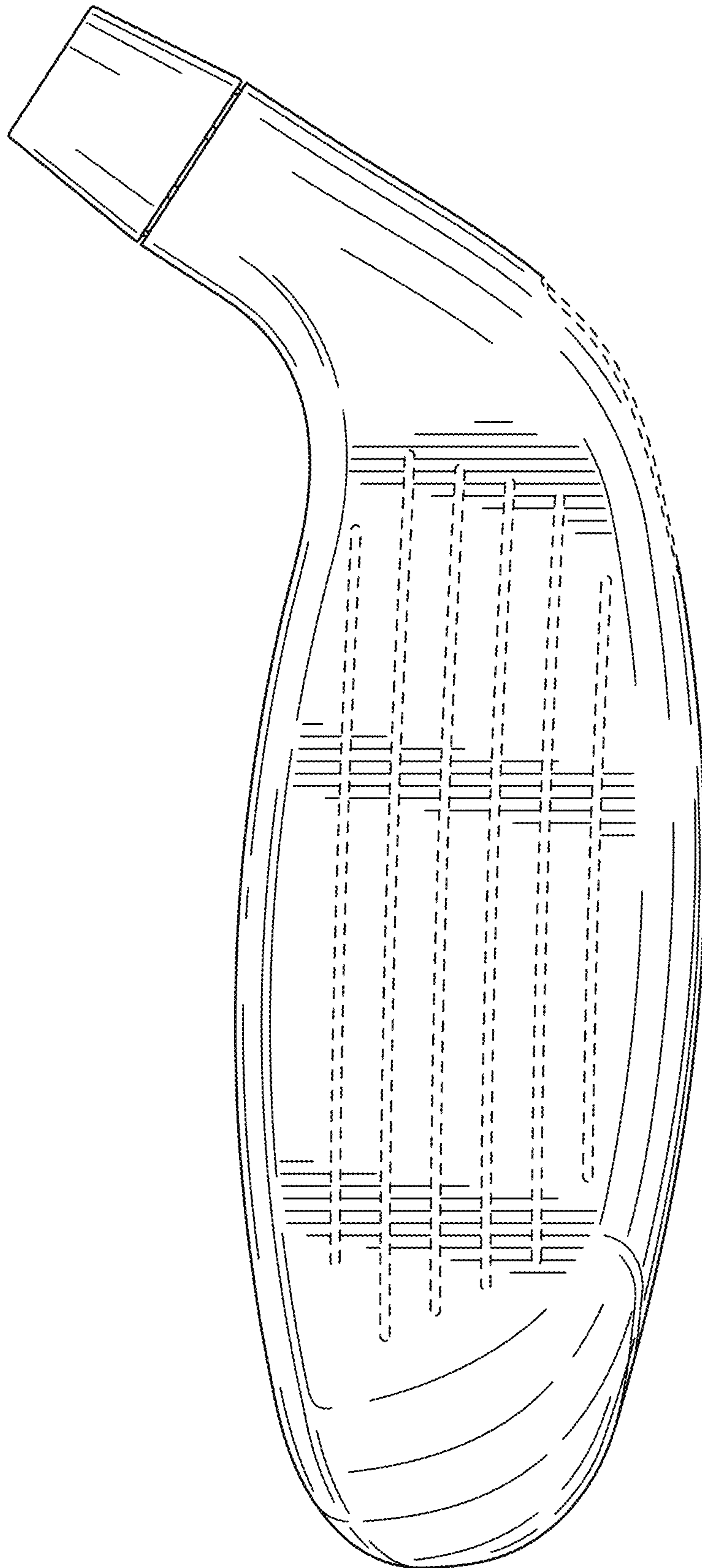

FIG. 11



FIG. 12

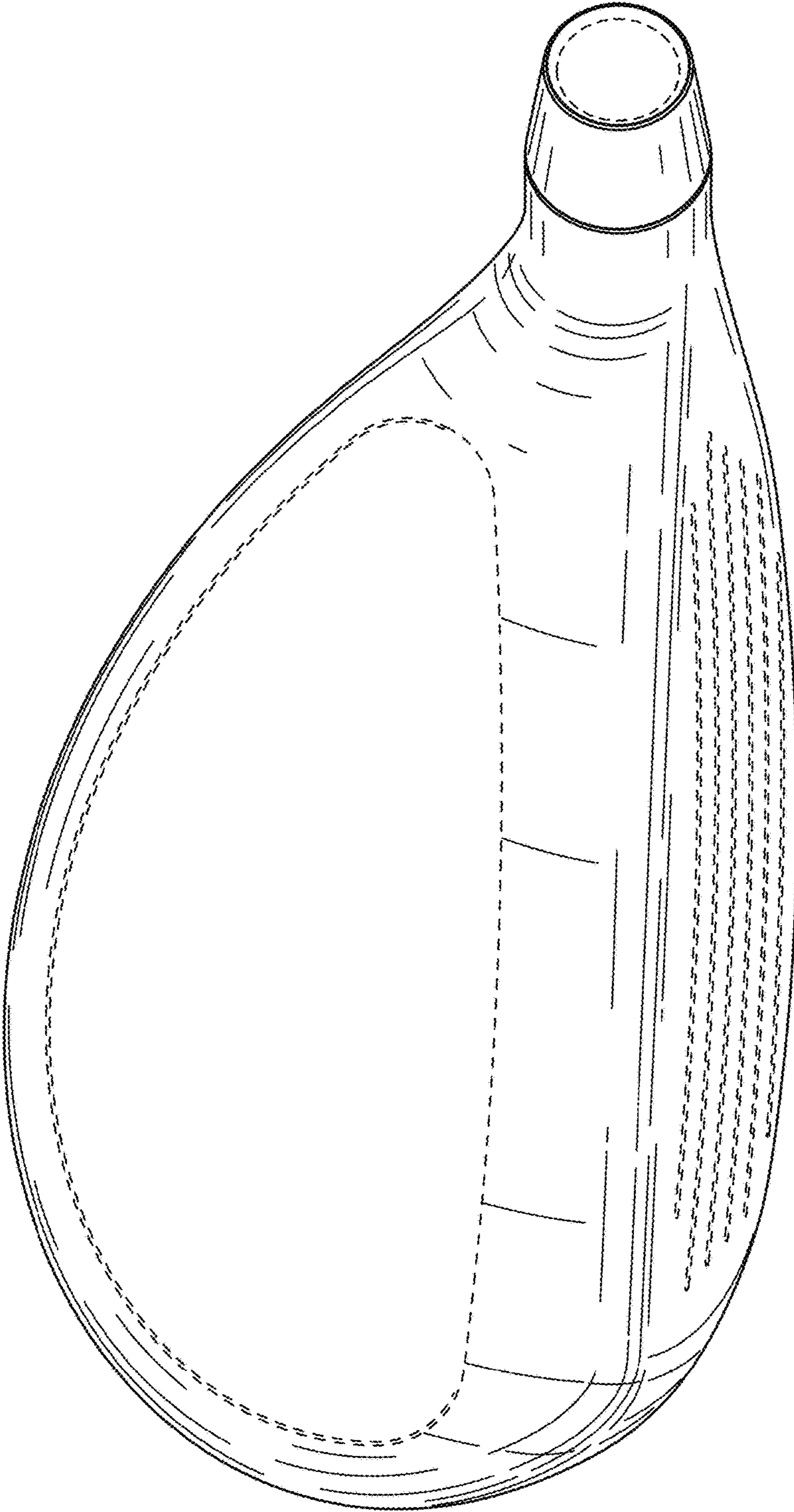

FIG. 13

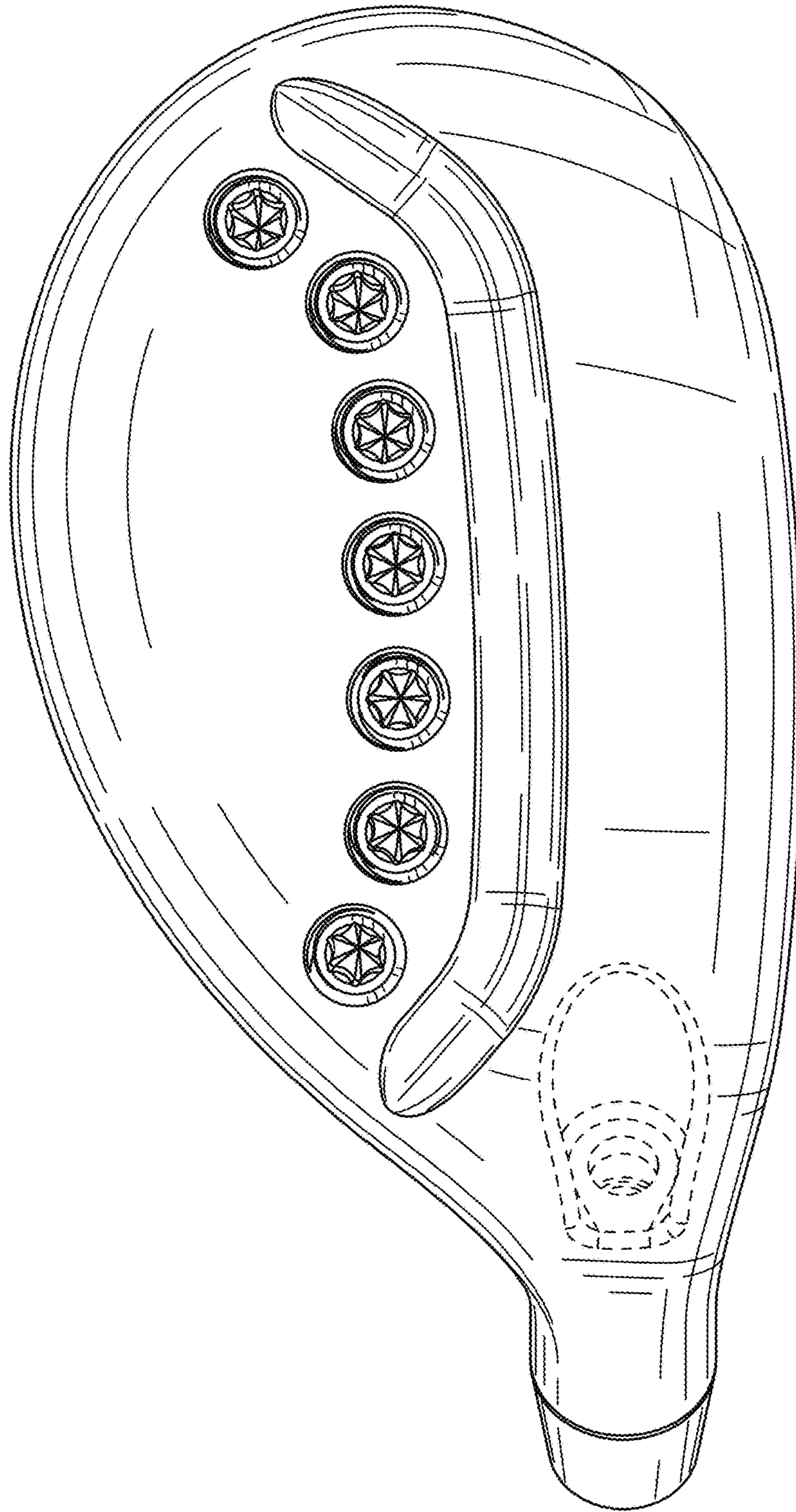

FIG. 14

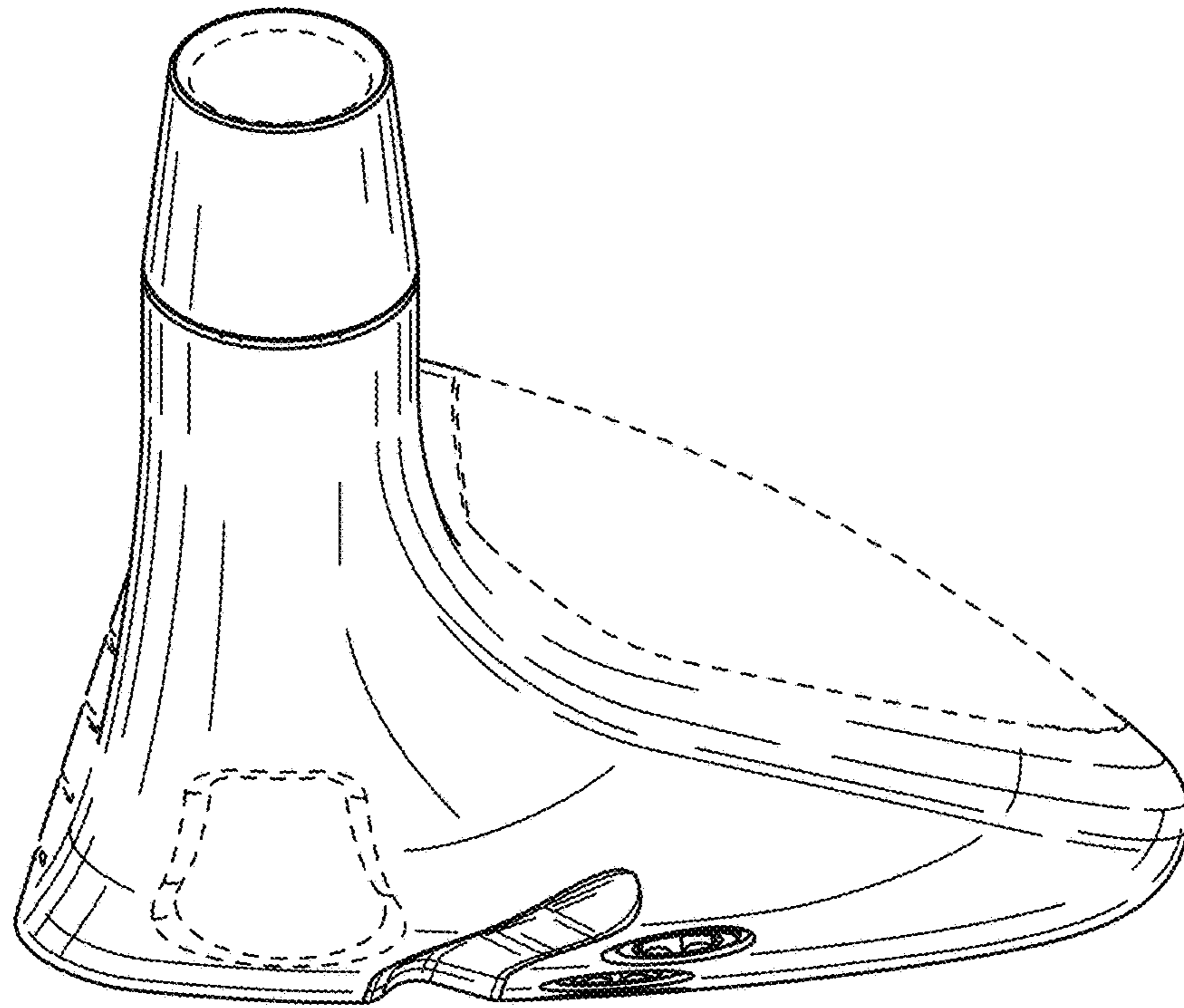

FIG. 15

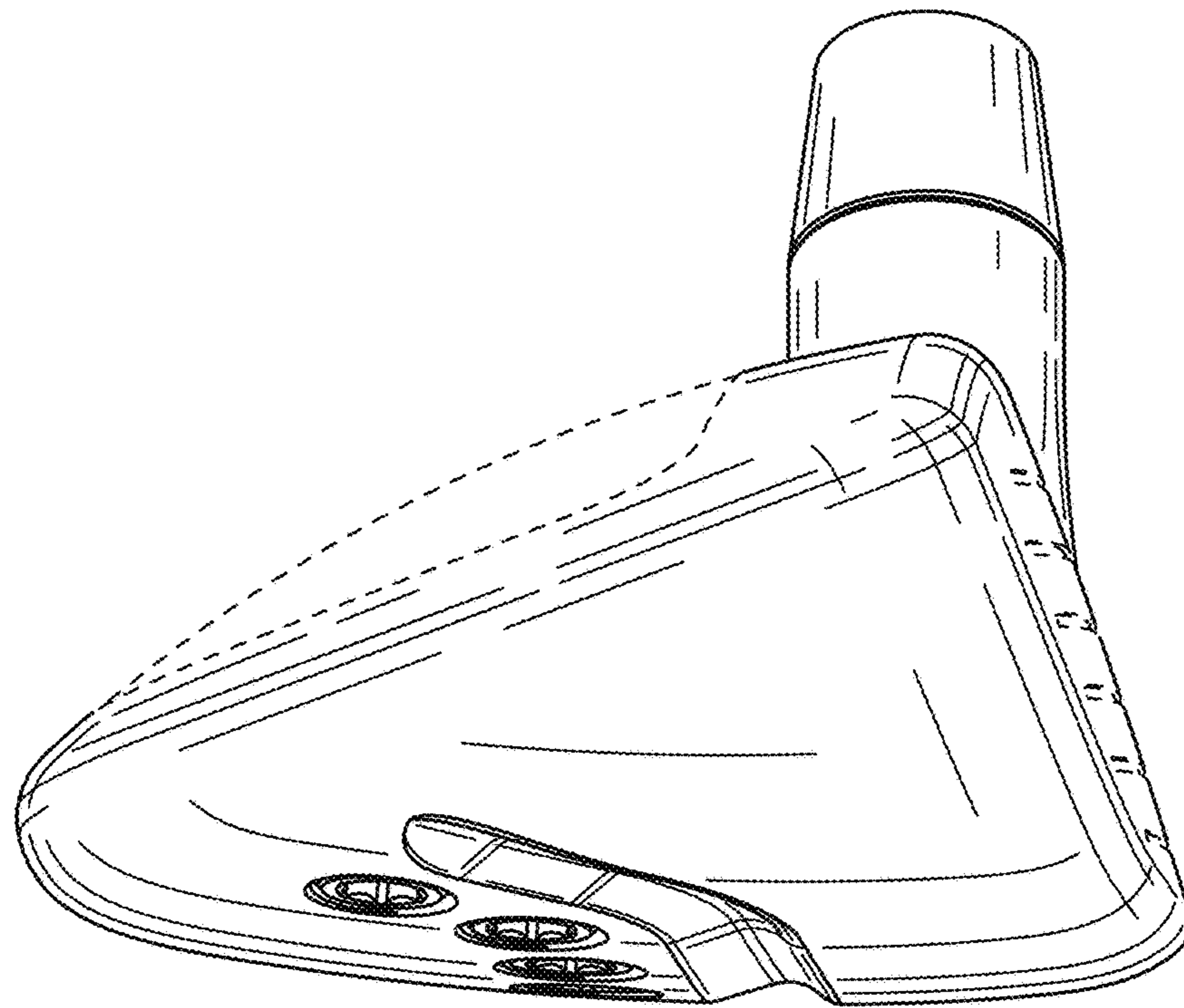

FIG. 16

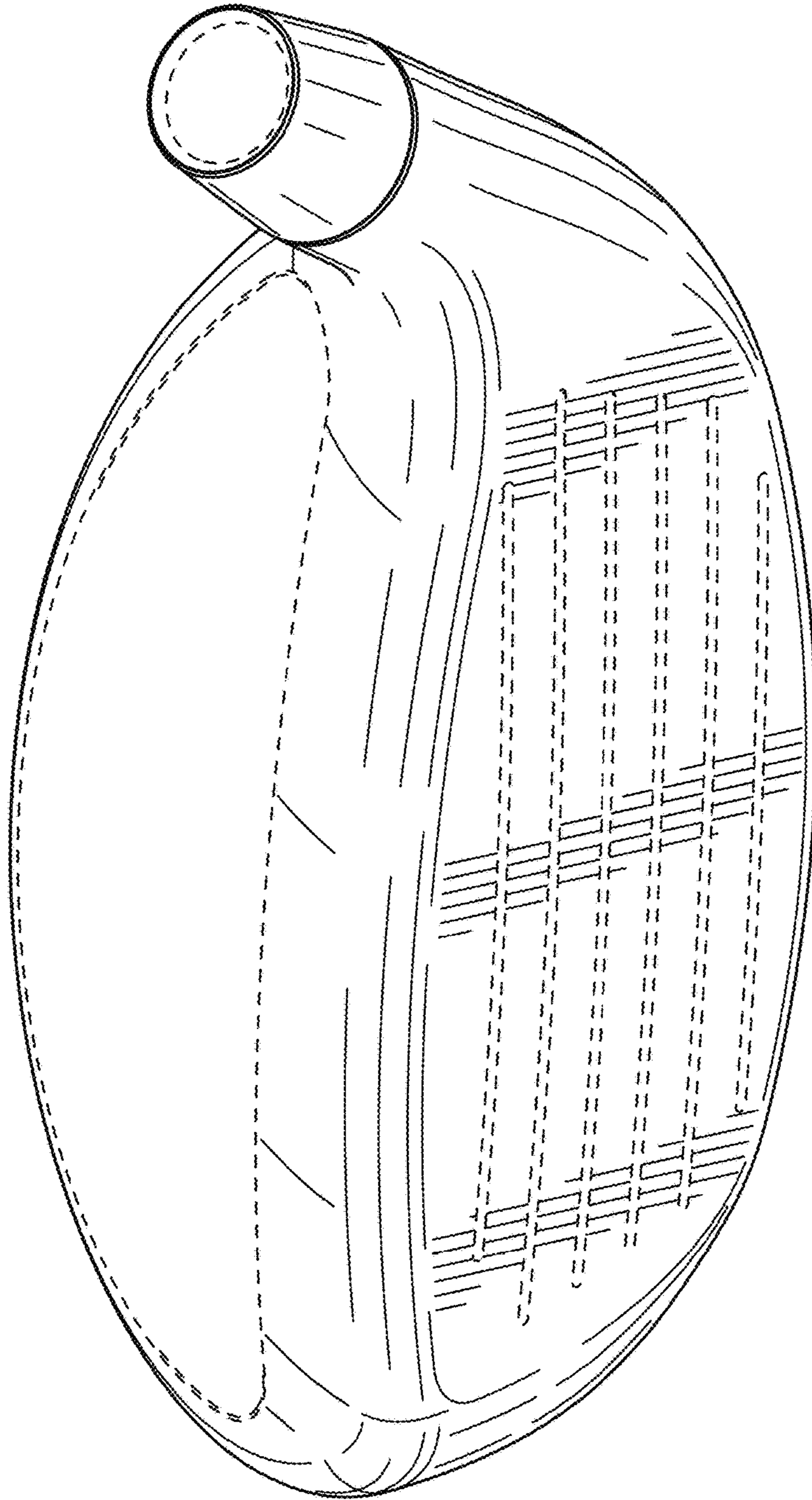

FIG. 17

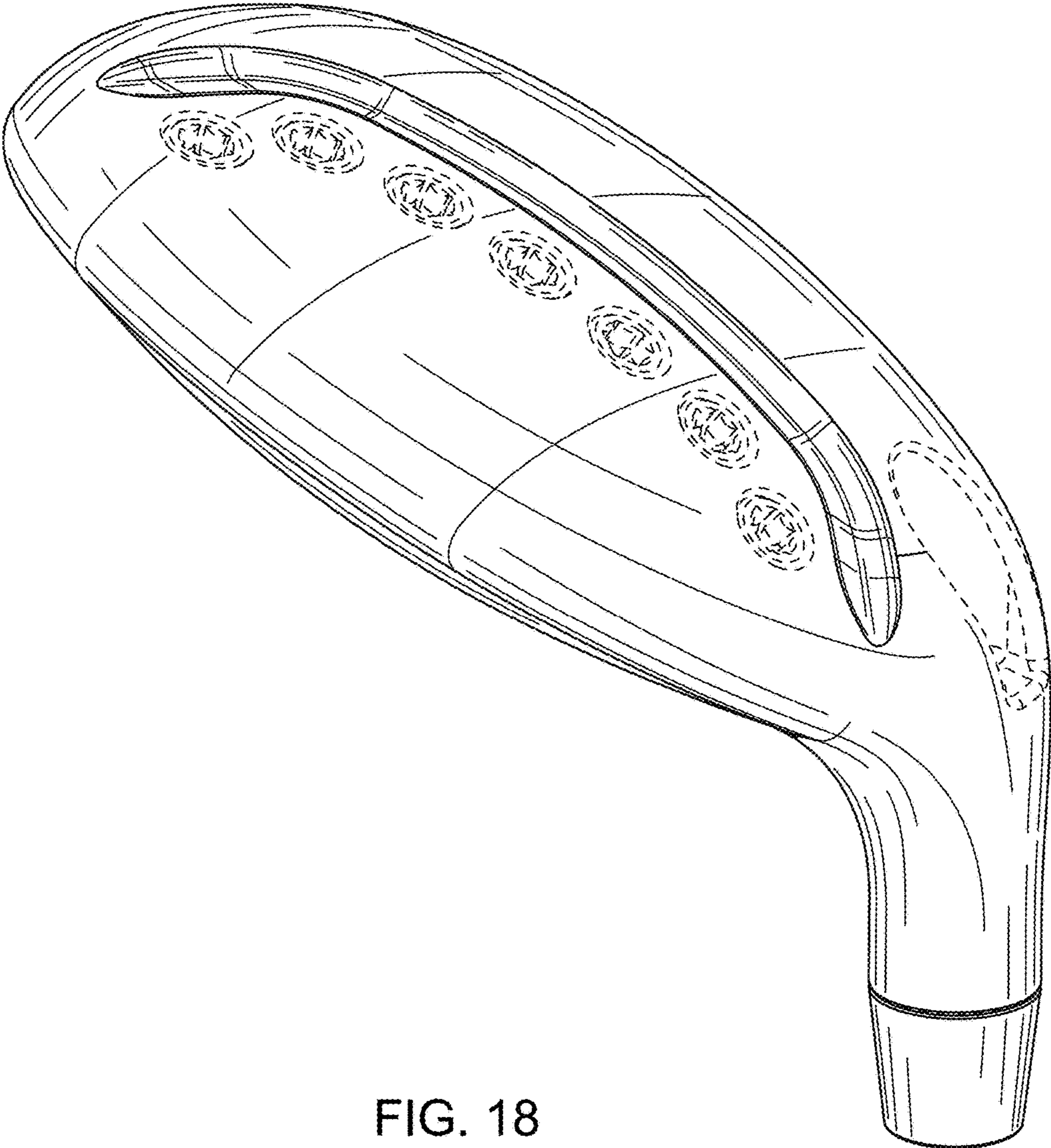

FIG. 18

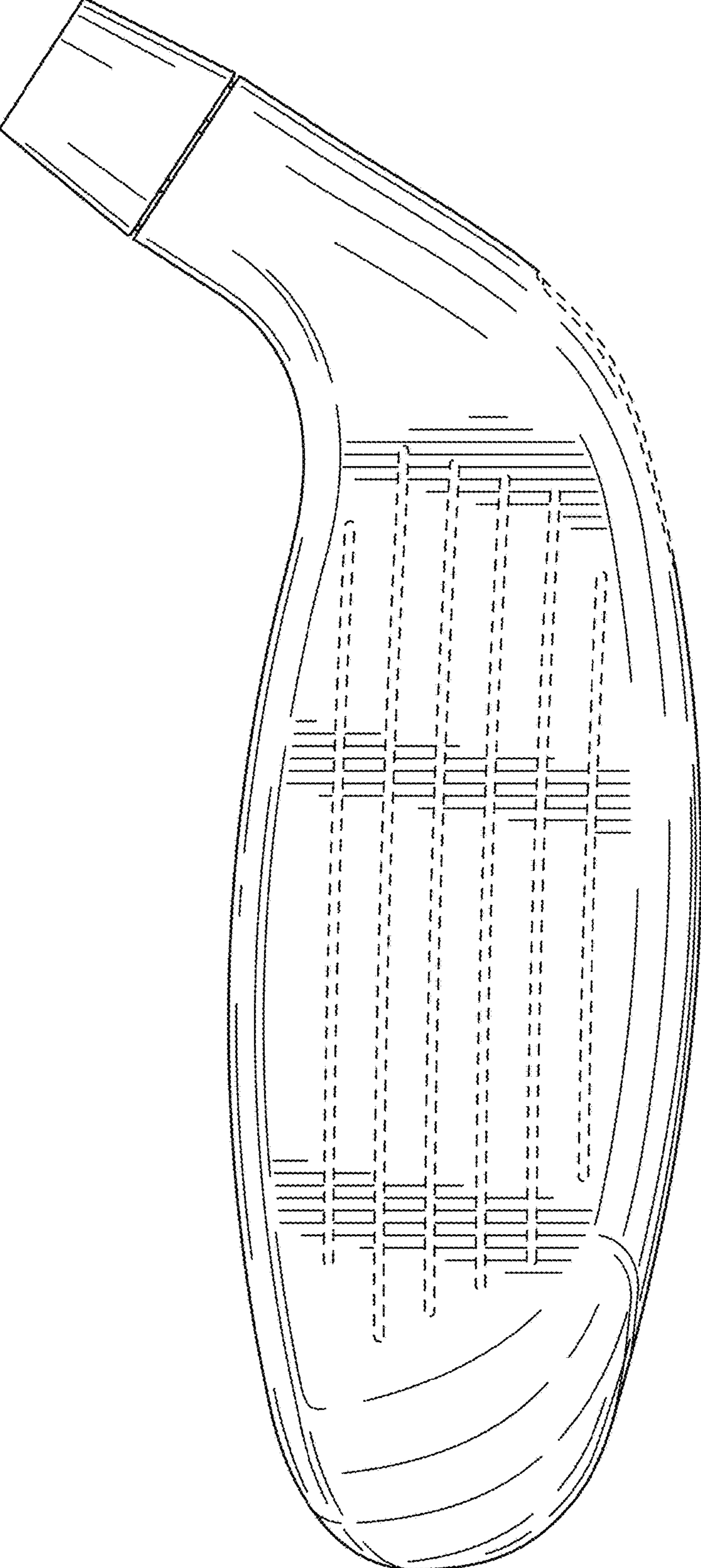

FIG. 19

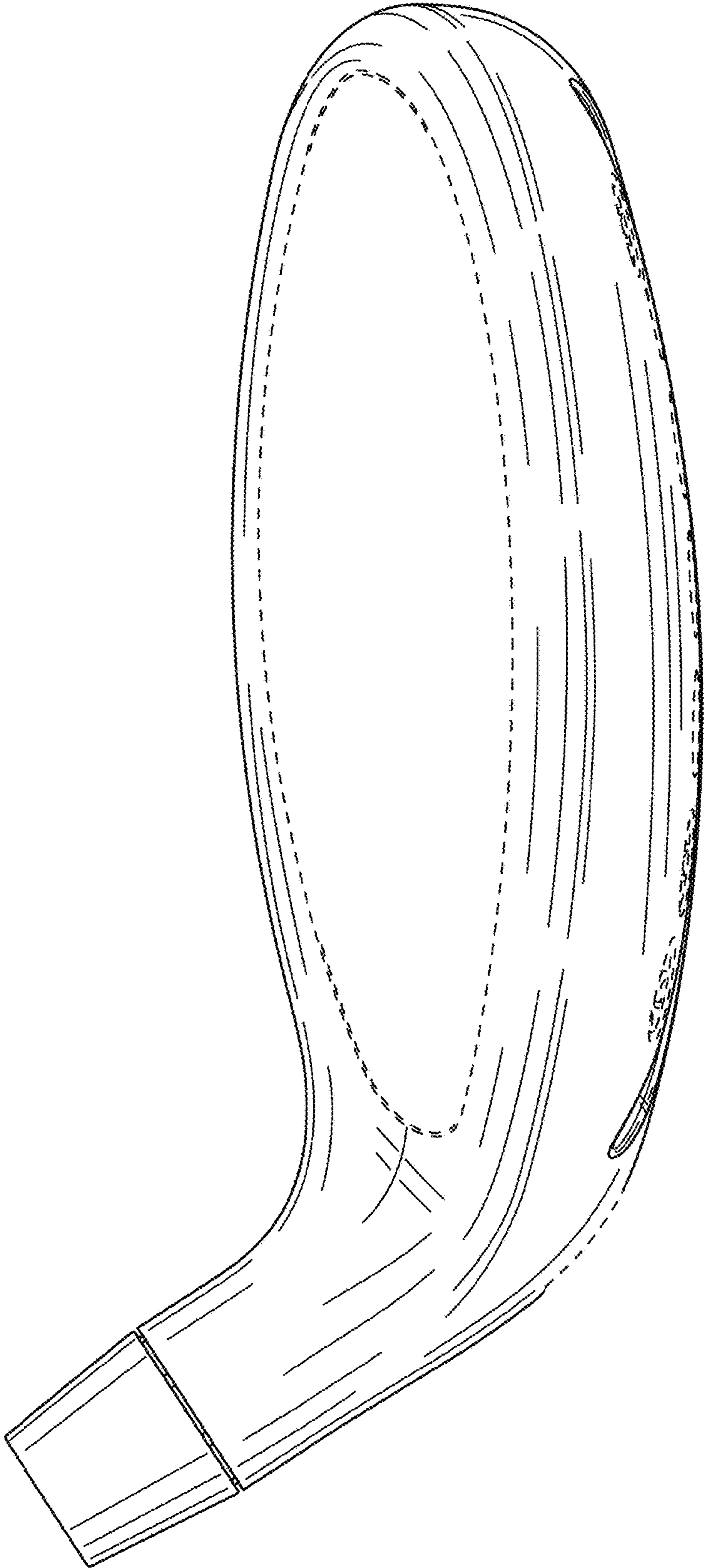

FIG. 20

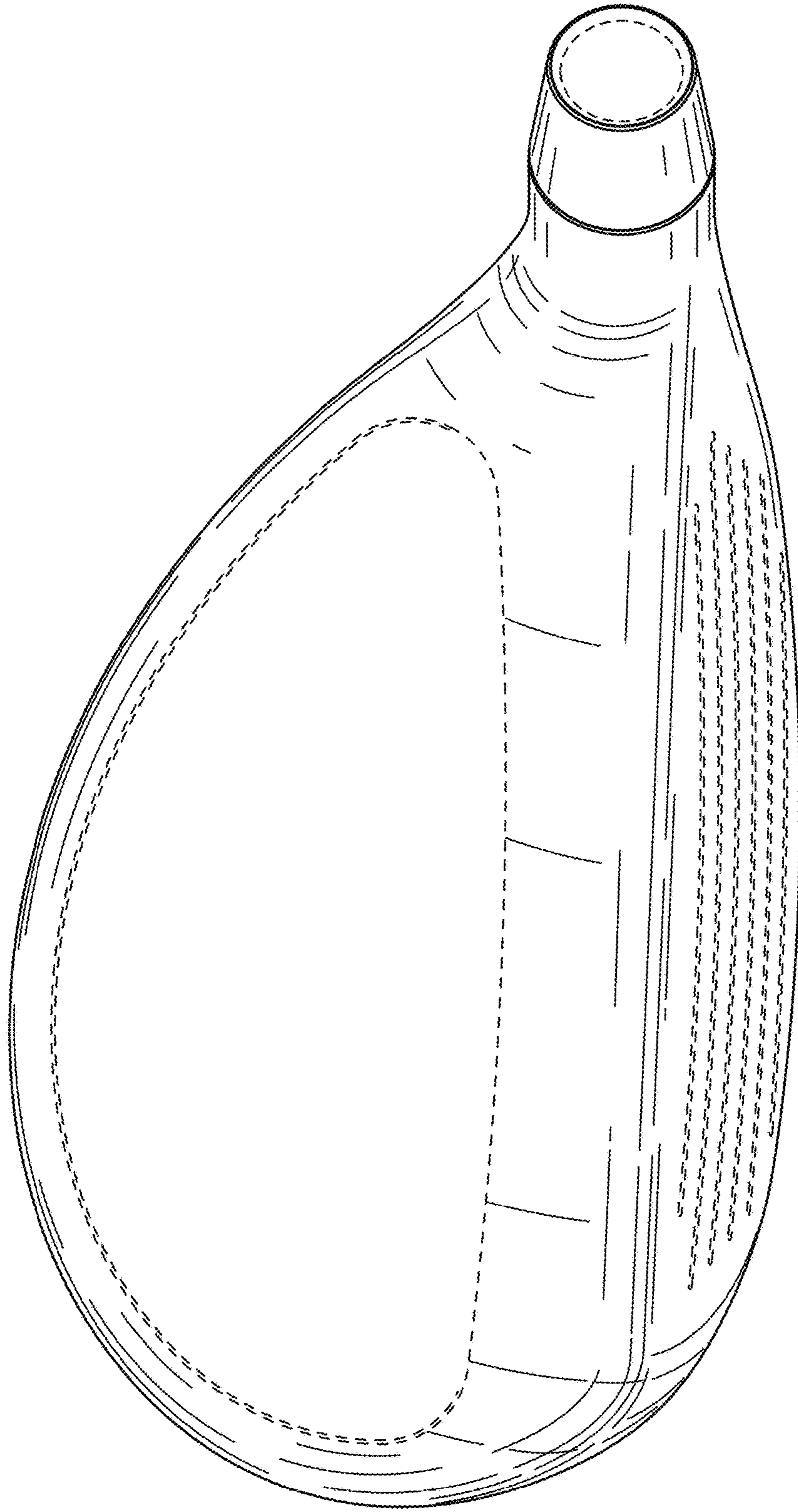

FIG. 21

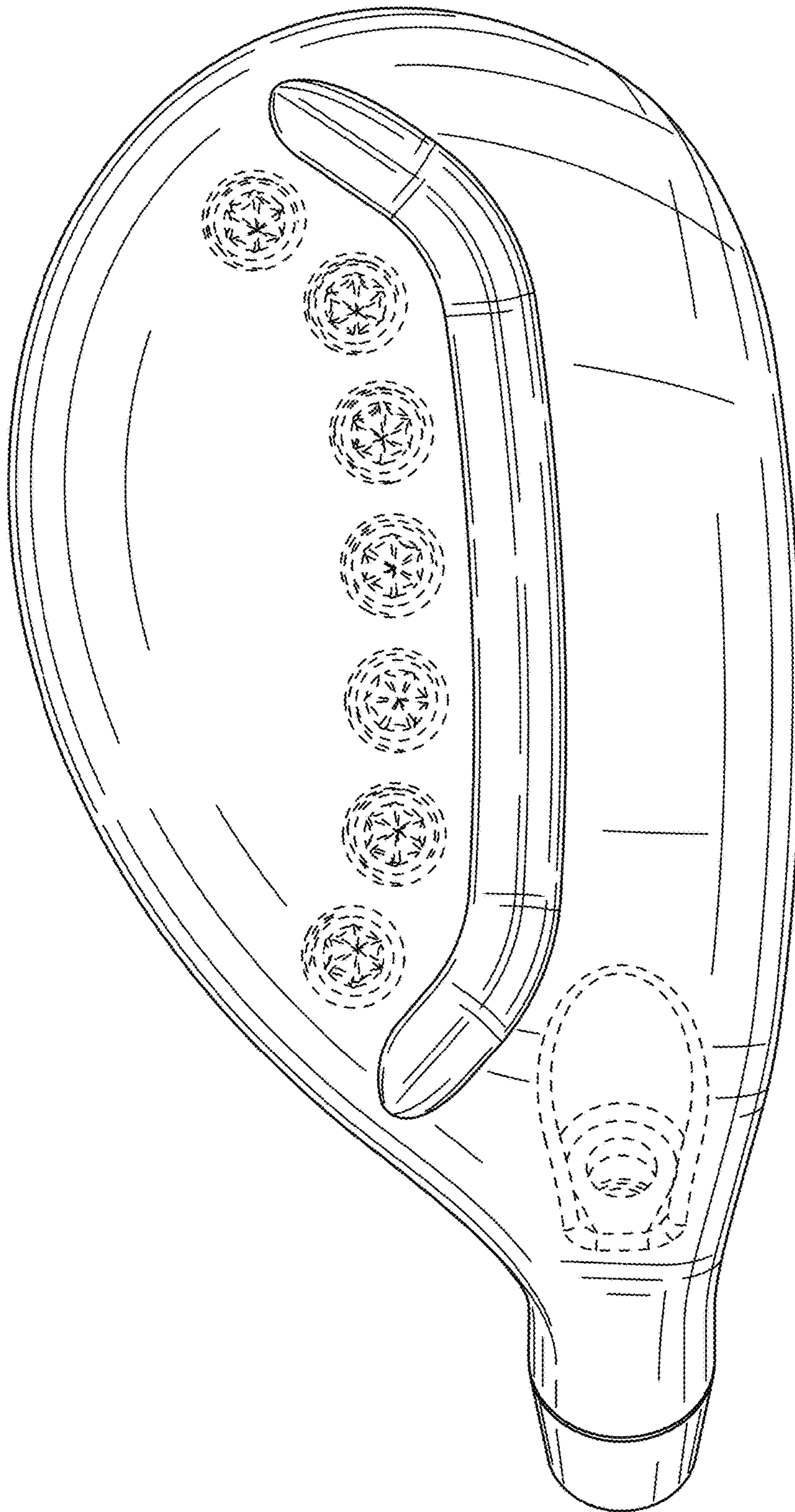

FIG. 22

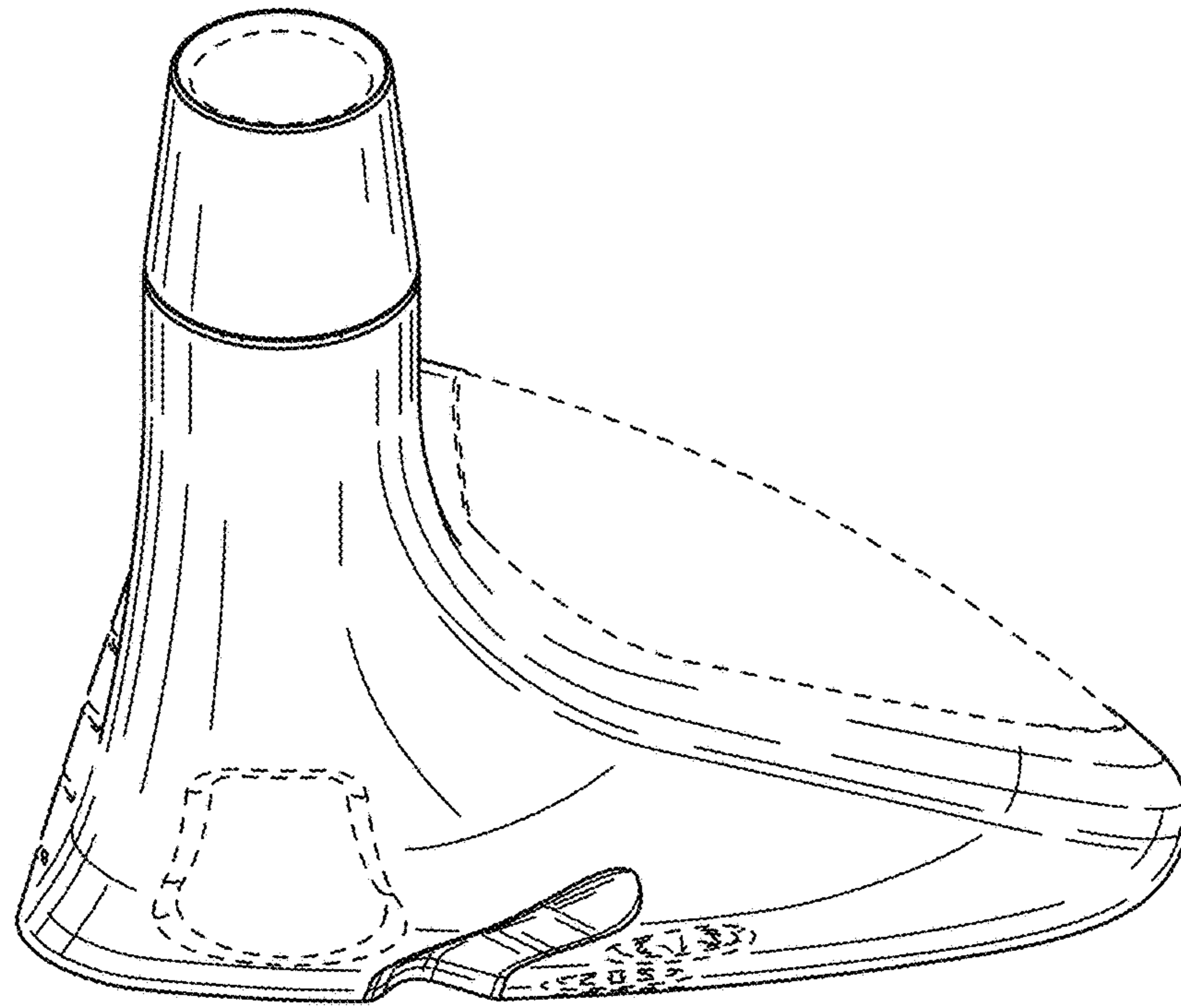

FIG. 23

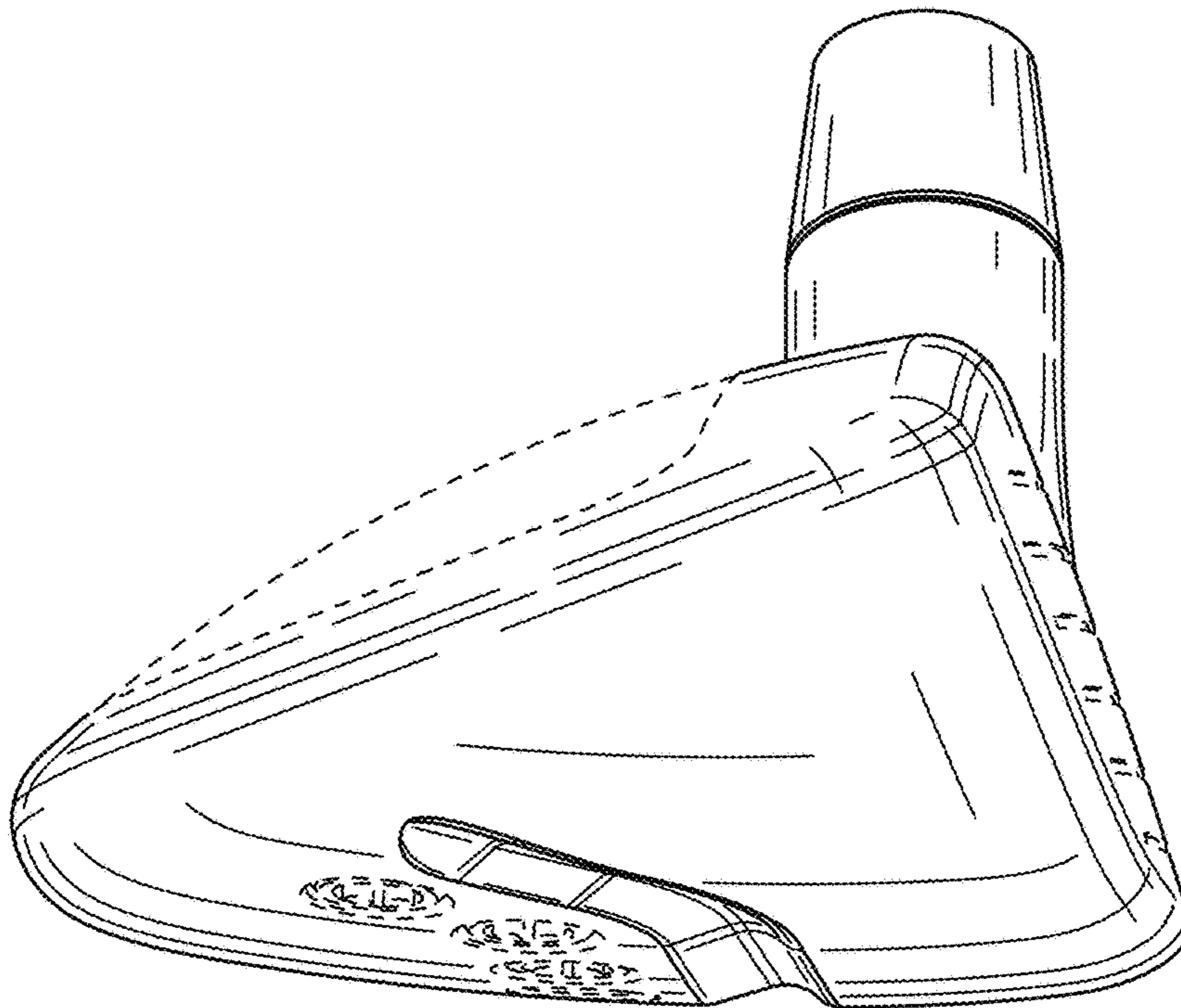

FIG. 24

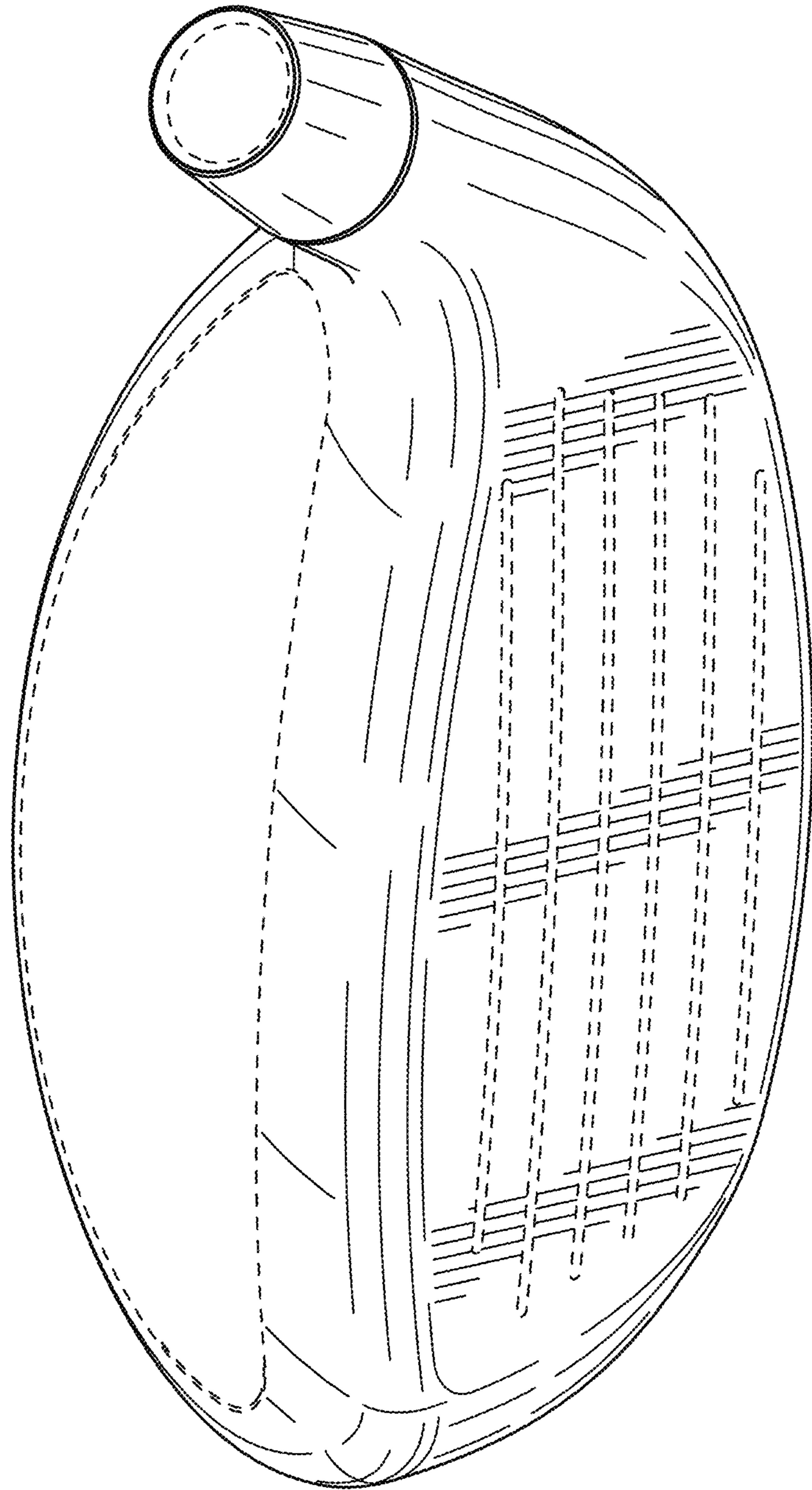

FIG. 25



FIG. 26

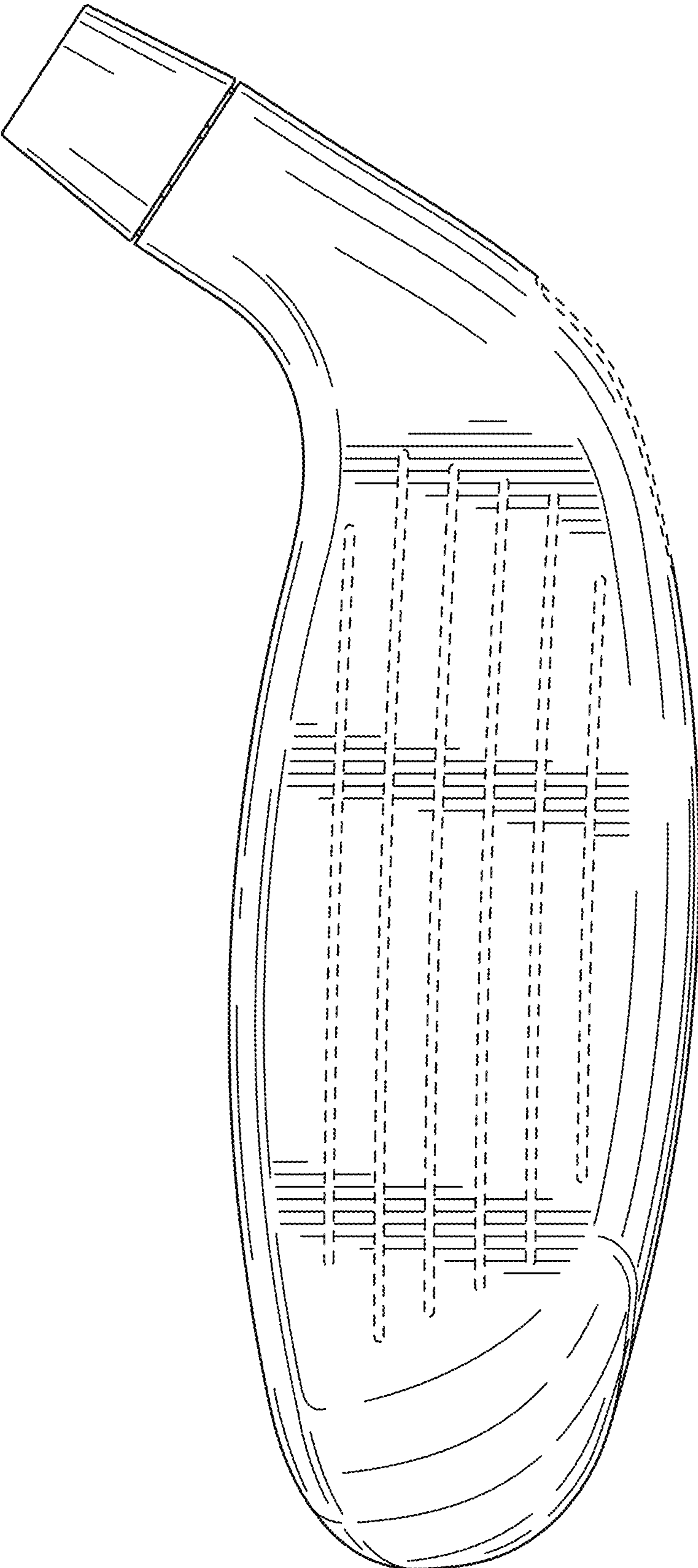

FIG. 27

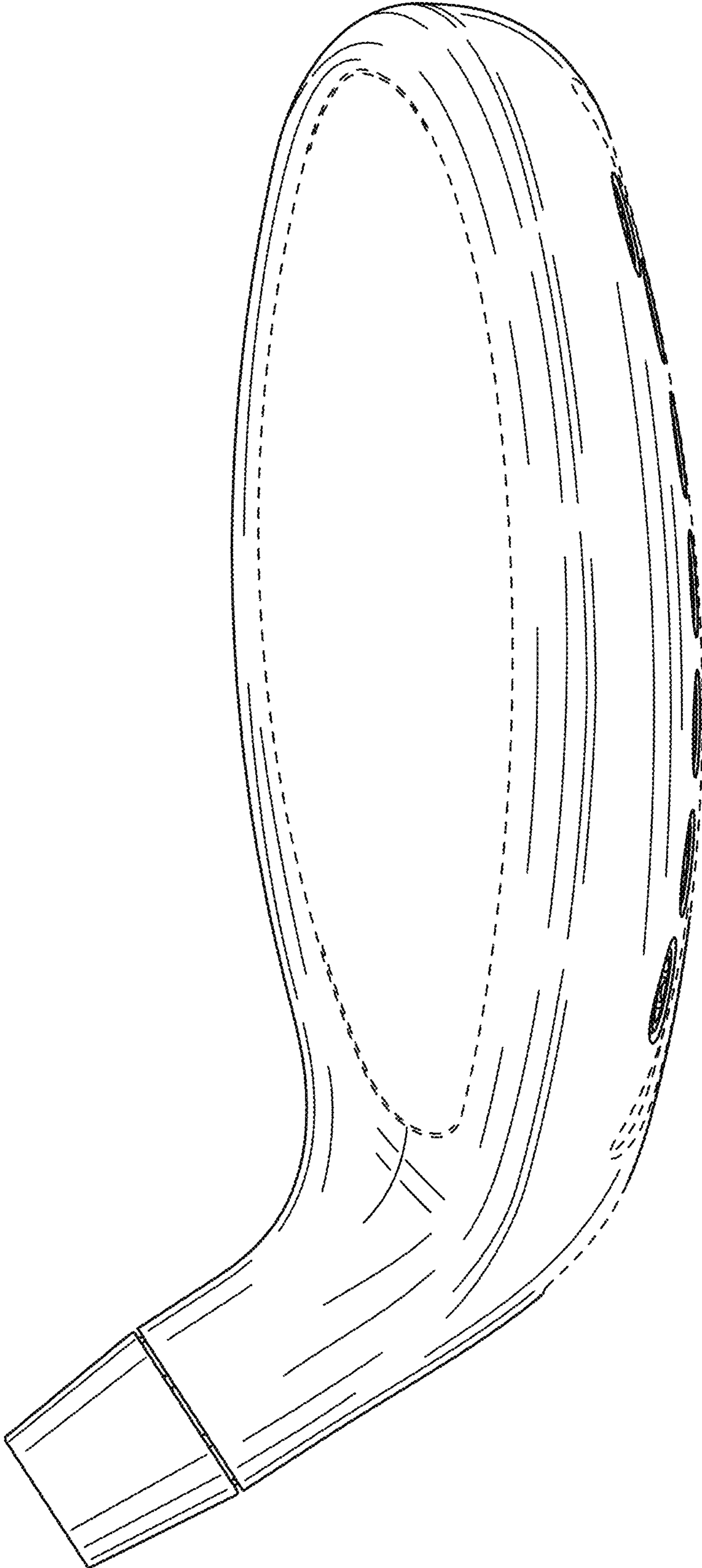

FIG. 28

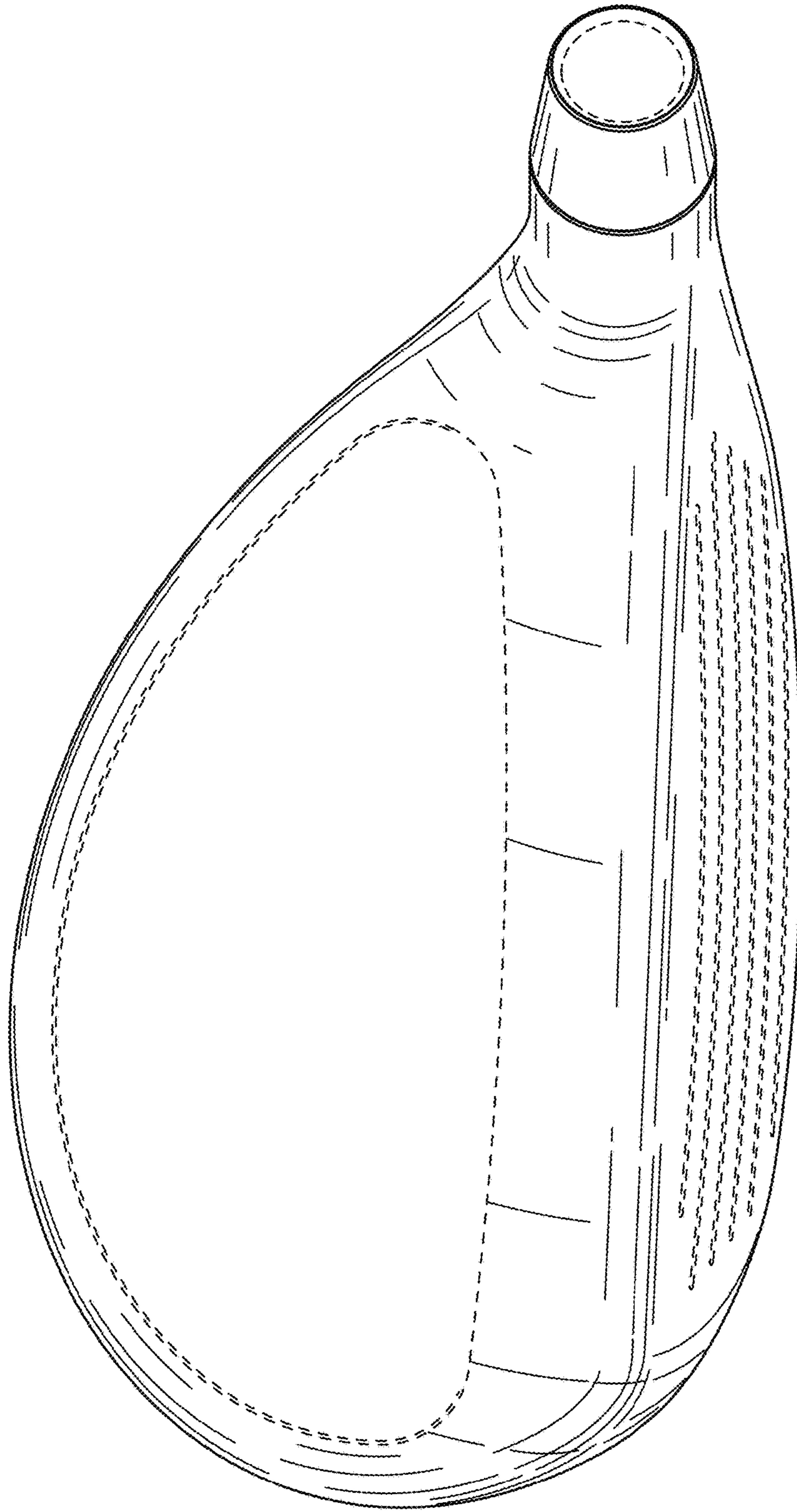

FIG. 29

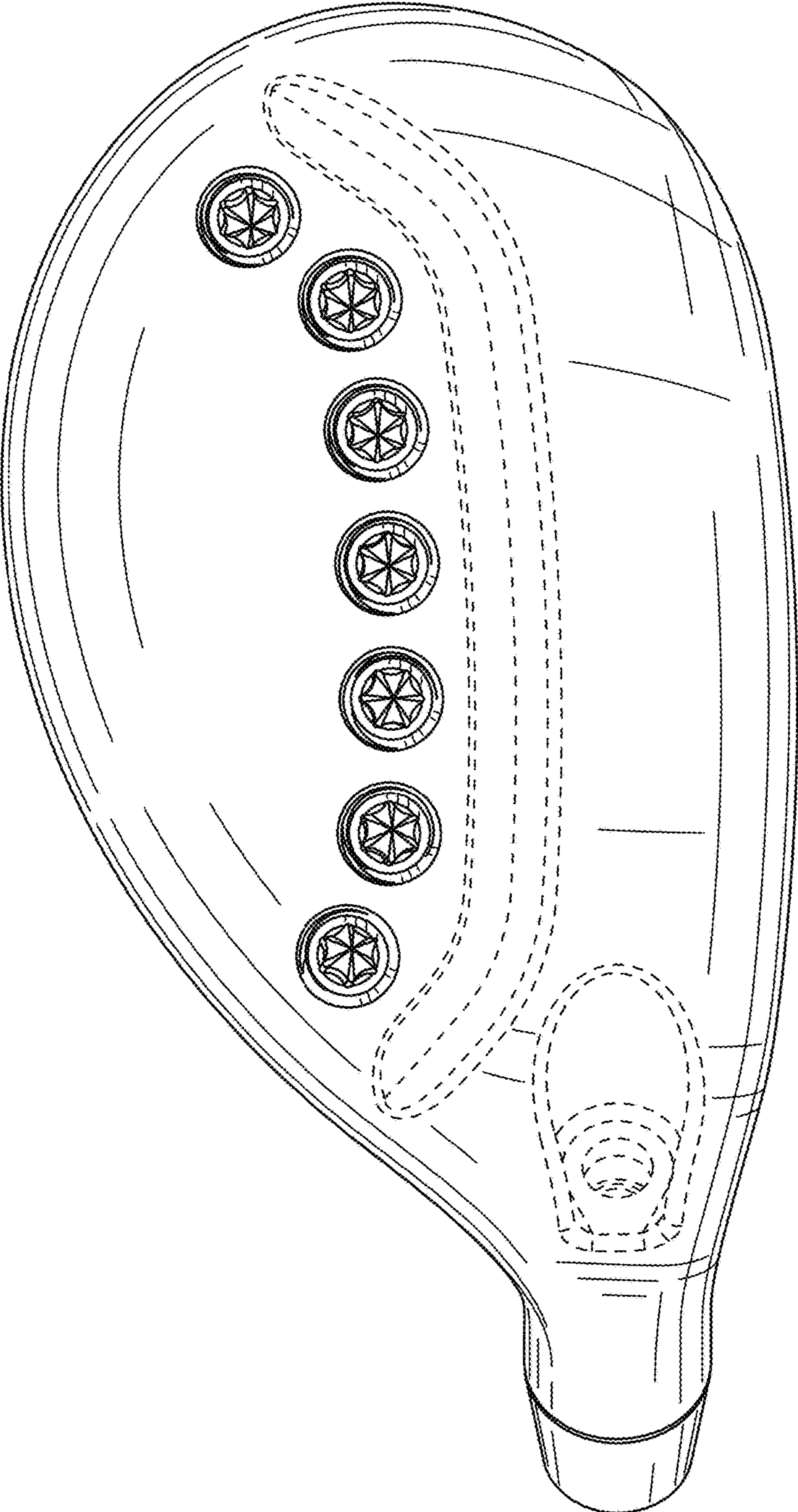

FIG. 30

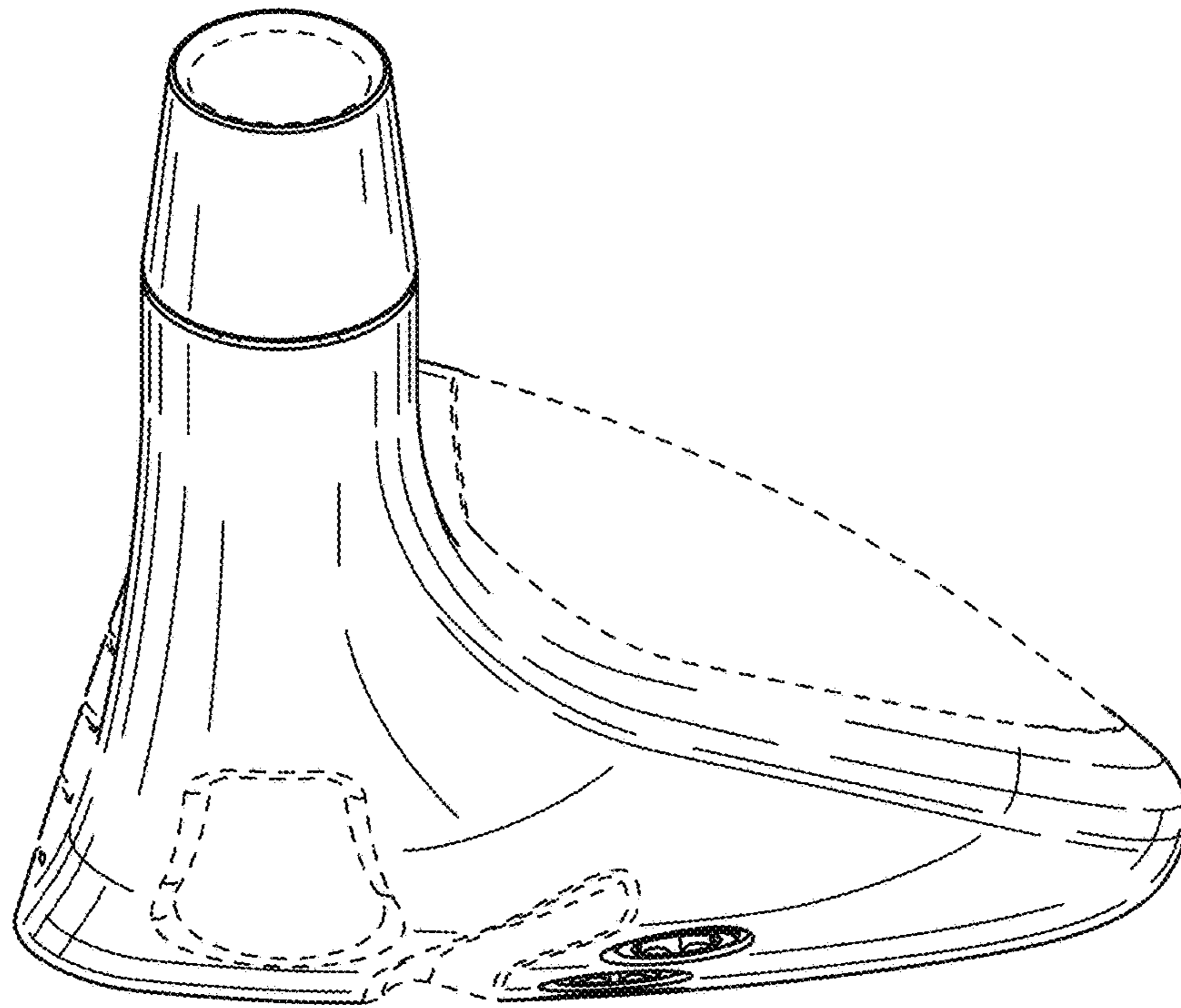

FIG. 31

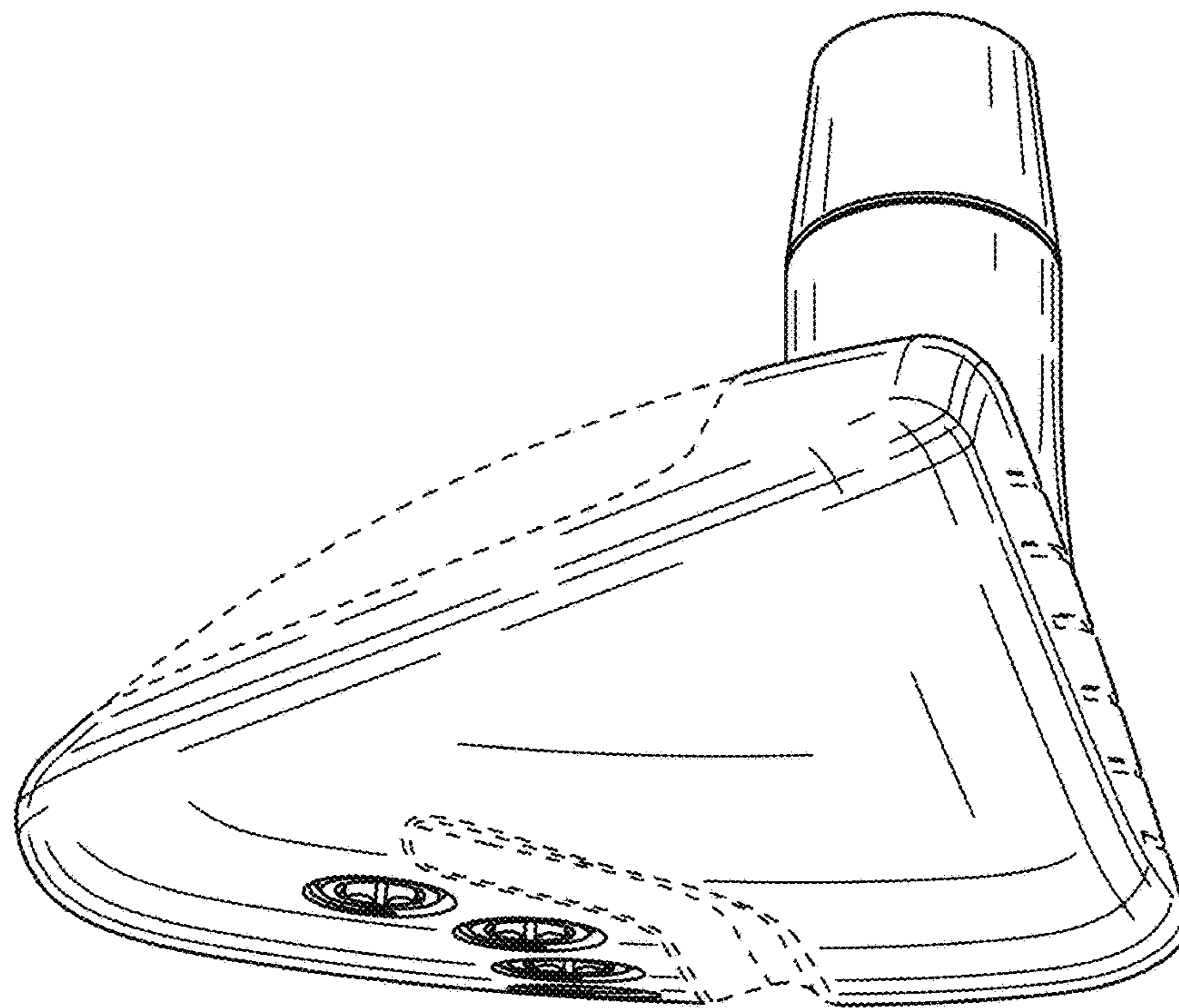

FIG. 32