



US00D776207S

(12) **United States Design Patent**
Norman et al.

(10) **Patent No.:** **US D776,207 S**
(45) **Date of Patent:** **** Jan. 10, 2017**

(54) **TOY SEAHORSE**

(71) Applicant: **Innovation First, Inc.**, Greenville, TX (US)

(72) Inventors: **David Anthony Norman**, Greenville, TX (US); **Robert H. Mimlitch, III**, Rowlett, TX (US); **Raul Olivera**, Greenville, TX (US); **Douglas Michael Galletti**, Allen, TX (US); **James Anthony Trzaskos**, Rockwall, TX (US); **Gregory James Lavender**, Rockwell, TX (US)

(73) Assignee: **Innovation First, Inc.**, Greenville, TX (US)

(**) Term: **14 Years**

(21) Appl. No.: **29/513,937**

(22) Filed: **Jan. 7, 2015**

(51) **LOC (10) Cl.** **21-01**

(52) **U.S. Cl.**
USPC **D21/599**; D21/658

(58) **Field of Classification Search**
USPC D6/598; D11/158; D21/576-585,
D21/597-601; 446/368-369, 376, 428,
446/487
CPC A63H 3/00; A63H 3/02; A63H 3/06;
A63H 3/14; A63H 3/28; A63H
3/36; A63H 33/00; A63H 33/003; A63H
3/004

See application file for complete search history.

(56) **References Cited**

U.S. PATENT DOCUMENTS

D136,553 S * 10/1943 Oya D11/158
D142,003 S * 8/1945 Champness D11/158

D192,170 S * 2/1962 Kovac D21/599
D228,481 S * 10/1973 Sahloff D11/134
D230,659 S * 3/1974 Bride D21/599
D245,805 S * 9/1977 Cone D21/599
D274,070 S * 5/1984 Ma D21/599
D276,834 S * 12/1984 Paczko D21/599
D298,735 S * 11/1988 Lakatos D11/158
D324,756 S * 3/1992 Meyers, Jr. D21/599
D519,401 S * 4/2006 Udko D11/82
D586,530 S * 2/2009 Madsen D1/111

* cited by examiner

Primary Examiner — Sandra Morris

(74) *Attorney, Agent, or Firm* — Adam K. Sacharoff;
Much Shelist

(57) **CLAIM**

The ornamental design for a toy seahorse, as shown and described.

DESCRIPTION

FIG. 1 is a front perspective view of an ornamental design for a toy seahorse;

FIG. 2 is a rear perspective view thereof;

FIG. 3 is an underside perspective view thereof;

FIG. 4 is a front elevation view thereof;

FIG. 5 is a rear elevation view thereof;

FIG. 6 is a left side view thereof;

FIG. 7 is a right side view thereof;

FIG. 8 is a top plan view thereof;

FIG. 9 is a bottom plan view thereof;

FIG. 10 is a front perspective view thereof;

FIG. 11 is a front elevation view thereof;

FIG. 12 is a top plan view thereof; and,

FIG. 13 is a bottom plan view thereof.

The broken lines in the figures are included to show unclaimed subject matter only and form no part of the claimed design.

1 Claim, 11 Drawing Sheets

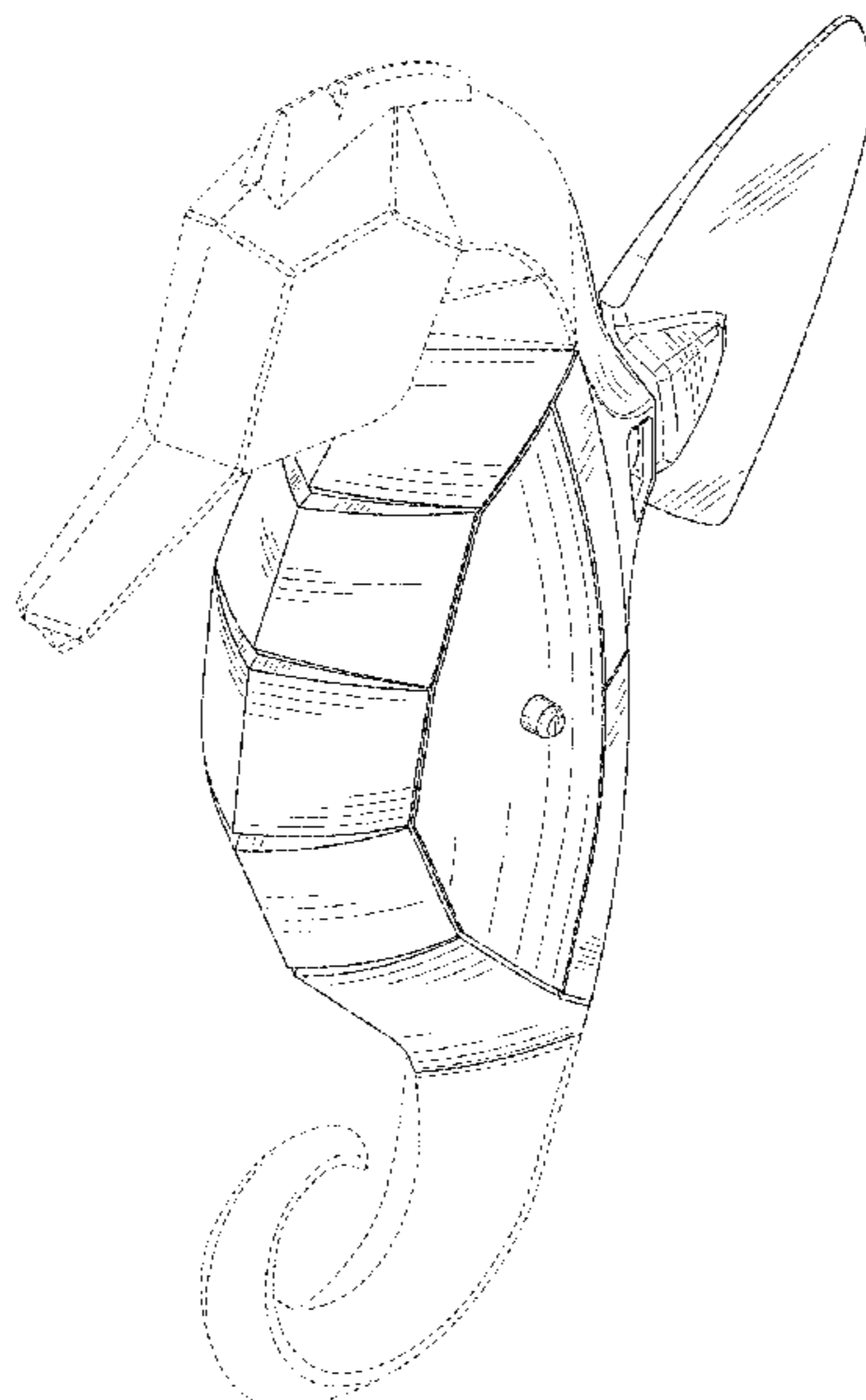

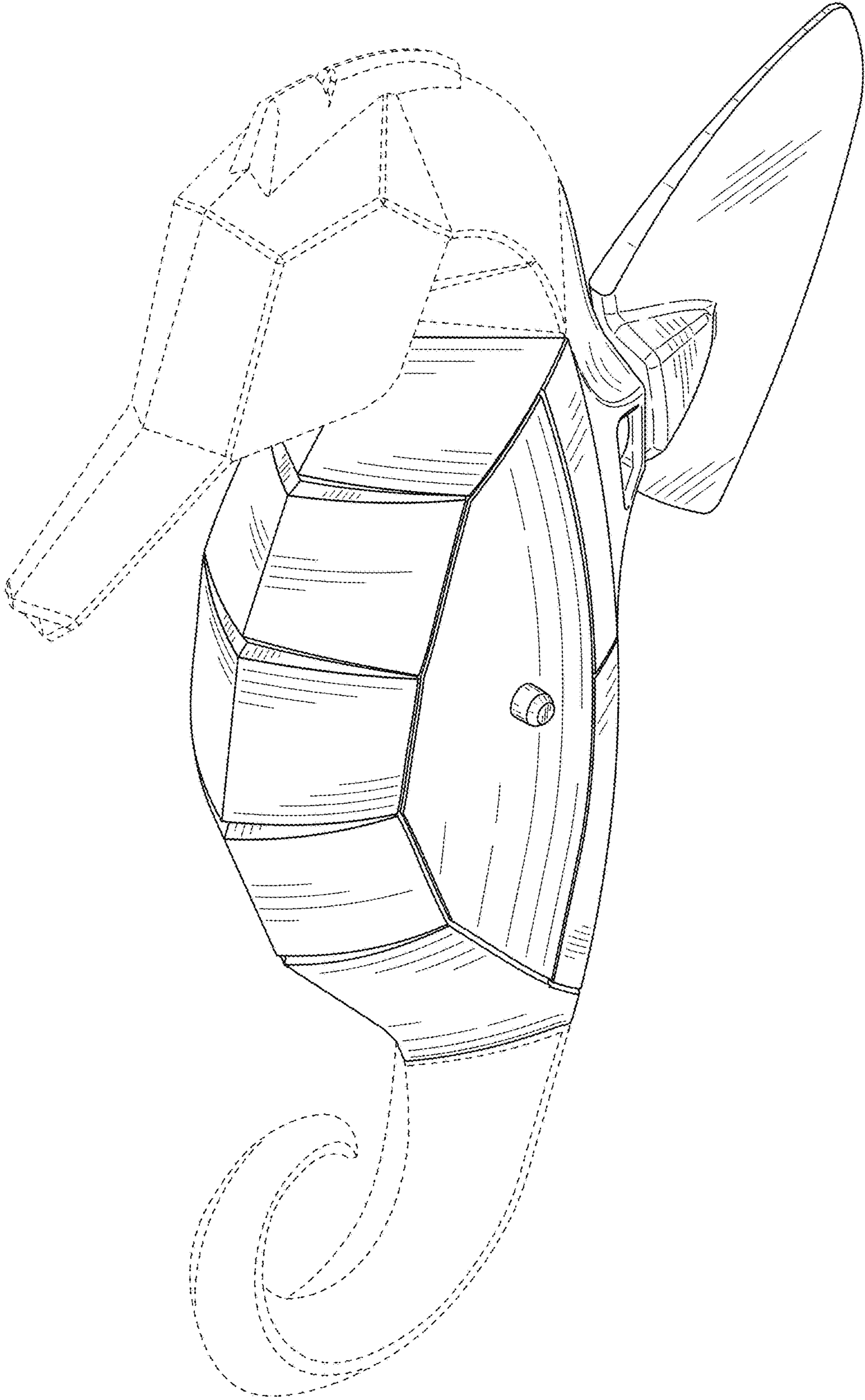

FIG. 1

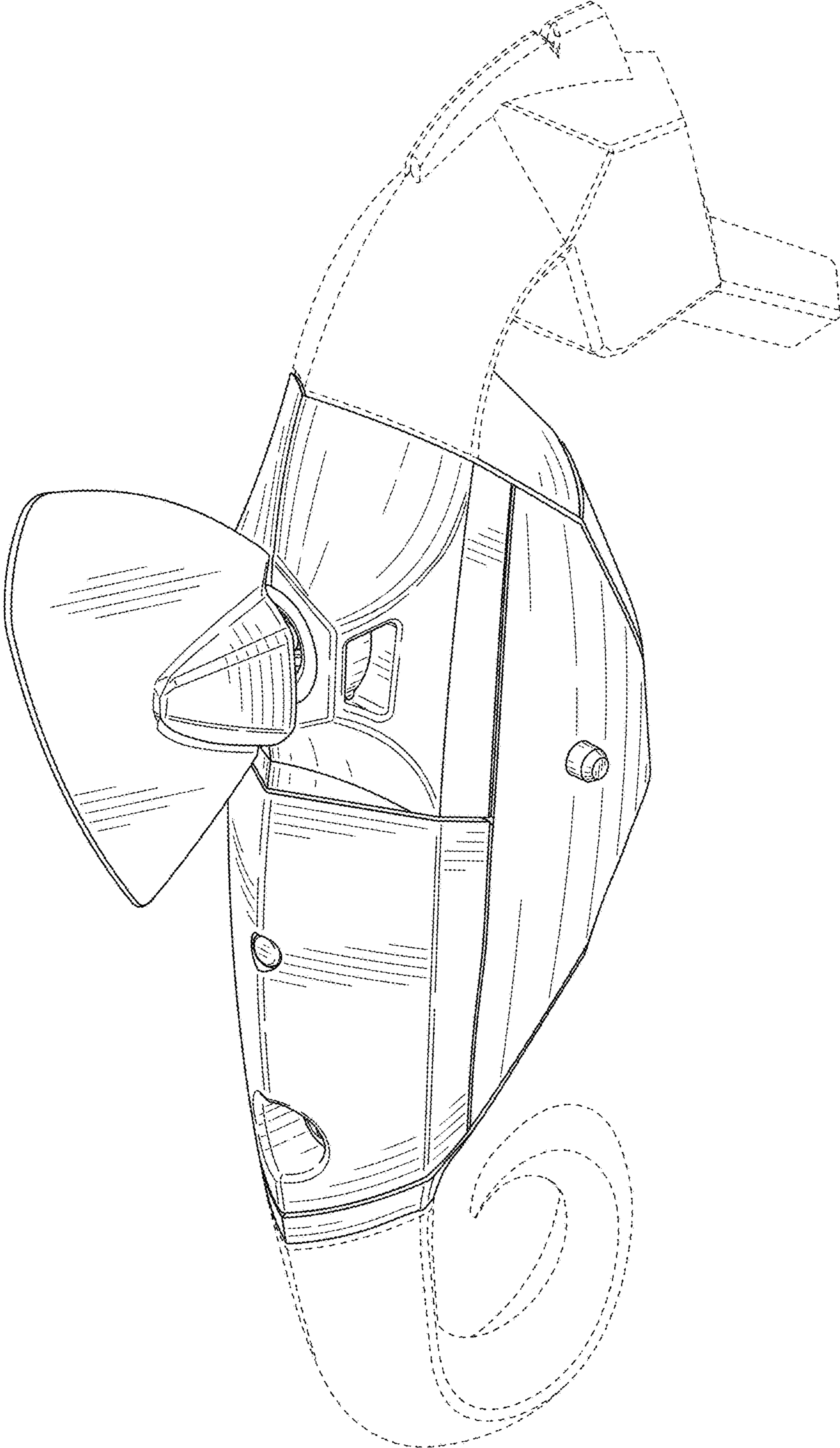

FIG. 2

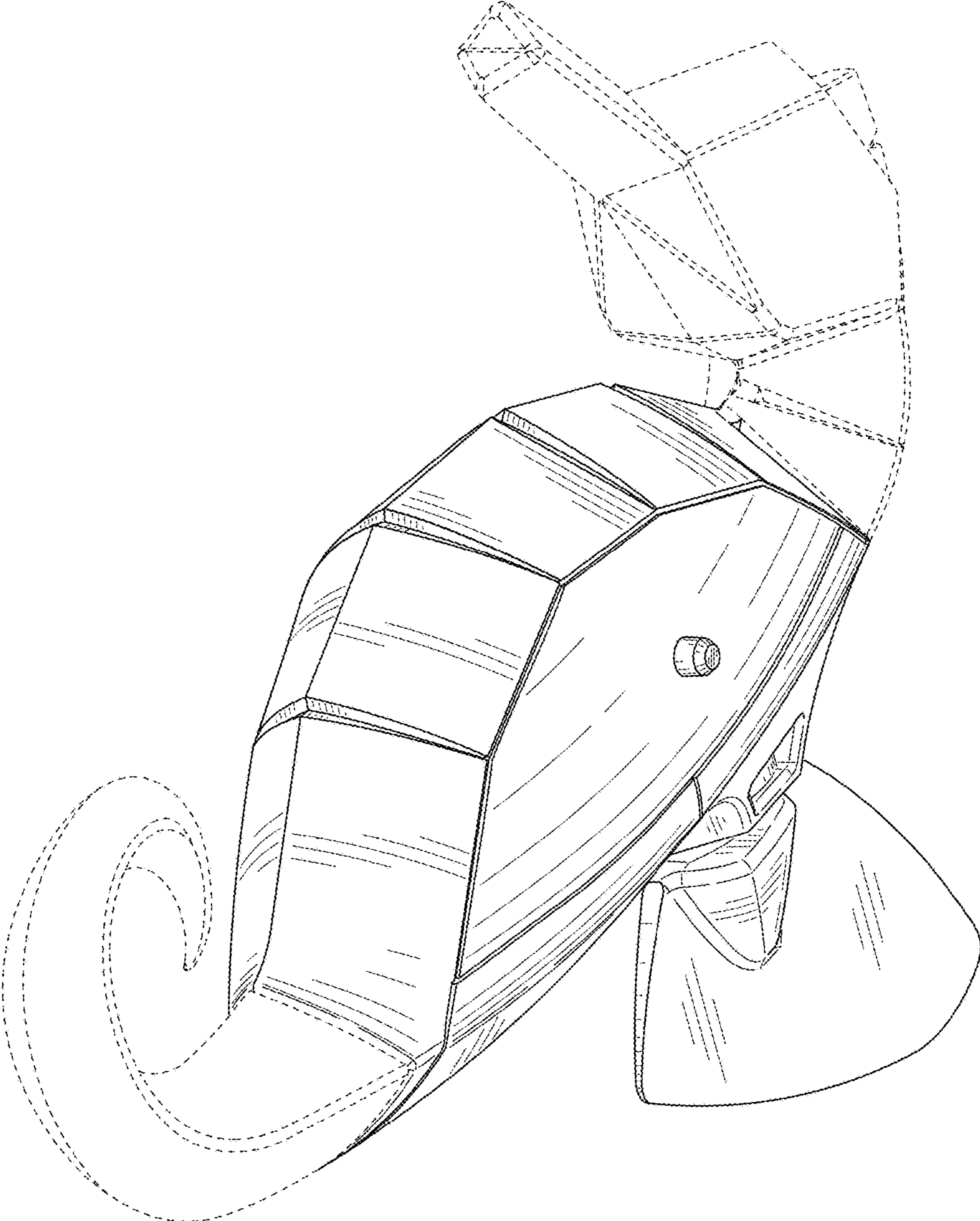

FIG. 3

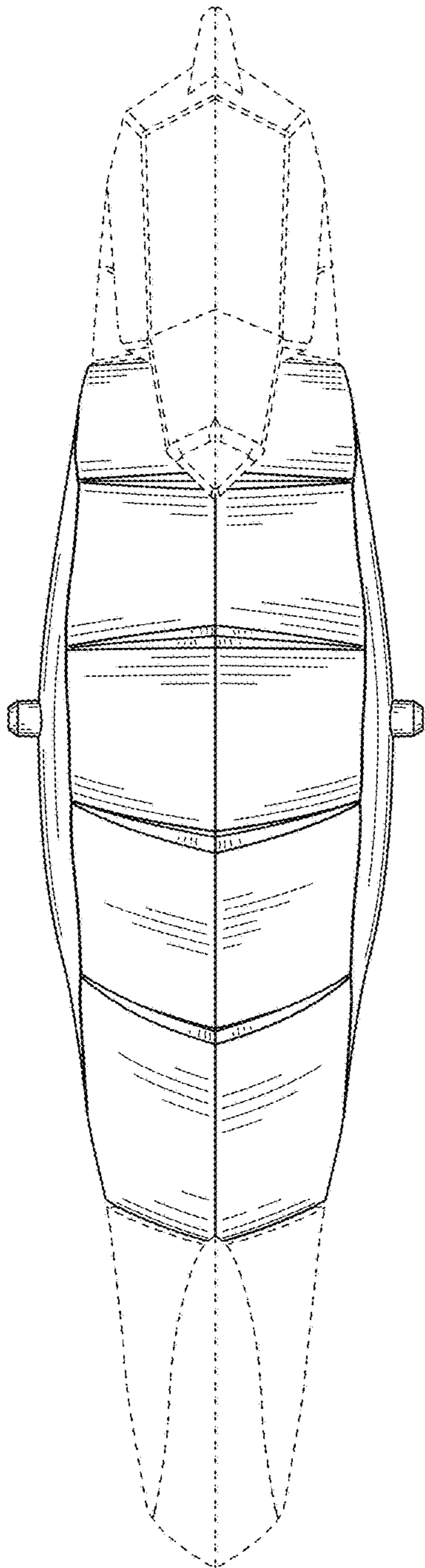

FIG. 4

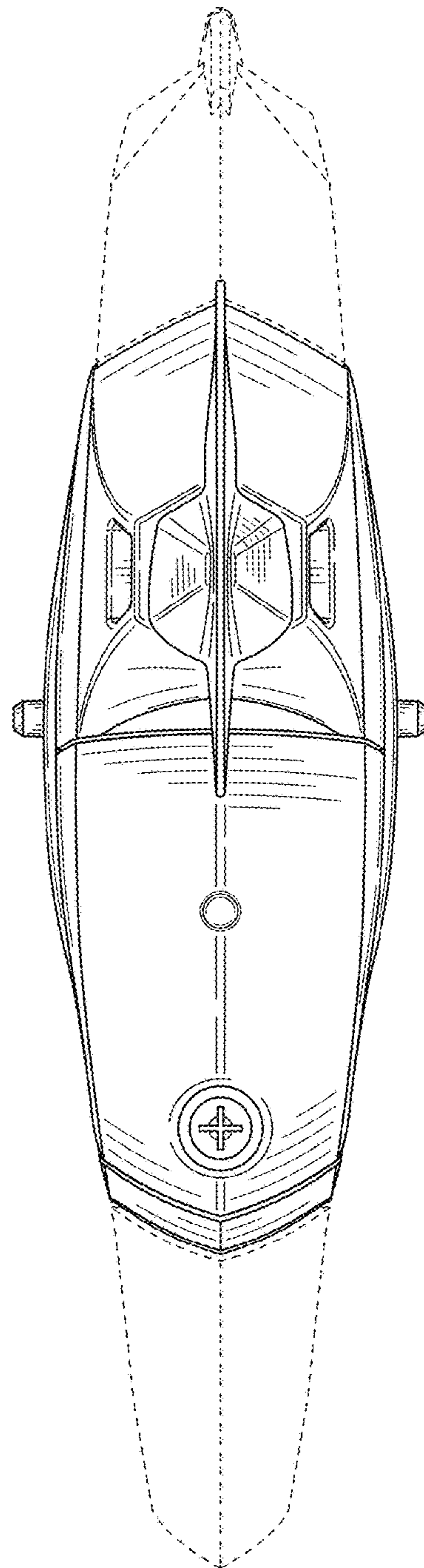

FIG. 5

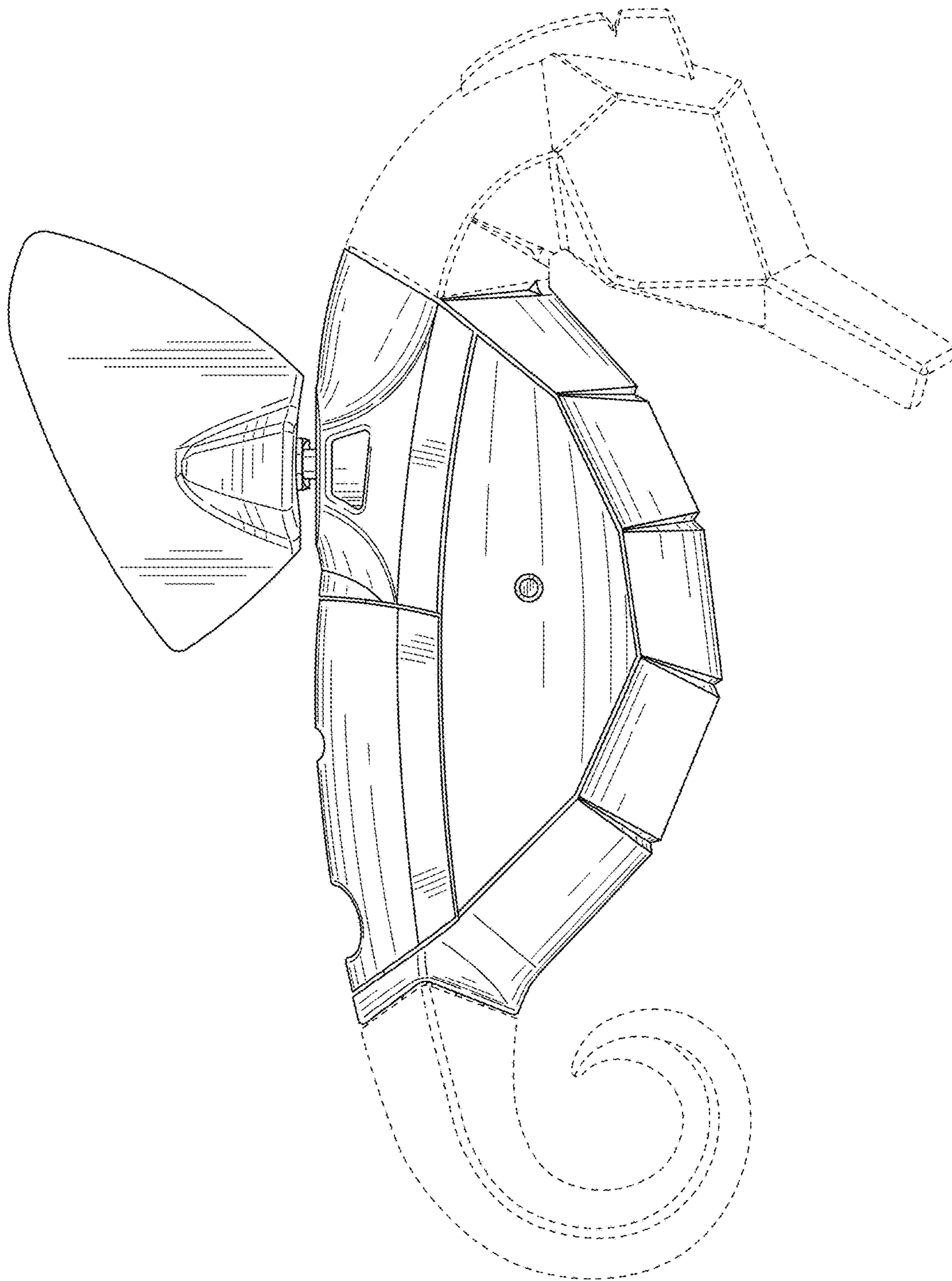

FIG. 6

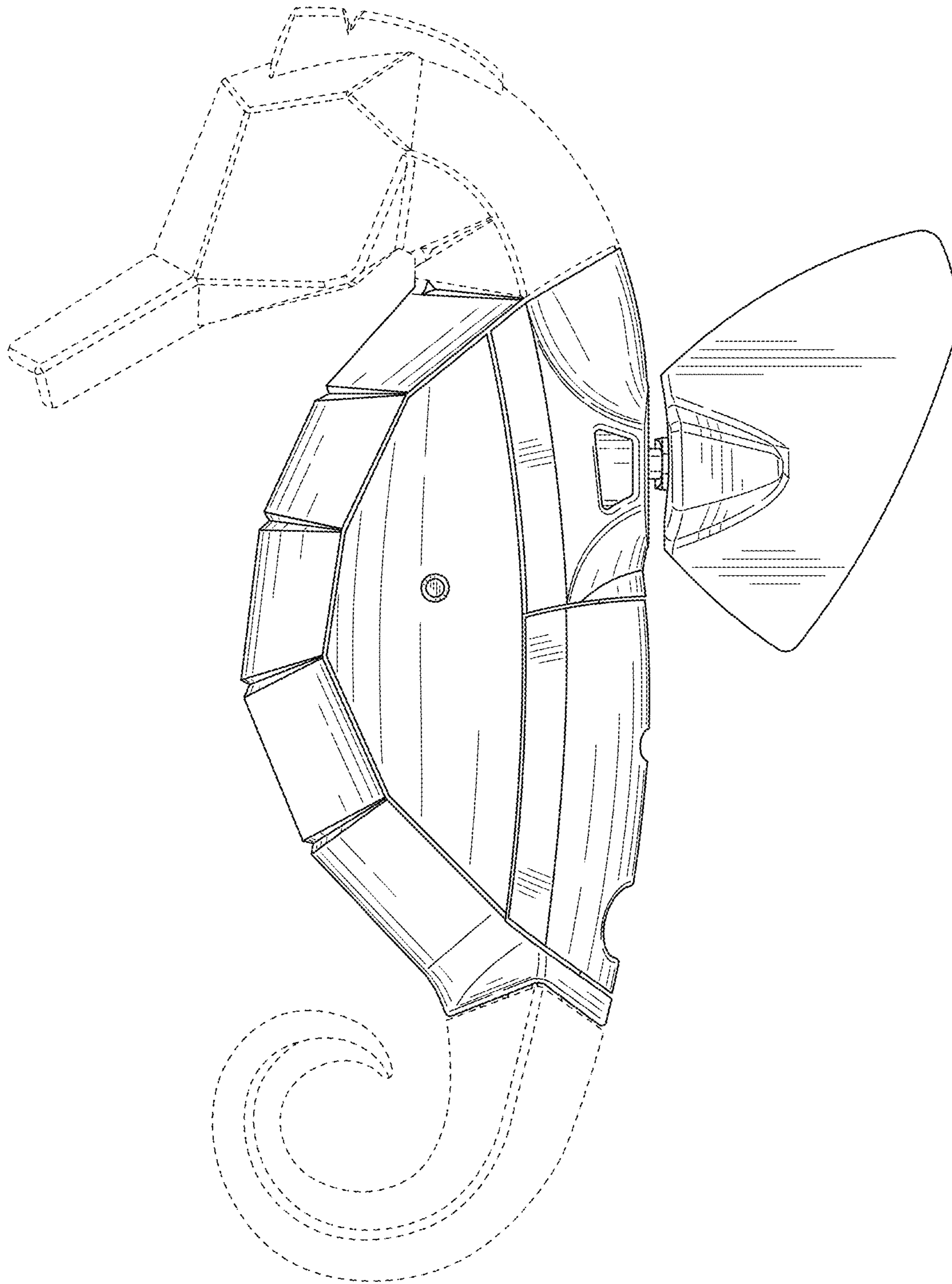

FIG. 7

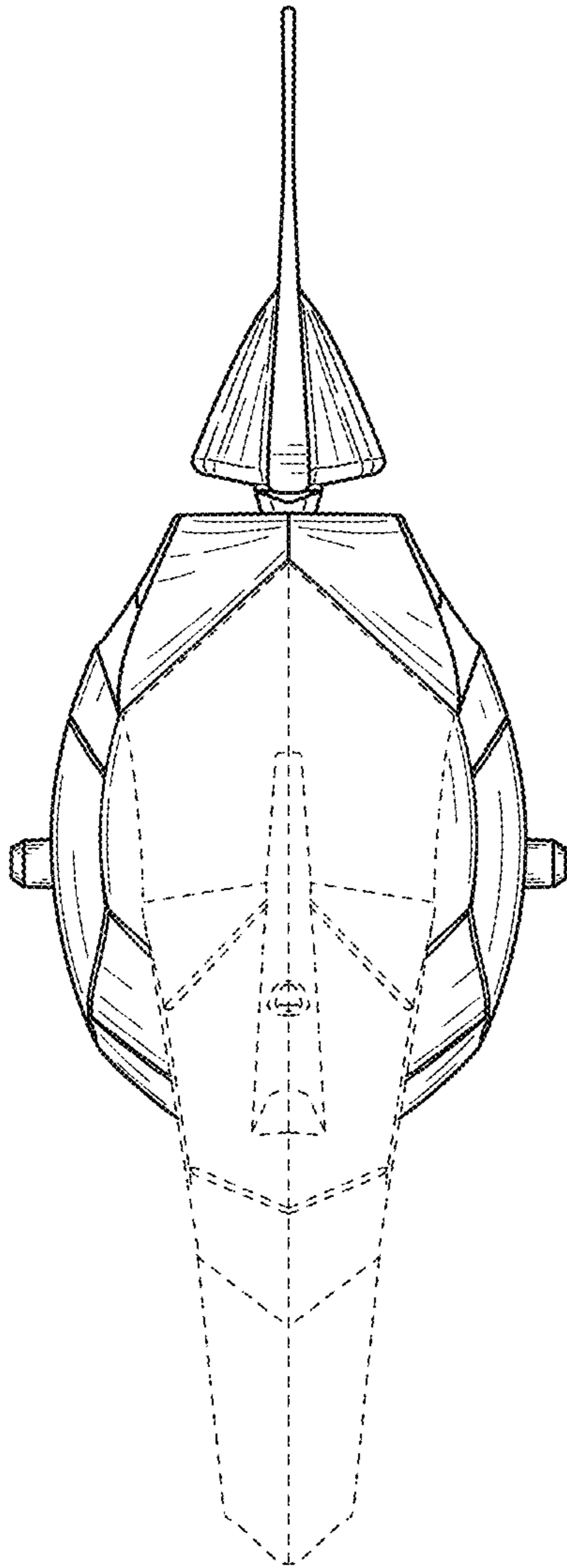

FIG. 8

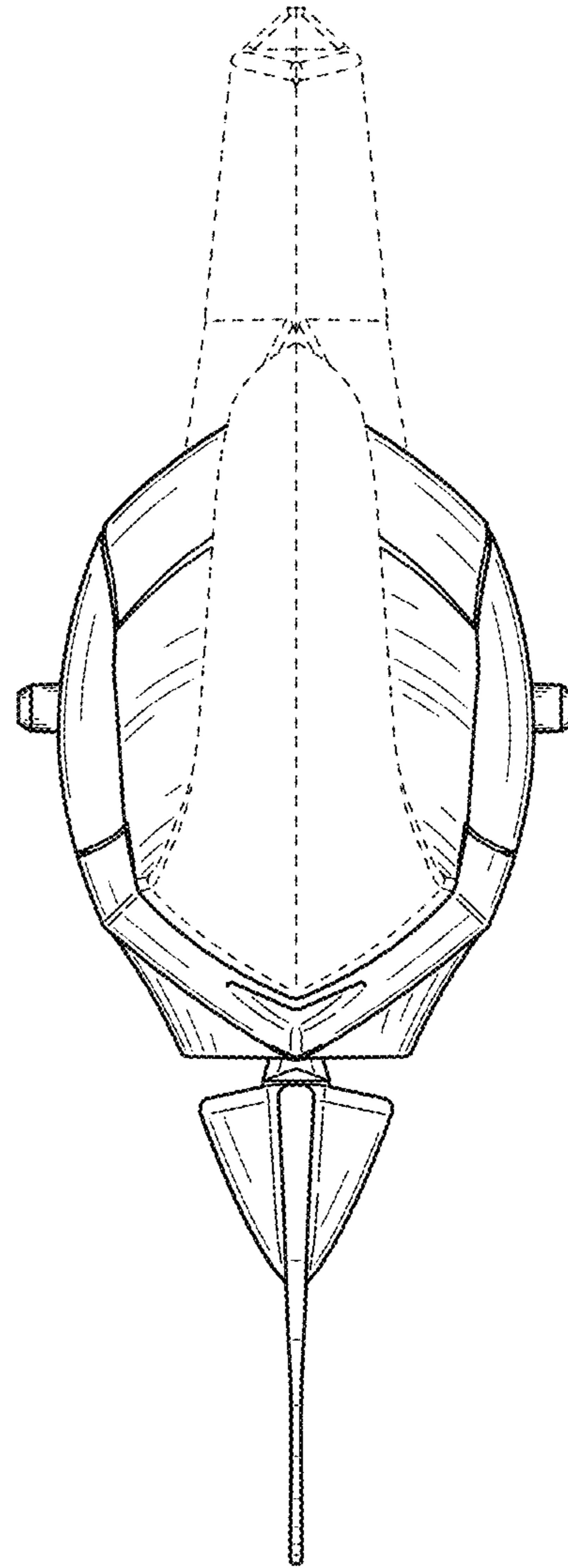

FIG. 9

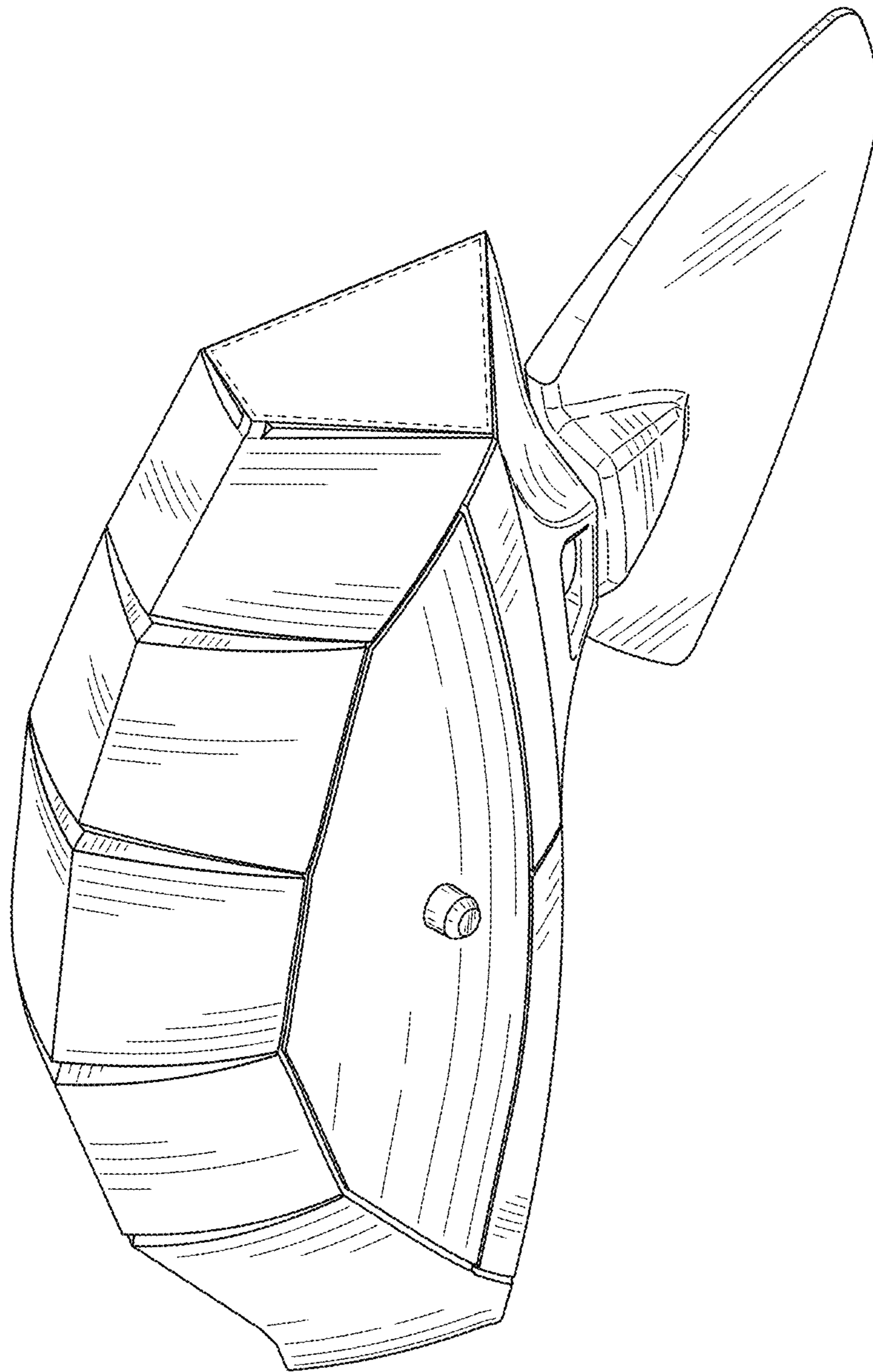

FIG. 10

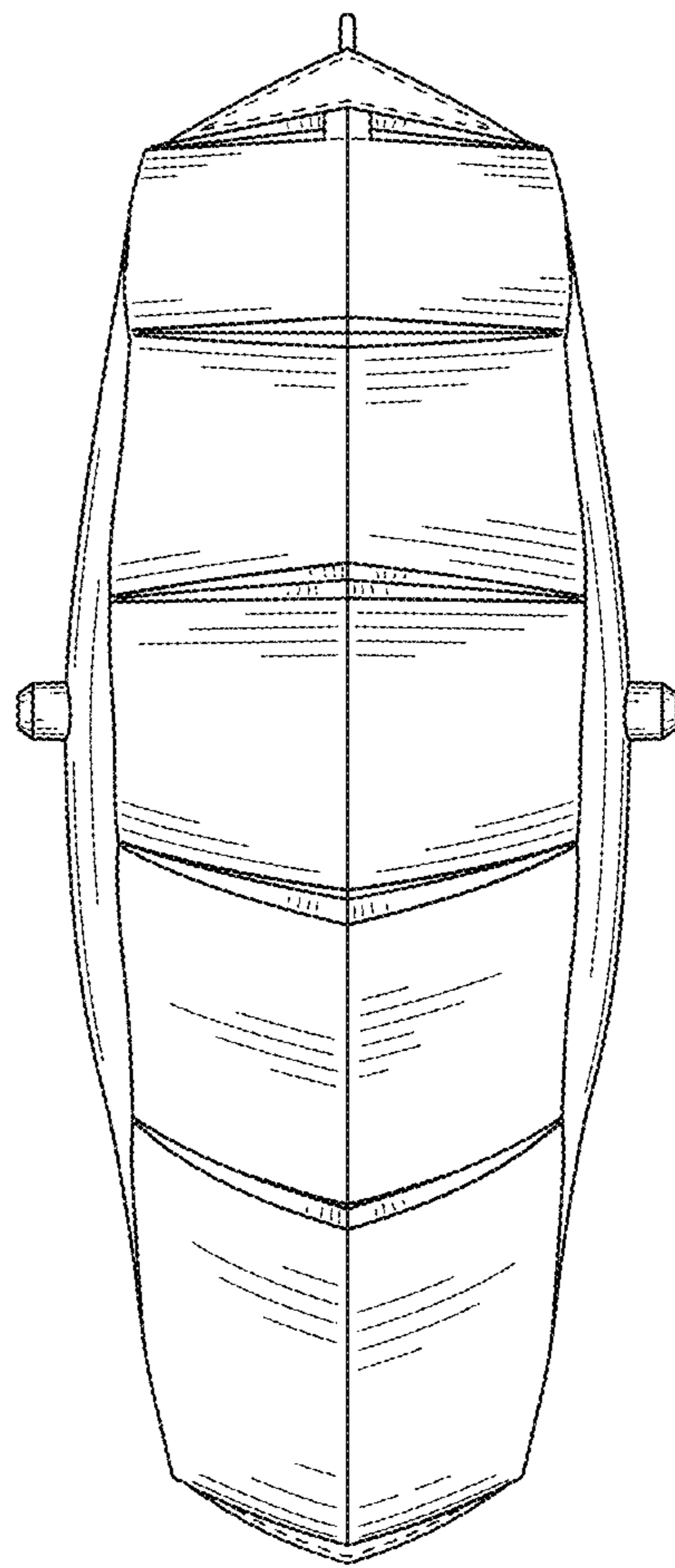

FIG. 11

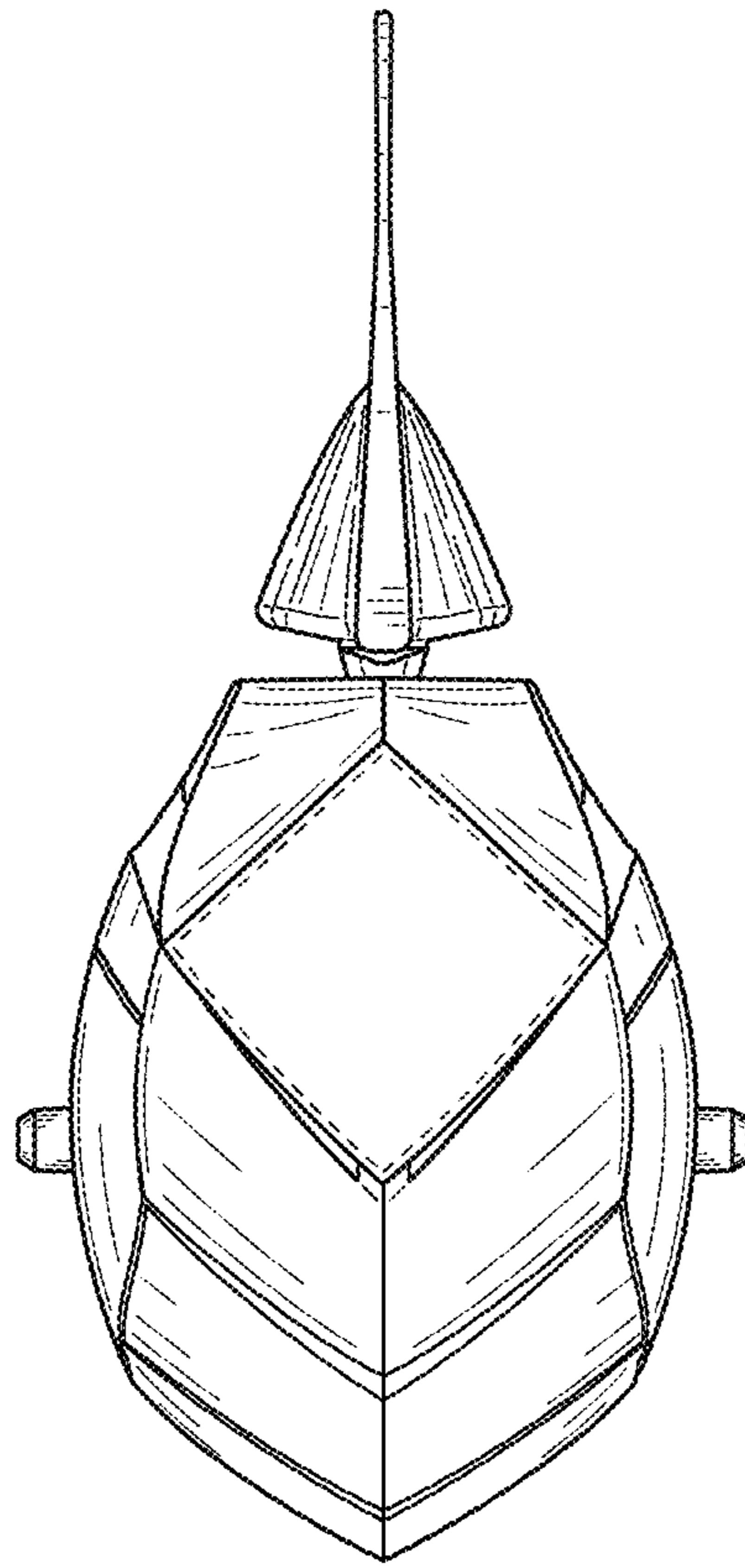

FIG. 12

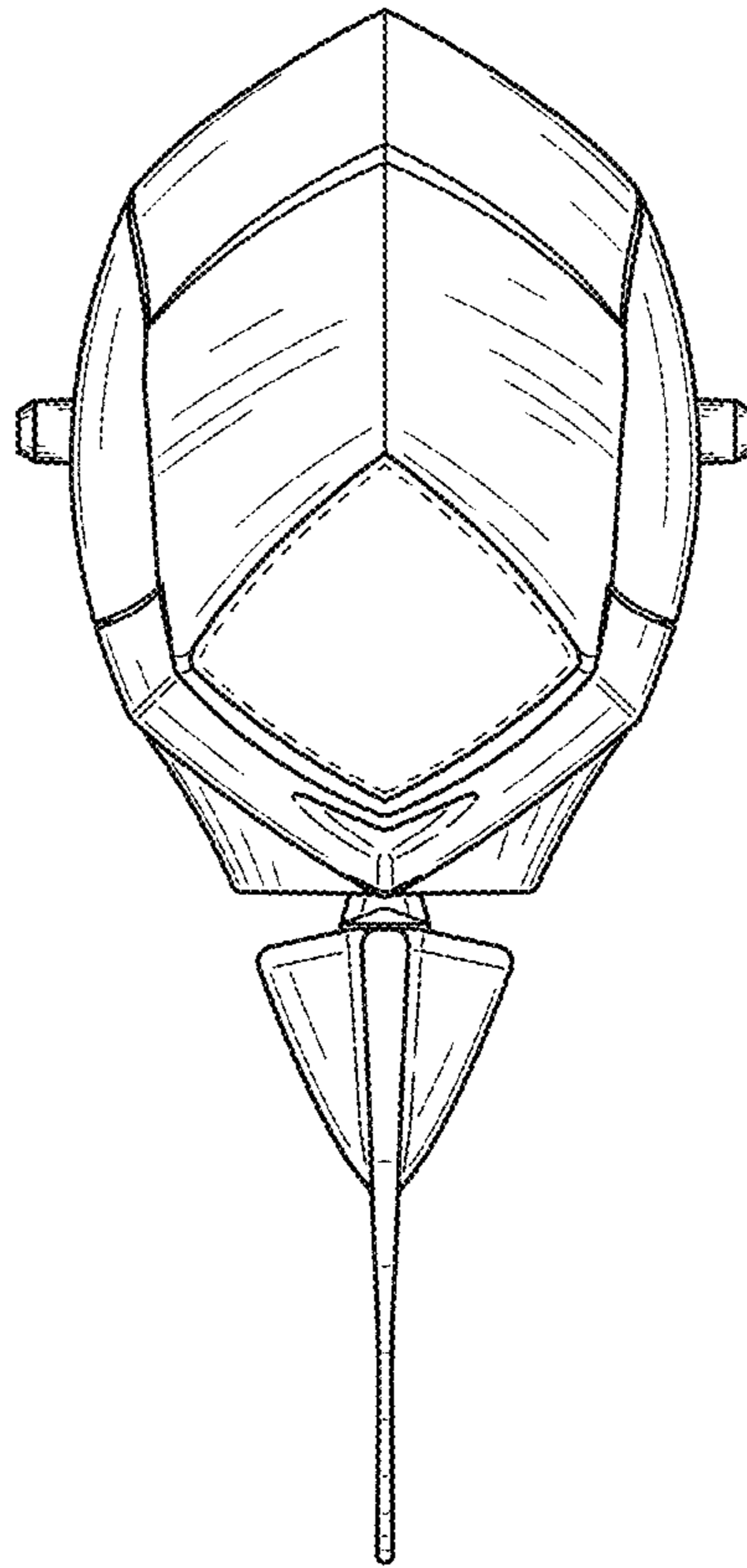

FIG. 13