



US00D775895S

(12) **United States Design Patent**
Mayberry

(10) **Patent No.:** **US D775,895 S**

(45) **Date of Patent:** **** Jan. 10, 2017**

(54) **FOOTBALL HELMET-SHAPED CONTAINER**

(71) Applicant: **Adam Mayberry**, Brentwood, TN (US)

(72) Inventor: **Adam Mayberry**, Brentwood, TN (US)

(**) Term: **15 Years**

(21) Appl. No.: **29/545,602**

(22) Filed: **Nov. 13, 2015**

(51) **LOC (10) Cl.** **07-01**

(52) **U.S. Cl.**
USPC **D7/517; D7/515; D7/567; D7/628;**
D9/668

(58) **Field of Classification Search**

USPC D9/600, 614–628, 631–632, 668,
D9/500–505, 516, 544–545, D9/549–558,
D9/572–575; 206/457, 494, 459.5, 527,
206/540, 890; 229/116.1; 446/77;
215/381–384, 400; D7/514–518, 539,
544, 567, 571, 579, 604, D7/613, 619.2,
D7/623, 628–630, 391–392.1; D21/659;
D11/160

CPC B65D 67/00; B65D 81/36; B65D 81/60;
B65D 81/368; B65D 2203/00; B65D
2203/02; B65D 51/245; B65D
81/365; B65D 81/366; A63H 33/16

See application file for complete search history.

(56) **References Cited**

U.S. PATENT DOCUMENTS

D243,578 S *	3/1977	Danat	D7/515
D250,444 S *	12/1978	Danat	D7/515
D251,225 S *	3/1979	Danat	D7/517
D251,226 S *	3/1979	Danat	D7/517
D314,492 S *	2/1991	Weller	D7/623
D337,242 S *	7/1993	Steinfels, III	D7/514
D344,659 S *	3/1994	Hsu	D7/514
D349,216 S *	8/1994	Steinfels, III	D7/623
D369,114 S *	4/1996	Davidov	D7/514
D369,529 S *	5/1996	Blankenburg	D7/515
D370,836 S *	6/1996	Van Blankenburg	D7/515
6,029,855 A *	2/2000	Adams	B65D 81/366 222/525

(Continued)

OTHER PUBLICATIONS

WinCraft item #2601711, offered for sale Oct. 4, 2016 9:05 am CST on Amazon at web address—<https://www.amazon.com/WinCraft-NFL-Snack-Helmet/dp/B005WWRXK6>.

Primary Examiner — Sandra Morris

(74) *Attorney, Agent, or Firm* — Bradley Arant Boulton Cummings LLP; Timothy L. Capria

(57) **CLAIM**

What is claimed is the ornamental design for a football helmet-shaped container, as shown and described.

DESCRIPTION

FIG. 1 is a top perspective view of the football helmet-shaped container. The circular broken line is shown to define a boundary around an aperture that defines an interior bowl of the football helmet-shaped container. The area within the circular broken line boundary is not part of the claimed design.

FIG. 2 is a bottom perspective view of the football helmet-shaped container of FIG. 1. The areas within the broken lines are not part of the claimed design.

FIG. 3 is a front elevation view of the football helmet-shaped container of FIG. 1. The area within the broken lines is not part of the claimed design.

FIG. 4 is rear elevation view of the football helmet-shaped container of FIG. 1.

FIG. 5 is a left side view of the football helmet-shaped container of FIG. 1. The right side view (not shown) is a mirror image of FIG. 5.

FIG. 6 is a top plan view of the football helmet-shaped container of FIG. 1. The area within the circular broken lines is not part of the claimed design; and,

FIG. 7 is a bottom plan view of the football helmet-shaped container of FIG. 1. The area within the broken lines is not part of the claimed design.

1 Claim, 3 Drawing Sheets

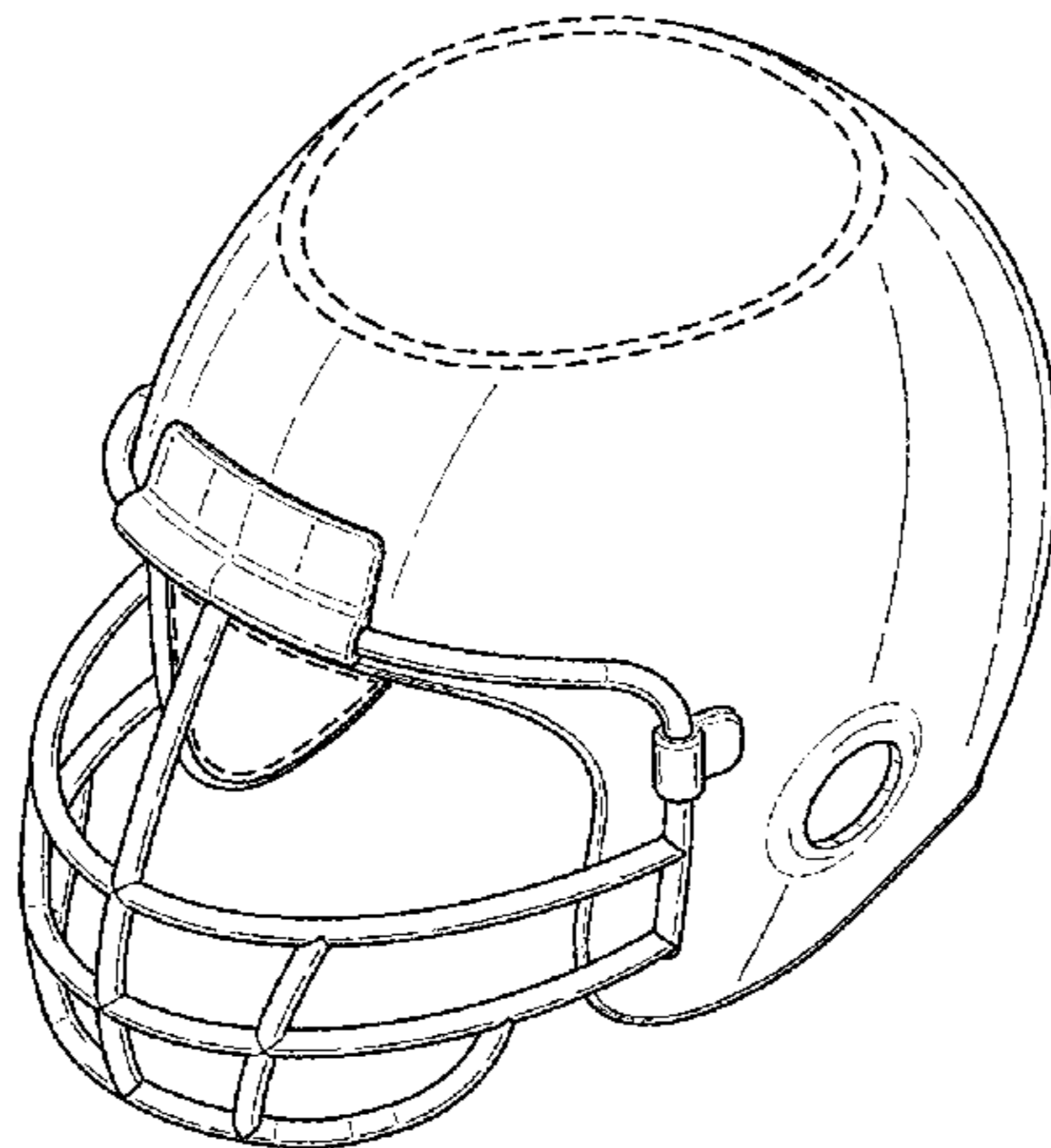

(56)

References Cited

U.S. PATENT DOCUMENTS

D471,060	S	*	3/2003	Salsman	D9/451
D507,181	S	*	7/2005	Malik	D9/451
D596,670	S	*	7/2009	Baker	D19/82
D682,941	S	*	5/2013	Nash	D19/69
D698,599	S	*	2/2014	Malik	D7/392.1
8,701,907	B1	*	4/2014	Mallicoat	B65D 51/245 D9/451

* cited by examiner

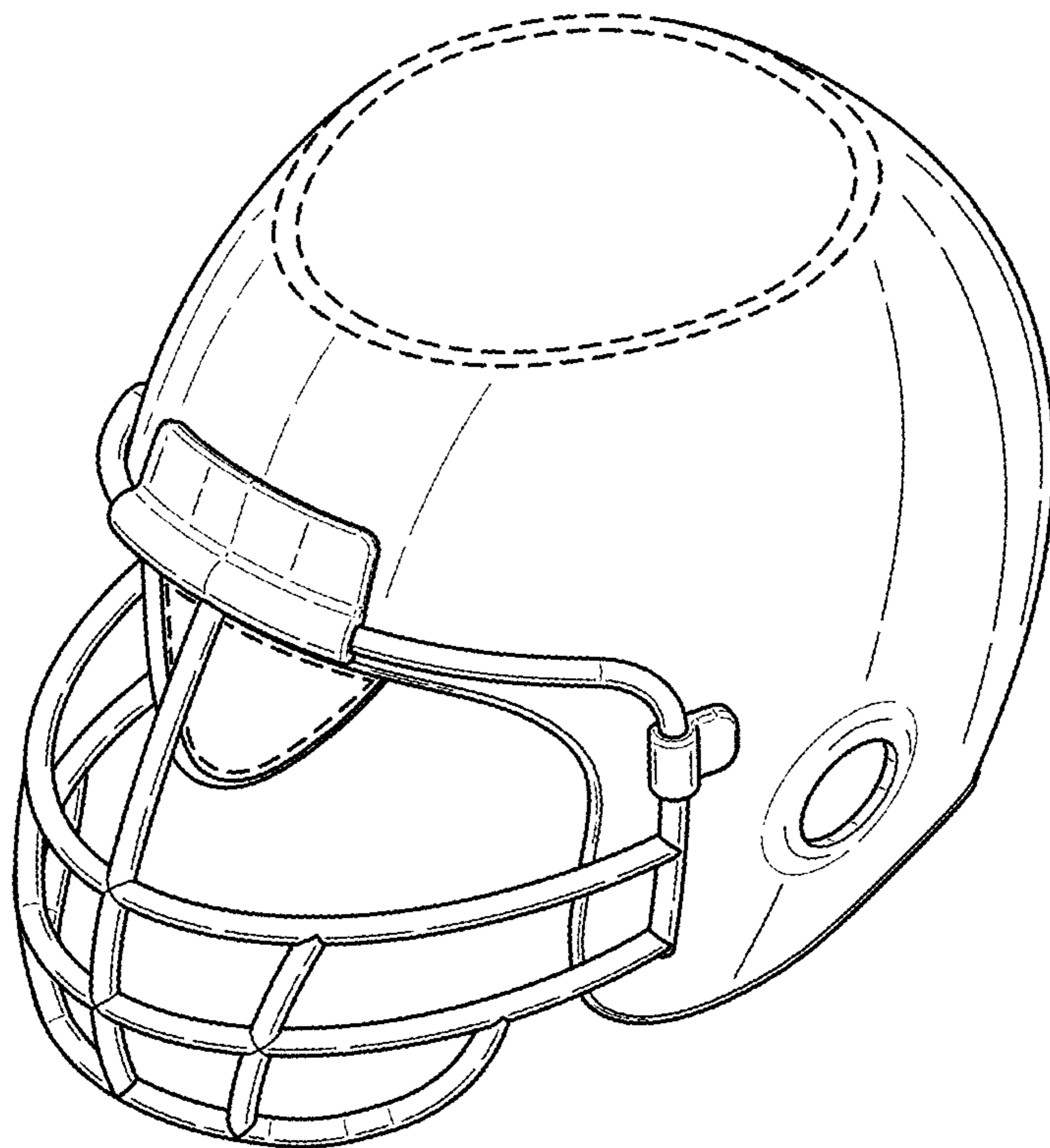

FIG. 1

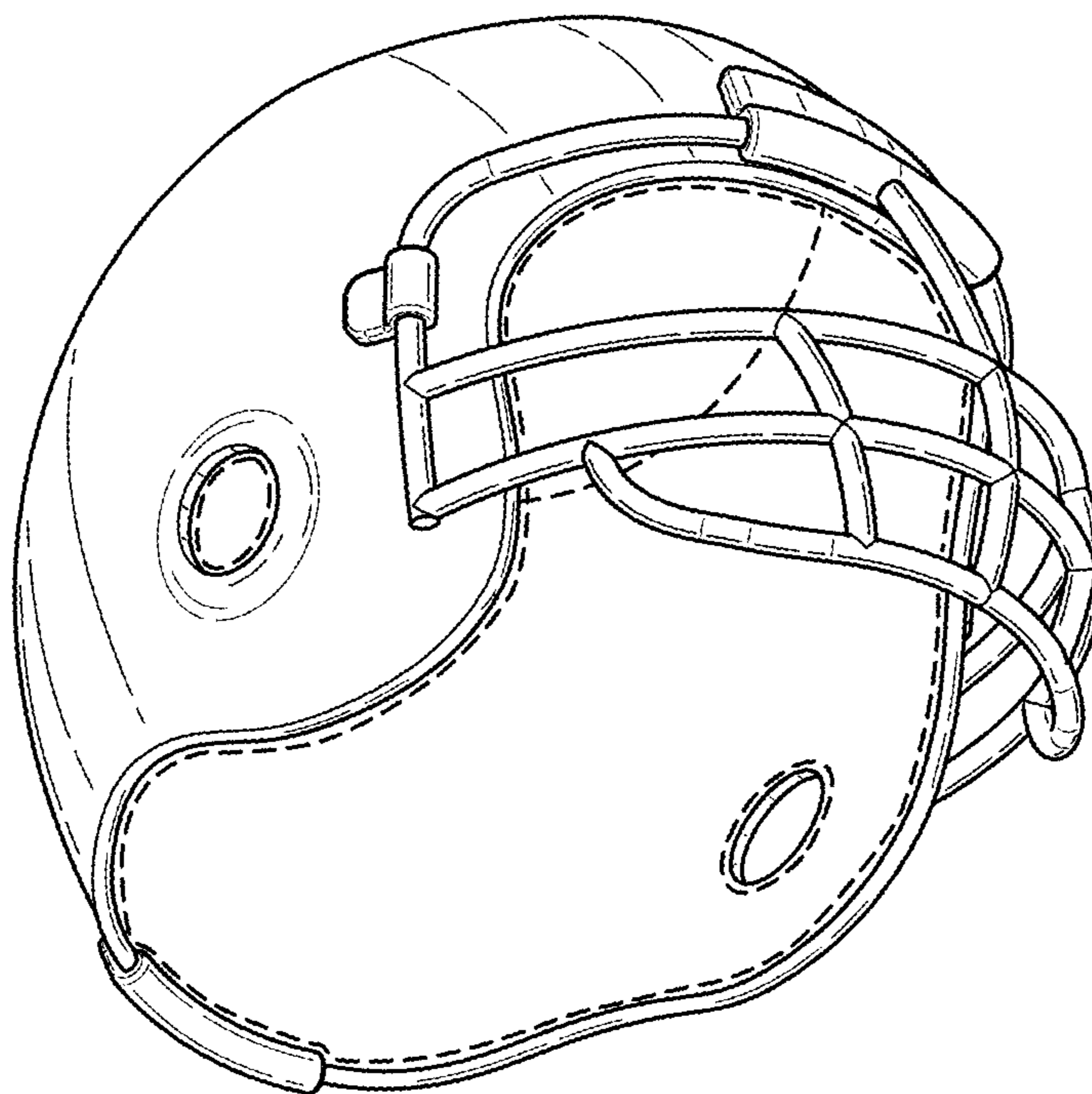

FIG. 2

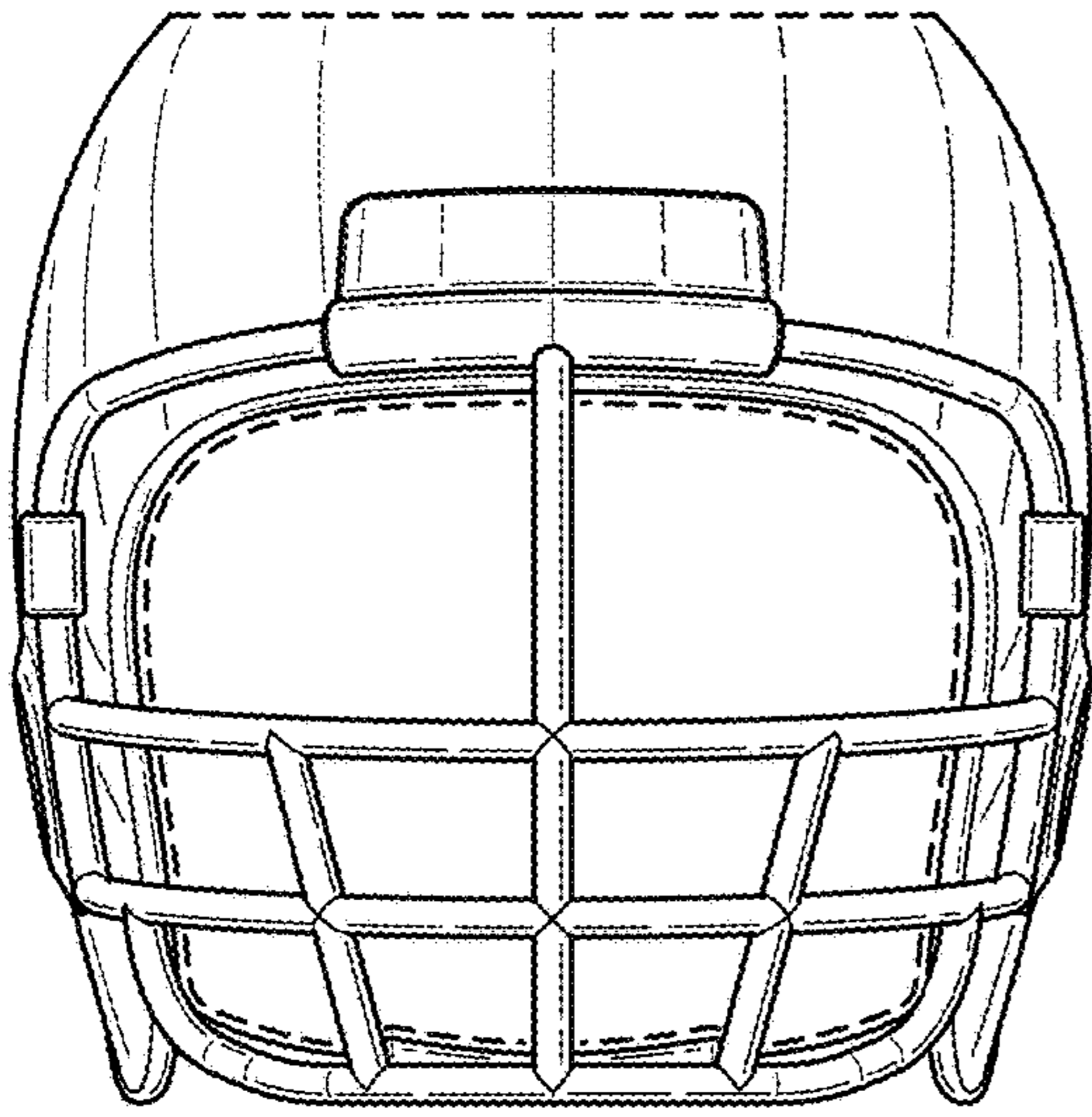

FIG. 3

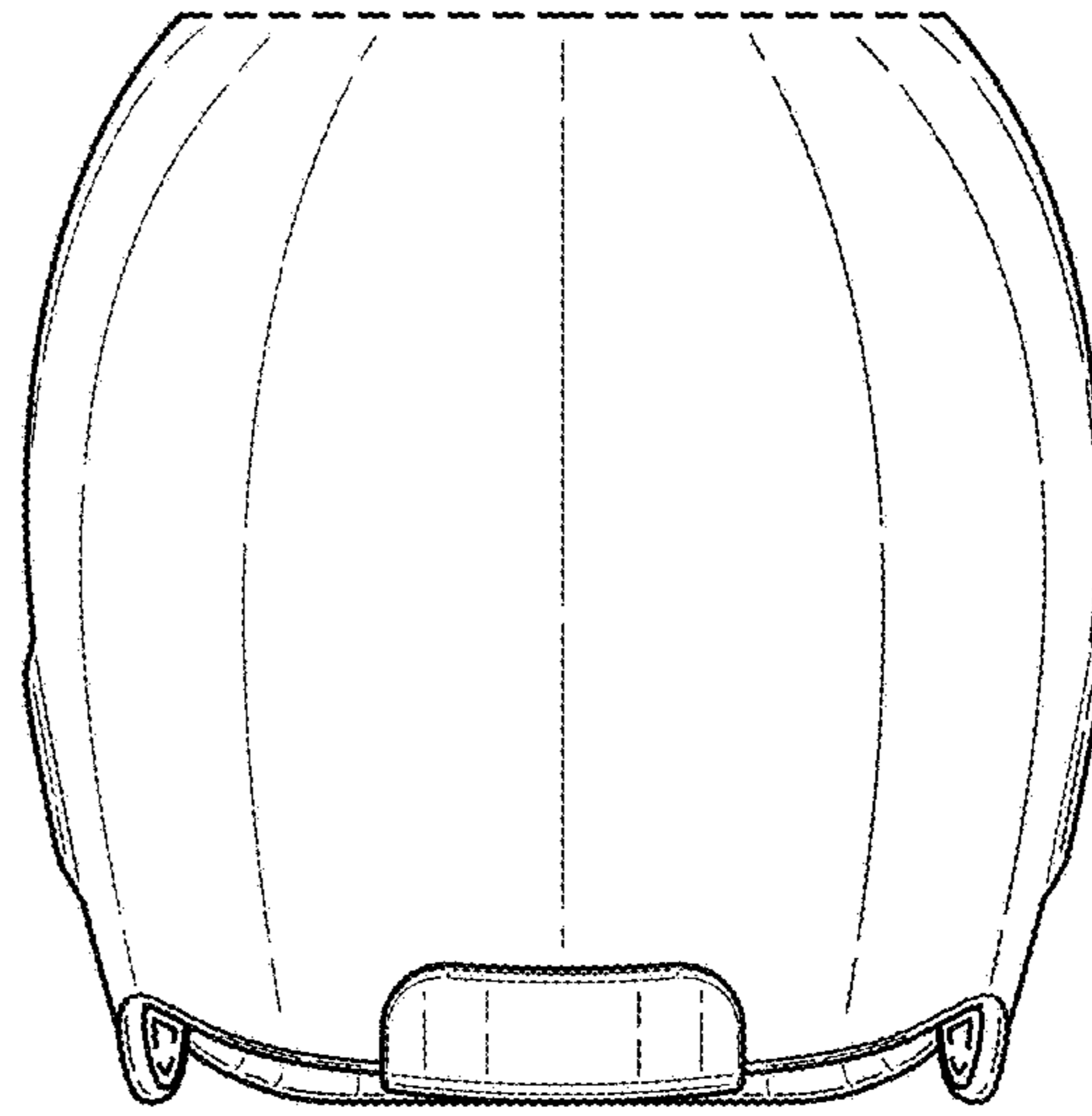

FIG. 4

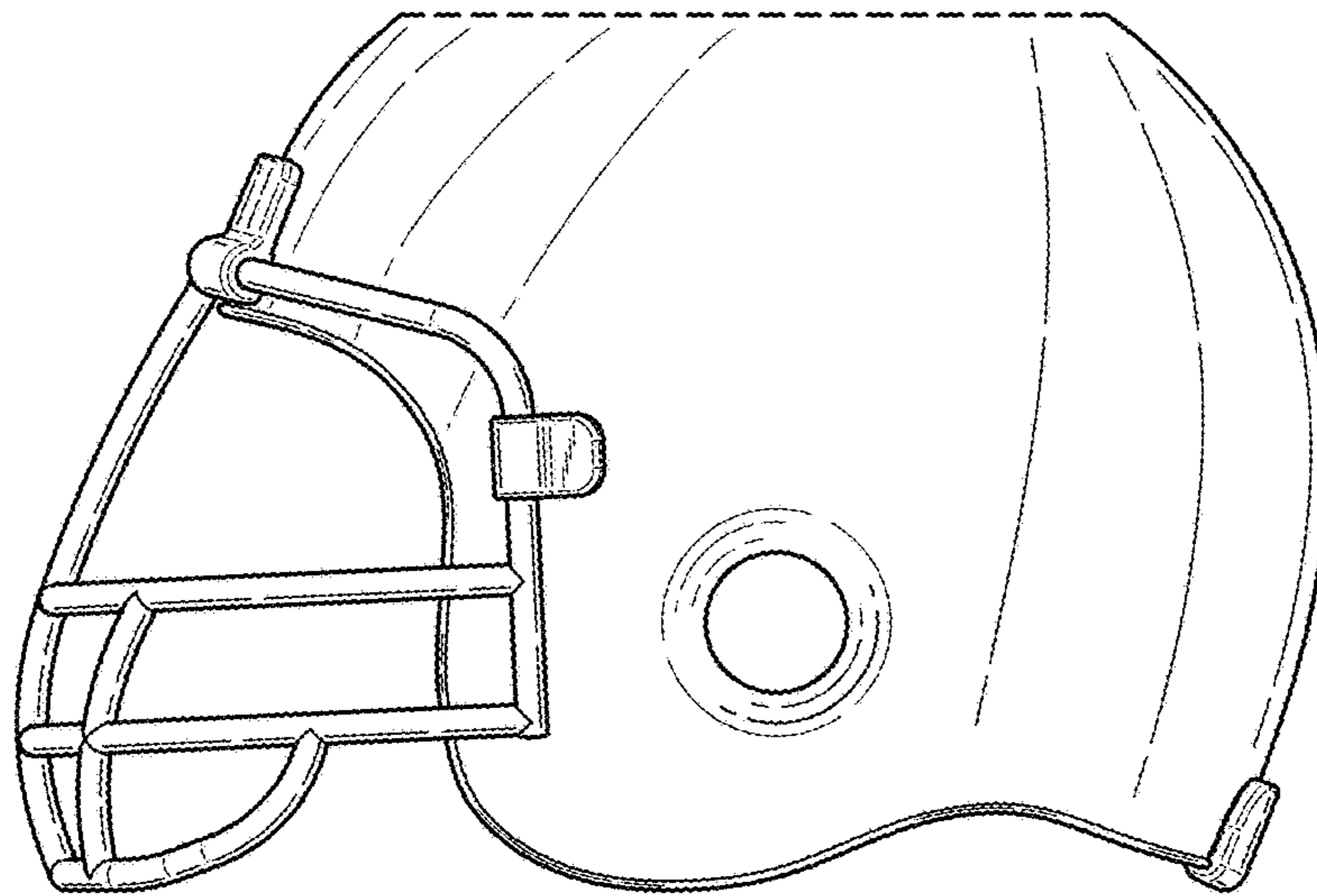

FIG. 5

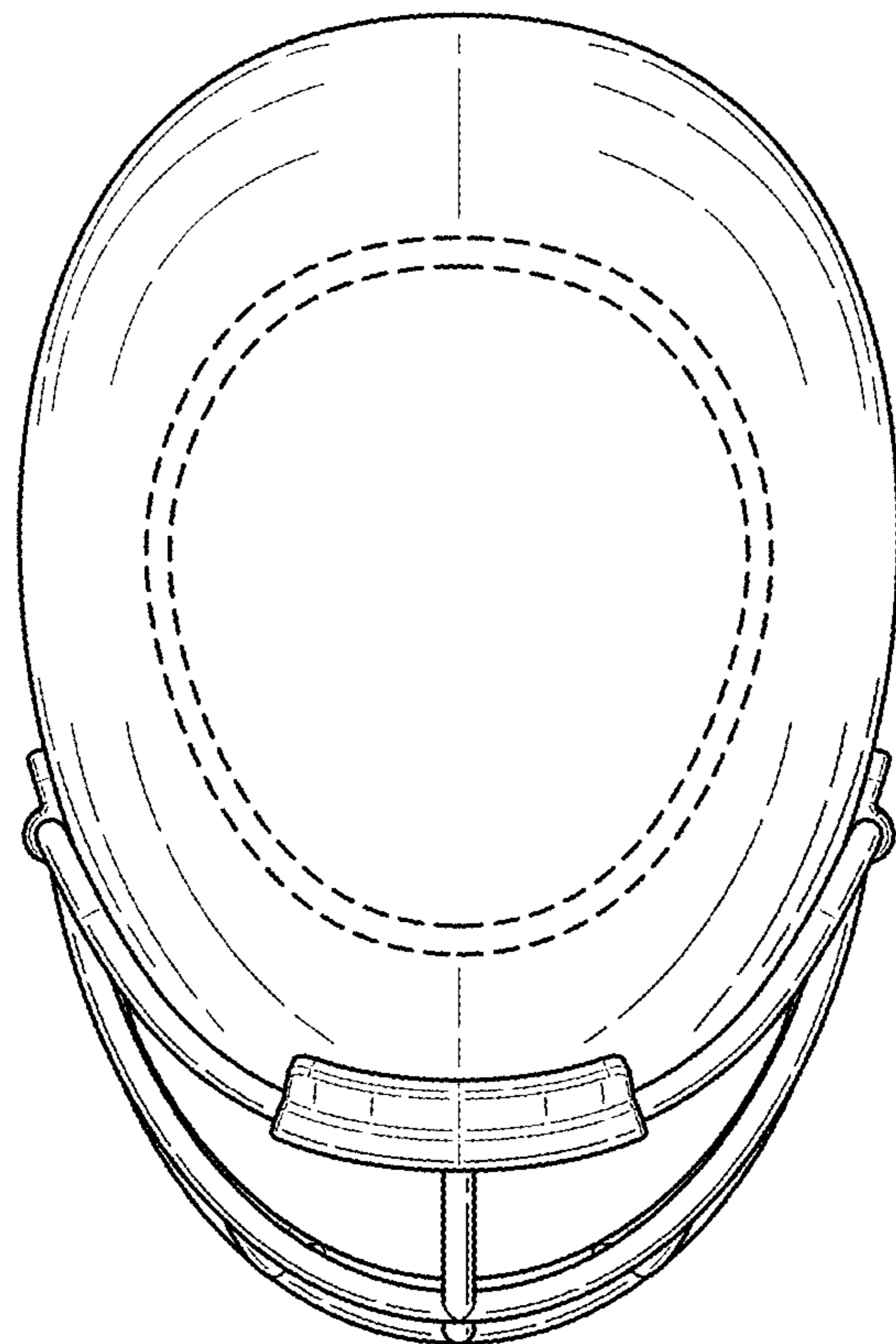

FIG. 6

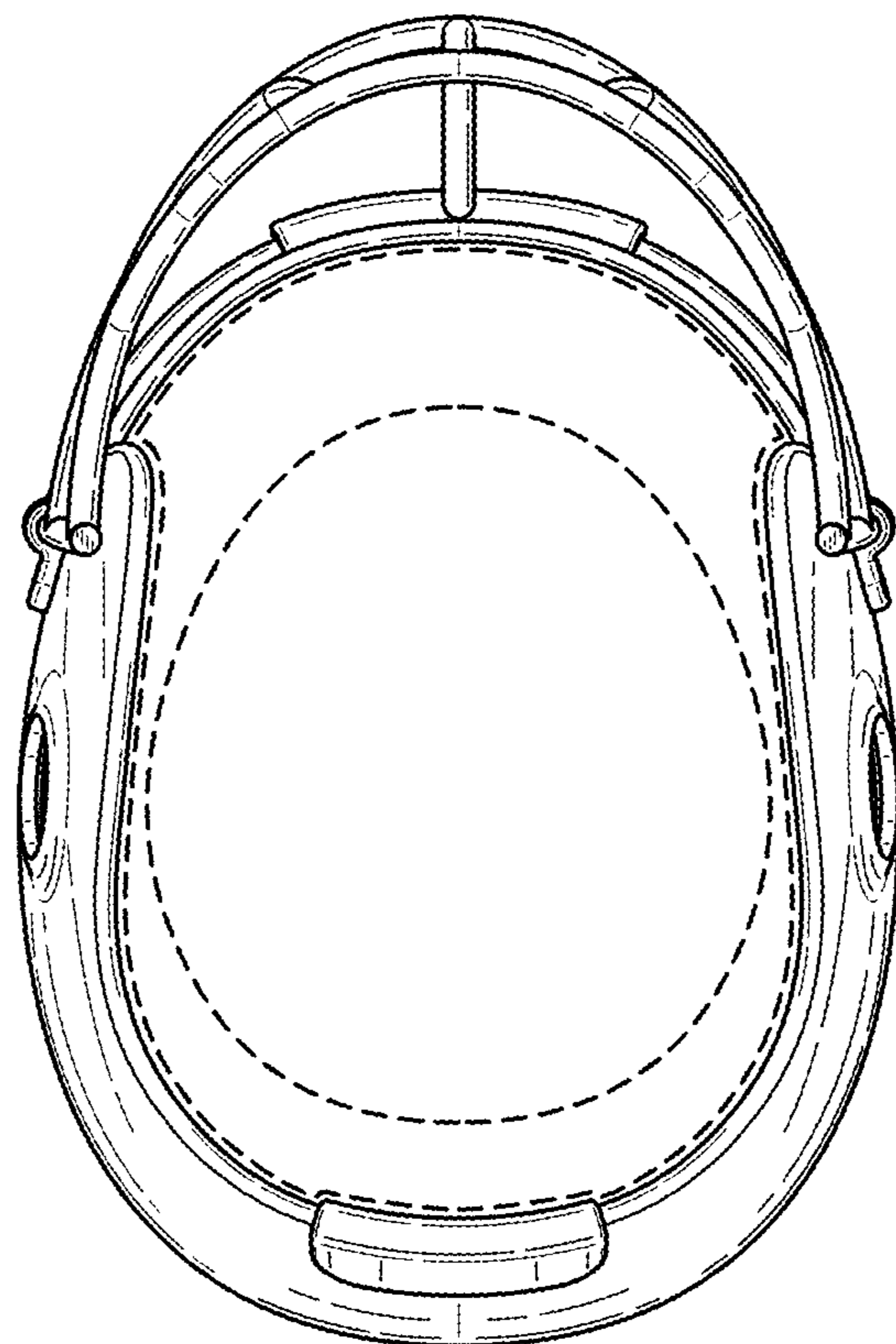

FIG. 7