



US00D775826S

(12) **United States Design Patent** (10) **Patent No.:** **US D775,826 S**
Gettel (45) **Date of Patent:** **** Jan. 10, 2017**

(54) **CASE**

(71) Applicant: **Adrian Steel Company**, Adrian, MI (US)

(72) Inventor: **Michael D. Gettel**, Adrian, MI (US)

(73) Assignee: **Adrian Steel Company**, Adrian, MI (US)

(**) Term: **15 Years**

(21) Appl. No.: **29/532,832**

(22) Filed: **Jul. 10, 2015**

(51) **LOC (10) Cl.** **03-01**

(52) **U.S. Cl.**
USPC **D3/276; D3/294; D3/905**

(58) **Field of Classification Search**
USPC D3/272, 273, 274, 276, 281, 282, 288,
D3/294, 905, 232, 239, 242, 245, 246
CPC B25H 3/00; B25H 3/02; B25H 3/003;
B25H 3/006; B25H 3/021; B25H 3/022;
B25H 3/023; B25H 3/025; B25H 3/026;
B25H 3/027; B25H 3/028; A45C
5/00; A45C 5/005; A45C 5/03; A45C
2005/037; A45C 5/08; A45C 2005/10
See application file for complete search history.

(56) **References Cited**

U.S. PATENT DOCUMENTS

D353,048	S	*	12/1994	VanSkiver	D3/273
D413,202	S	*	8/1999	Schmitt	D3/276
D441,954	S	*	5/2001	Parker	D3/273
D462,519	S	*	9/2002	Gaydos	D3/276
D467,424	S	*	12/2002	Hardigg	D3/276
D467,425	S	*	12/2002	Hardigg	D3/276
D467,426	S	*	12/2002	Hardigg	D3/276
D513,123	S	*	12/2005	Richardson	D3/273
D520,237	S	*	5/2006	Cheng	D3/276
D523,242	S	*	6/2006	Hardigg	D3/276
8,297,464	B2	*	10/2012	Grenier	A45C 13/1084 220/314

OTHER PUBLICATIONS

Amazon, "Dewalt DWST17805 TSTAK V Organizer with Clear Lid", Accessed Aug. 19, 2016, First for sale Apr. 12, 2013. (https://www.amazon.com/DEWALT-DWST17805-TSTAK-Organizer-Clear/dp/B00CBY2E6G/ref=pd_sim_sbs_469_11?ie=UTF8&psc=1&refRID=43PW89TZRHGJVZ8AABRH).*

* cited by examiner

Primary Examiner — Jennifer Rivard

Assistant Examiner — April Rivas

(74) *Attorney, Agent, or Firm* — Marshall & Melhorn, LLC

(57) **CLAIM**

The ornamental design for a case, as shown and described.

DESCRIPTION

FIG. 1 is a perspective view of an exemplary case showing our new design;
FIG. 2 is a front view thereof;
FIG. 3 is a rear view thereof;
FIG. 4 is a left side view thereof;
FIG. 5 is a right side view thereof;
FIG. 6 is a top view thereof; and
FIG. 7 is a bottom view thereof.
FIG. 8 is a perspective view of another exemplary case showing our new design;
FIG. 9 is a front view thereof;
FIG. 10 is a rear view thereof;
FIG. 11 is a left side view thereof;
FIG. 12 is a right side view thereof;
FIG. 13 is a top view thereof; and,
FIG. 14 is a bottom view thereof.
The stylized "AS" mark forming part of the claimed design is a registered trademark of Adrian Steel Company.

1 Claim, 10 Drawing Sheets

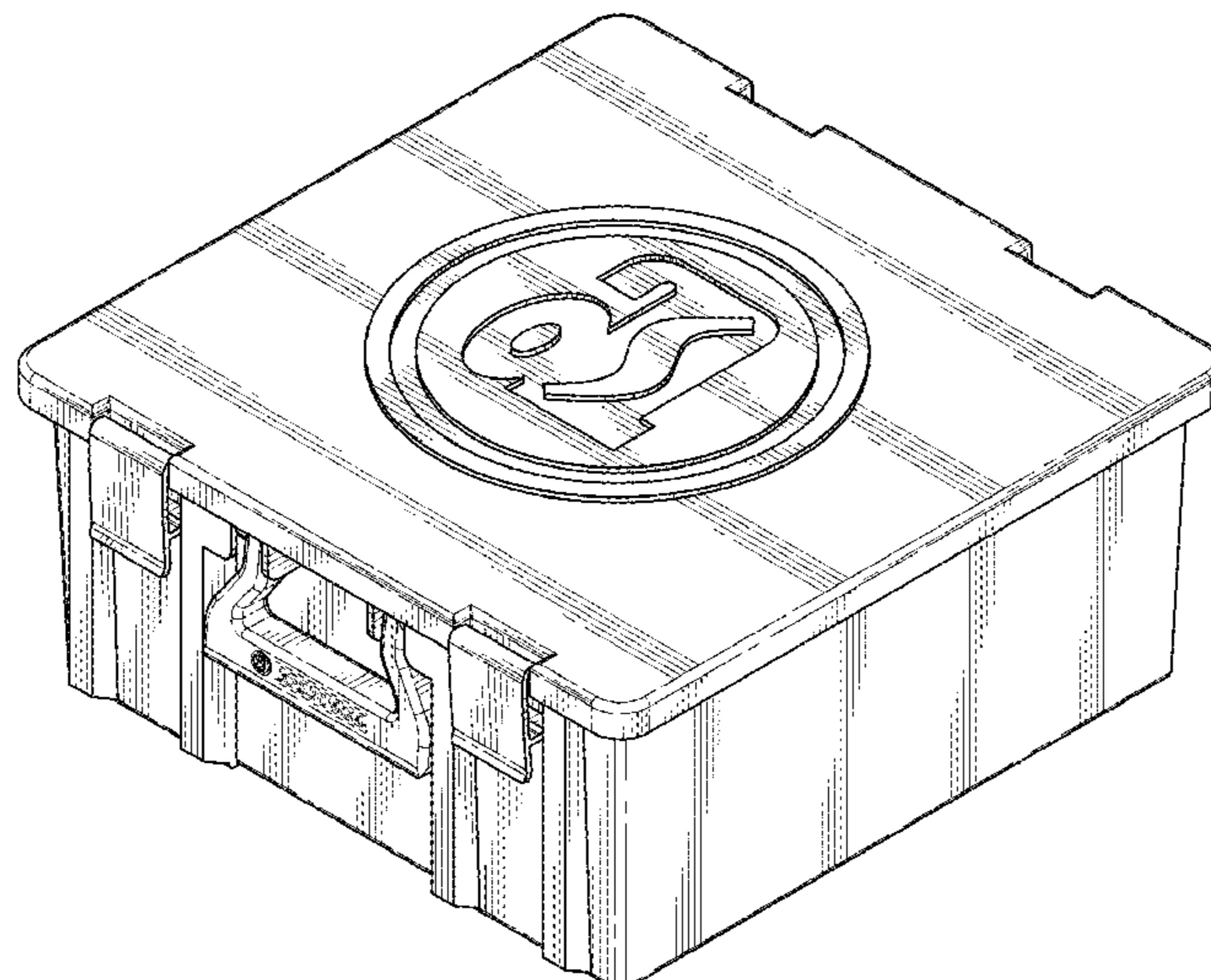

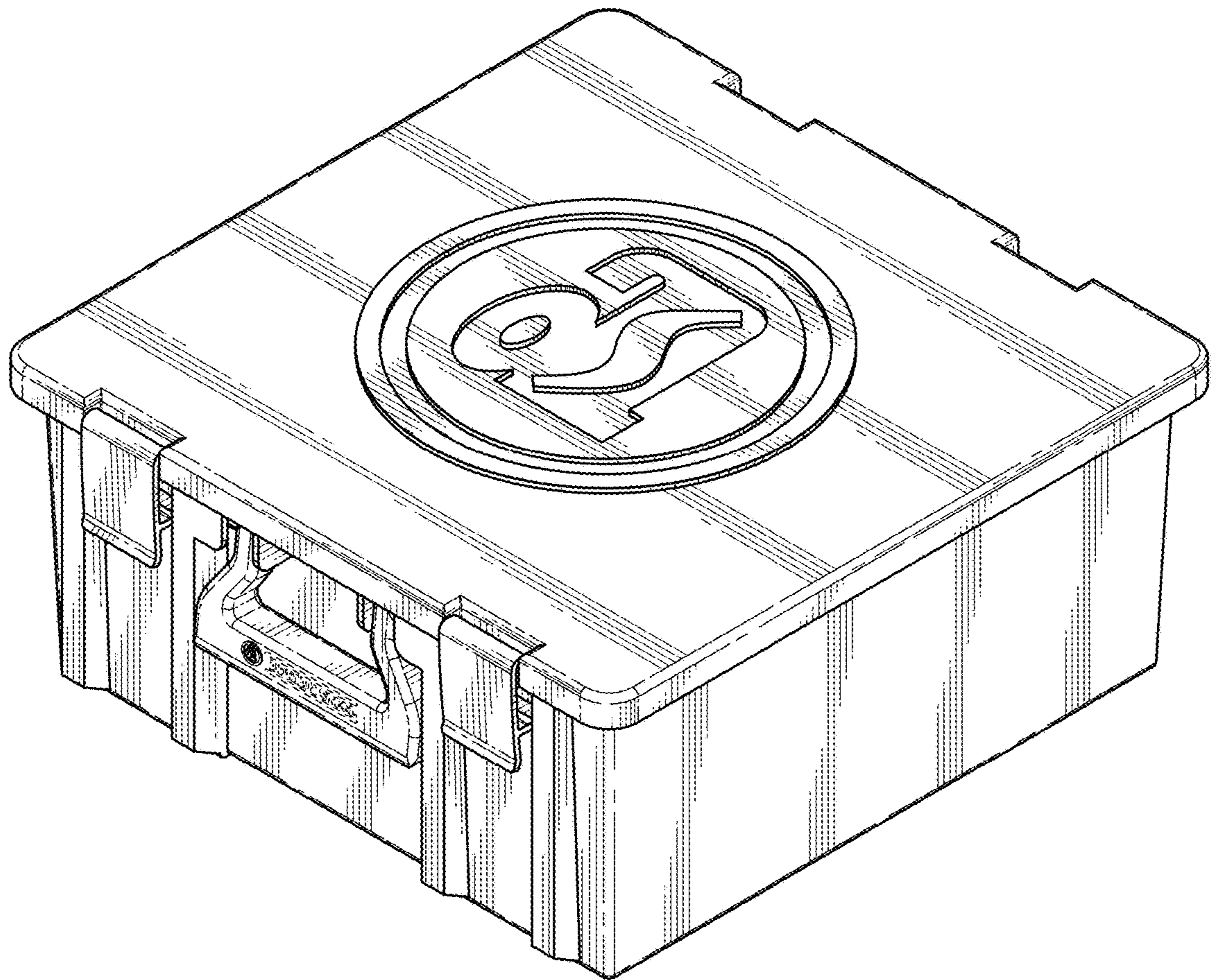

FIG. 1

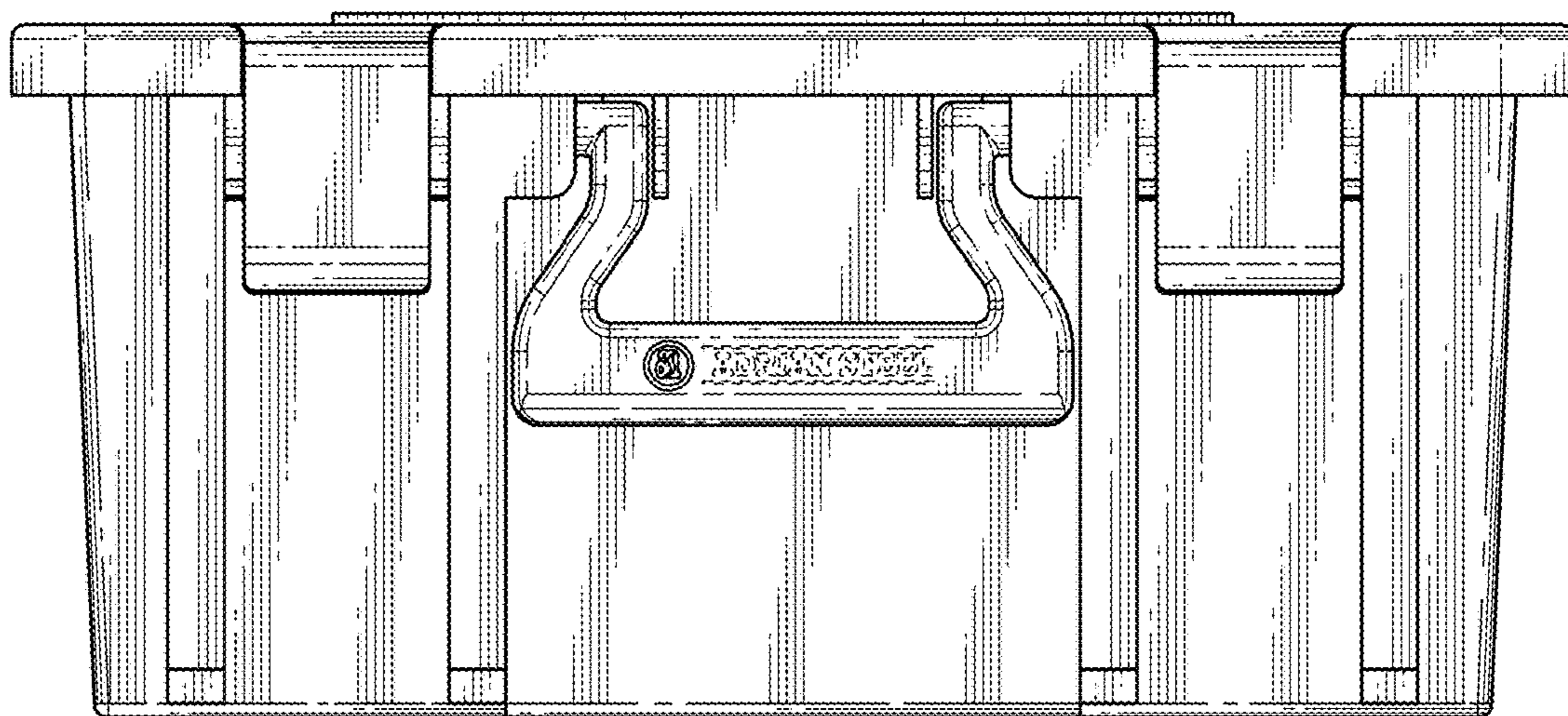

FIG. 2

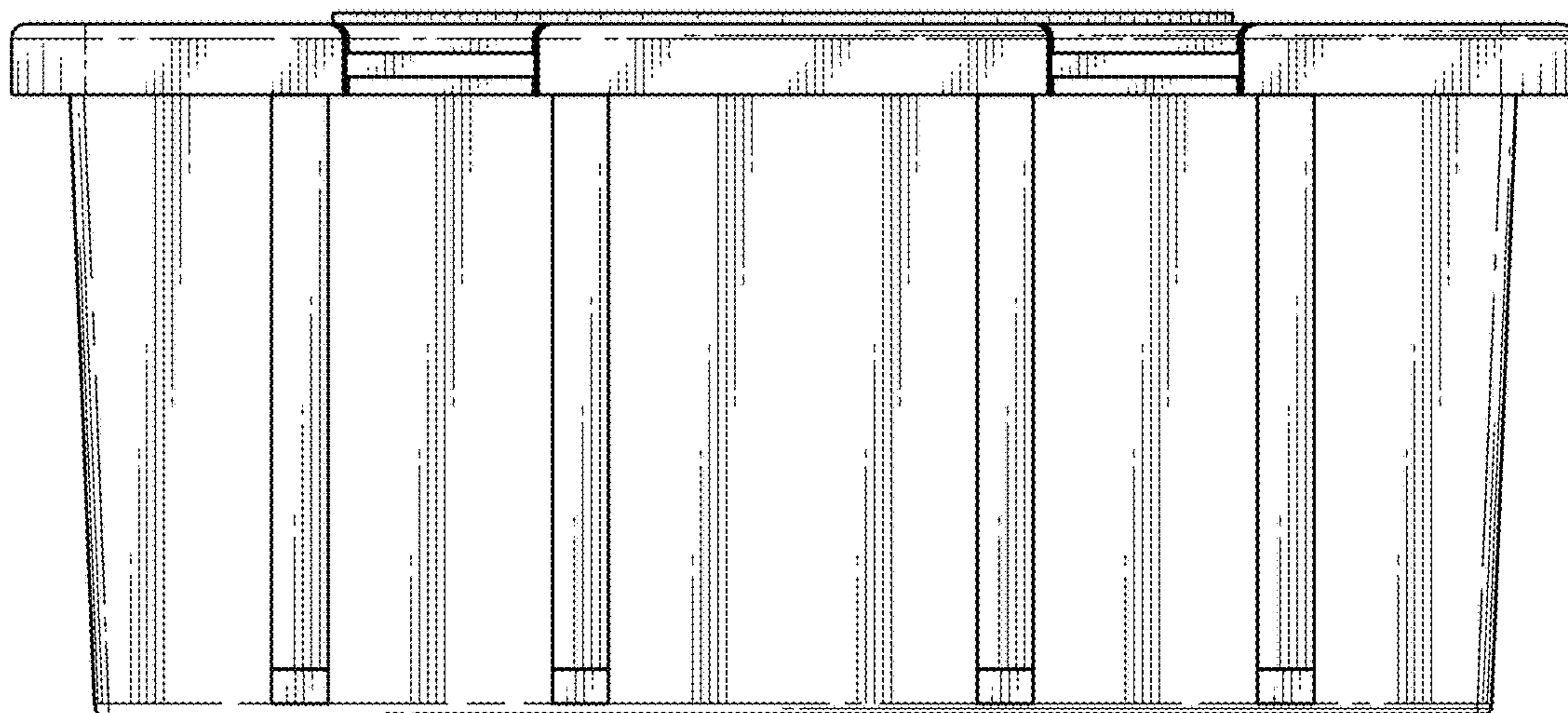

FIG. 3

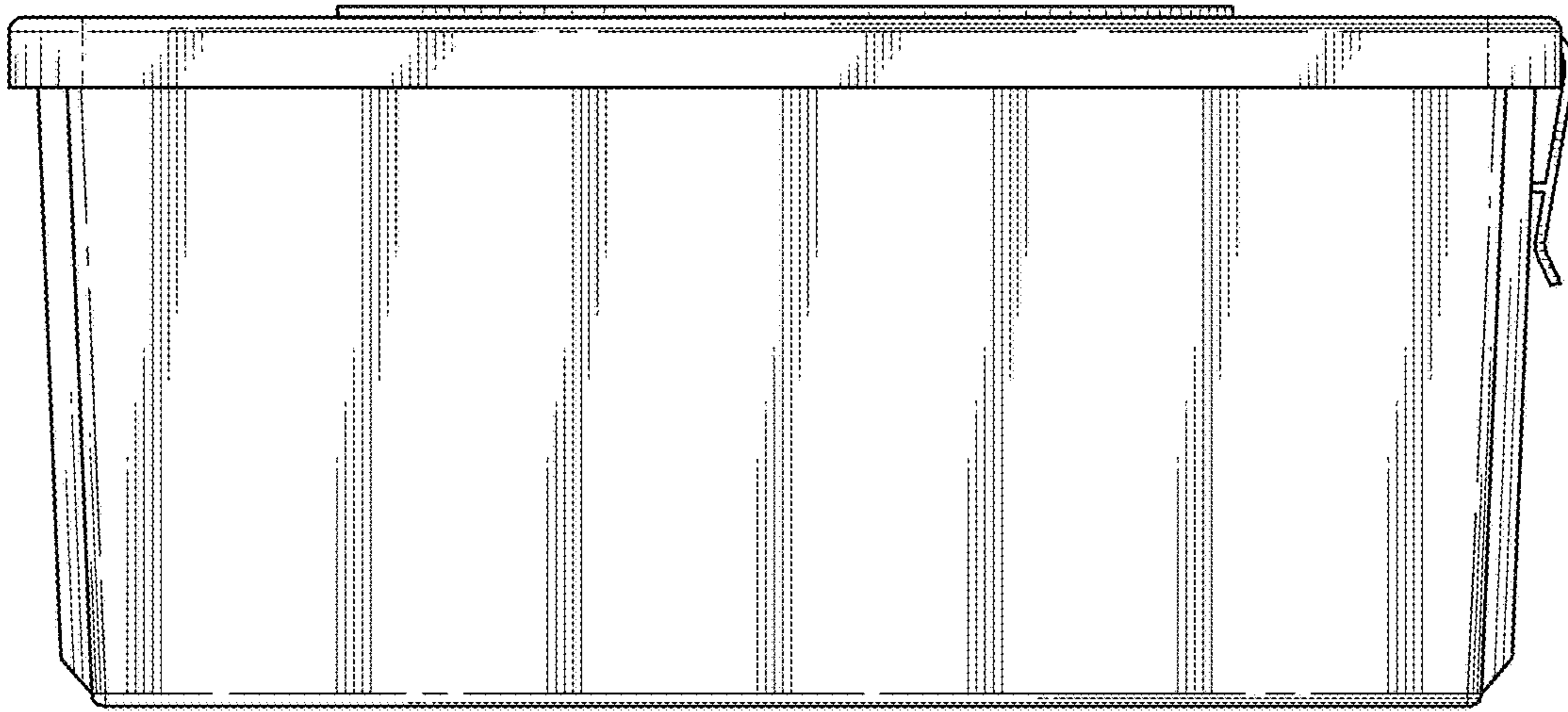

FIG. 4

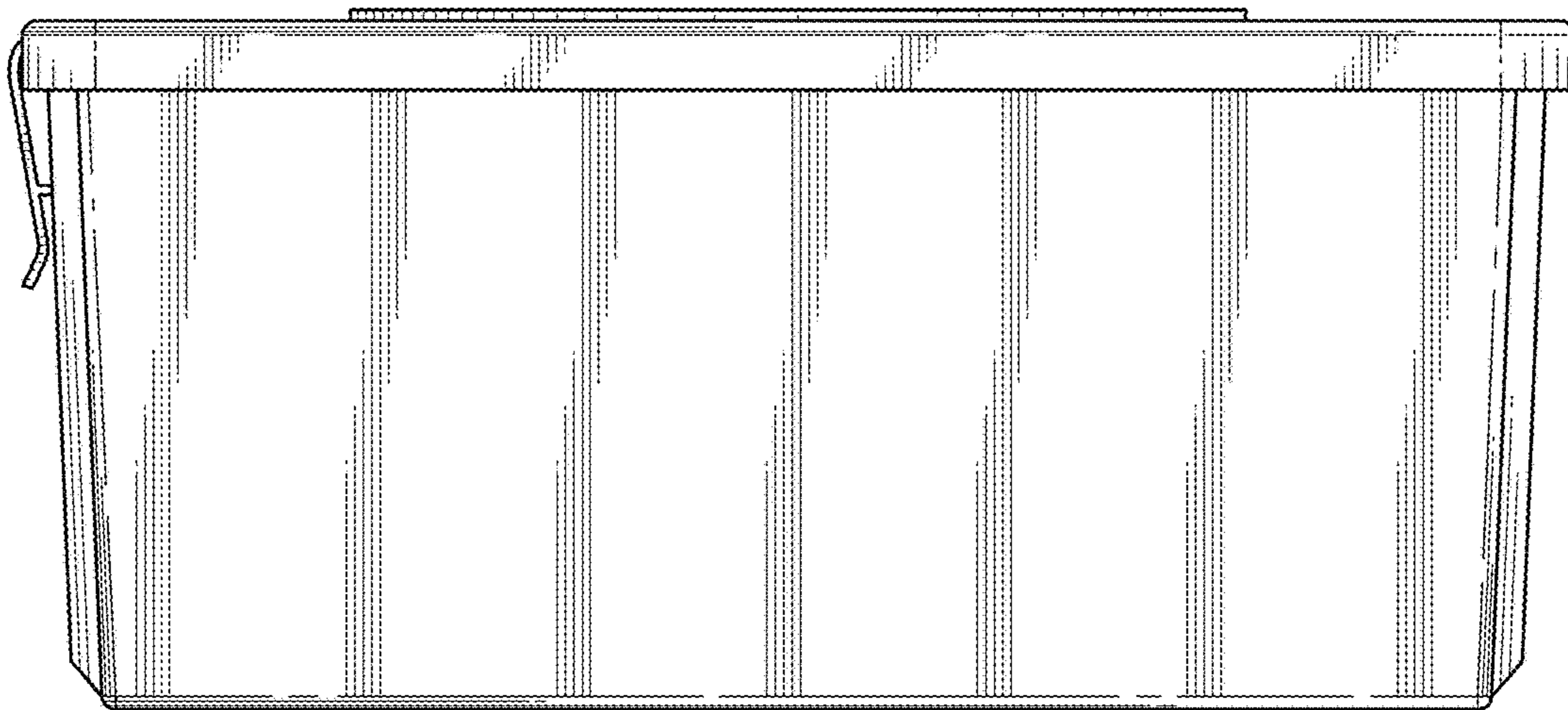

FIG. 5

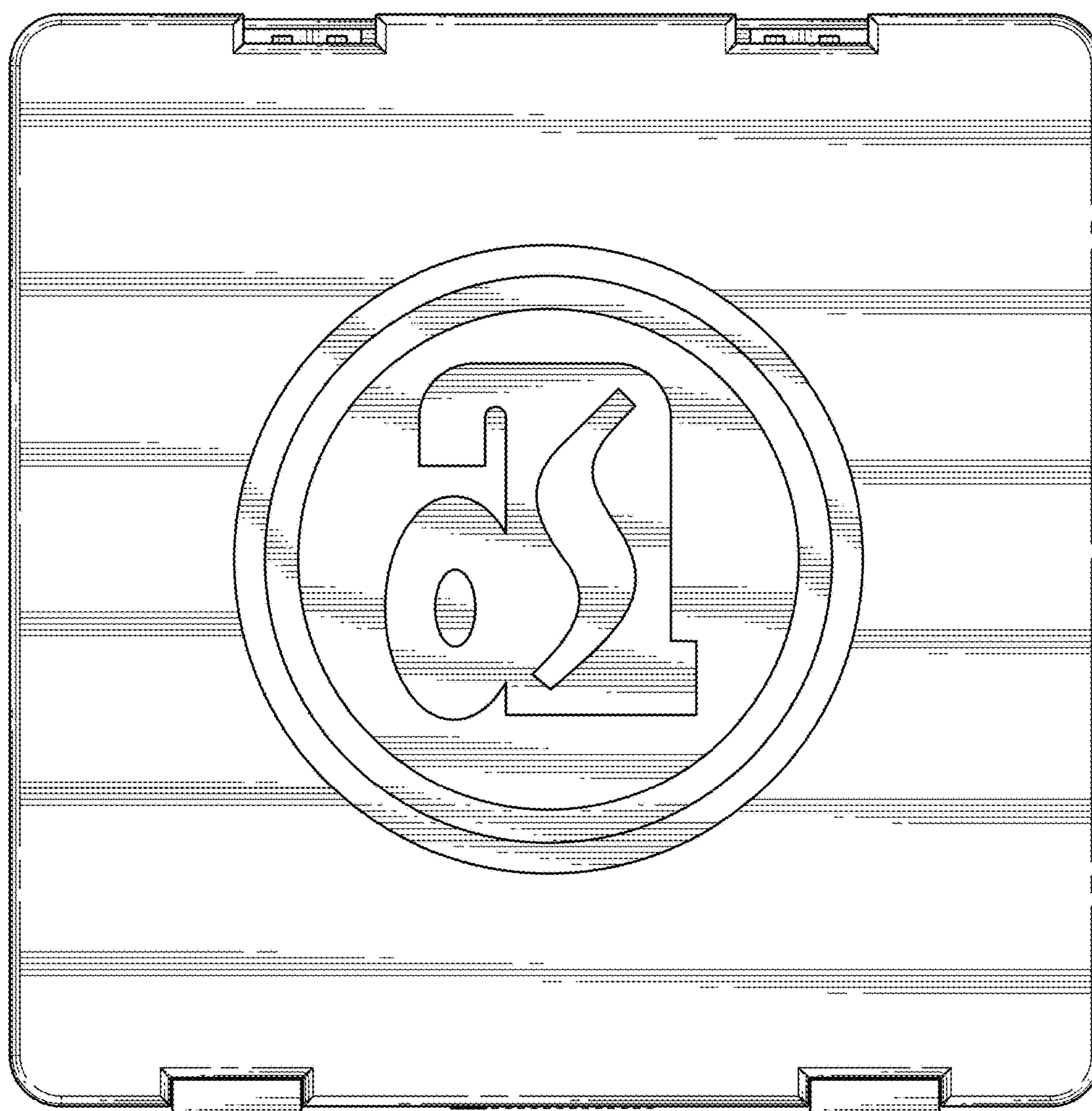

FIG. 6

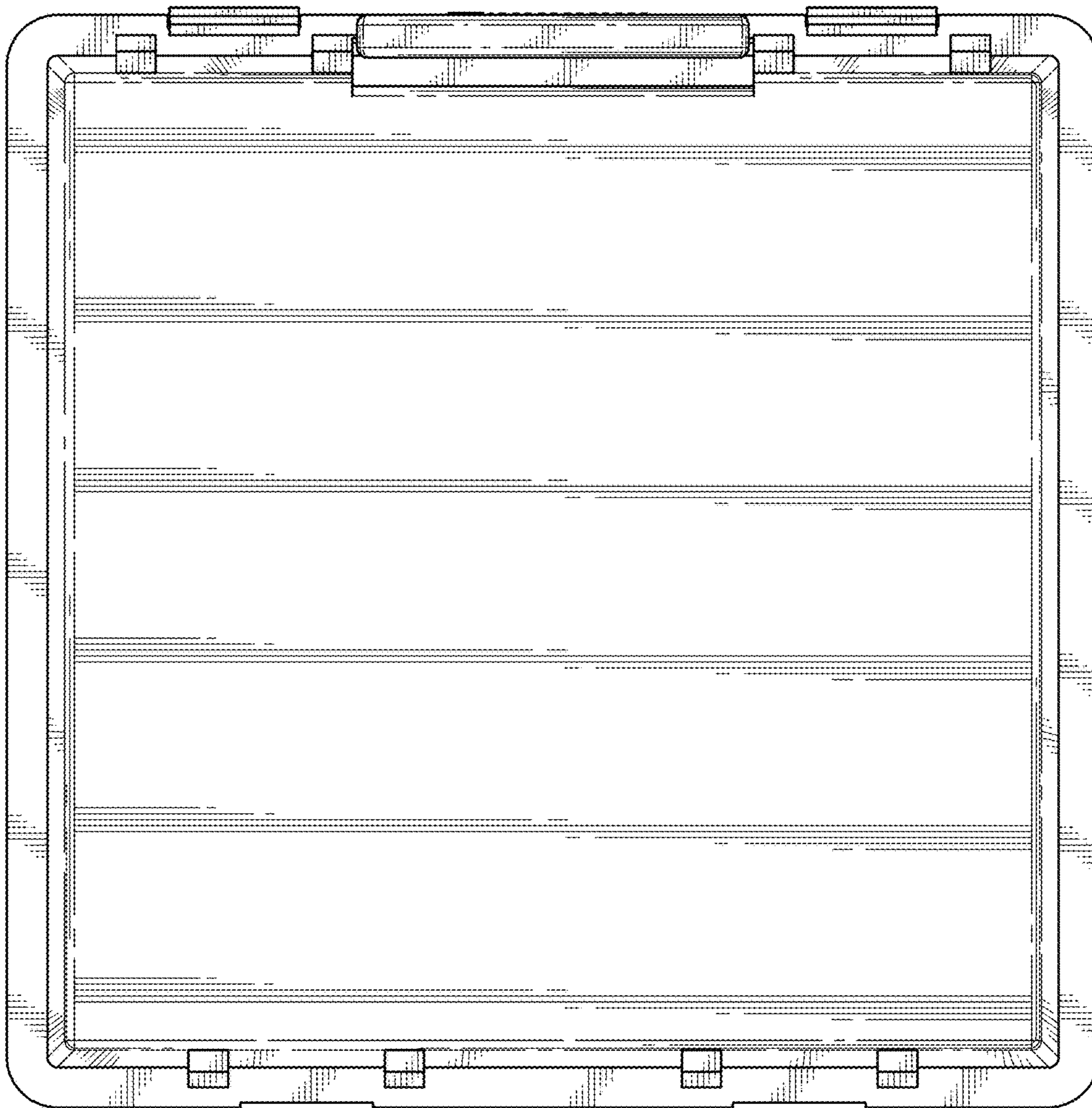

FIG. 7

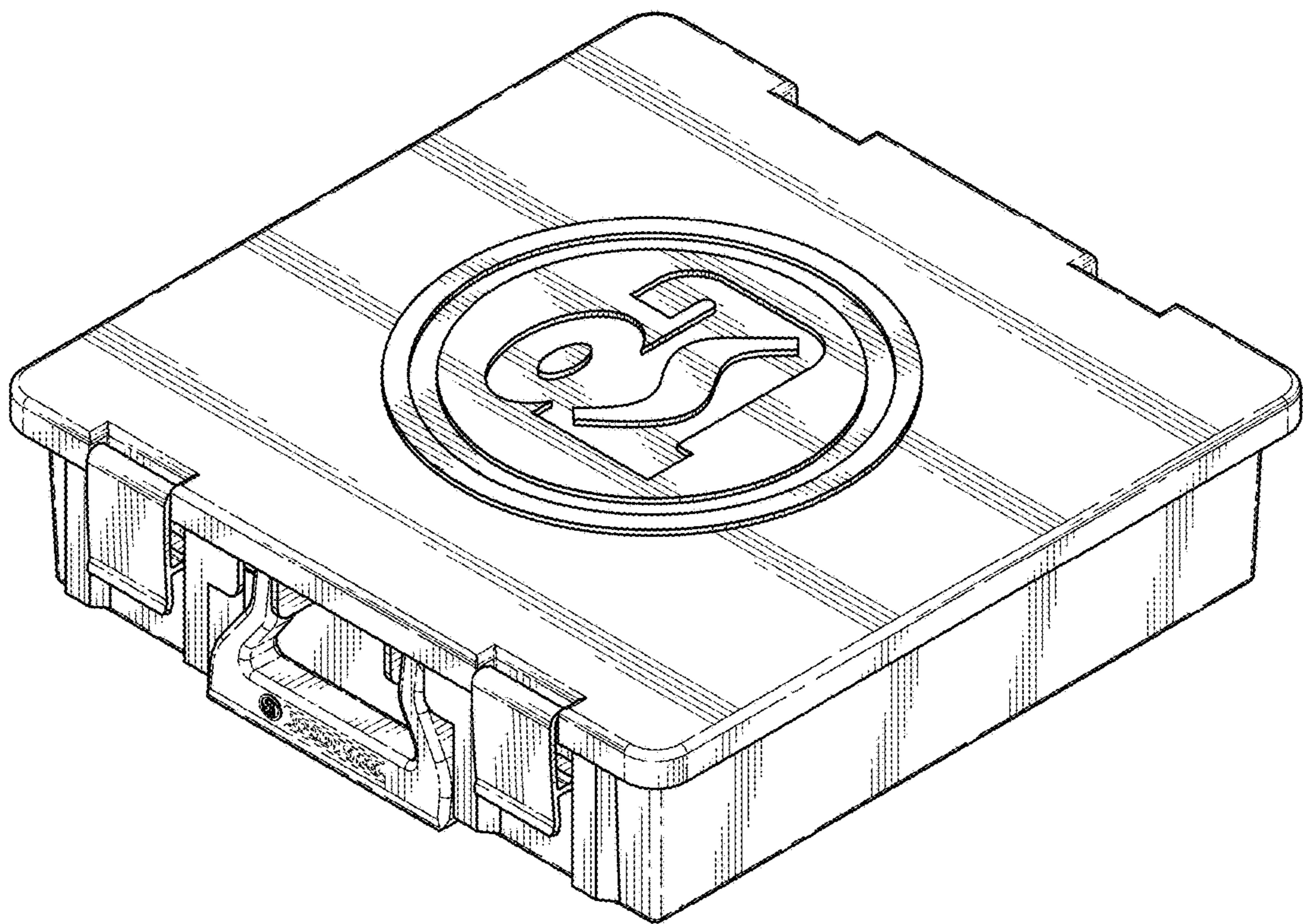

FIG. 8

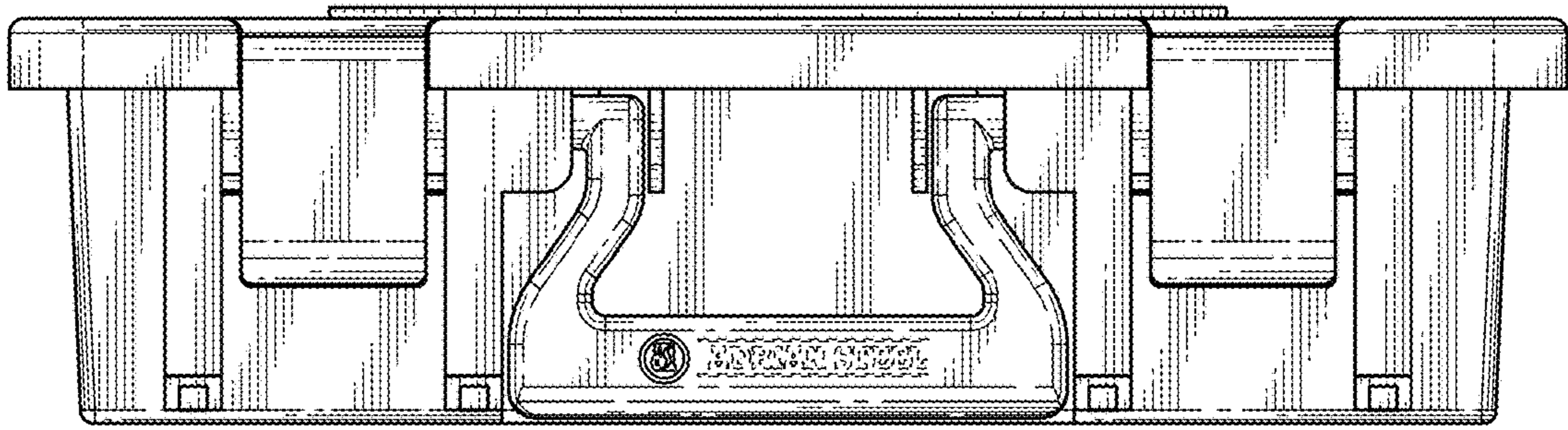

FIG. 9

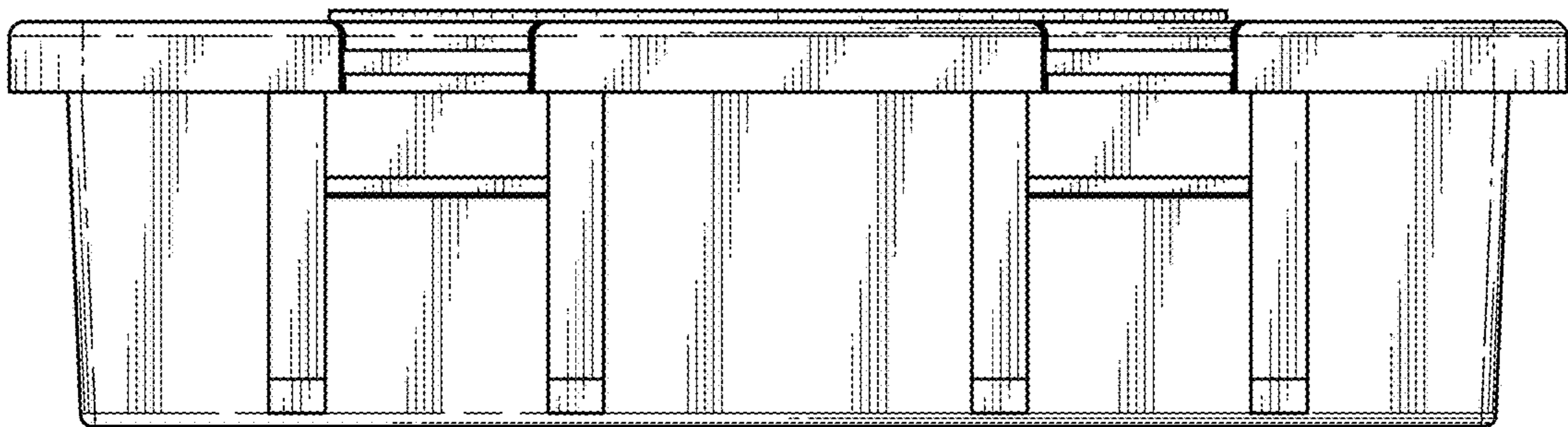

FIG. 10

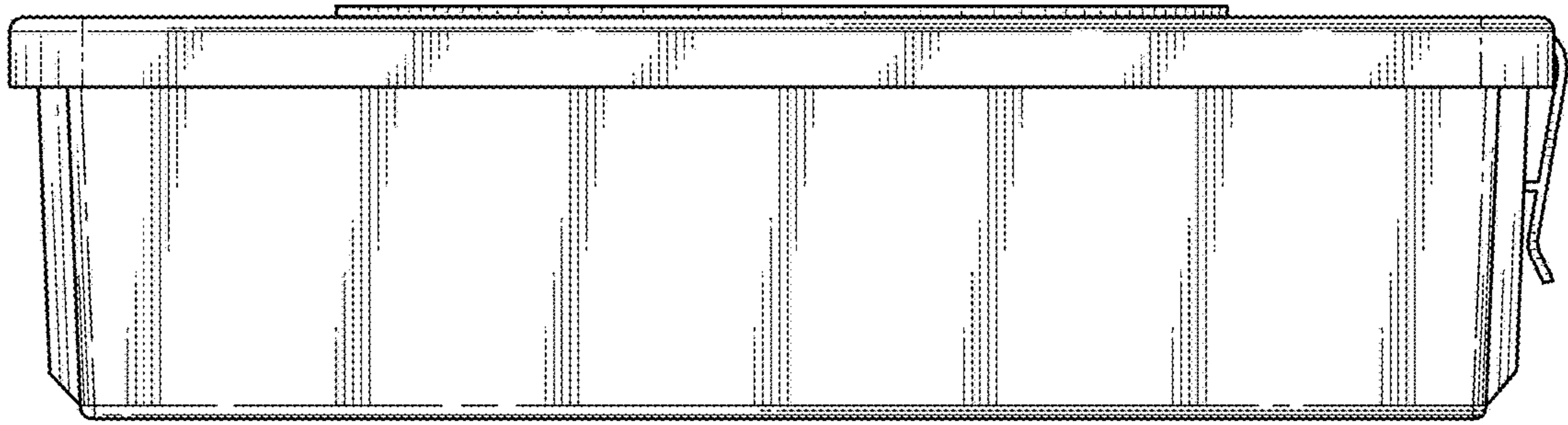

FIG. 11

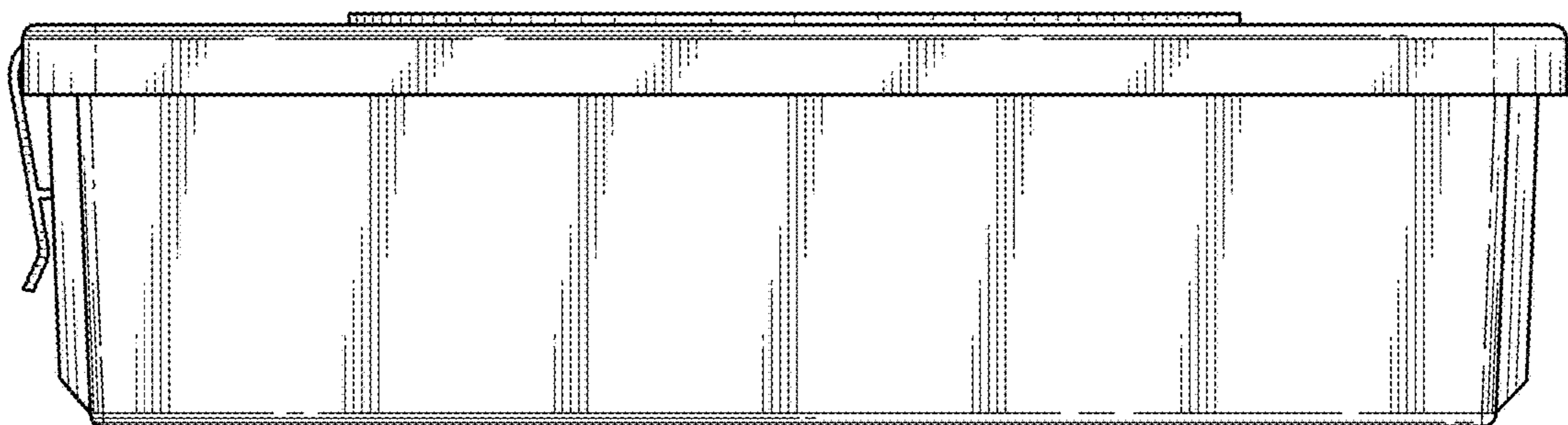

FIG. 12

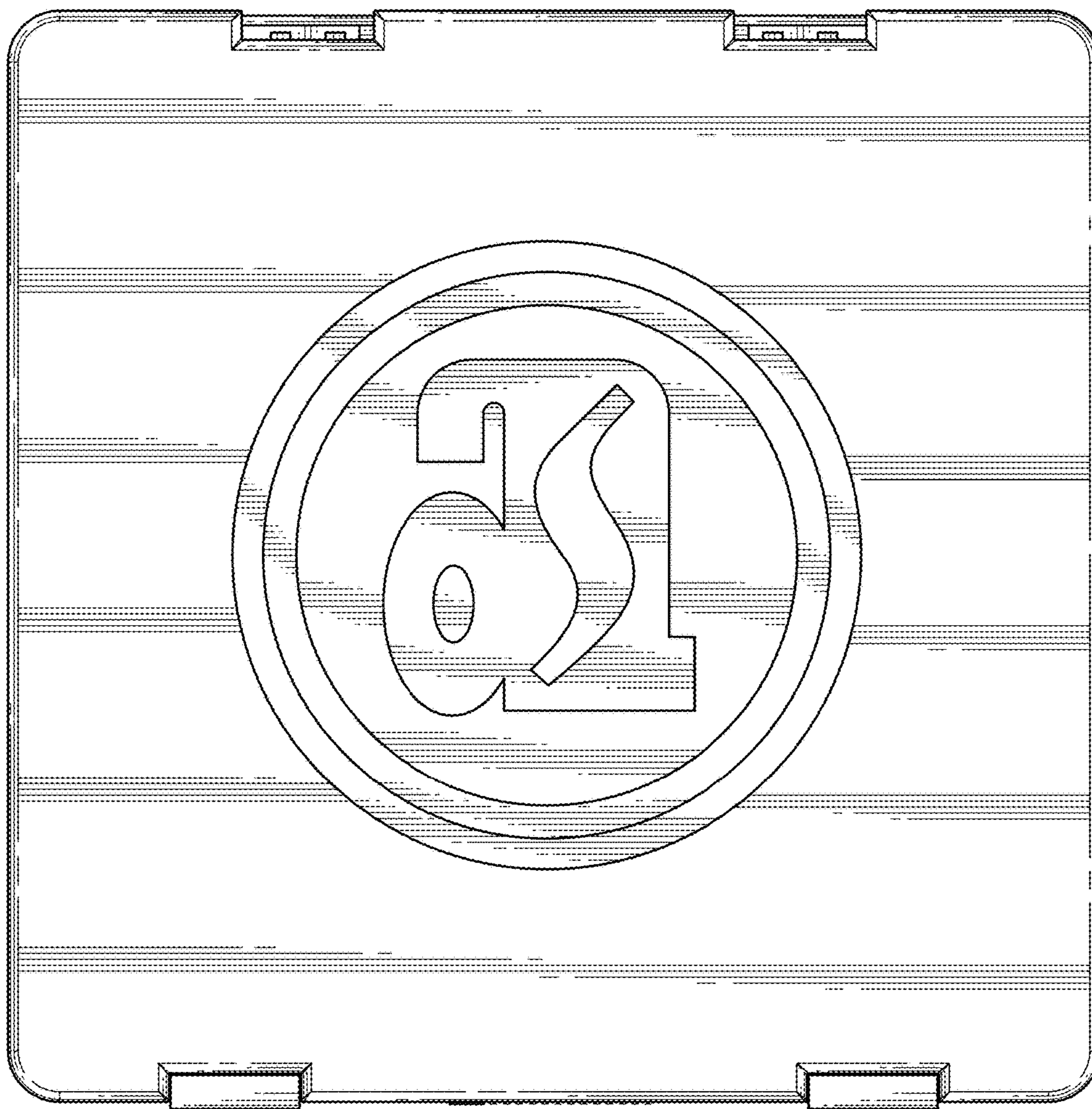

FIG. 13

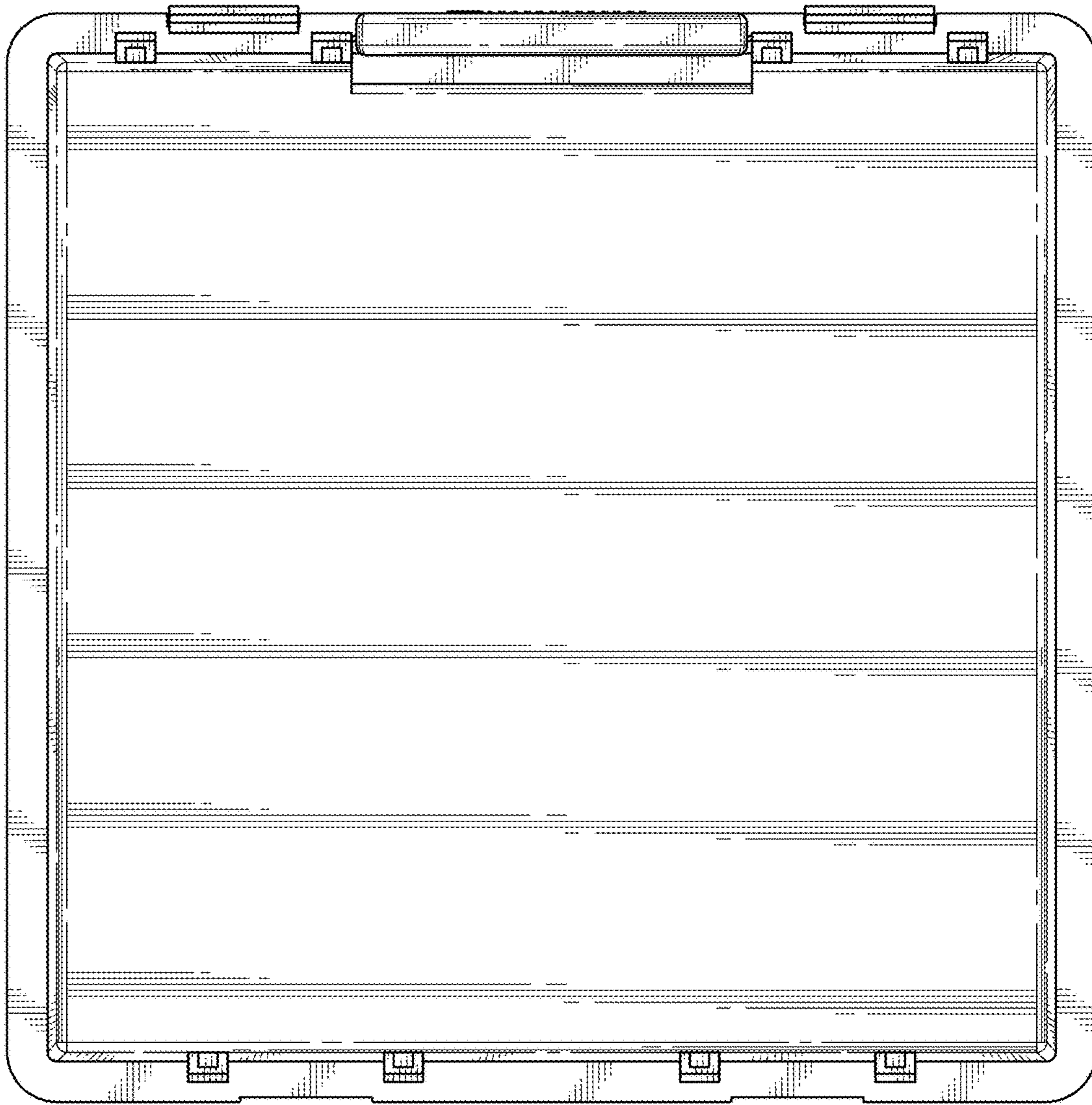

FIG. 14