



US00D775623S

(12) **United States Design Patent** (10) **Patent No.:** **US D775,623 S**
Akana et al. (45) **Date of Patent:** **** Jan. 3, 2017**

(54) **ELECTRONIC DEVICE**

(71) Applicant: **Apple Inc.**, Cupertino, CA (US)

(72) Inventors: **Jody Akana**, San Francisco, CA (US); **Bartley K. Andre**, Menlo Park, CA (US); **Jeremy Bataillou**, San Francisco, CA (US); **Daniel J. Coster**, San Francisco, CA (US); **Daniele De Iuliis**, San Francisco, CA (US); **M. Evans Hankey**, San Francisco, CA (US); **Julian Hoenig**, San Francisco, CA (US); **Richard P. Howarth**, San Francisco, CA (US); **Jonathan P. Ive**, San Francisco, CA (US); **Duncan Robert Kerr**, San Francisco, CA (US); **Matthew Dean Rohrbach**, San Francisco, CA (US); **Peter Russell-Clarke**, San Francisco, CA (US); **Mikael Silvanto**, San Francisco, CA (US); **Christopher J. Stringer**, Woodside, CA (US); **Eugene Antony Whang**, San Francisco, CA (US); **Rico Zörkendörfer**, San Francisco, CA (US)

(73) Assignee: **Apple Inc.**, Cupertino, CA (US)

(**) Term: **14 Years**

(21) Appl. No.: **29/492,411**

(22) Filed: **May 30, 2014**

Related U.S. Application Data

(60) Continuation of application No. 29/464,931, filed on Aug. 22, 2013, which is a continuation of application (Continued)

(51) **LOC (10) Cl.** **14-02**

(52) **U.S. Cl.**
USPC **D14/315**

(58) **Field of Classification Search**
USPC . D14/315-327; D18/1, 2, 7, 11; 235/145 A, 235/145 R; 341/22, 23; 345/104, 156, 345/168, 169, 173; 361/679.08, 679.09, 361/679.11, 679.26, 679.27
(Continued)

(56) **References Cited**
U.S. PATENT DOCUMENTS

5,694,292 A 12/1997 Paulsel et al.
5,694,294 A 12/1997 Ohashi et al.
(Continued)

Primary Examiner — Freda S Nunn
(74) *Attorney, Agent, or Firm* — Saidman DesignLaw Group, LLC

(57) **CLAIM**

The ornamental design for an electronic device, as shown and described.

DESCRIPTION

FIG. 1 is a top, front perspective view of an electronic device showing our new design;
FIG. 2 is a bottom, rear perspective thereof;
FIG. 3 is front view thereof;
FIG. 4 is rear view thereof;
FIG. 5 is a left side view thereof;
FIG. 6 is a right side view thereof;
FIG. 7 is a top view thereof;
FIG. 8 is a bottom view thereof;
FIG. 9 is an additional top, front perspective view thereof, with the electronic device shown in an open position;
FIG. 10 is an additional bottom, rear perspective view thereof, with the electronic device shown in an open position;

(Continued)

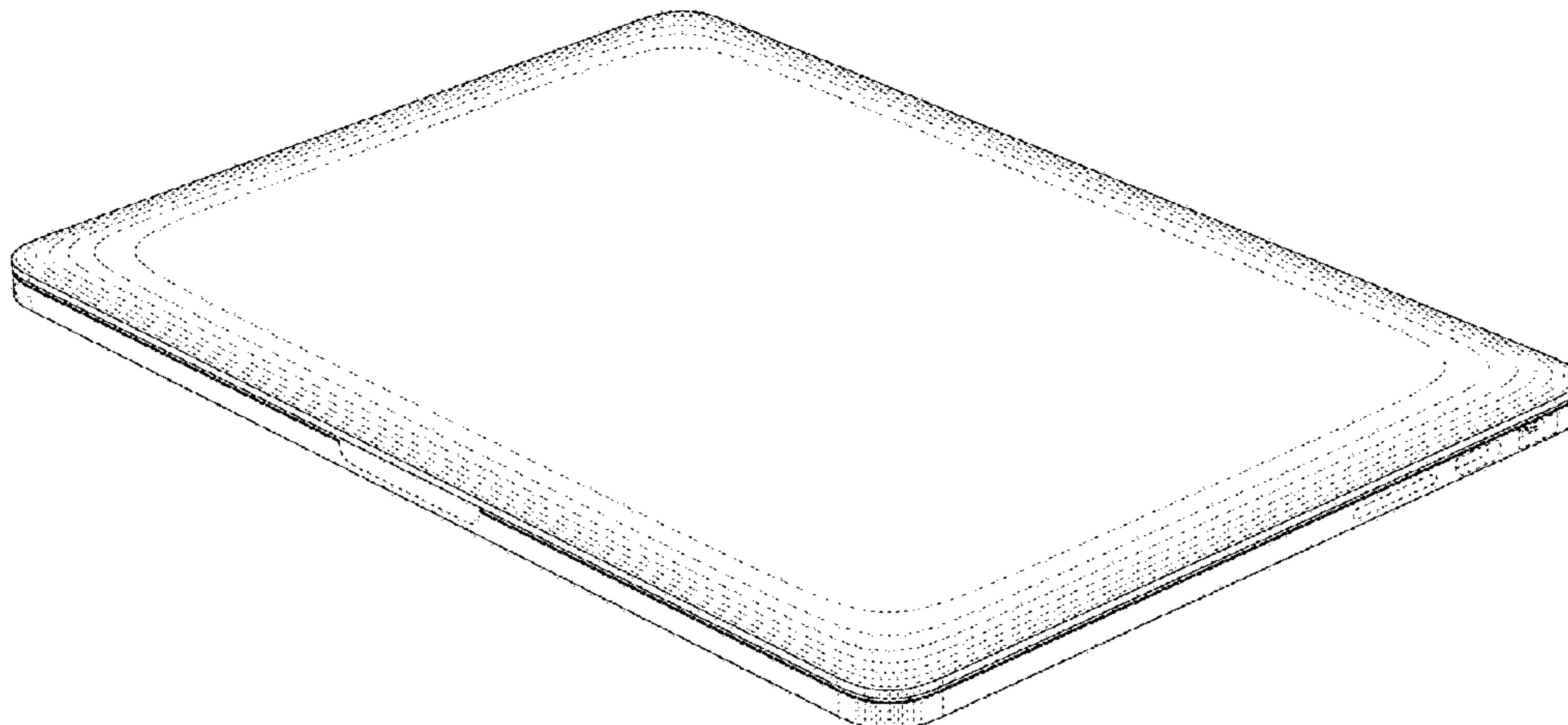

FIG. 11 is an additional front view thereof, with the electronic device shown in an open position;
 FIG. 12 is an additional rear view thereof, with the electronic device shown in an open position;
 FIG. 13 is an additional left side view thereof, with the electronic device shown in an open position;
 FIG. 14 is an additional right side view thereof, with the electronic device shown in an open position;
 FIG. 15 is an additional top view thereof, with the electronic device shown in an open position;
 FIG. 16 is an additional bottom view thereof, with the electronic device shown in an open position;
 FIG. 17 is a top, front perspective view of a second embodiment of an electronic device showing our new design;
 FIG. 18 is a bottom, rear perspective thereof;
 FIG. 19 is front view thereof;
 FIG. 20 is rear view thereof;
 FIG. 21 is a left side view thereof;
 FIG. 22 is a right side view thereof;
 FIG. 23 is a top view thereof;
 FIG. 24 is a bottom view thereof;
 FIG. 25 is an additional top, front perspective view thereof, with the electronic device shown in an open position;
 FIG. 26 is an additional bottom, rear perspective view thereof, with the electronic device shown in an open position;
 FIG. 27 is an additional front view thereof, with the electronic device shown in an open position;
 FIG. 28 is an additional rear view thereof, with the electronic device shown in an open position;
 FIG. 29 is an additional left side view thereof, with the electronic device shown in an open position;
 FIG. 30 is an additional right side view thereof, with the electronic device shown in an open position;
 FIG. 31 is an additional top view thereof, with the electronic device shown in an open position; and,
 FIG. 32 is an additional bottom view thereof, with the electronic device shown in an open position.
 The broken lines illustrate environmental structure and form no part of the claimed design.

1 Claim, 24 Drawing Sheets

Related U.S. Application Data

No. 29/443,018, filed on Jan. 11, 2013, now Pat. No. Des. 691,129, which is a division of application No. 29/424,261, filed on Jun. 8, 2012, now Pat. No. Des.

676,437, which is a continuation of application No. 29/420,873, filed on May 14, 2012, now Pat. No. Des. 676,438.

(58) **Field of Classification Search**

CPC G06F 1/16; G06F 1/1616; G06F 1/1626; G06F 1/1632; H01R 35/02; H03M 11/00; G09B 13/04; H03K 17/94

See application file for complete search history.

(56) **References Cited**

U.S. PATENT DOCUMENTS

5,713,790	A	2/1998	Lin
6,038,128	A	3/2000	Hood et al.
6,067,224	A	5/2000	Nobuchi
D431,821	S	10/2000	Mizuno
D493,785	S	8/2004	Andre et al.
D517,063	S	3/2006	Nakajima et al.
D523,429	S	6/2006	Lin
D524,306	S	7/2006	Yun et al.
D526,999	S	8/2006	Tago
D533,550	S	12/2006	Yamada
D571,364	S	6/2008	Andre et al.
D572,246	S	7/2008	Andre et al.
7,426,113	B2	9/2008	Ikeno et al.
D604,290	S	11/2009	Andre et al.
D604,291	S	11/2009	Andre et al.
D604,292	S	11/2009	Andre et al.
D604,293	S	11/2009	Andre et al.
D606,988	S	12/2009	Andre et al.
D606,989	S	12/2009	Andre et al.
D611,045	S	3/2010	Andre et al.
D617,789	S	6/2010	Akana et al.
D621,825	S	8/2010	Andre et al.
D623,645	S	9/2010	Andre et al.
D633,087	S	2/2011	Andre et al.
D642,172	S	7/2011	Akana et al.
D642,560	S	8/2011	Akana et al.
D648,333	S	11/2011	Andre et al.
D648,334	S	11/2011	Andre et al.
D652,032	S	1/2012	Akana et al.
D655,704	S	3/2012	Akana et al.
D657,786	S	4/2012	Andre et al.
D661,296	S	6/2012	Akana et al.
D662,497	S	6/2012	Akana et al.
D676,437	S	2/2013	Akana et al.
D676,438	S	2/2013	Akana et al.
D686,205	S	7/2013	Akana et al.
D691,128	S	10/2013	Akana et al.
D691,129	S	10/2013	Akana et al.
2005/0018396	A1	1/2005	Nakajima et al.
2005/0041378	A1	2/2005	Hamada et al.
2008/0074833	A1	3/2008	Chien et al.
2009/0040708	A1	2/2009	Tatsukami et al.
2012/0099263	A1*	4/2012	Lin 361/679.09

* cited by examiner

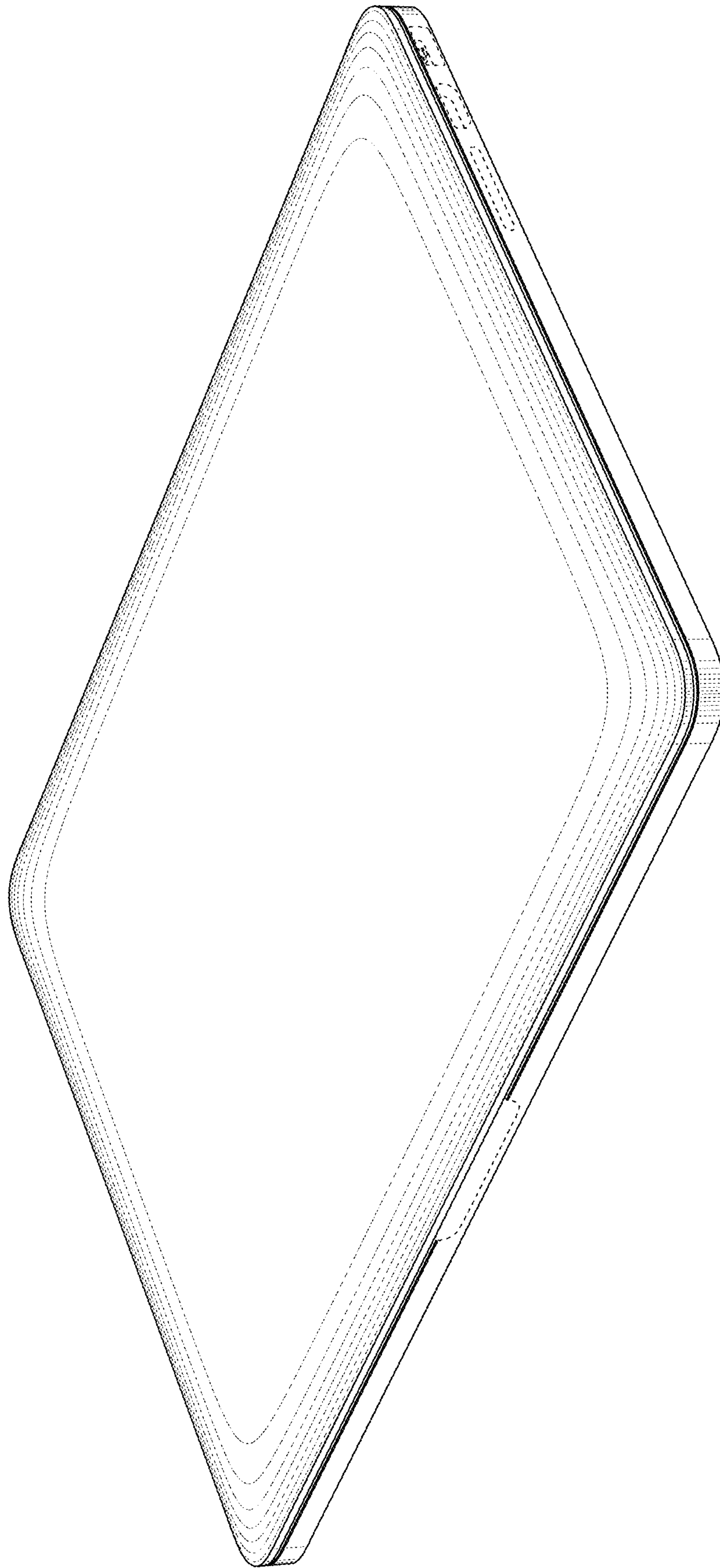

Fig. 1

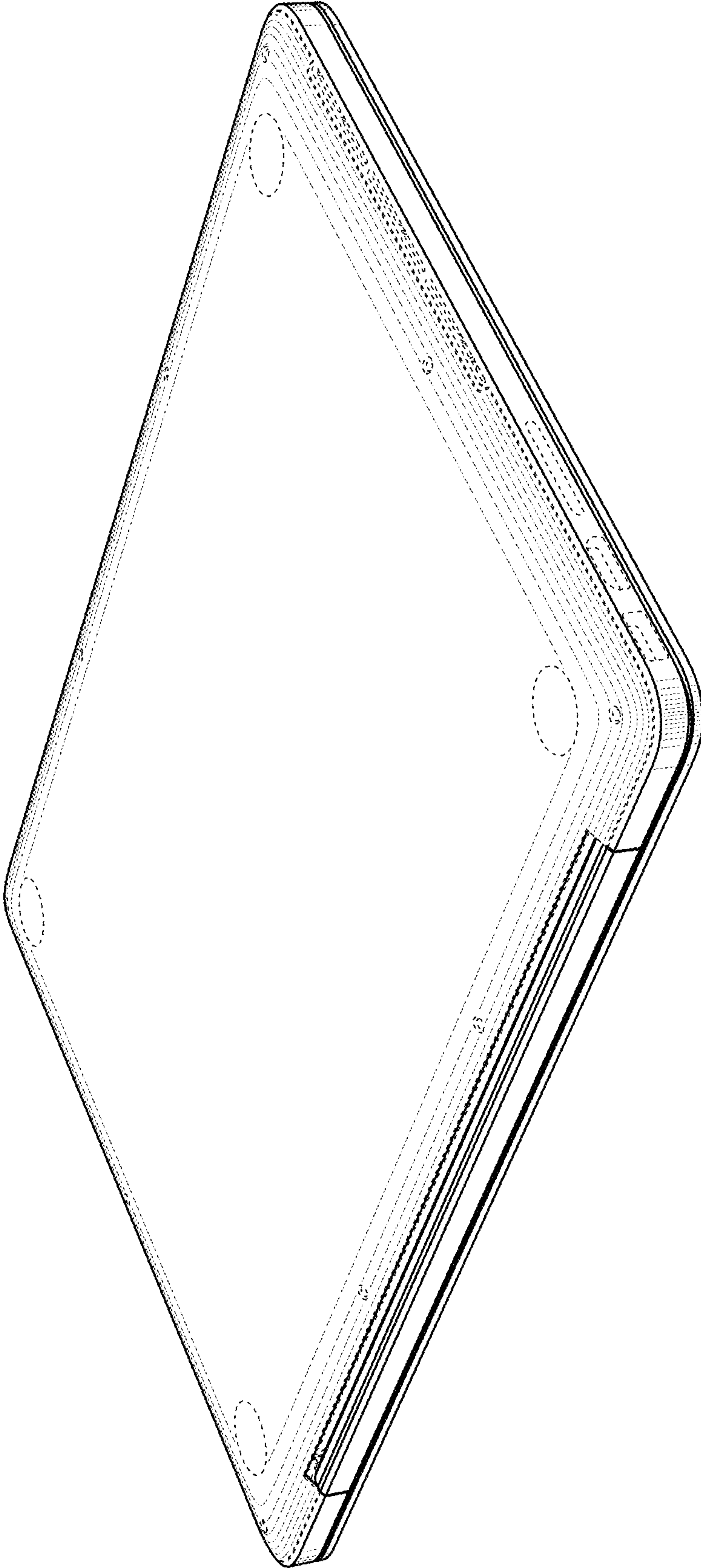

Fig. 2

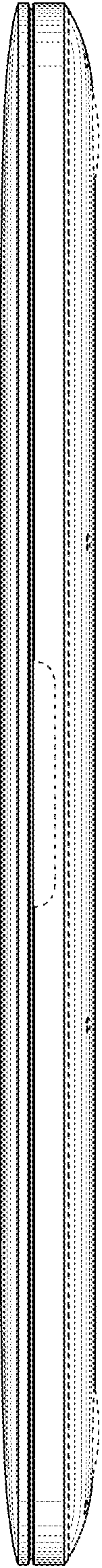

Fig. 3

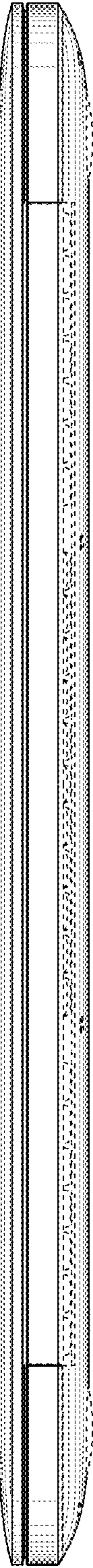

Fig. 4

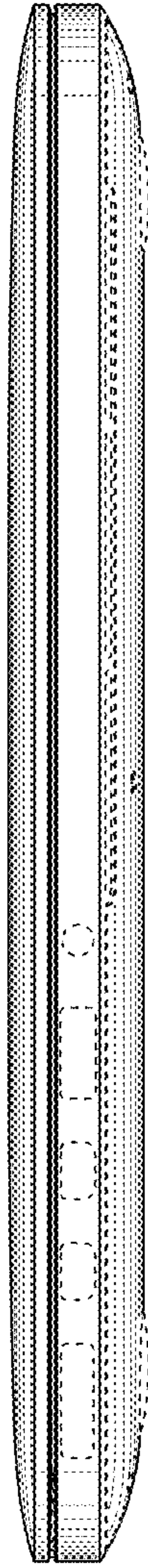

Fig. 5

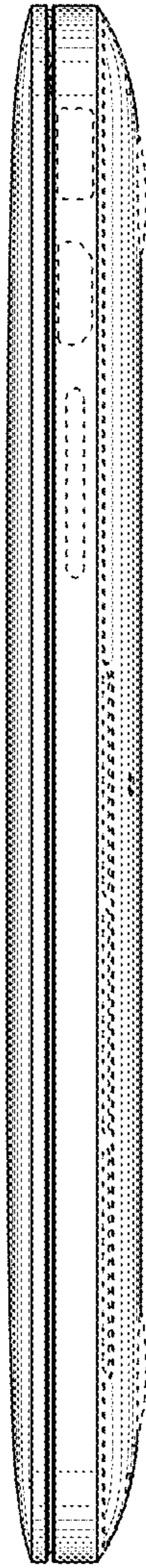

Fig. 6

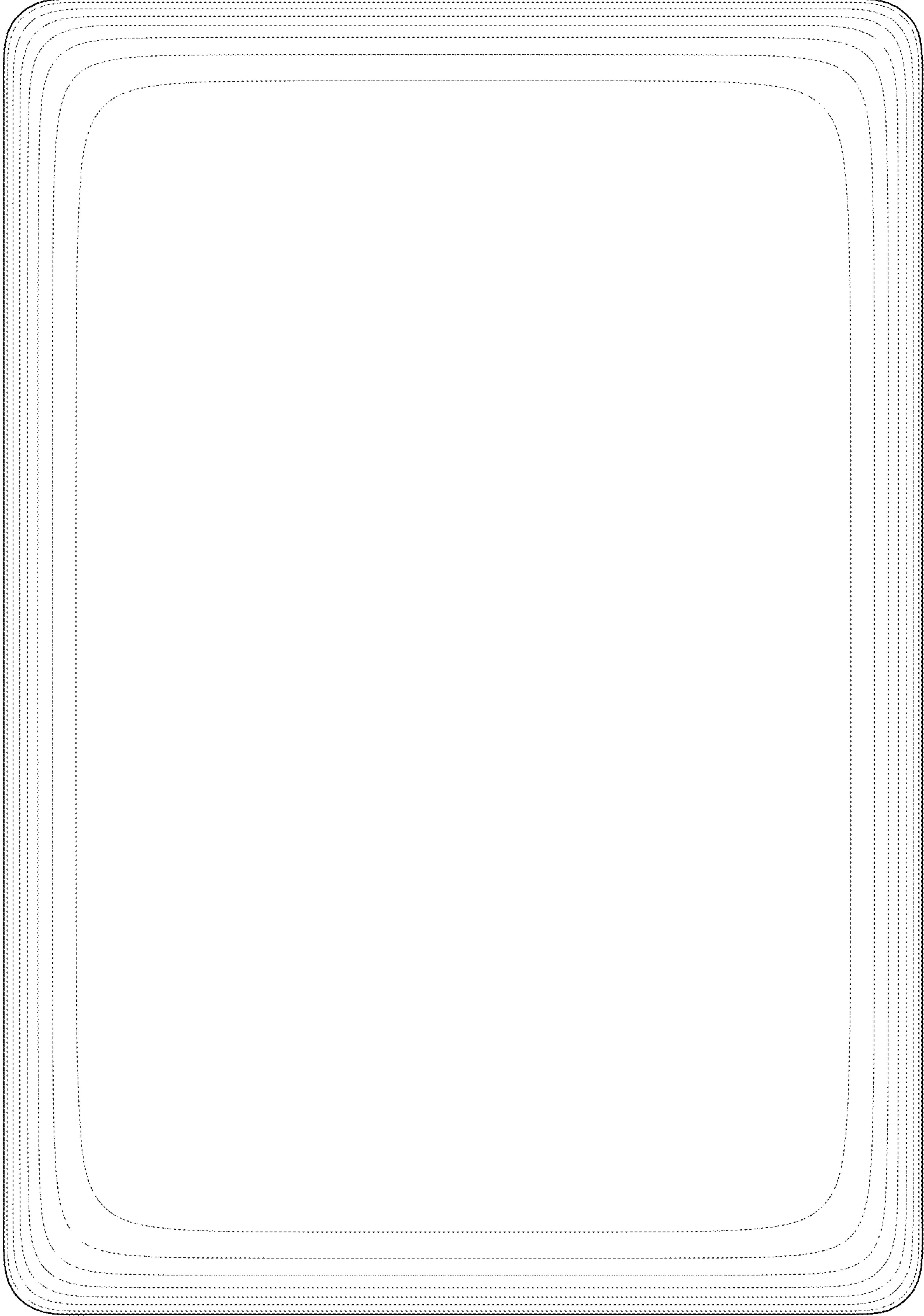

Fig. 7

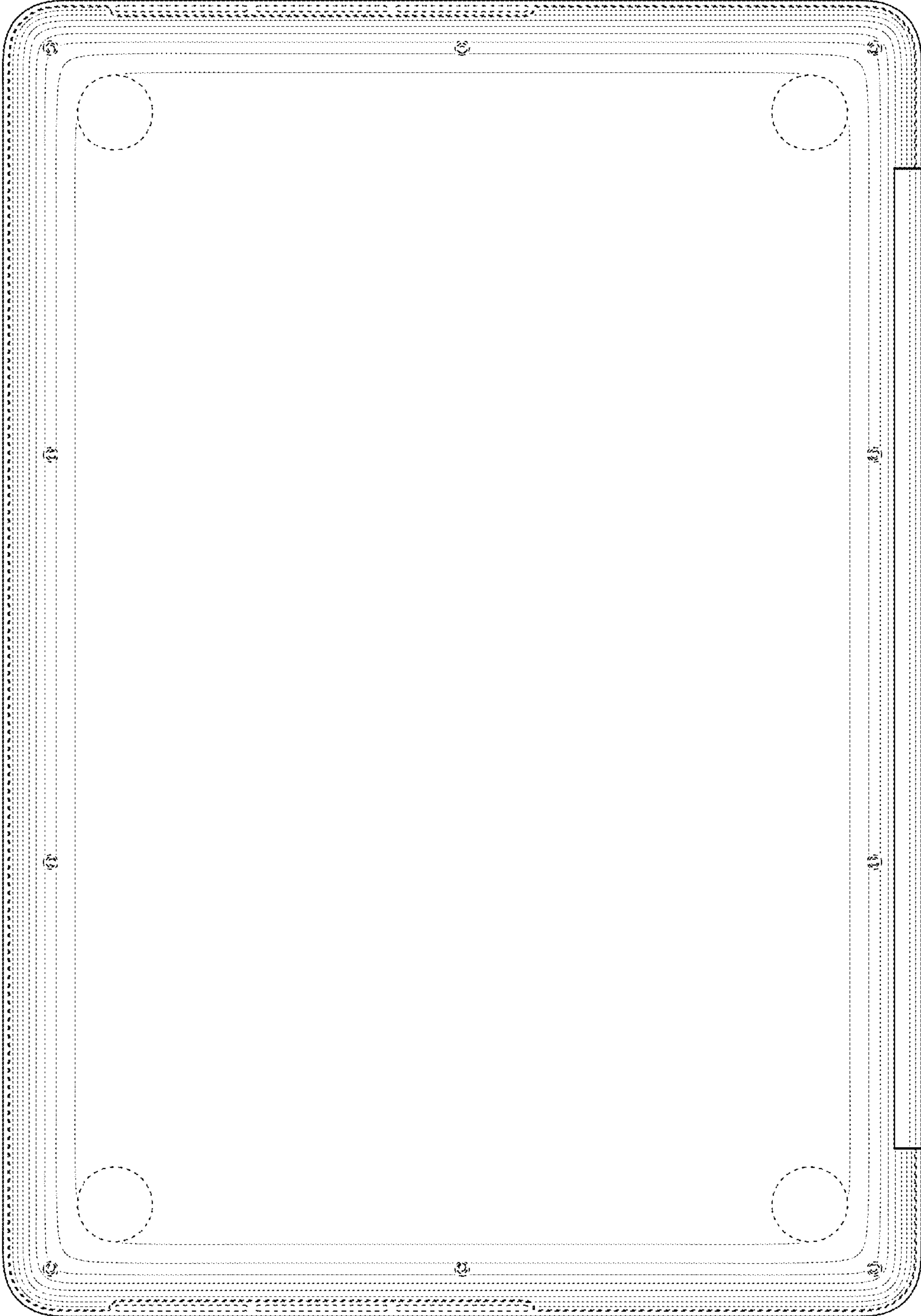

Fig. 8

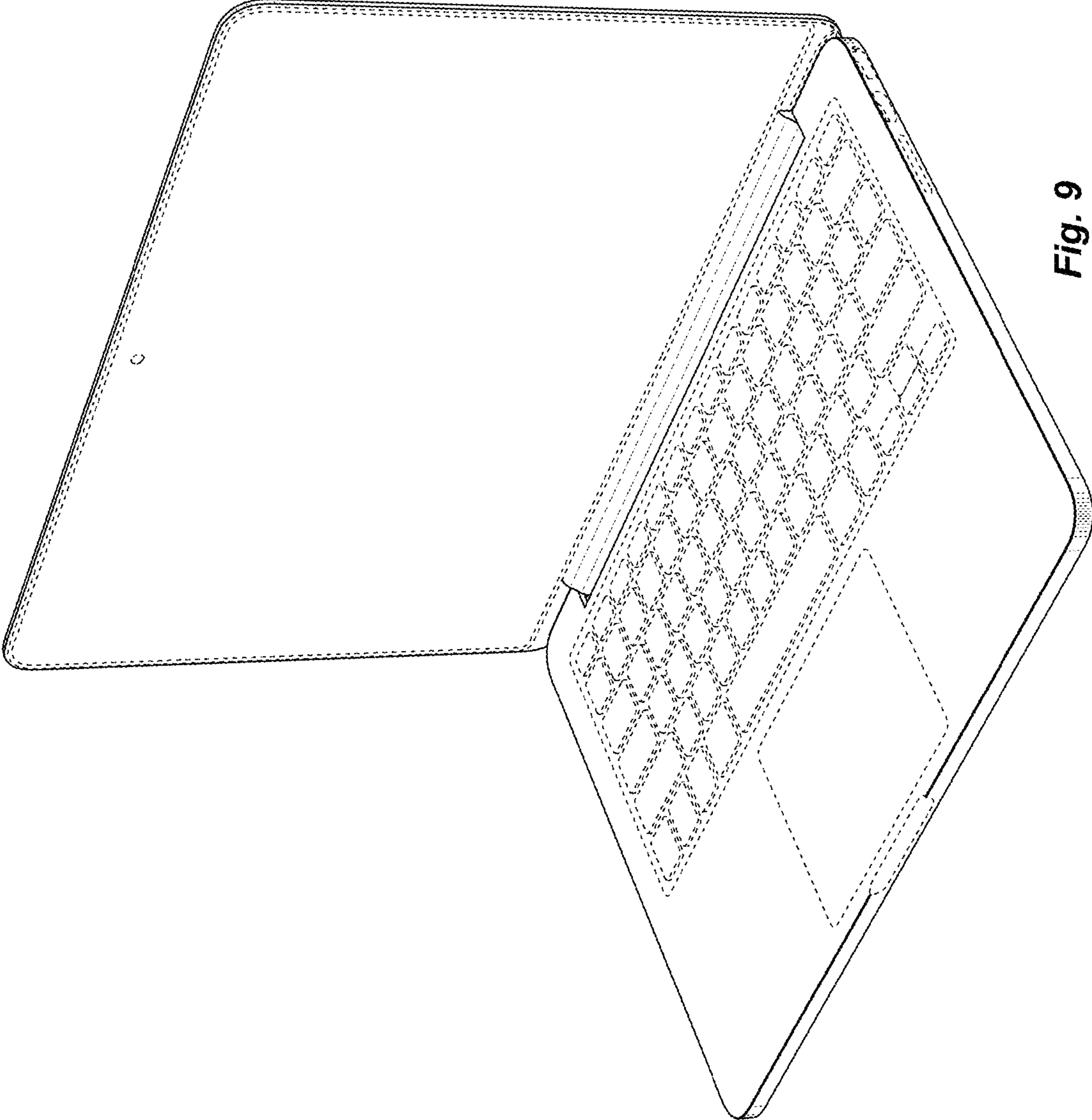

Fig. 9

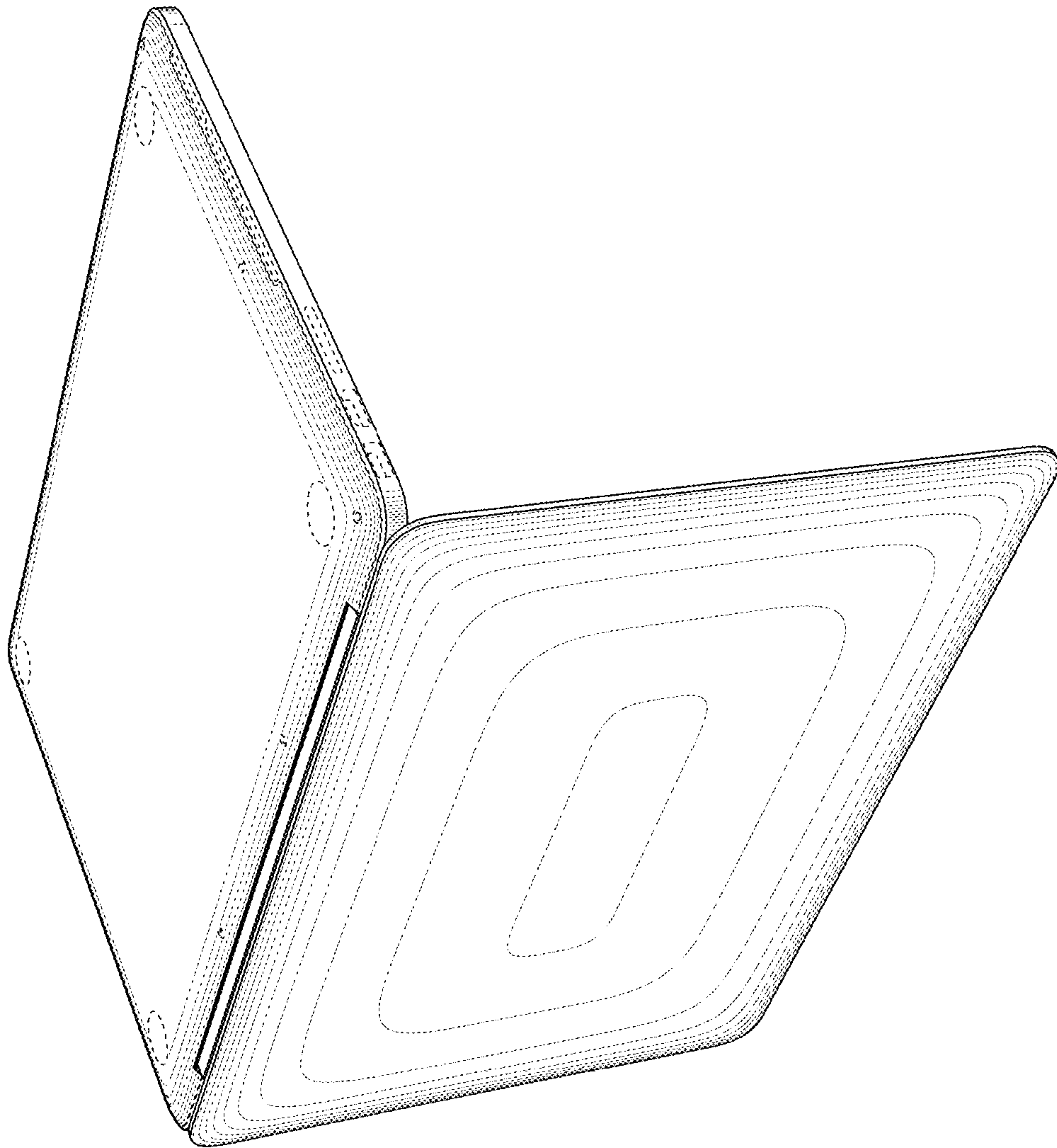

Fig. 10

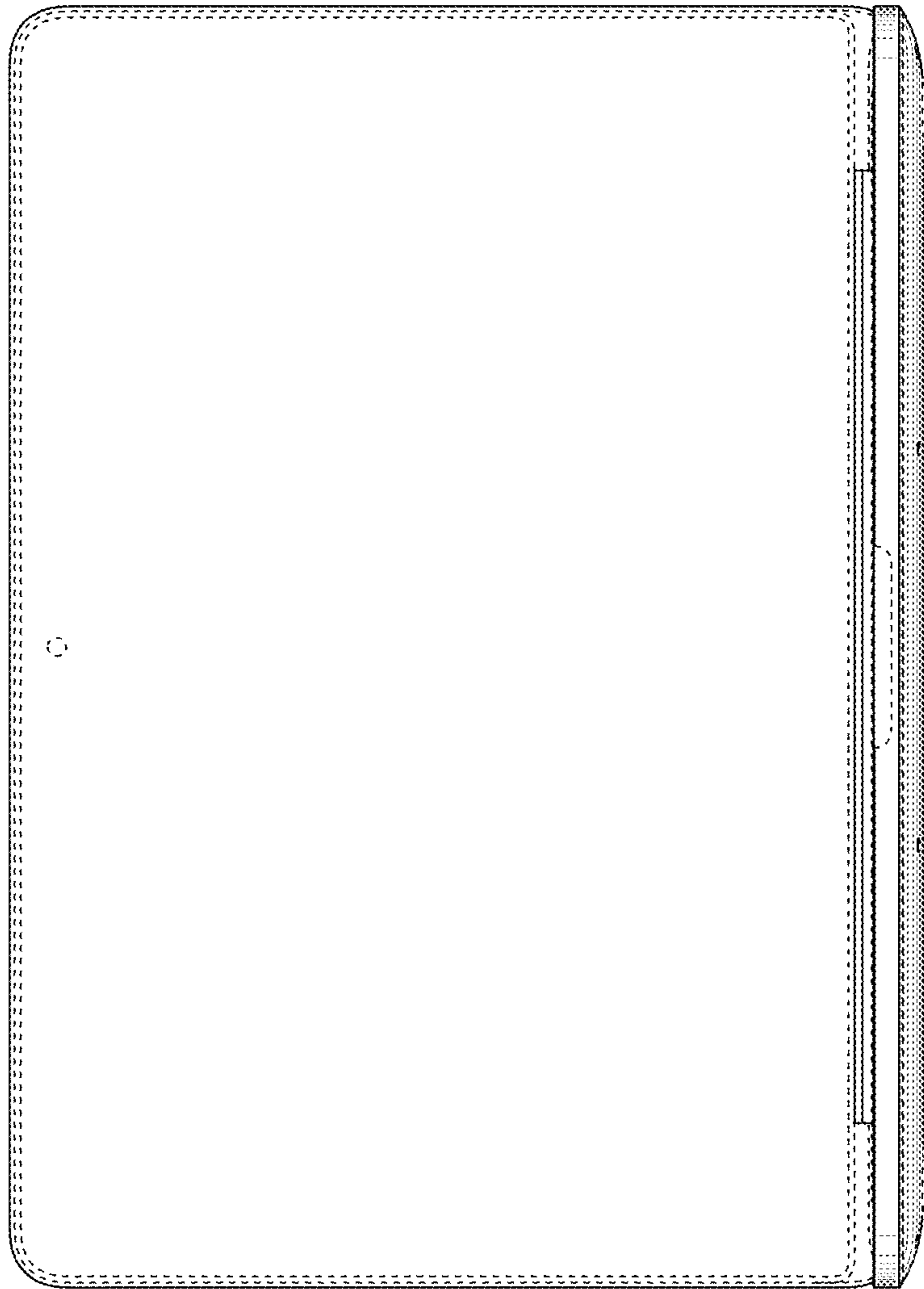

Fig. 11

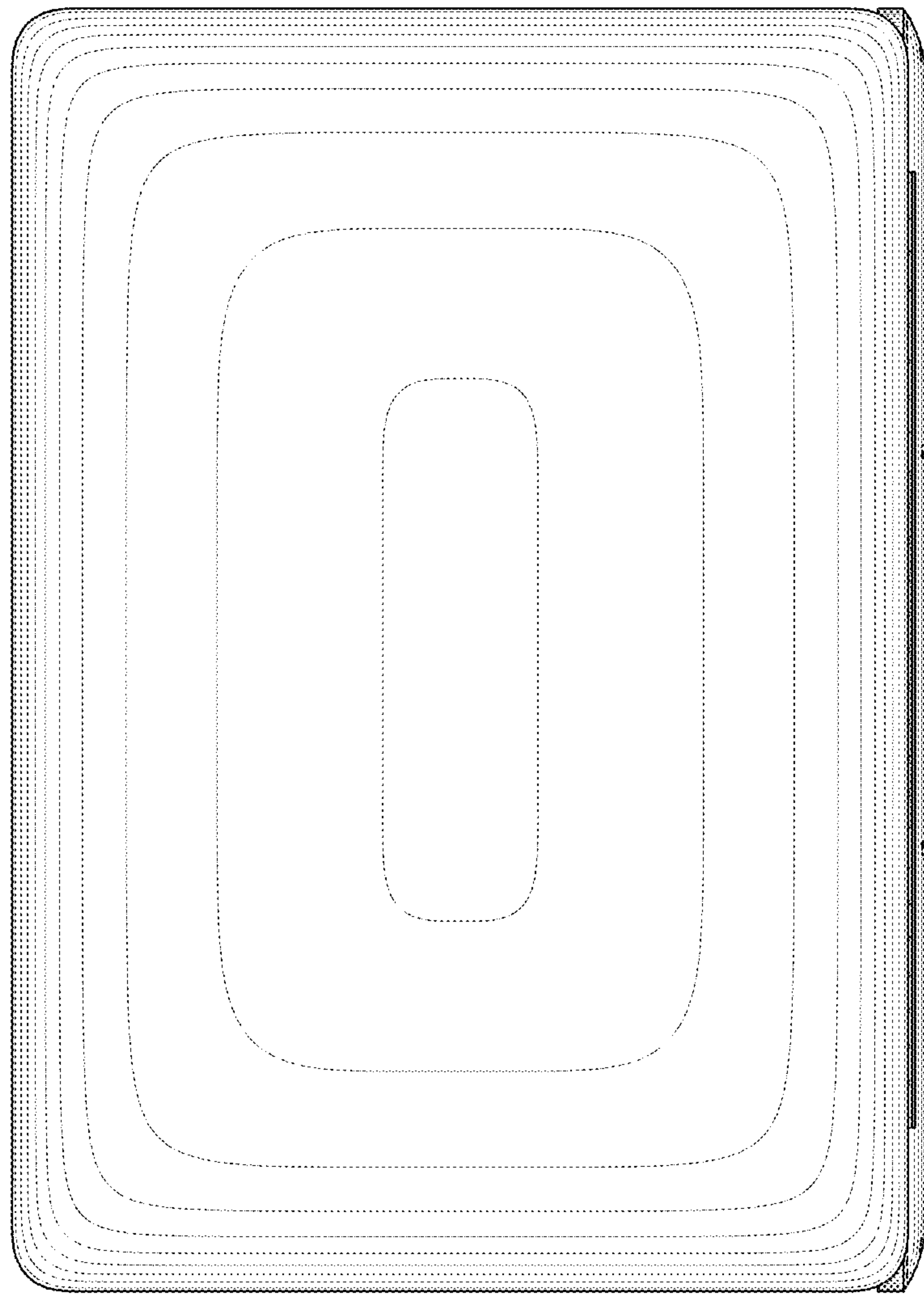

Fig. 12

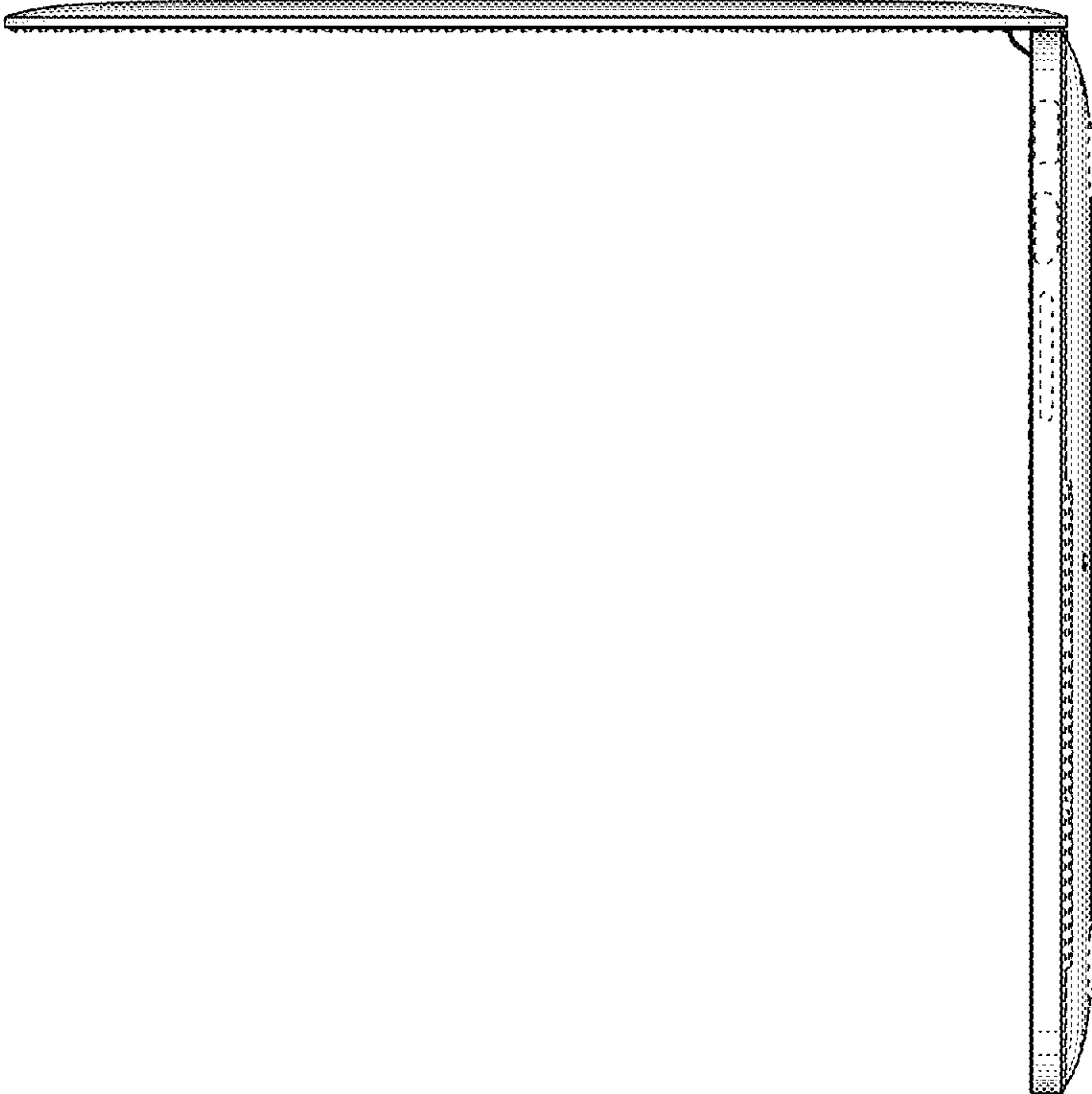

Fig. 14

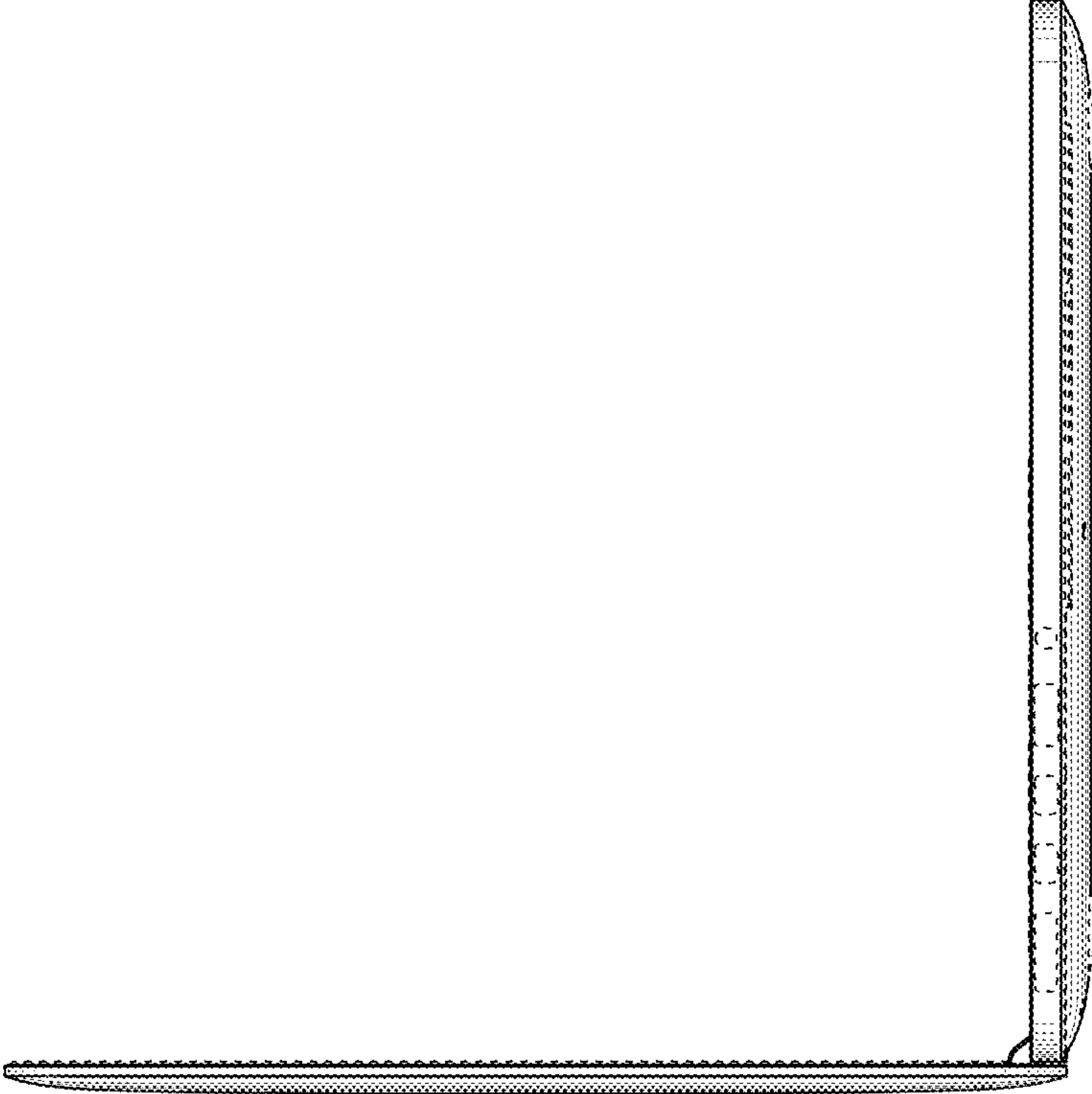

Fig. 13

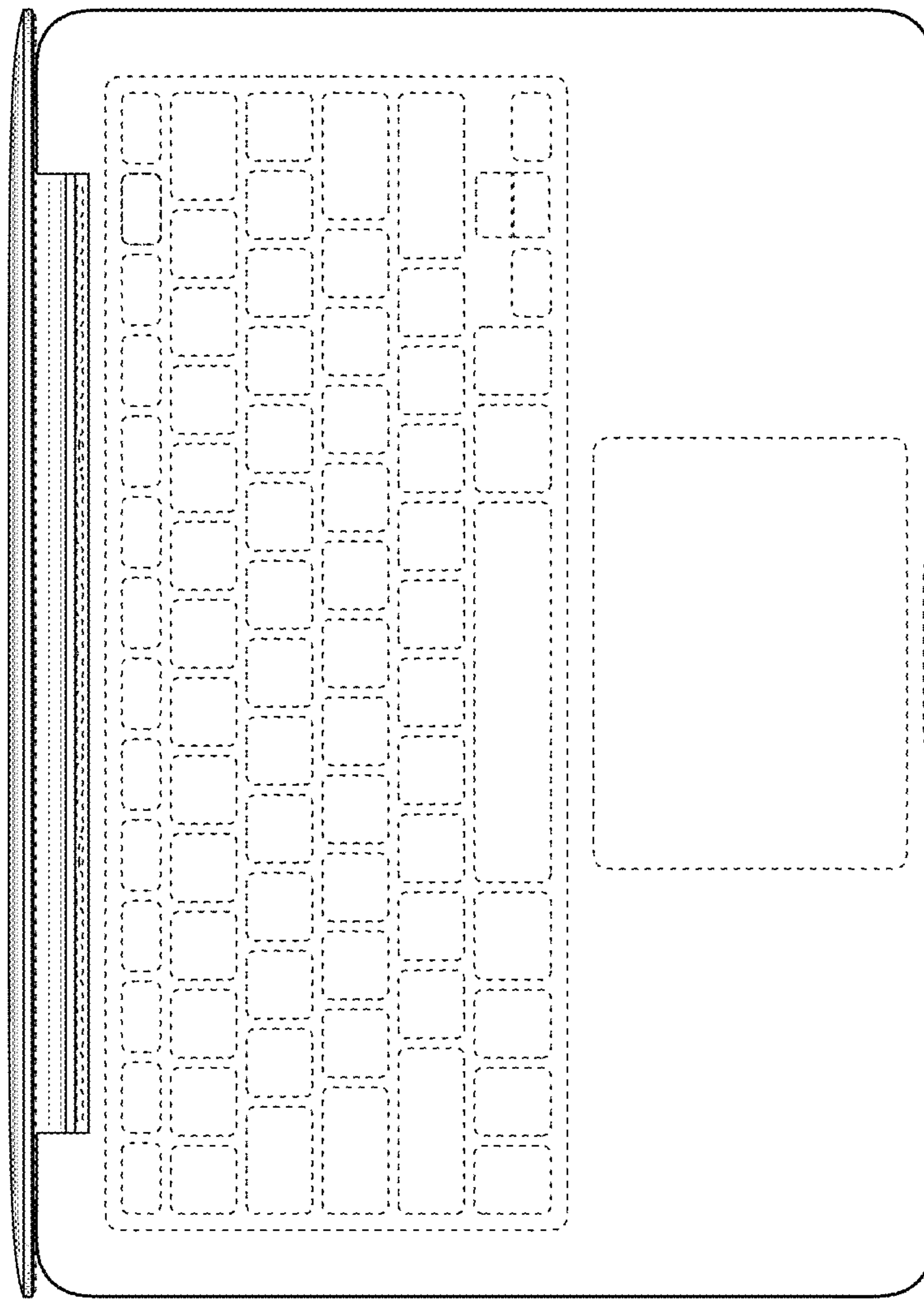

Fig. 15

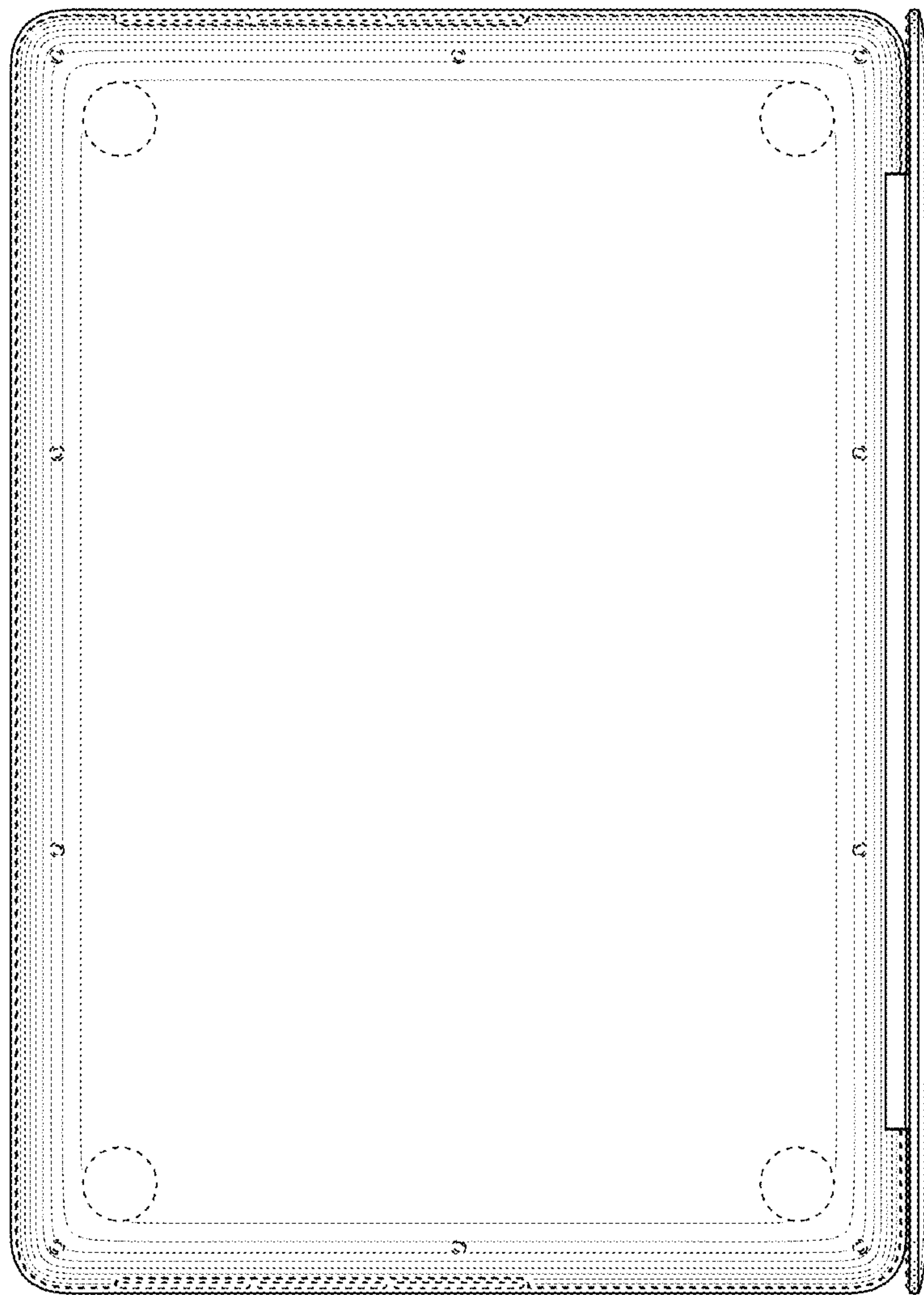

Fig. 16

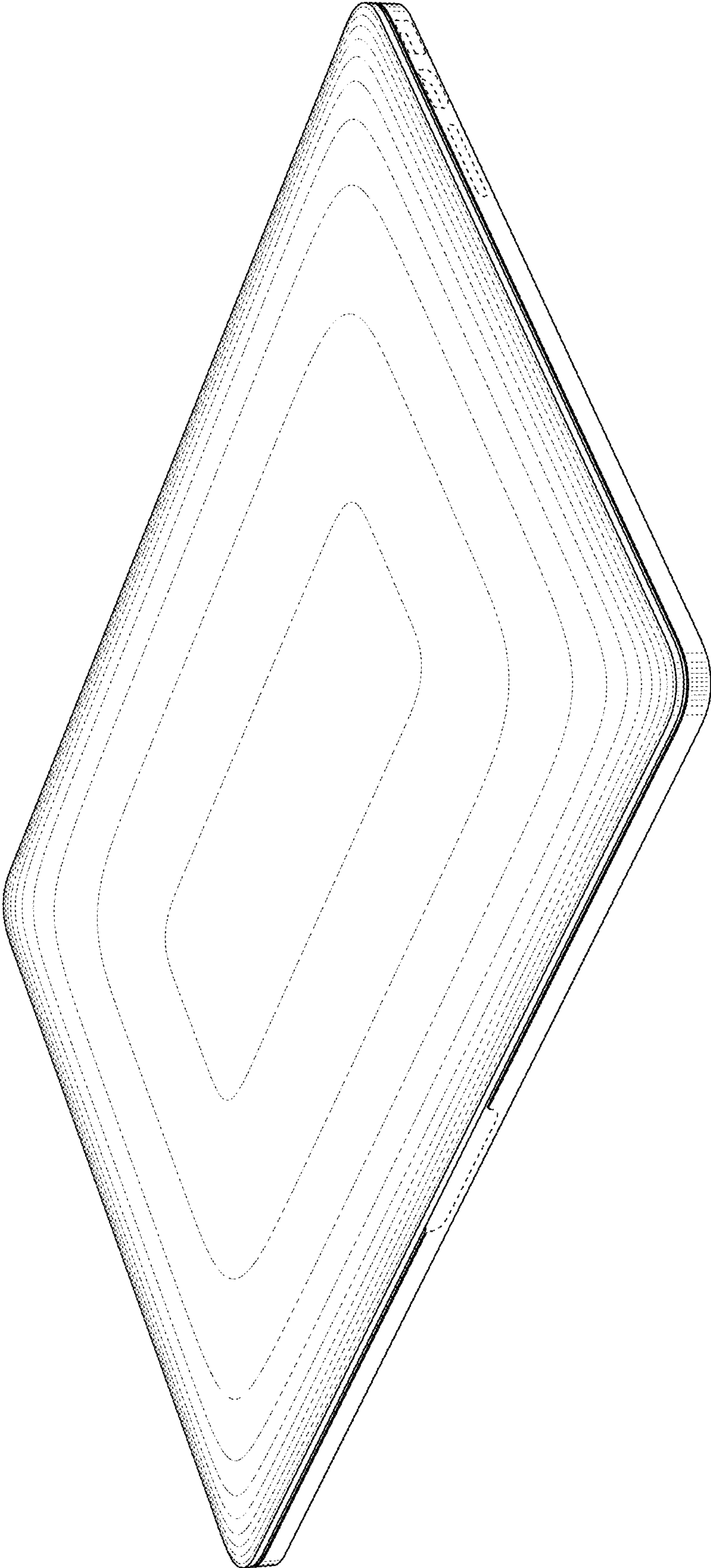

Fig. 17

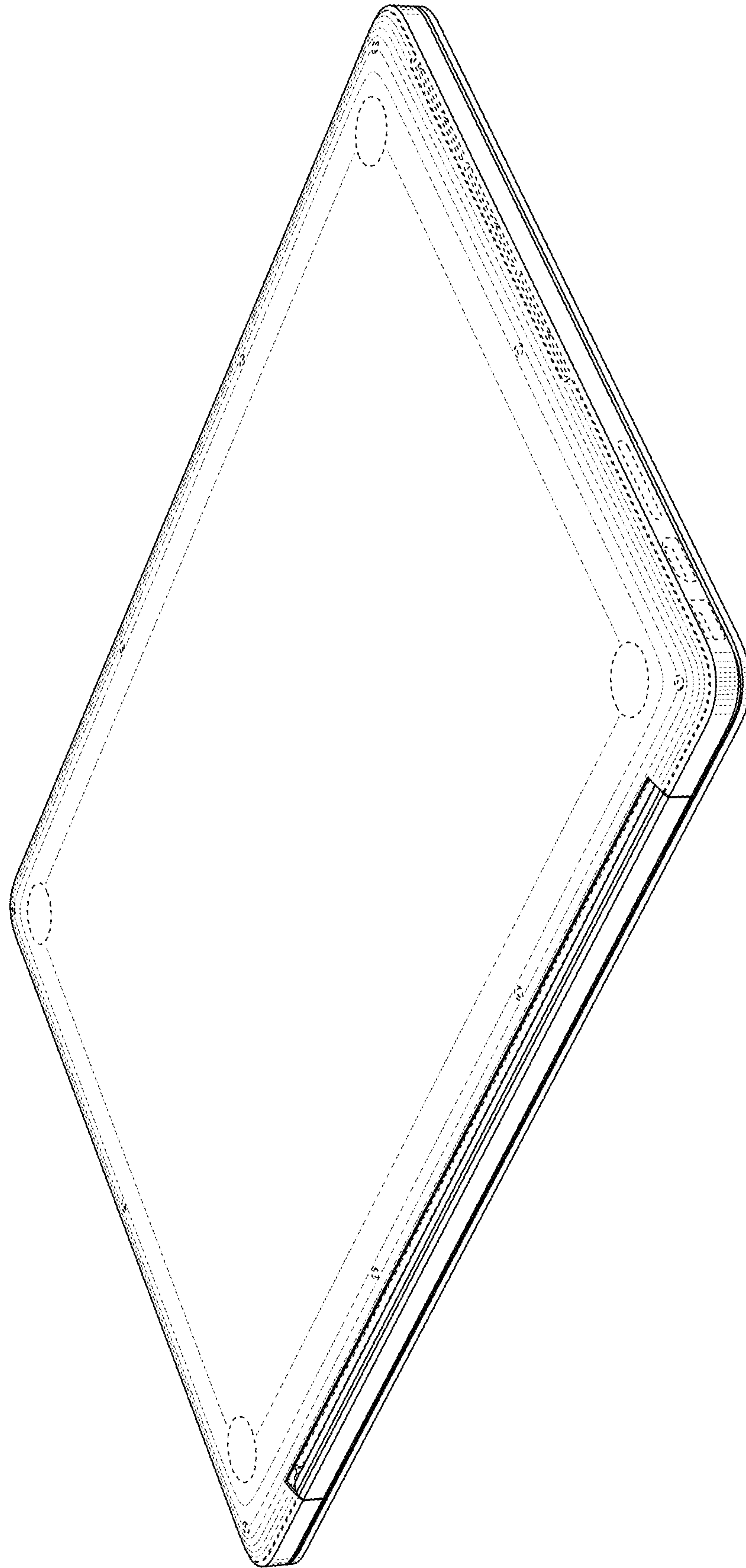

Fig. 18

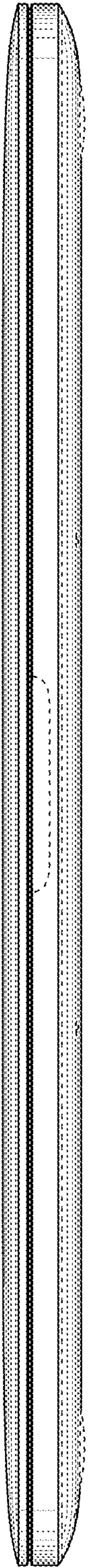

Fig. 19

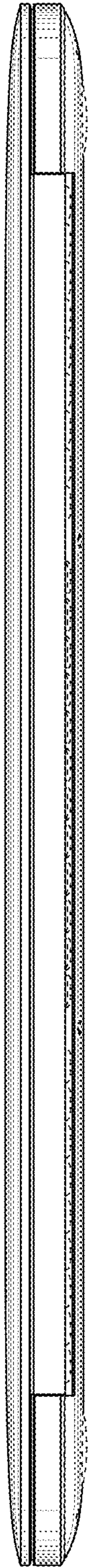

Fig. 20

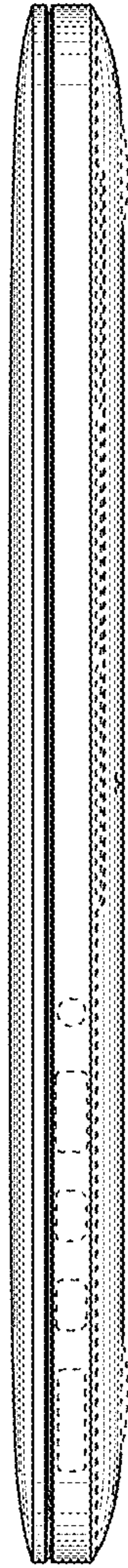

Fig. 21

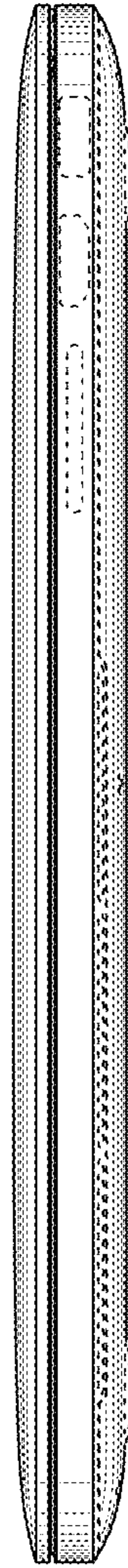

Fig. 22

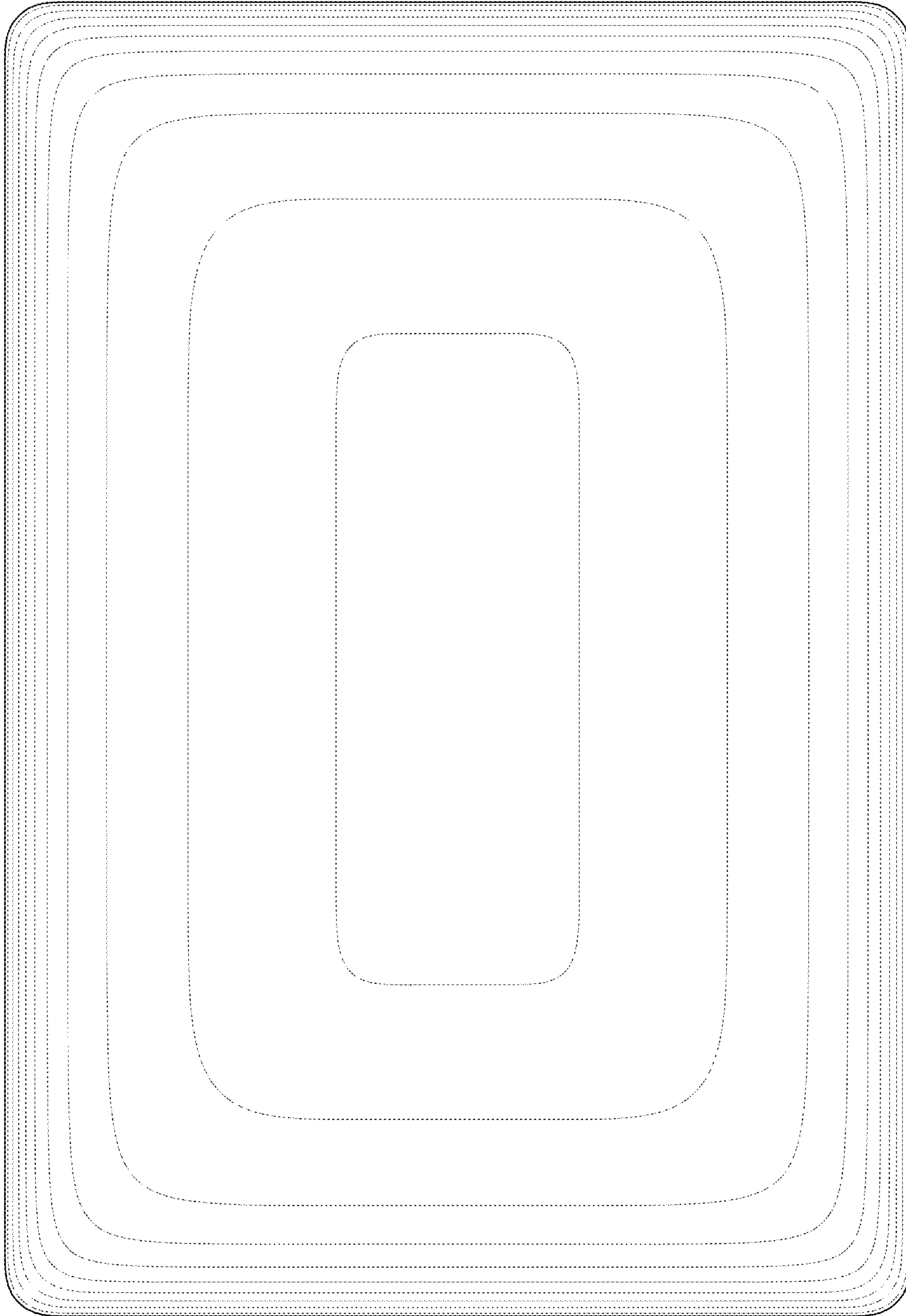

Fig. 23

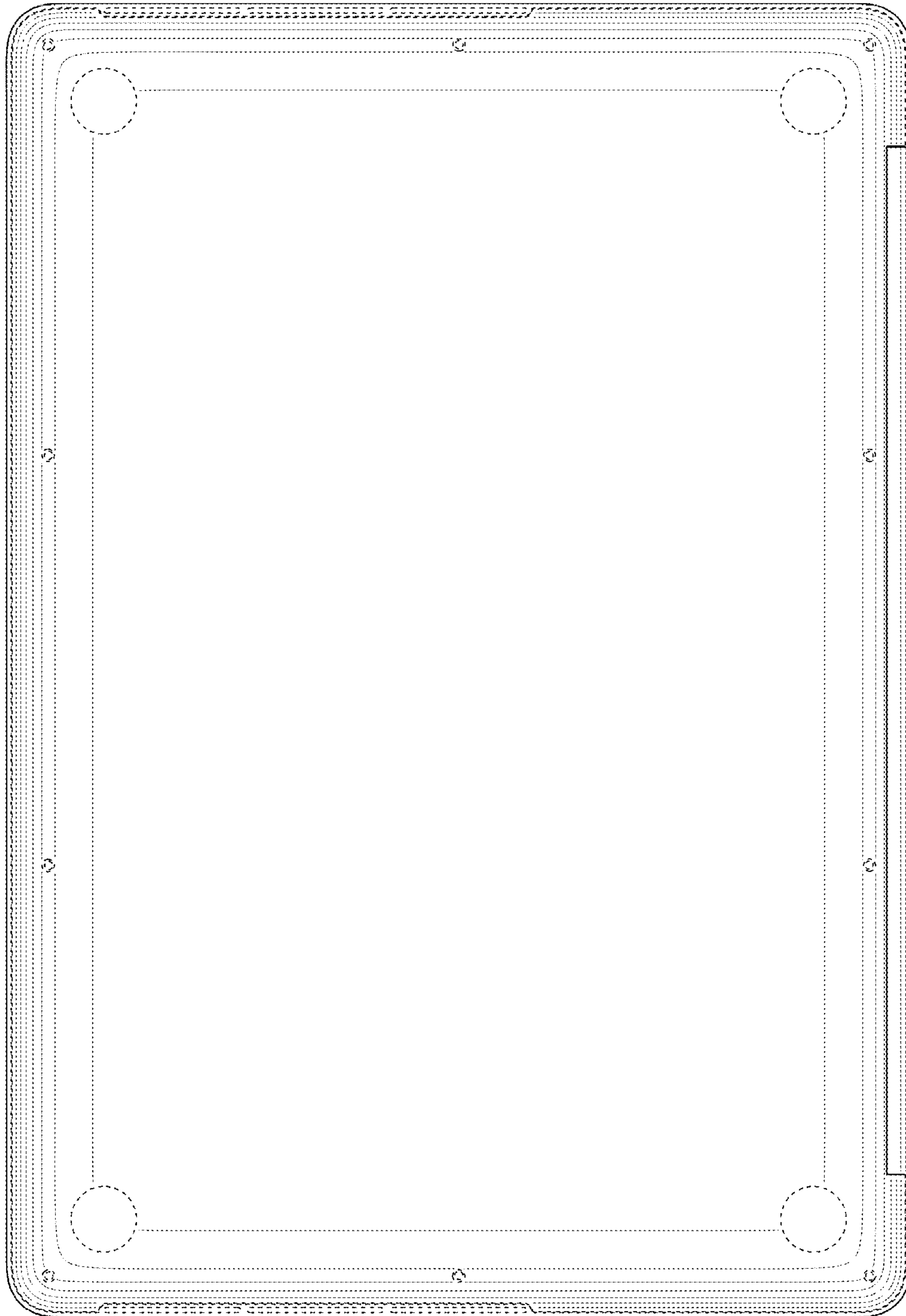

Fig. 24

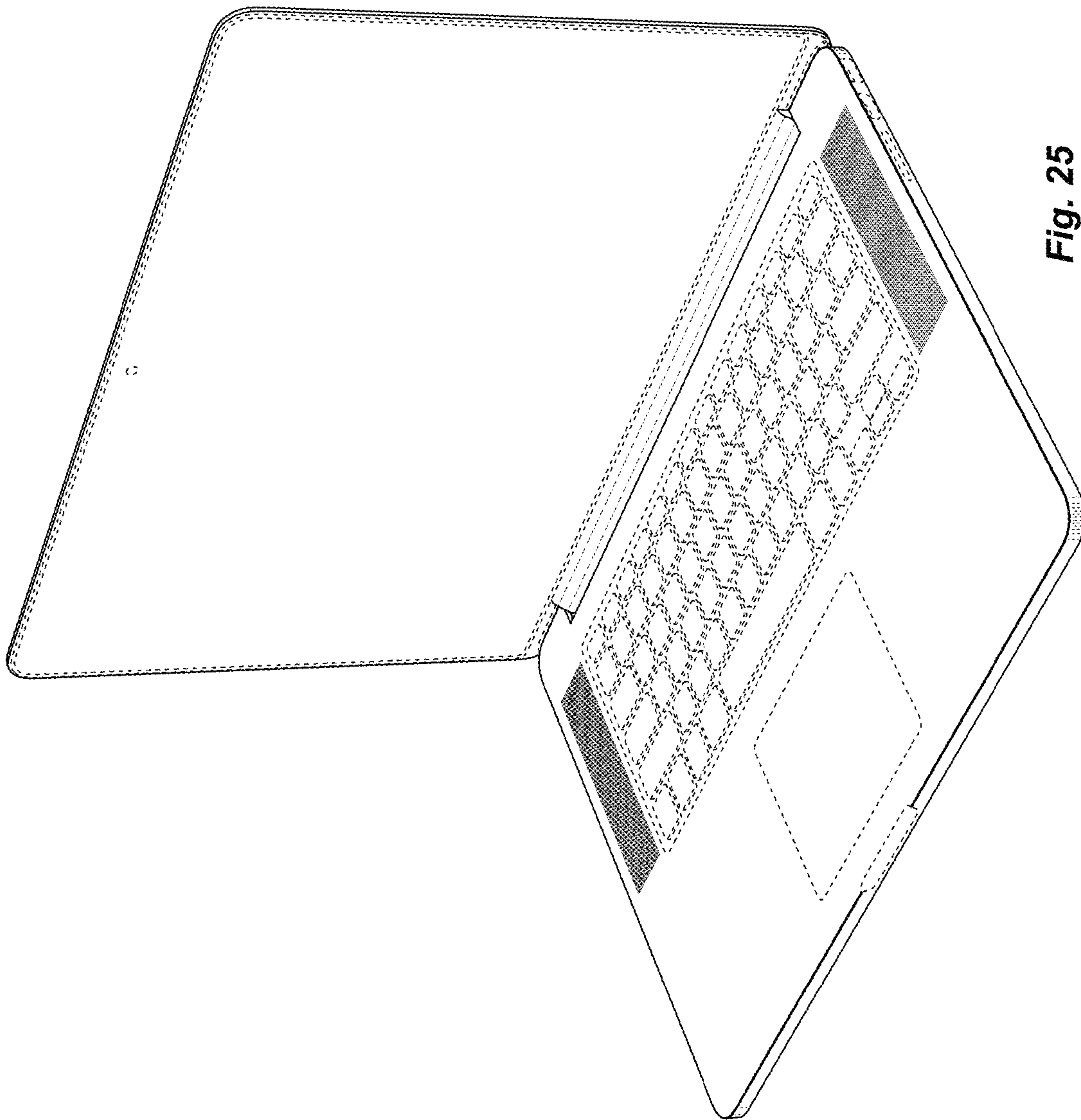

Fig. 25

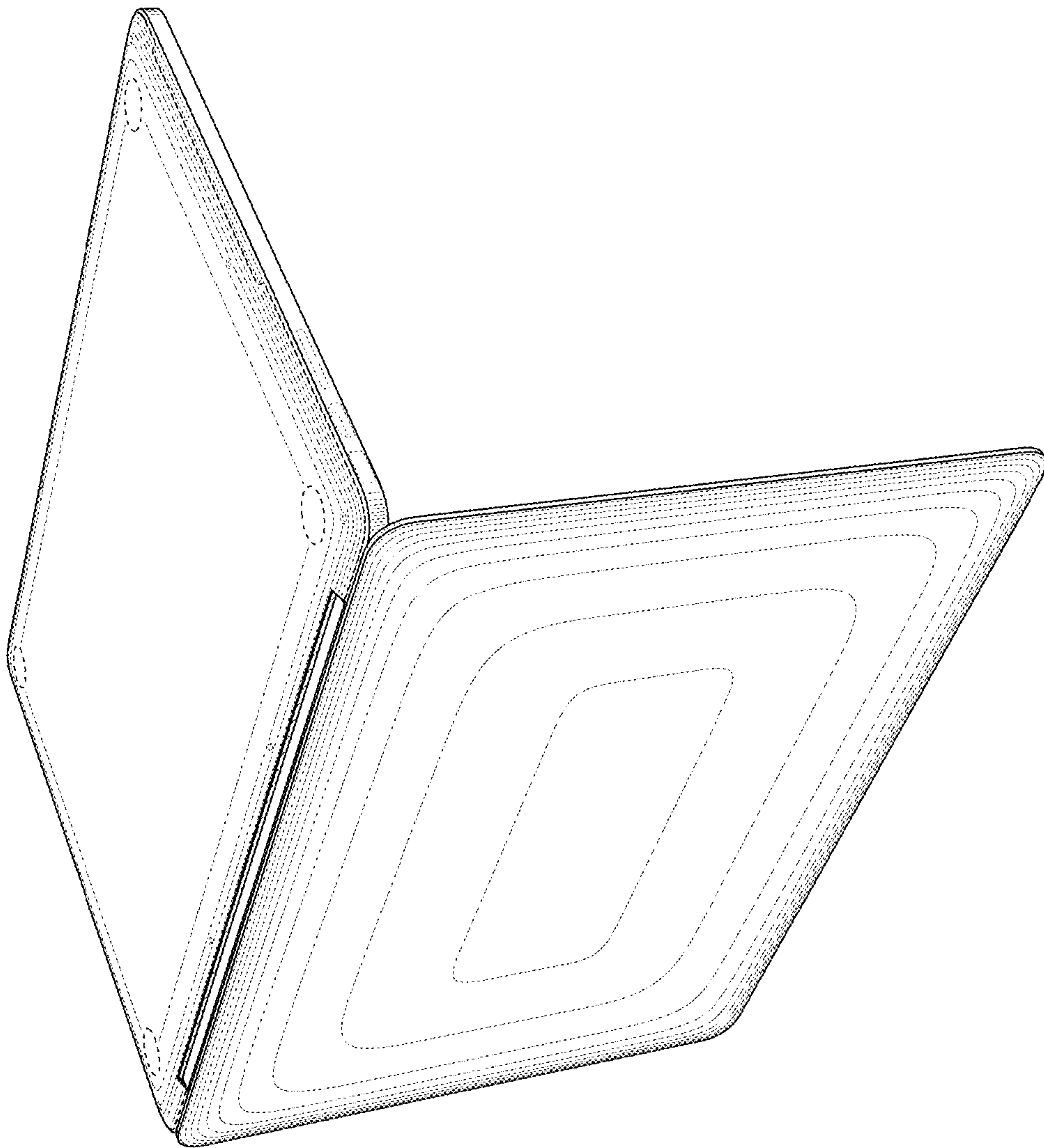

Fig. 26

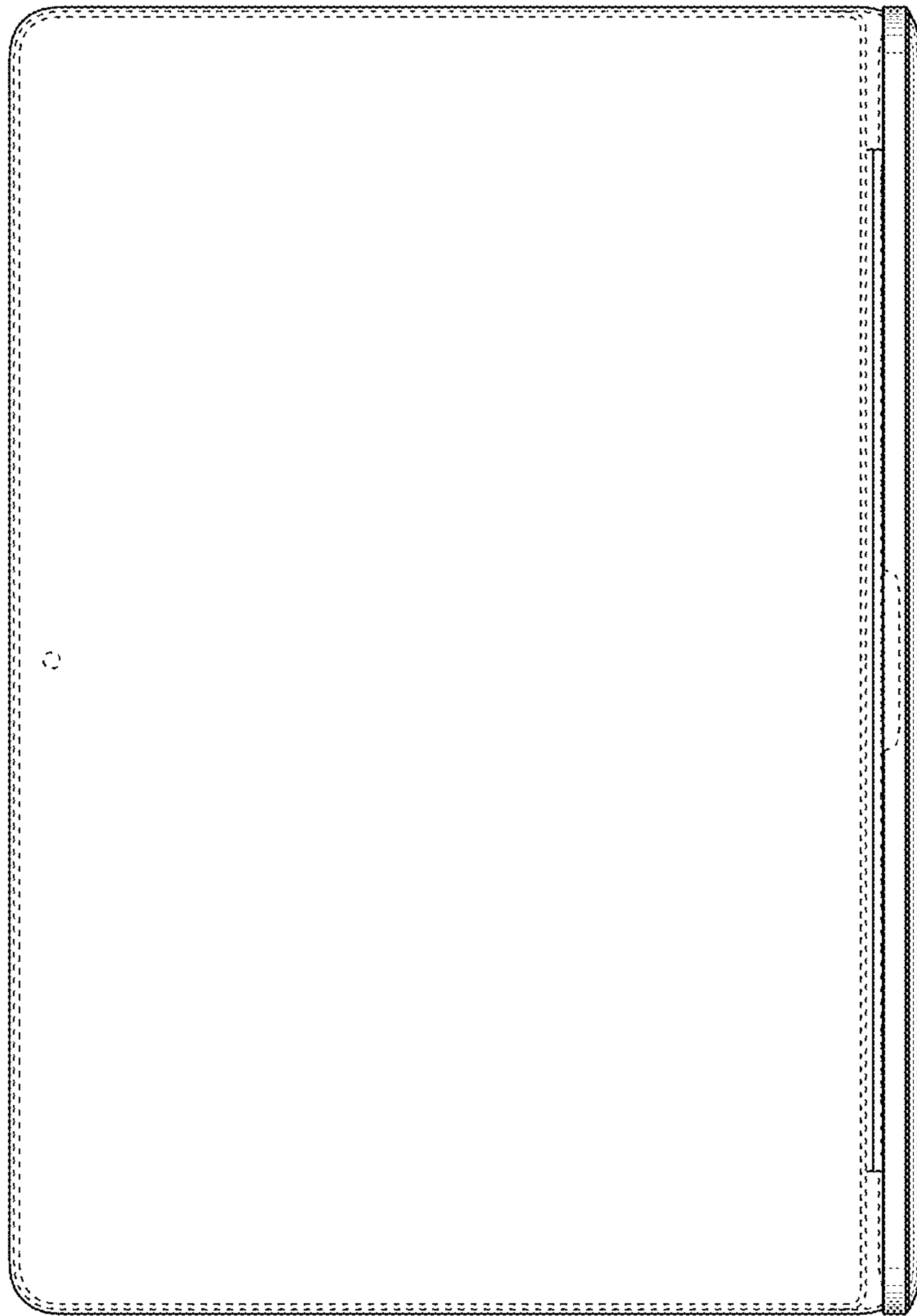

Fig. 27

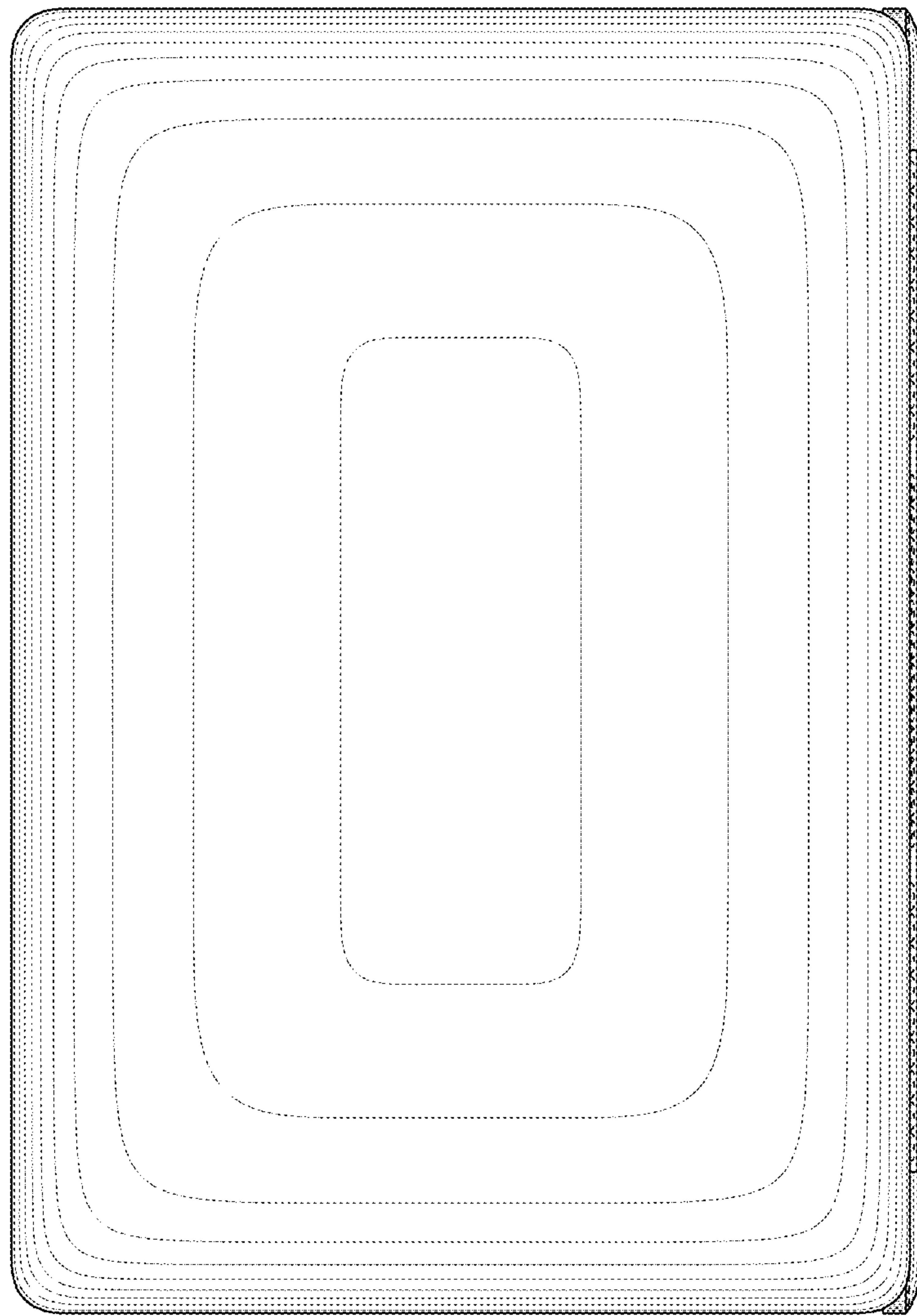

Fig. 28

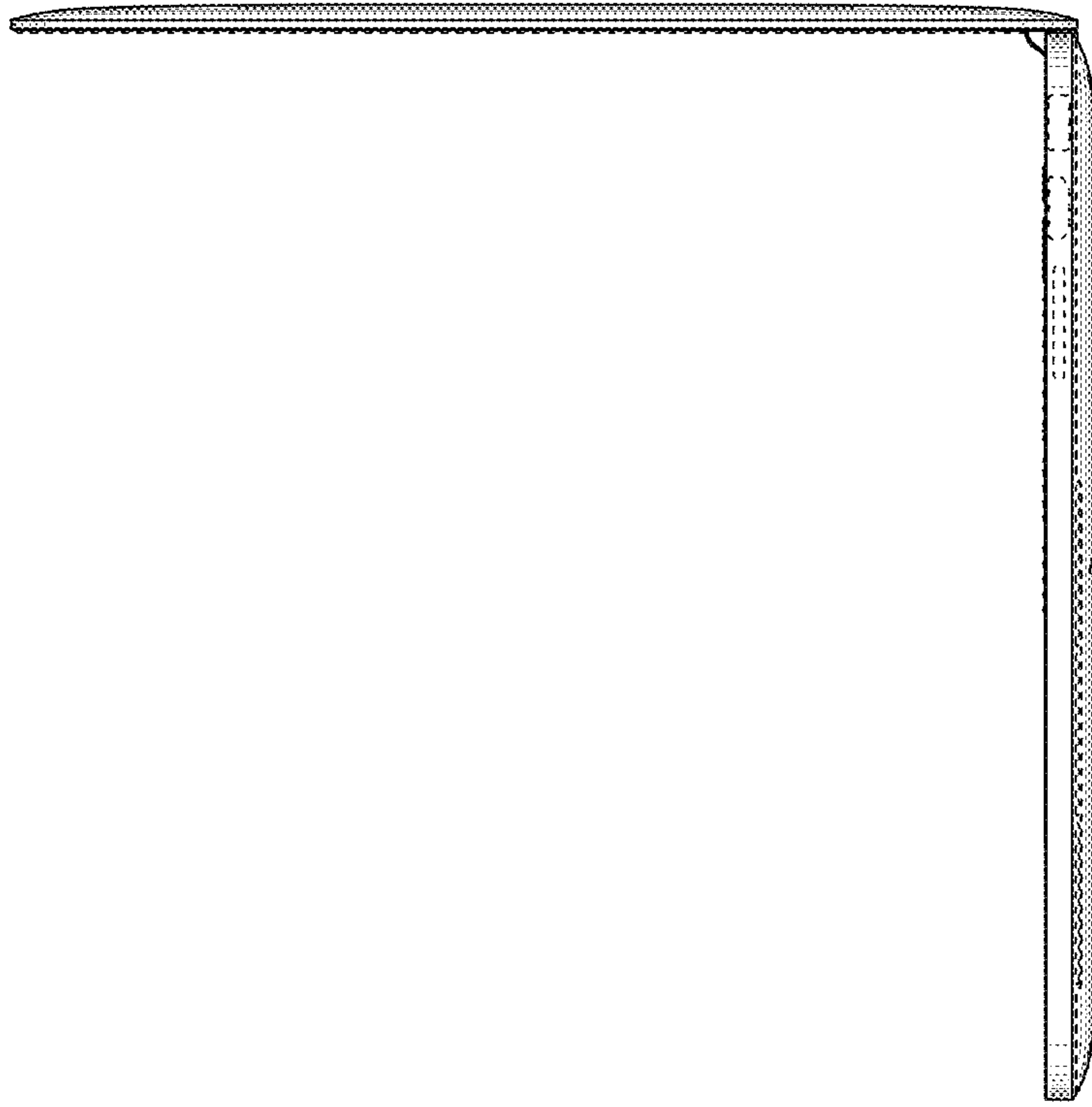

Fig. 30

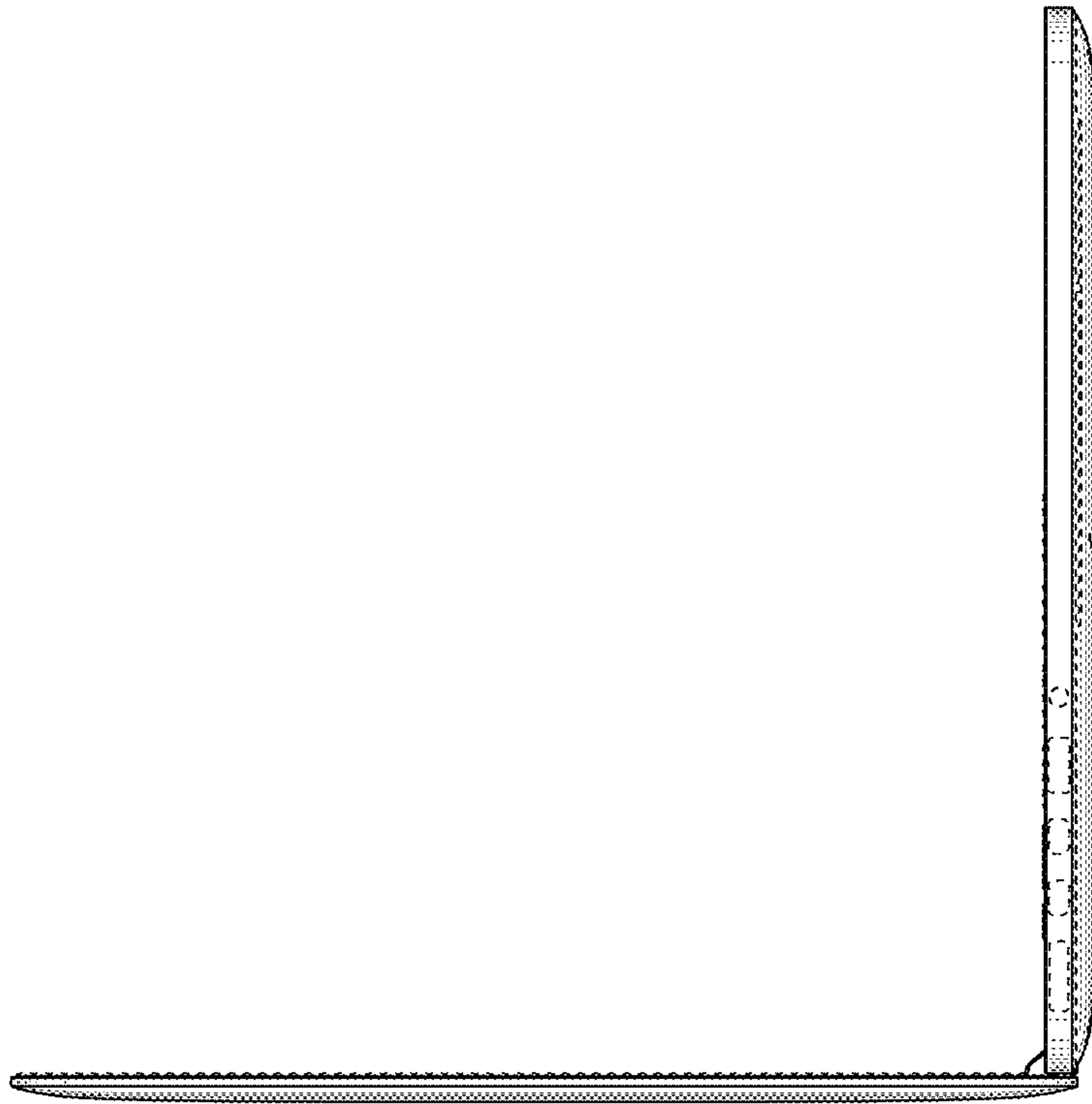

Fig. 29

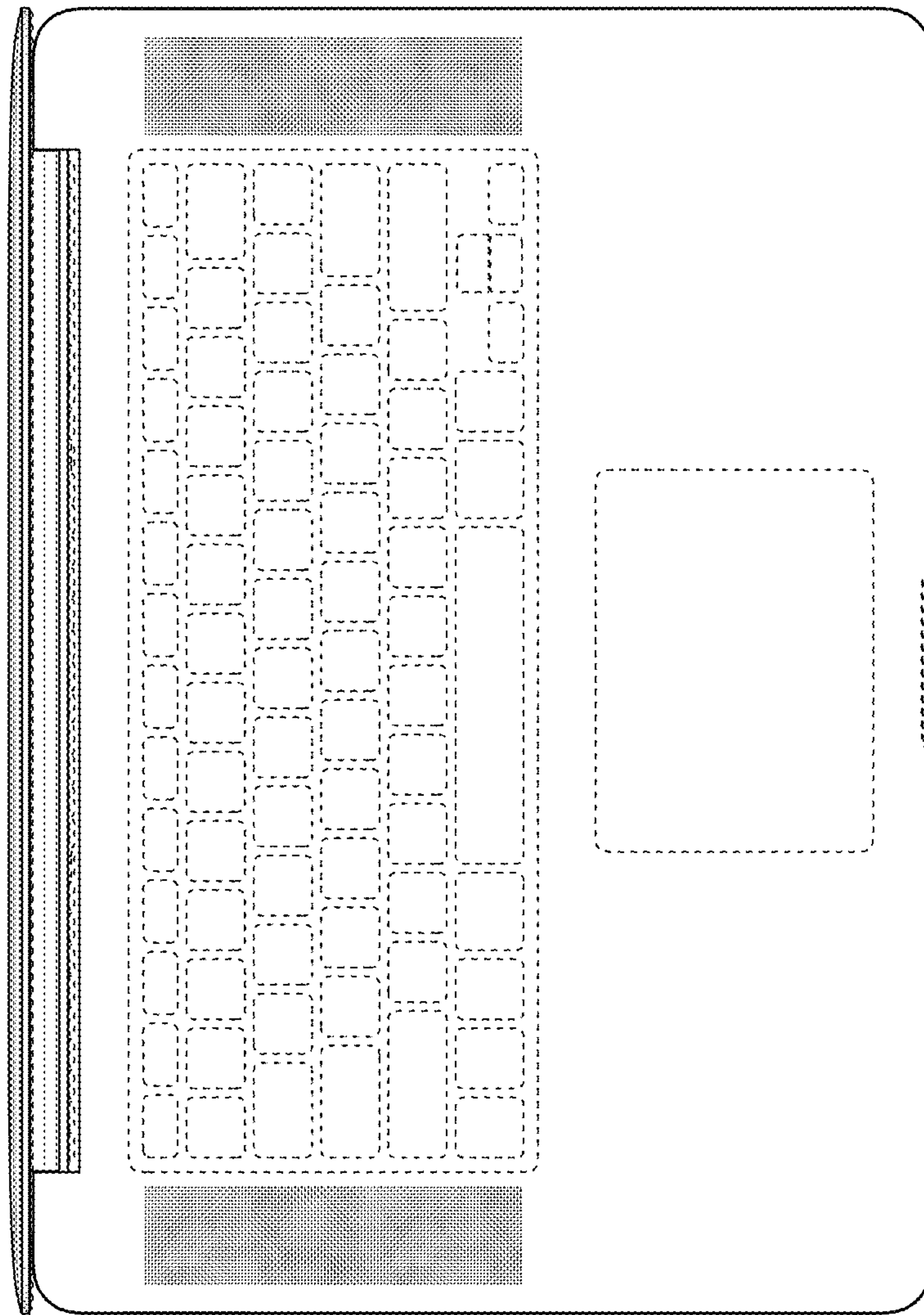

Fig. 31

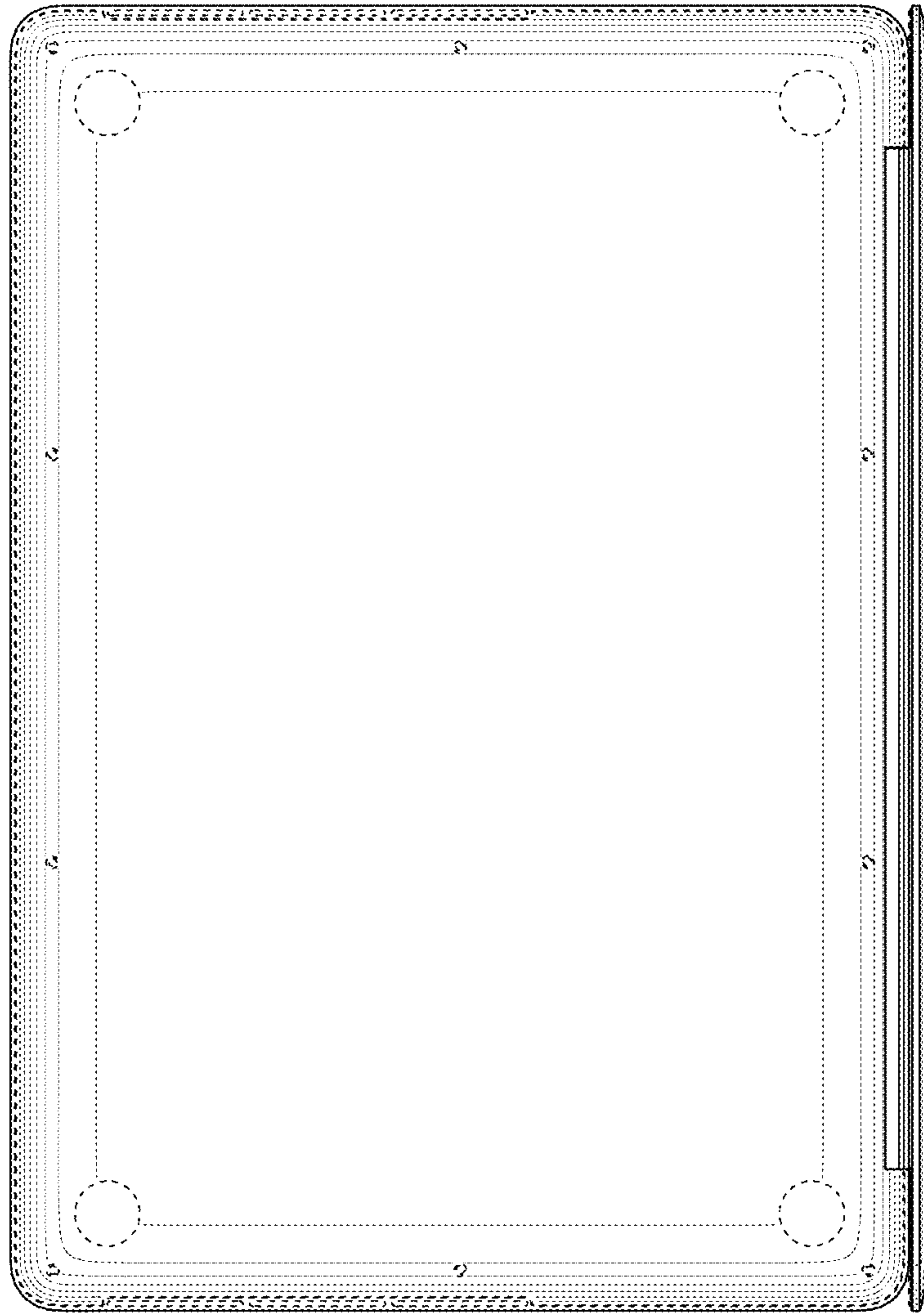

Fig. 32