



US00D775598S

(12) **United States Design Patent**  
**Kim et al.**

(10) **Patent No.:** **US D775,598 S**  
(45) **Date of Patent:** **\*\* Jan. 3, 2017**

(54) **ELECTRONIC DEVICE**

- (71) Applicant: **Samsung Electronics Co., Ltd.**, Suwon-si (KR)
- (72) Inventors: **Nam-Su Kim**, Seoul (KR); **Do-Hyung Ha**, Gwangmyeong-si (KR); **Sae-Hee Lee**, Incheon (KR); **Hyun-Sook Kim**, Seoul (KR)
- (73) Assignee: **Samsung Electronics Co., Ltd.**, Suwon-si (KR)

(\*\*) Term: **14 Years**

(21) Appl. No.: **29/503,983**

(22) Filed: **Oct. 1, 2014**

(51) **LOC (10) Cl.** ..... **14-03**

(52) **U.S. Cl.**

USPC ..... **D14/138 AB; D14/345**

(58) **Field of Classification Search**

USPC ..... D10/65; D14/138 AA, 138 AB, 138 AD, D14/138 G, 138 R, 341, 345, 203.7, 248, D14/496, 344; 361/679.27

CPC .... G06F 1/1652; G06F 1/1616; G06F 1/1618; G06F 1/1624; H04M 1/0222; H04M 1/0254; H04M 1/0256

See application file for complete search history.

(56) **References Cited**

**U.S. PATENT DOCUMENTS**

D435,550 S	*	12/2000	Chu	.....	D14/345
D588,126 S	*	3/2009	Chiang	.....	D14/345
D626,124 S	*	10/2010	Chyan	.....	D14/341
D649,966 S	*	12/2011	Chiu	.....	D14/341
8,730,667 B2	*	5/2014	Kaneko	.....	A45C 11/00 206/320
D706,301 S	*	6/2014	Akana	.....	D14/341
D716,253 S	*	10/2014	Lee	.....	D14/138 AB
D716,751 S	*	11/2014	Lee	.....	D14/138 AB
D719,540 S	*	12/2014	Lee	.....	D14/138 AB
D719,541 S	*	12/2014	Lee	.....	D14/138 AB

(Continued)

**OTHER PUBLICATIONS**

Samsung, Flexible OLED Display Phone, as posted at PhoneArena [online], posting date not available [site visited Jul. 28, 2016] Available from the Internet, <URL: [http://www.phonearena.com/news/Samsung-and-LG-both-racing-to-out-a-foldable-phone\\_id74741](http://www.phonearena.com/news/Samsung-and-LG-both-racing-to-out-a-foldable-phone_id74741)>.\*

(Continued)

*Primary Examiner* — Jeffrey D Asch

*Assistant Examiner* — Rebekah A Caruso

(74) *Attorney, Agent, or Firm* — NSIP Law

(57) **CLAIM**

We claim the ornamental design for an electronic device, as shown and described.

**DESCRIPTION**

FIG. 1 is a front perspective view of an electronic device, showing our new design;  
 FIG. 2 is a front view thereof;  
 FIG. 3 is a rear view thereof;  
 FIG. 4 is a left-side view thereof;  
 FIG. 5 is a right-side view thereof;  
 FIG. 6 is a top view thereof;  
 FIG. 7 is a bottom view thereof;  
 FIG. 8 is another front perspective view in which the electronic device is shown in a partially open position; and, FIG. 9 is another front perspective view in which the electronic device is shown in an open position.

The broken lines shown in the figures that are immediately adjacent to the shaded areas and define unshaded regions represent the bounds of the claim. All other broken lines, including the features within broken line boundaries and the tiny circles at either side of the speaker, are directed to environment. The broken lines form no part of the claimed design.

**1 Claim, 7 Drawing Sheets**

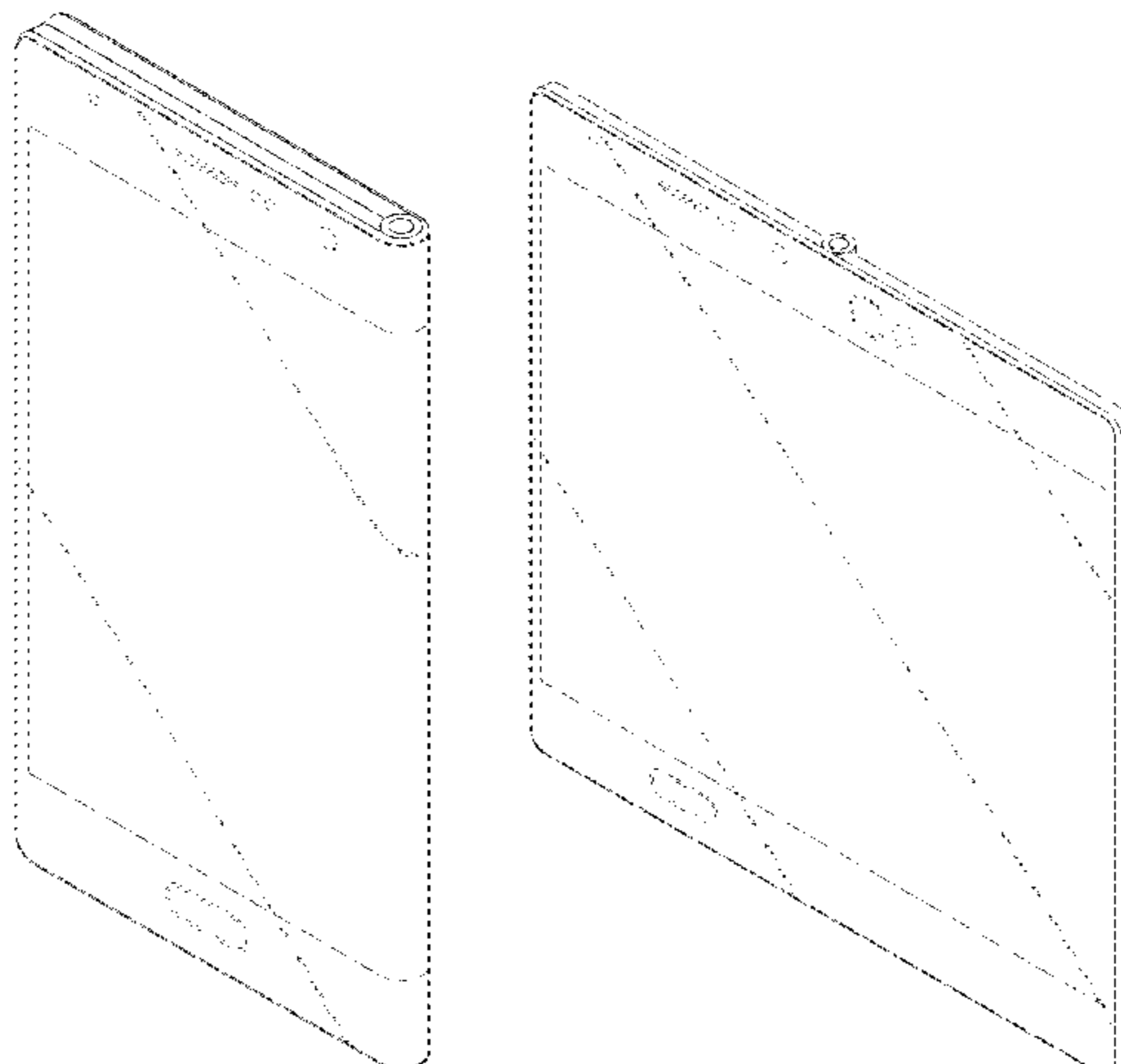

(56)

**References Cited**

U.S. PATENT DOCUMENTS

8,971,032 B2 \* 3/2015 Griffin ..... G06F 1/1616  
 345/156  
 D726,674 S \* 4/2015 Lee ..... D14/138 G  
 D742,873 S \* 11/2015 Ahn ..... D14/341  
 D744,493 S \* 12/2015 Kim ..... D14/440  
 D745,484 S \* 12/2015 Lee ..... D14/138 G  
 9,239,594 B2 \* 1/2016 Lee ..... G06F 1/1652  
 D749,055 S \* 2/2016 Lee ..... D14/204  
 D749,571 S \* 2/2016 Park ..... D14/203.4  
 D749,573 S \* 2/2016 Park ..... D14/203.4  
 D749,574 S \* 2/2016 Park ..... D14/203.4  
 D749,575 S \* 2/2016 Park ..... D14/203.4  
 D750,617 S \* 3/2016 Akana ..... D14/341  
 D754,657 S \* 4/2016 Kim ..... D14/345  
 2012/0044620 A1 \* 2/2012 Song ..... G06F 1/1616  
 361/679.01  
 2014/0226275 A1 \* 8/2014 Ko ..... G06F 1/1626  
 361/679.27

2015/0241925 A1 \* 8/2015 Seo ..... G06F 1/1652  
 361/679.27  
 2016/0062408 A1 \* 3/2016 Lee ..... G06F 1/1641  
 345/173  
 2016/0085268 A1 \* 3/2016 Aurongzeb ..... G06F 1/1652  
 345/156

OTHER PUBLICATIONS

Samsung, flexible screen OLED prototype for smartphones, as posted at The AndroidPIT [online], posted on Jan. 10, 2013 [site visited Jul. 28, 2016] Available from the Internet, <URL: <http://www.androidpit.com.br/samsung-tela-flexivel-oled-ces-2013>>.\*  
 LG, Triptych concept tablet-phone, as posted at wordlessTECH [online], posted on Feb. 12, 2011, [site visited Jul. 28, 2016]. Available from the Internet, <URL: <http://inhabitat.com/samsung-to-launch-flexible-oled-cell-phone-next-year/>>. <https://wordlesstech.com/lg-triptych-concept-tablet-phone/>>.\*

\* cited by examiner

FIG.1

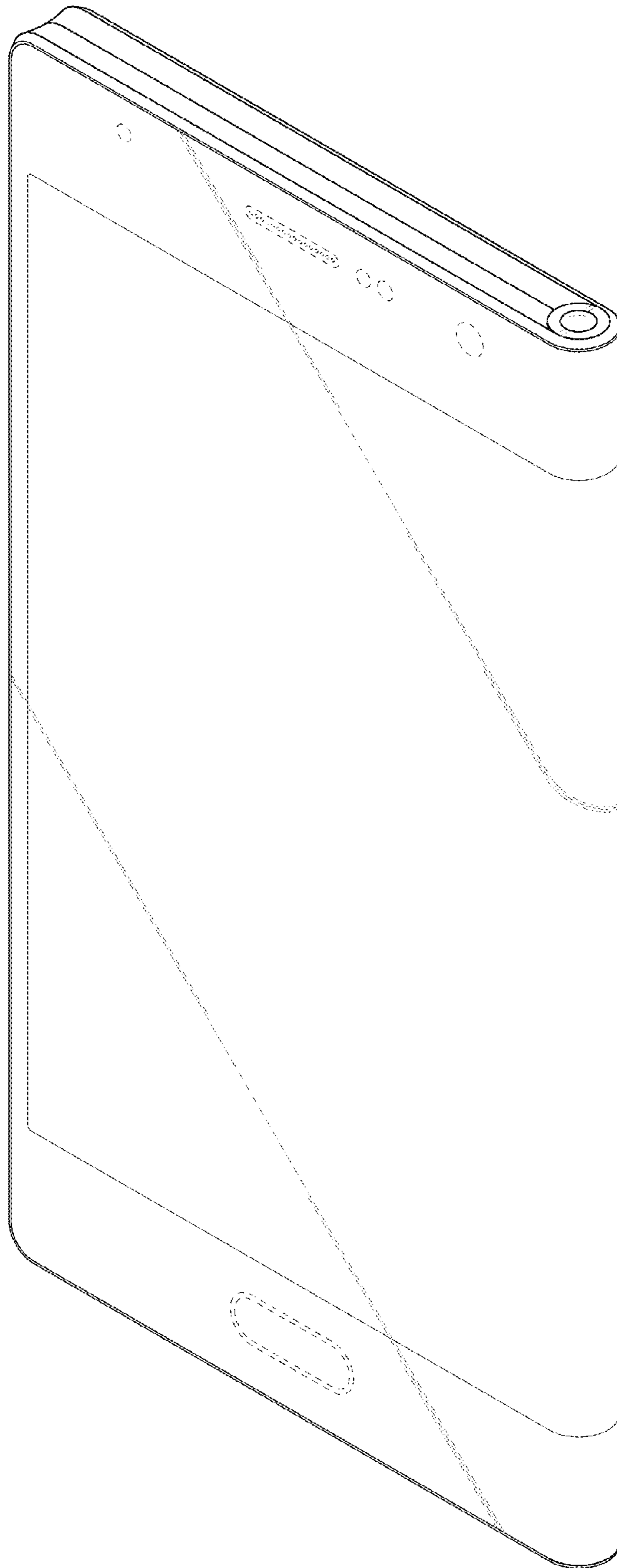

FIG.2

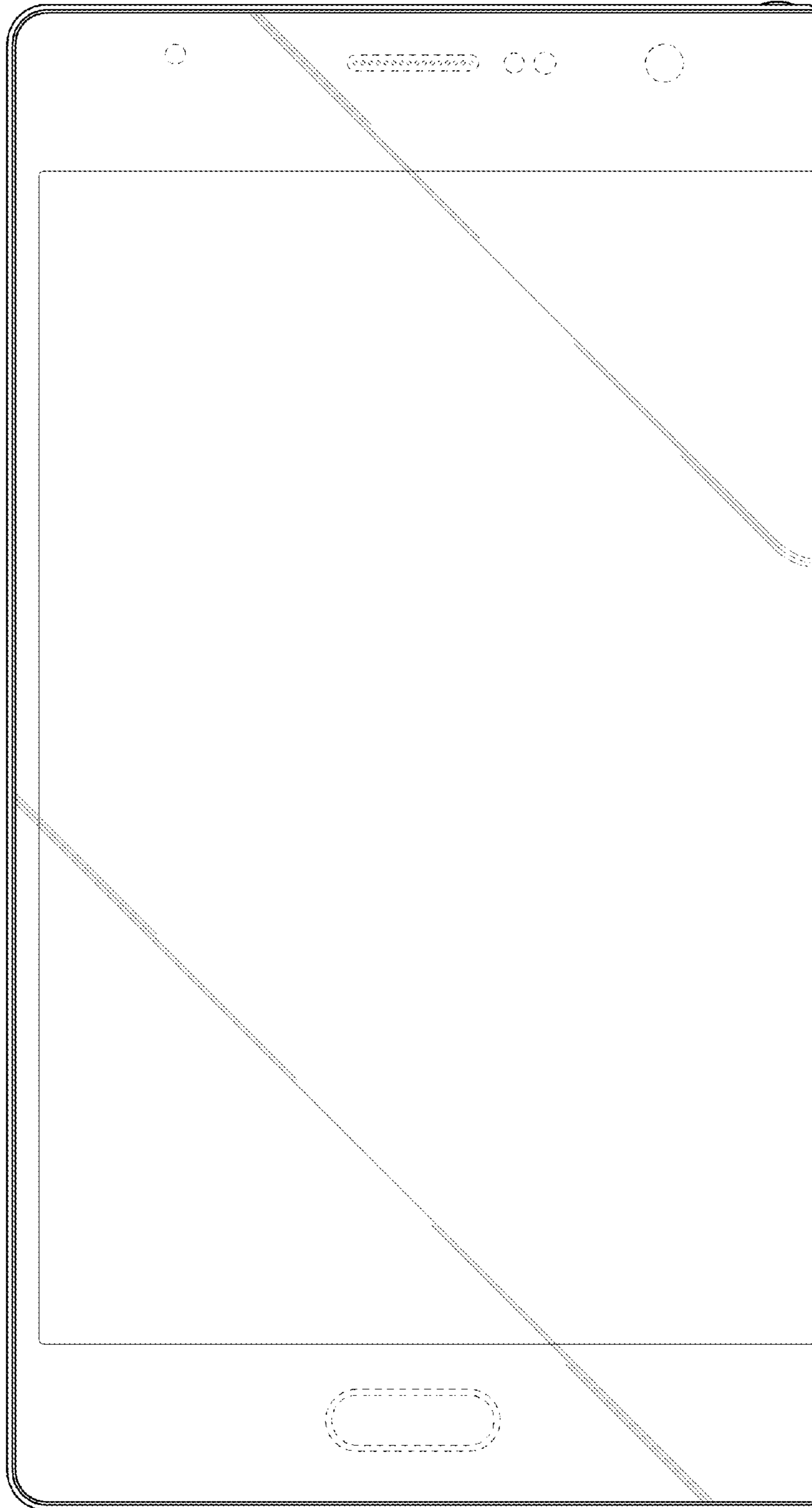

FIG.3

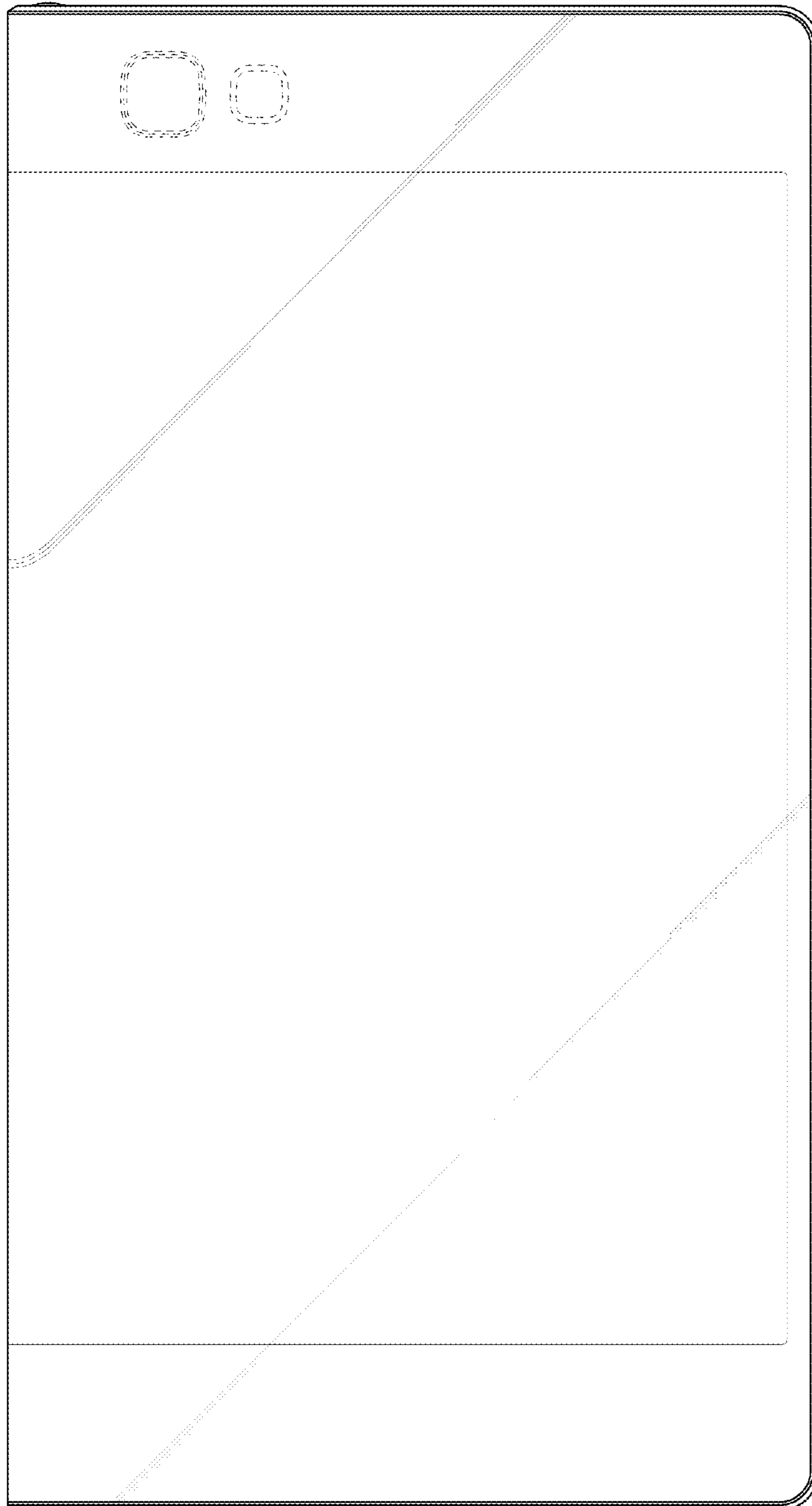

FIG.4

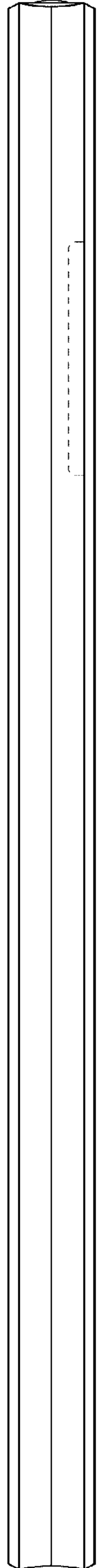

FIG.5

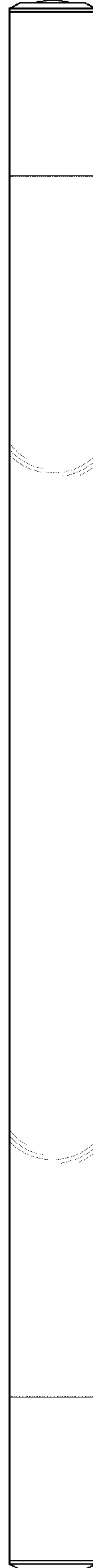

FIG.6

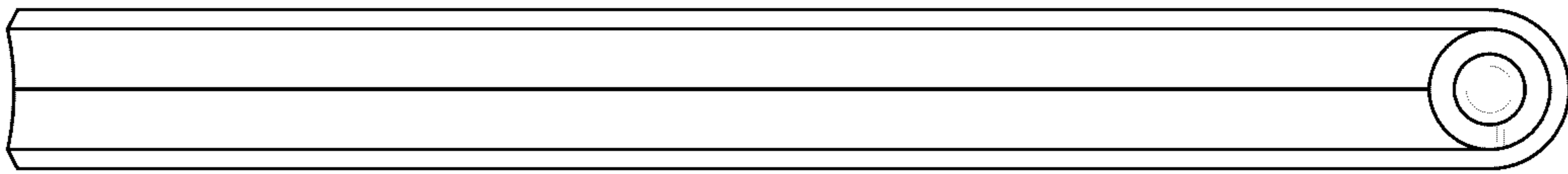

FIG.7



FIG.8

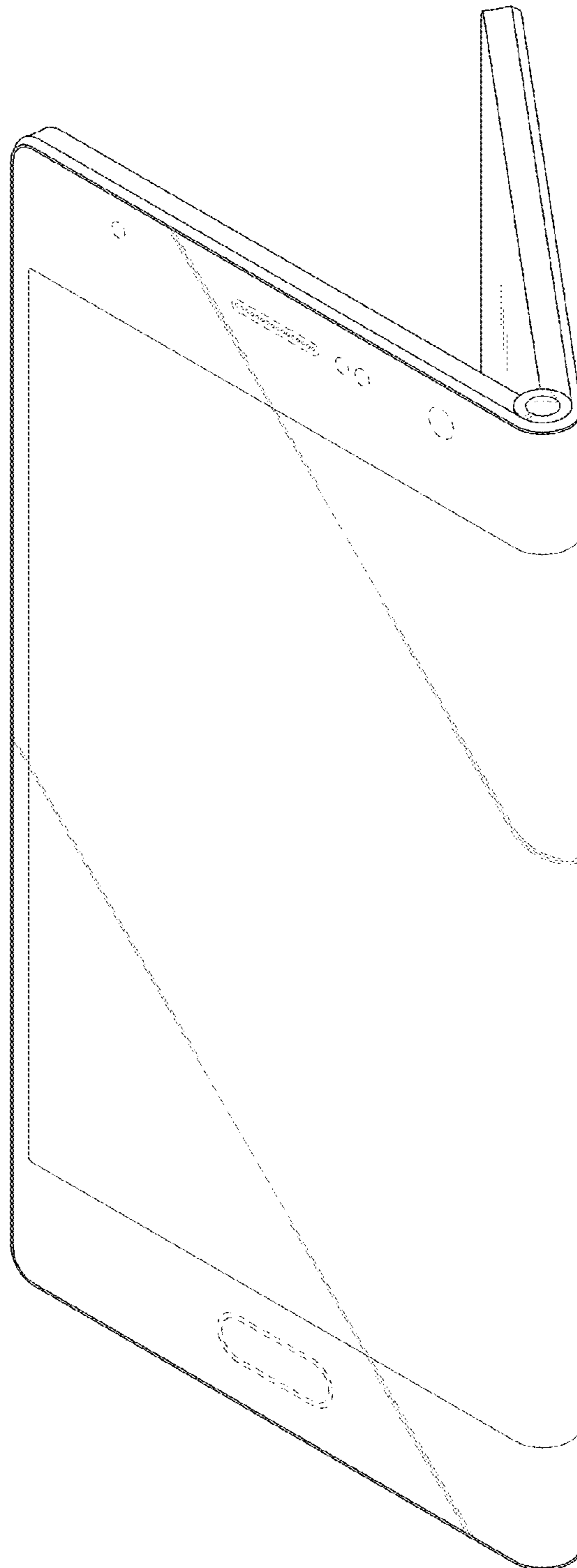



FIG.9

