



US00D775488S

(12) **United States Design Patent** (10) **Patent No.:** **US D775,488 S**
Koning et al. (45) **Date of Patent:** **** *Jan. 3, 2017**

(54) **TABLE LEG**

(71) Applicant: **Gibraltar Inc.**, Zeeland, MI (US)
(72) Inventors: **Paul Frederick Koning**, Holland, MI (US); **Matthew R. Ruster**, Zeeland, MI (US); **Thomas J. Newhouse**, Grand Rapids, MI (US)

(73) Assignee: **GIBRALTAR, INC.**, Zeeland, MI (US)

(*) Notice: This patent is subject to a terminal disclaimer.

(**) Term: **14 Years**

(21) Appl. No.: **29/494,223**

(22) Filed: **Jun. 18, 2014**

(51) **LOC (10) Cl.** **06-06**

(52) **U.S. Cl.**
USPC **D6/706**

(58) **Field of Classification Search**
USPC D6/709, 709.21, 710, 708.23, 718, 648.1, D6/656, 656.12, 656.17

(Continued)

(56) **References Cited**

U.S. PATENT DOCUMENTS

D278,012 S * 3/1985 Doerner D6/610
D557,526 S * 12/2007 Littorin D6/709

(Continued)

Primary Examiner — Mary Ann Calabrese

(74) *Attorney, Agent, or Firm* — McGarry Bair PC

(57) **CLAIM**

The ornamental design for a table leg, as shown and described.

DESCRIPTION

FIG. 1 is a perspective view of a table leg which embodies a first embodiment of our design;

FIG. 2 is a front view thereof;
FIG. 3 is a rear view thereof;
FIG. 4 is a right side view thereof, of which a left side view is a mirror image thereof,
FIG. 5 is top view thereof;
FIG. 6 is a bottom view thereof;
FIG. 7 is a perspective view of a table leg which embodies a second embodiment of our design;
FIG. 8 is a front view thereof;
FIG. 9 is a rear view thereof;
FIG. 10 is a right side view thereof, of which a left side view is a mirror image thereof,
FIG. 11 is a top view thereof;
FIG. 12 is a bottom view thereof;
FIG. 13 is a perspective view of a table leg which embodies a third embodiment of our design;
FIG. 14 is a front view thereof;
FIG. 15 is a rear view thereof;
FIG. 16 is a right side view thereof, of which a left side view is a mirror image thereof,
FIG. 17 is a top view thereof;
FIG. 18 is a bottom view thereof;
FIG. 19 is a perspective view of a table leg which embodies a fourth embodiment of our design;
FIG. 20 is a front view thereof;
FIG. 21 is a rear view thereof;
FIG. 22 is a right side view thereof, of which a left side view is a mirror image thereof,
FIG. 23 is a top view thereof;
FIG. 24 is a bottom view thereof;
FIG. 25 is a perspective view of a table leg which embodies a fifth embodiment of our design;
FIG. 26 is a front view thereof;
FIG. 27 is a rear view thereof;
FIG. 28 is a right side view thereof, of which a left side view is a mirror image thereof,
FIG. 29 is a top view thereof;
FIG. 30 is a bottom view thereof;
FIG. 31 is a perspective view of a table leg which embodies a sixth embodiment of our design;
FIG. 32 is a front view thereof;
FIG. 33 is a rear view thereof;

(Continued)

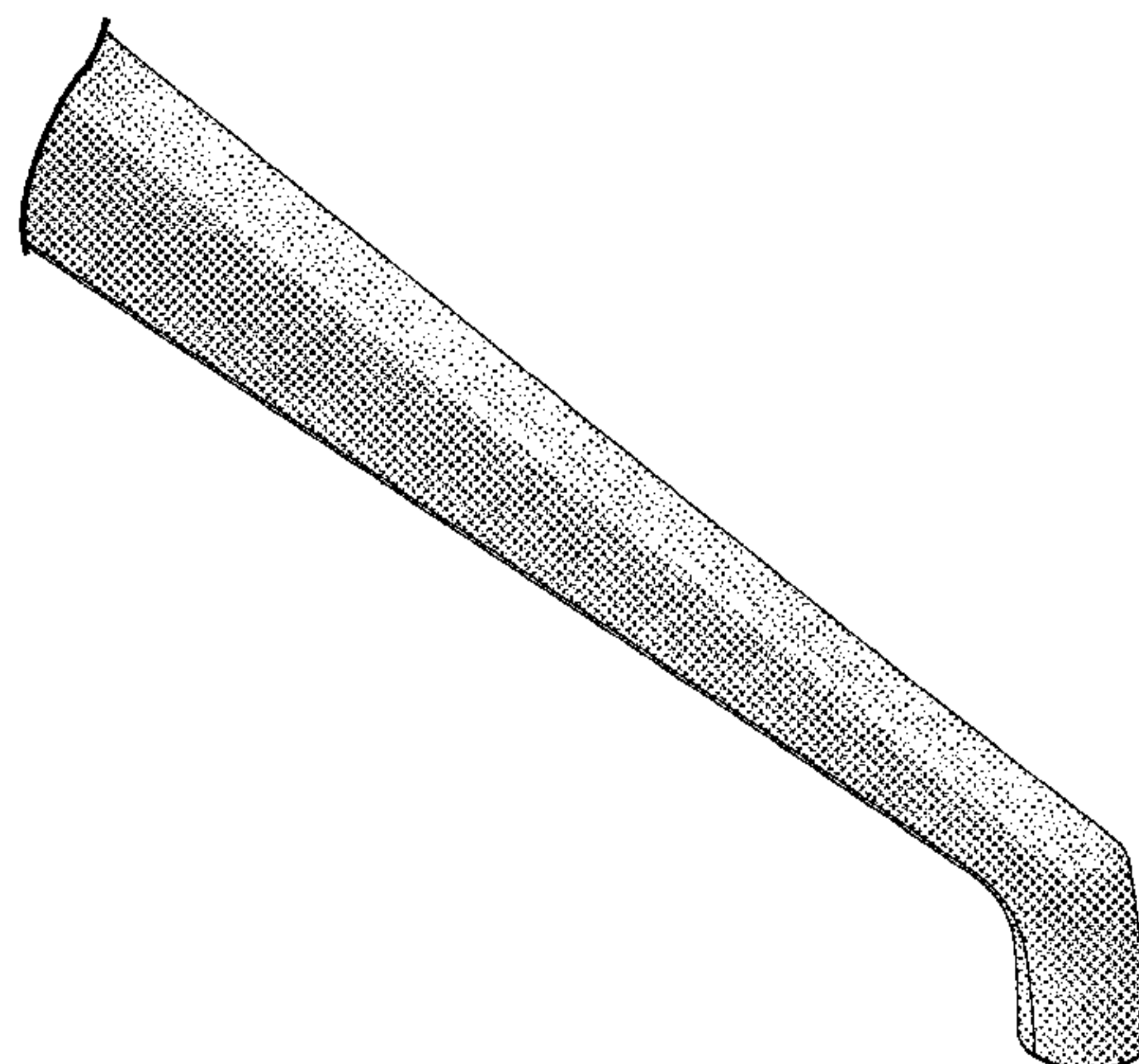

FIG. 34 is a right side view thereof, of which a left side view is a mirror image thereof;
FIG. 35 is a top view thereof;
FIG. 36 is a bottom view thereof;
FIG. 37 is a perspective view of the first environment of our table leg design showing the design in an alternate embodiment;
FIG. 38 is a front view thereof;
FIG. 39 is a rear view thereof;
FIG. 40 is a right side view thereof, of which a left side view is a mirror image thereof;
FIG. 41 is a top view thereof;
FIG. 42 is a bottom view thereof;
FIG. 43 is a perspective view of the first environment of our table leg design showing the design in an alternate embodiment;
FIG. 44 is a front view thereof;
FIG. 45 is a rear view thereof;
FIG. 46 is a right side view thereof, of which a left side view is a mirror image thereof;
FIG. 47 is a top view thereof;
FIG. 48 is a bottom view thereof;
FIG. 49 is a perspective view of the first environment of our table leg design showing the design in an alternate embodiment;
FIG. 50 is a front view thereof;

FIG. 51 is a rear view thereof;
FIG. 52 is a right side view thereof, of which a left side view is a mirror image thereof;
FIG. 53 is a top view thereof; and,
FIG. 54 is a bottom view thereof.
The details shown in broken lines form no part of the design.

1 Claim, 18 Drawing Sheets

(58) **Field of Classification Search**

CPC A47C 19/024; A47C 19/025; A47C 19/02;
A47B 91/00; A47B 13/00; A47B
2013/2013; A47B 2013/025; A47B
91/02; A47B 91/022; A47B 2200/0052;
A47B 2200/005

See application file for complete search history.

(56)

References Cited

U.S. PATENT DOCUMENTS

D569,136	S	*	5/2008	Pearsons	D6/708.23
D622,984	S	*	9/2010	Babick	D6/709
D653,479	S	*	2/2012	Babick	D6/709
D759,412	S	*	6/2016	Koning	D6/709

* cited by examiner

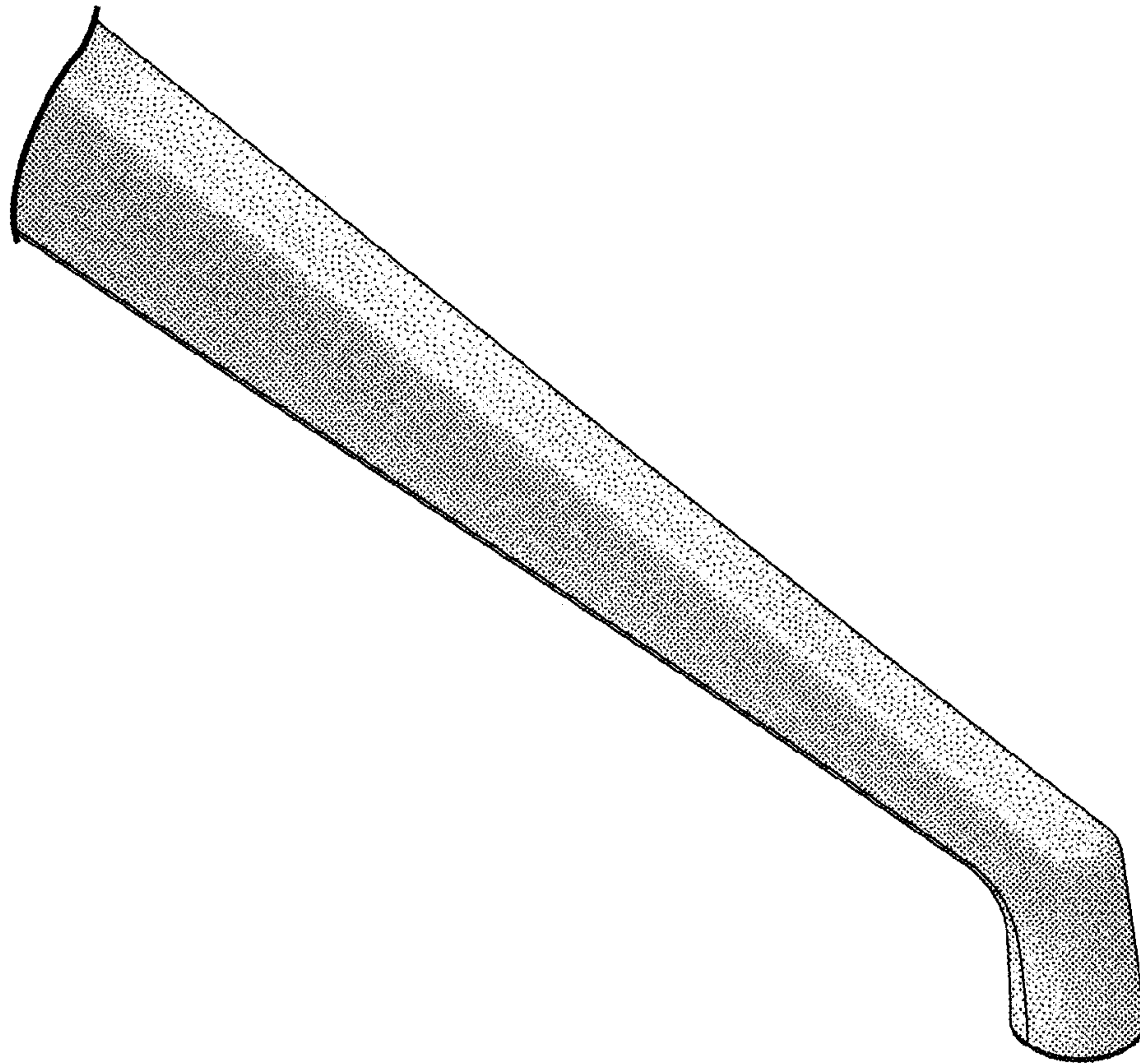

FIG. 1

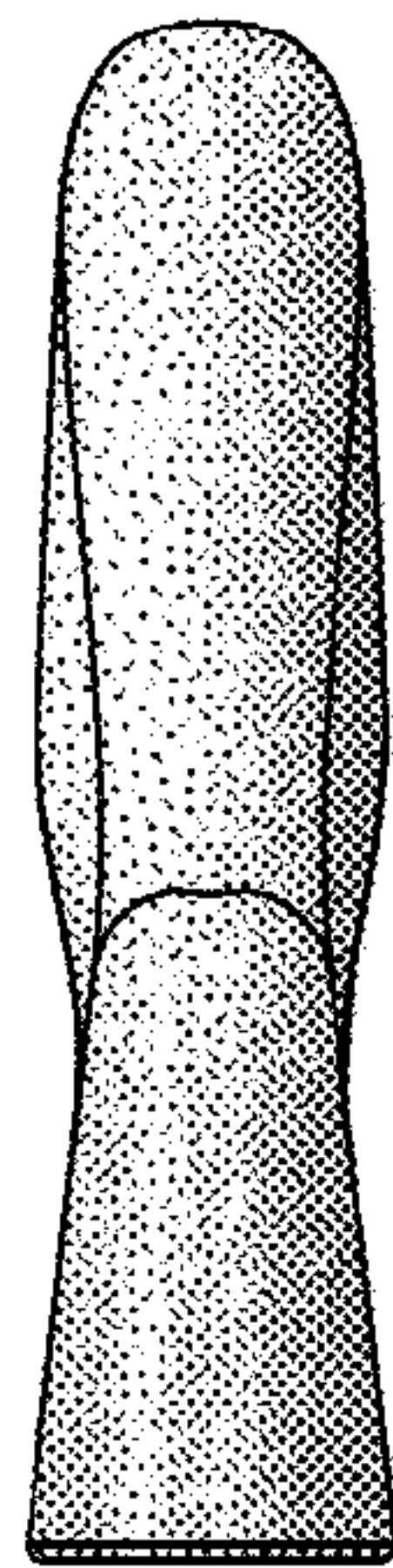

FIG. 2



FIG. 3

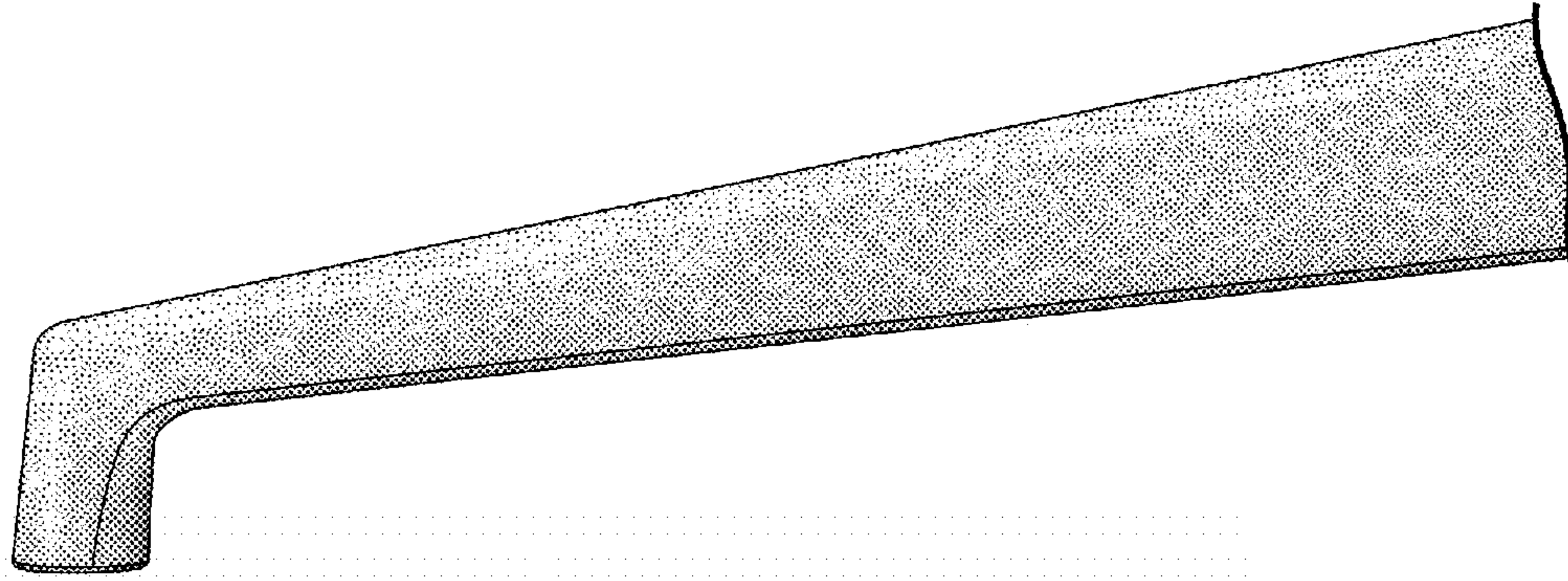

FIG. 4

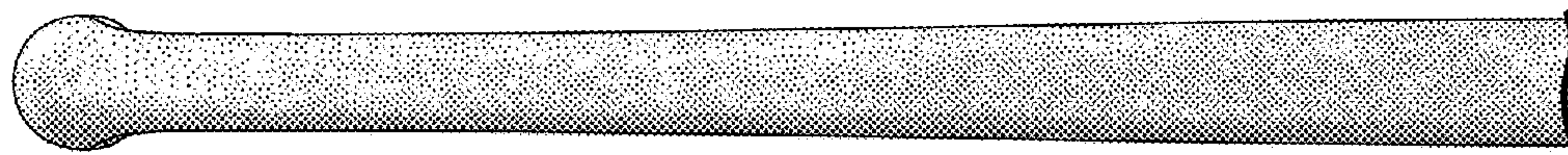

FIG. 5

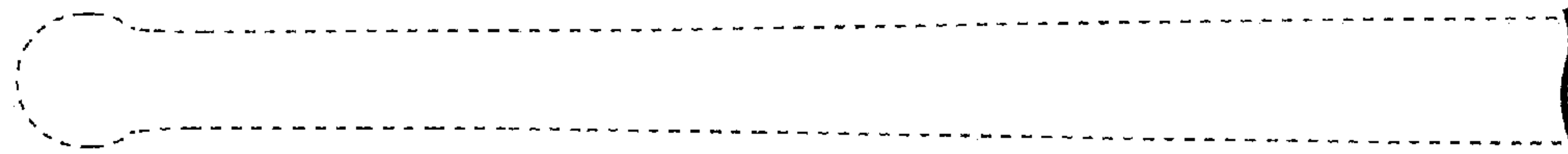

FIG. 6

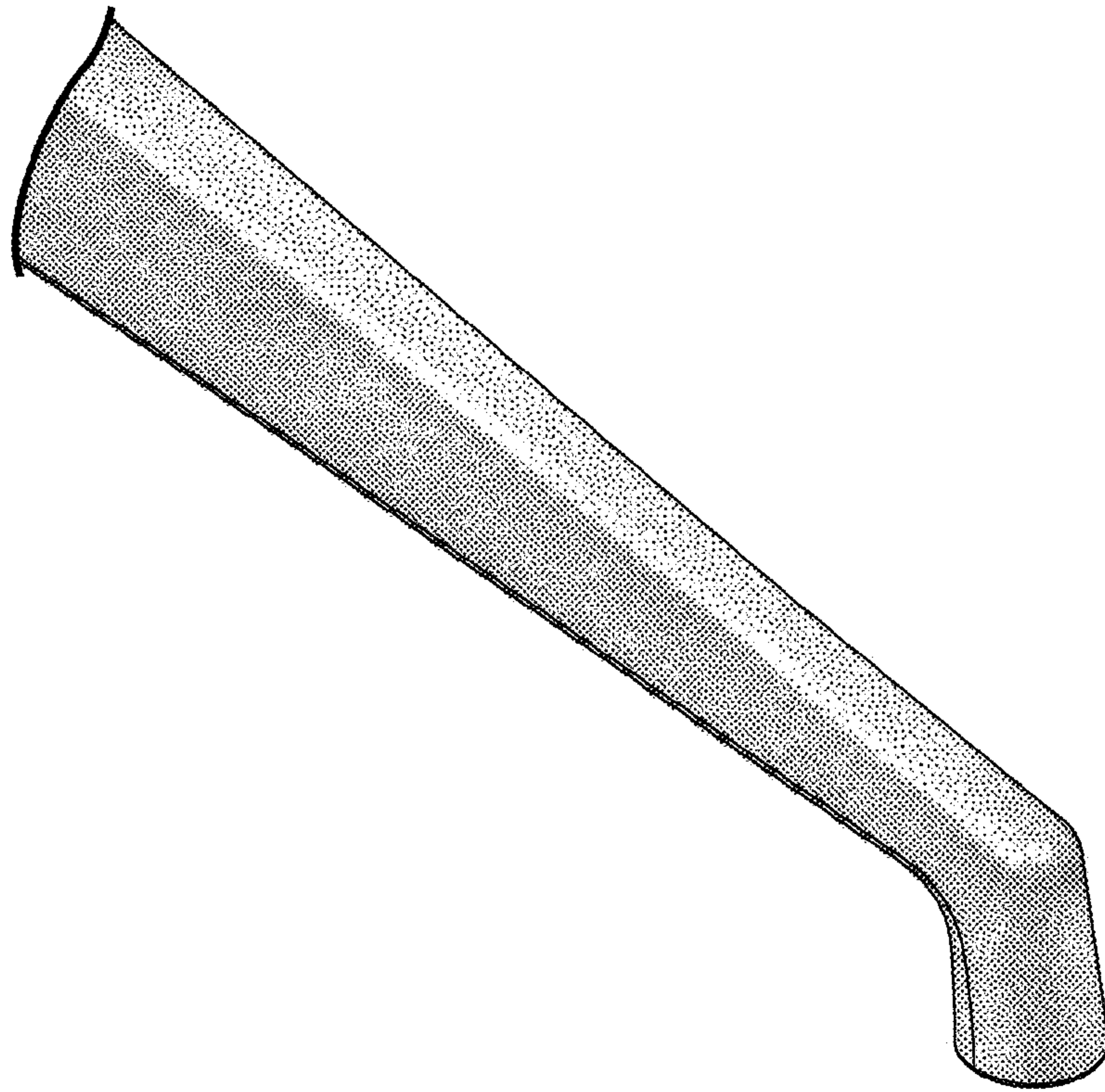

FIG. 7

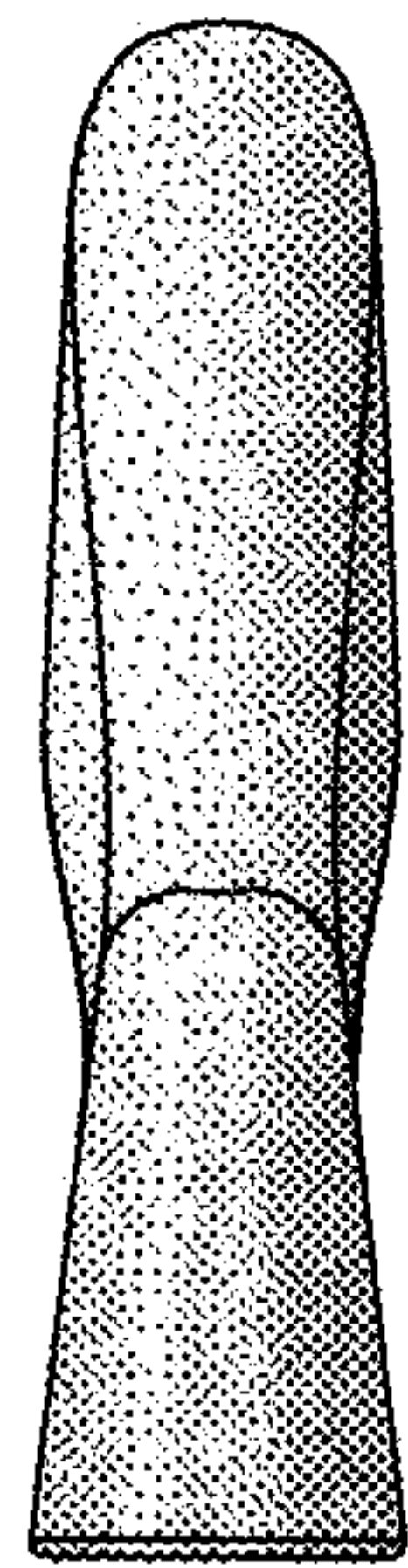

FIG. 8

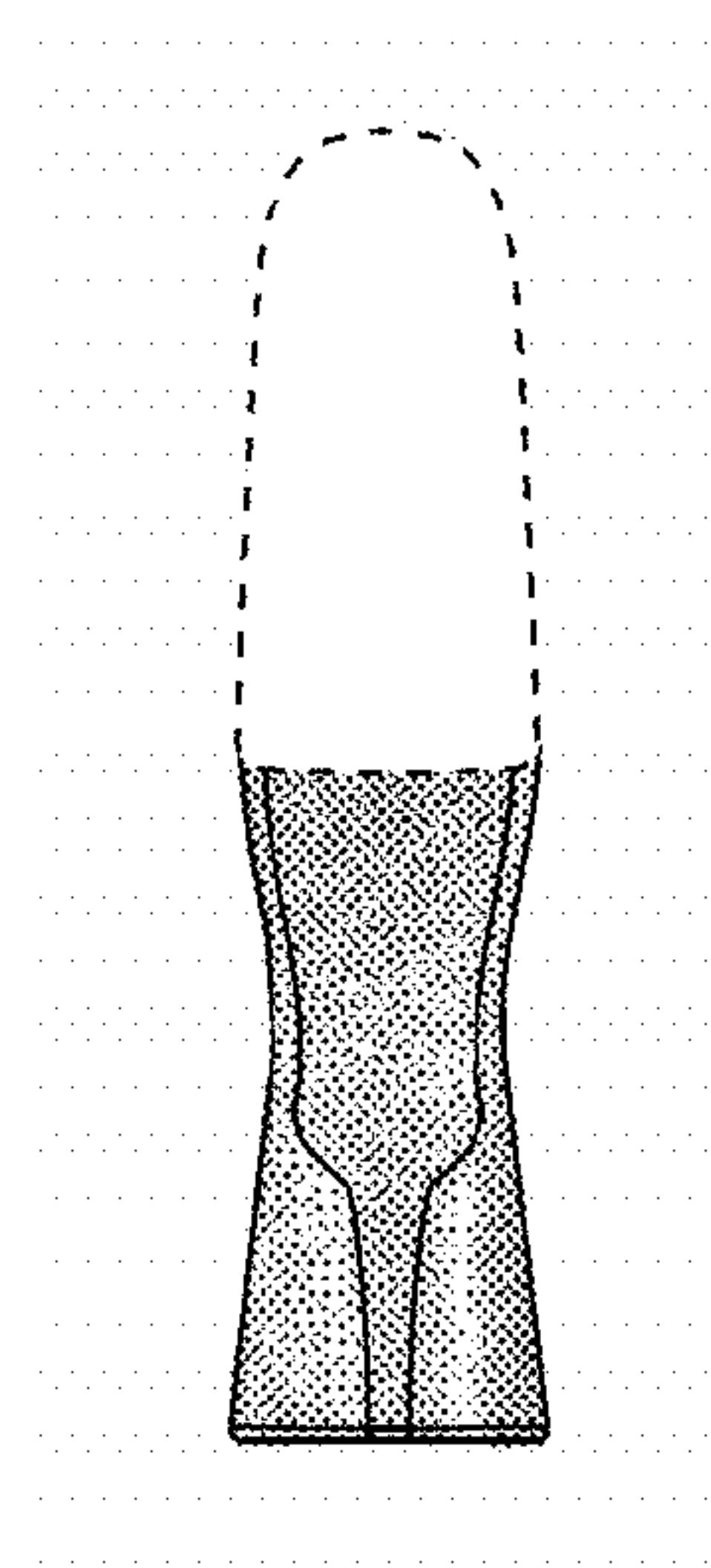

FIG. 9

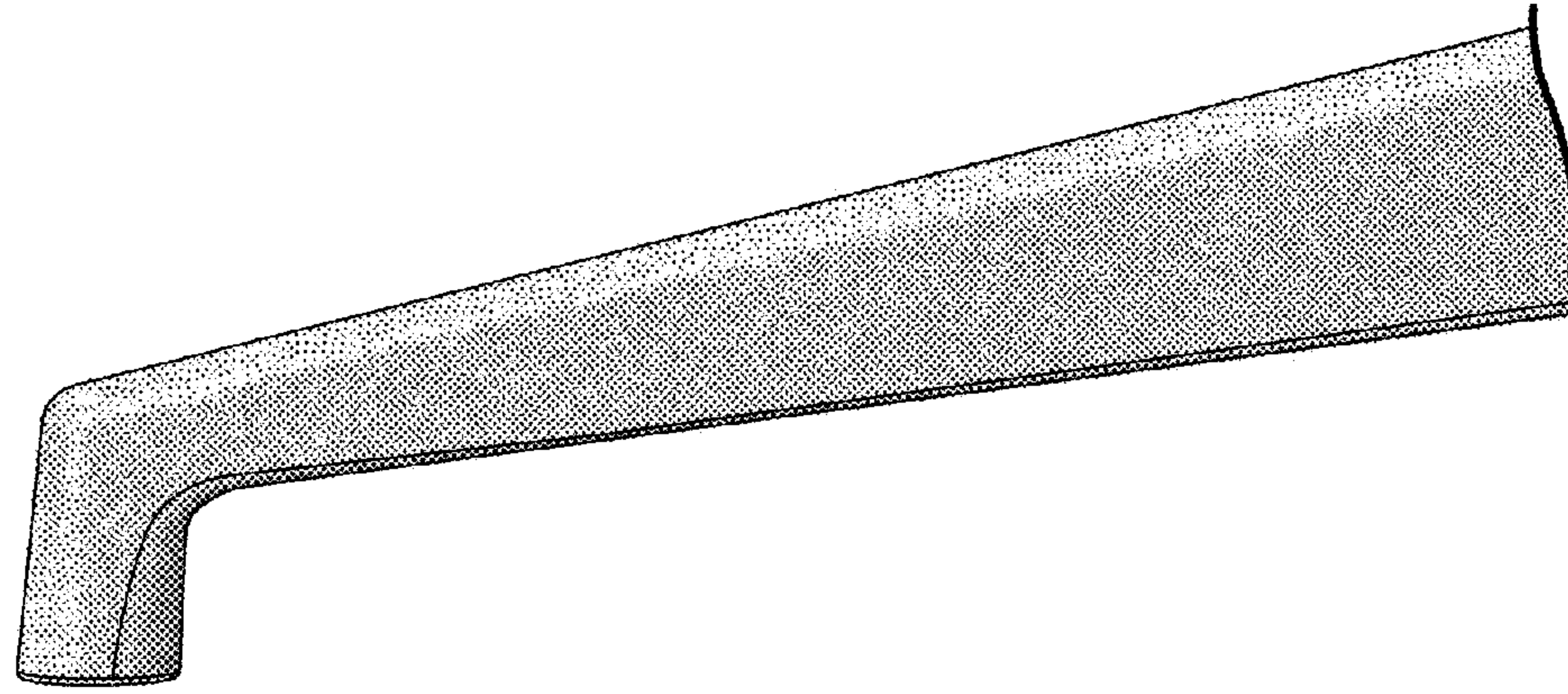

FIG. 10

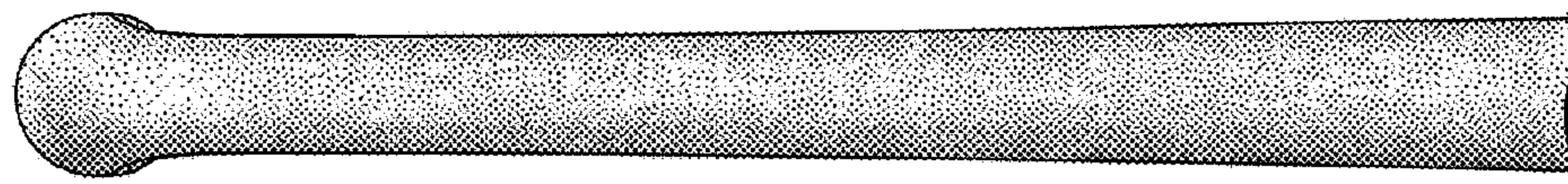

FIG. 11

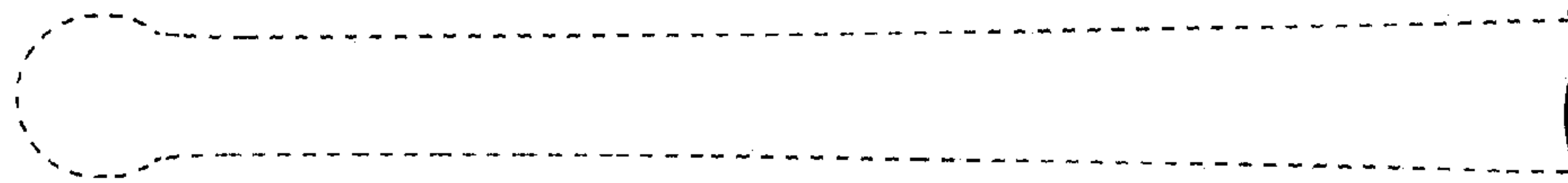

FIG. 12

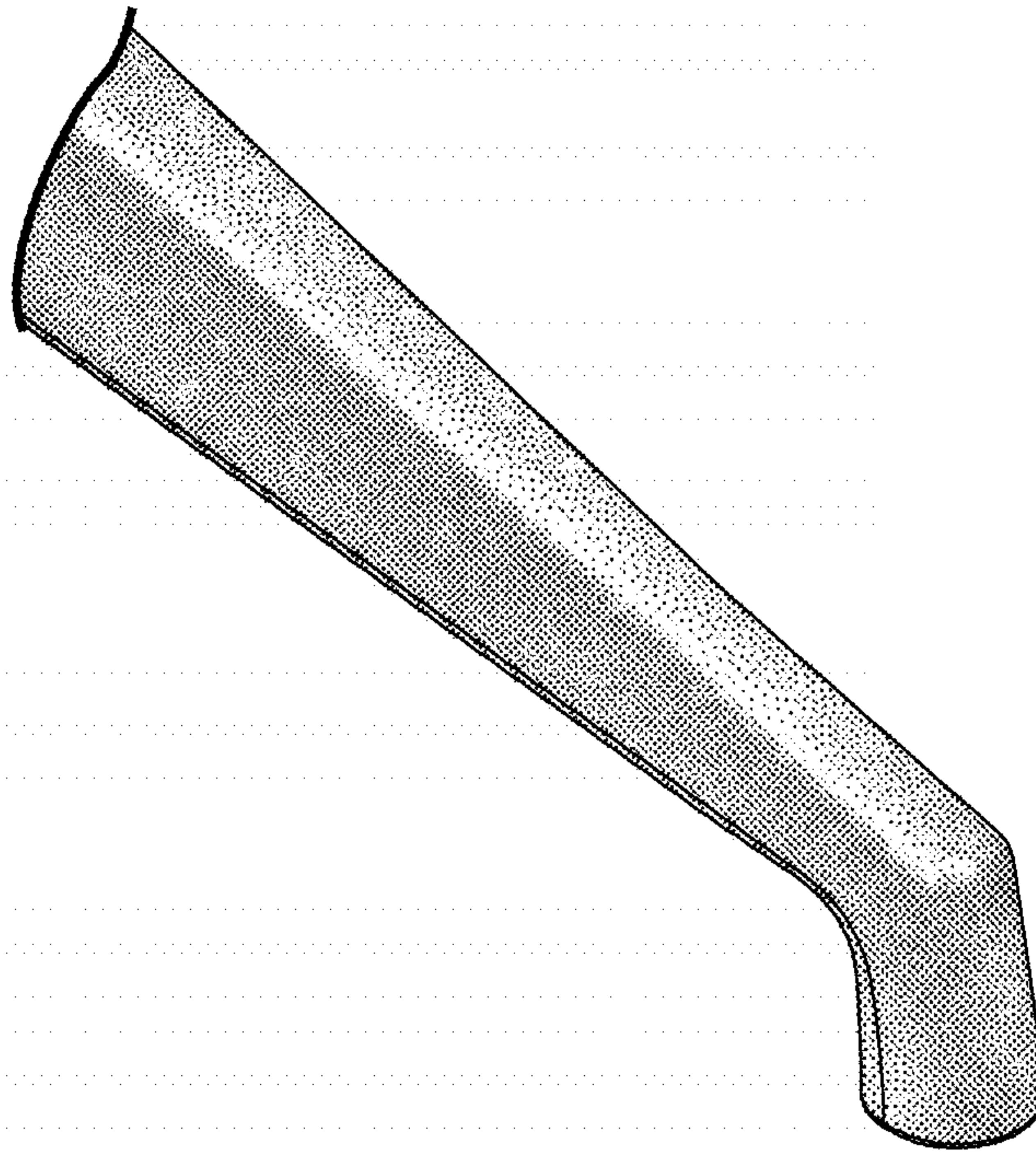

FIG. 13

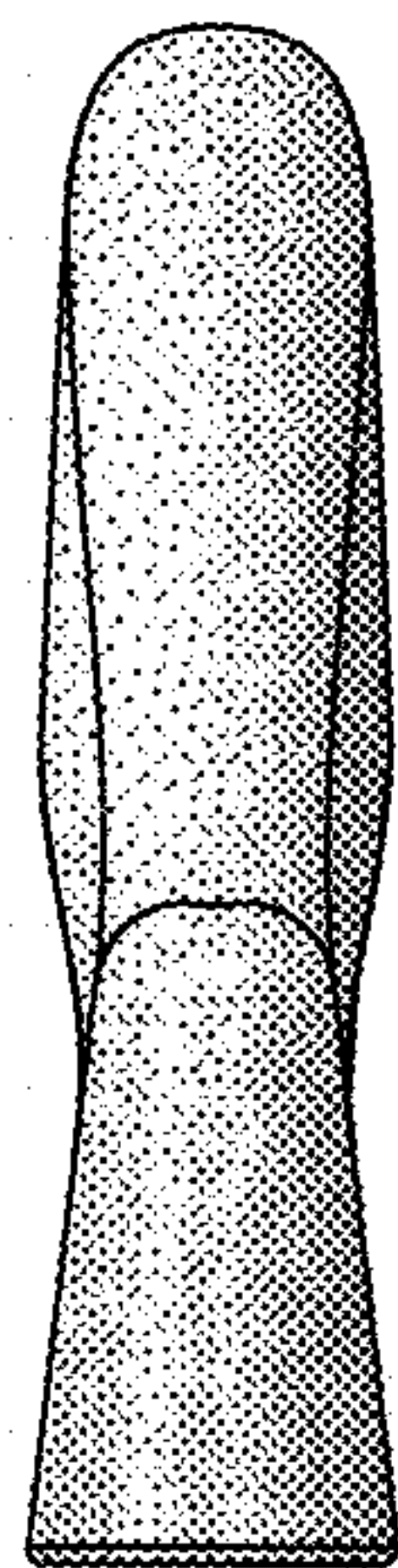

FIG. 14



FIG. 15

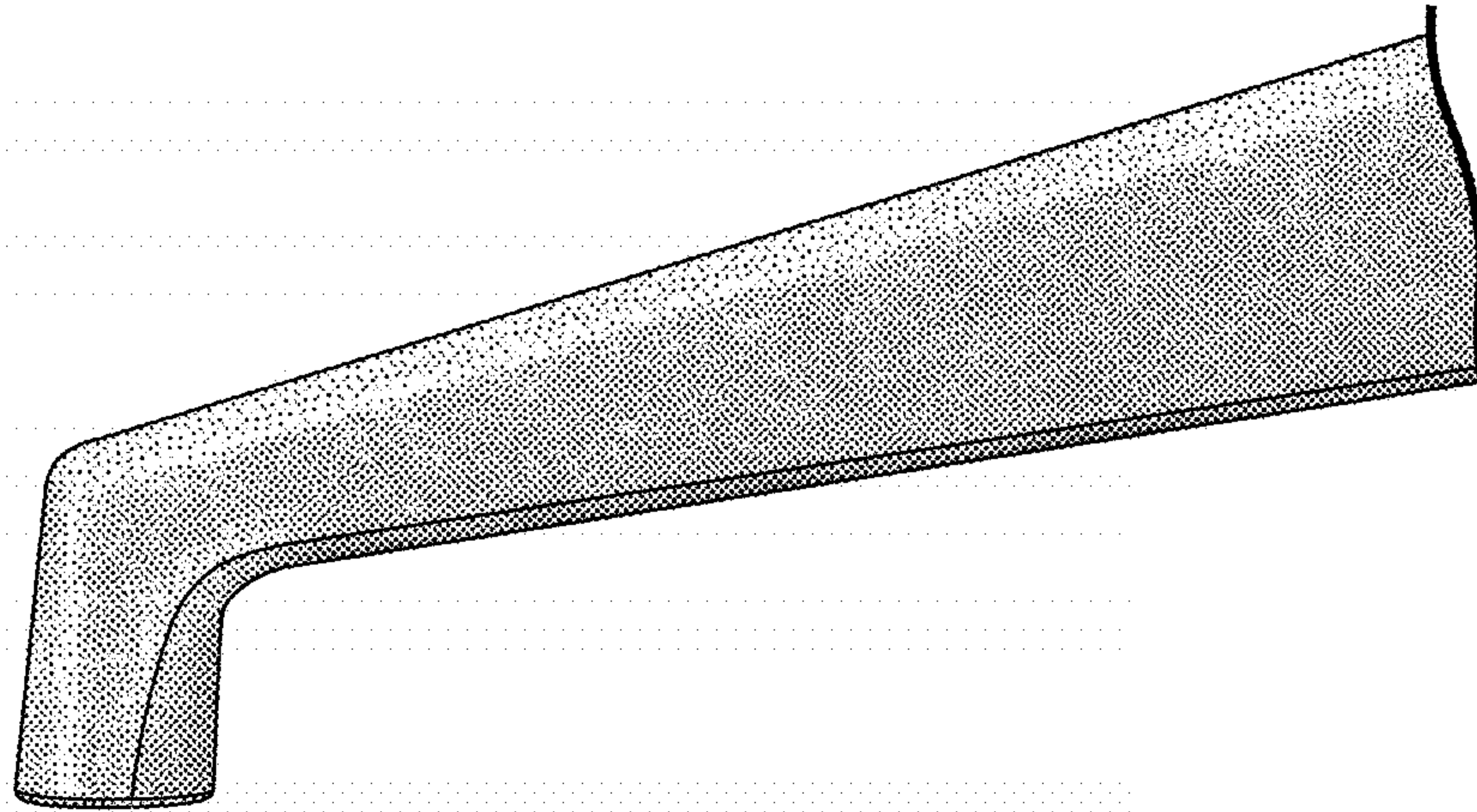

FIG. 16

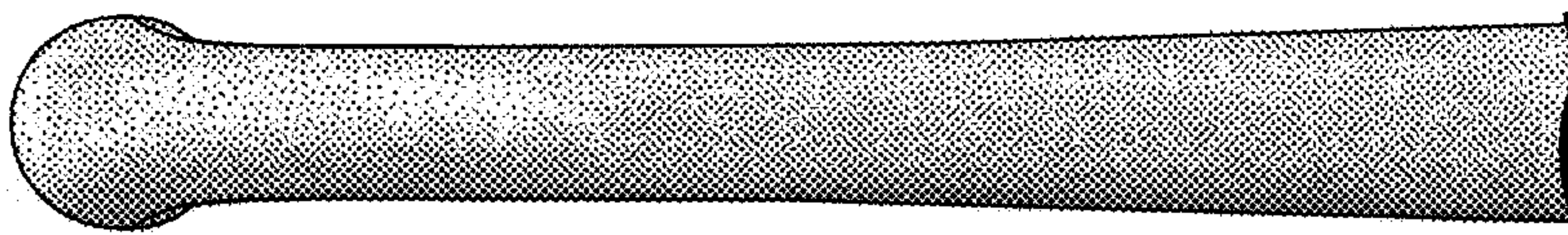

FIG. 17

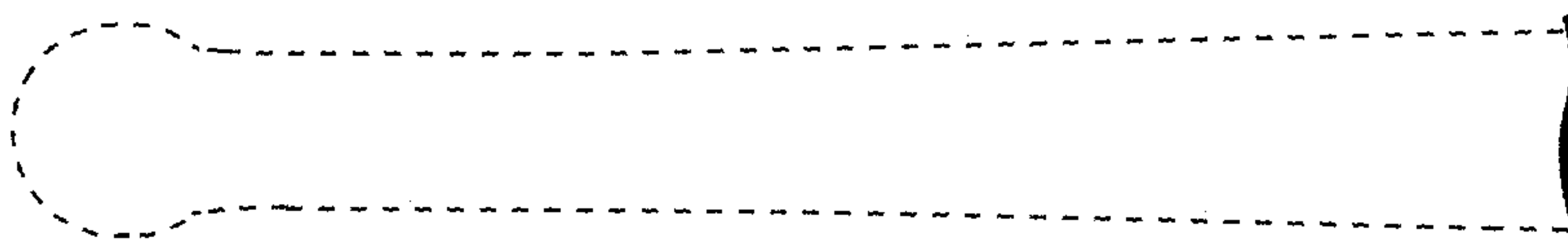

FIG. 18

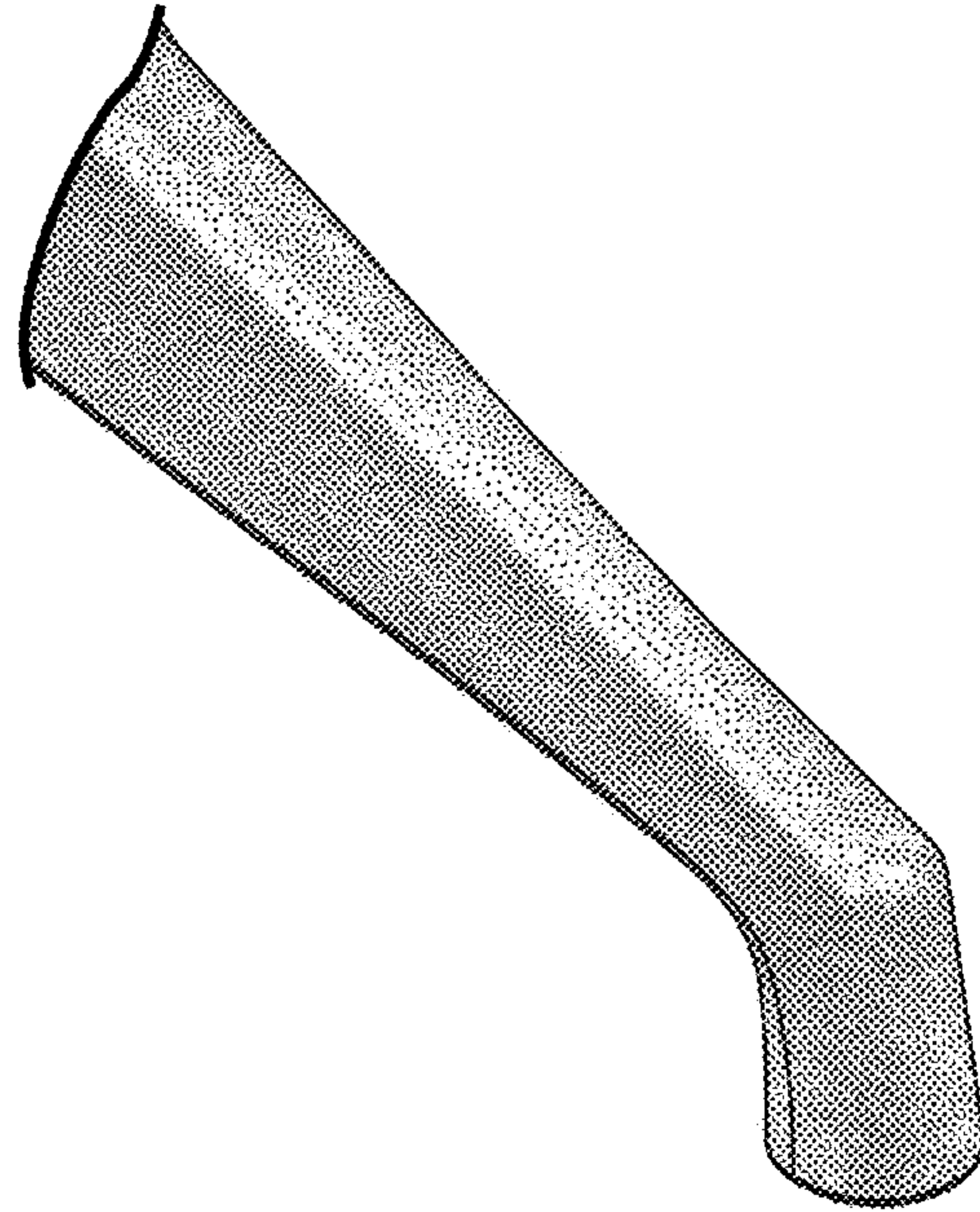

FIG. 19

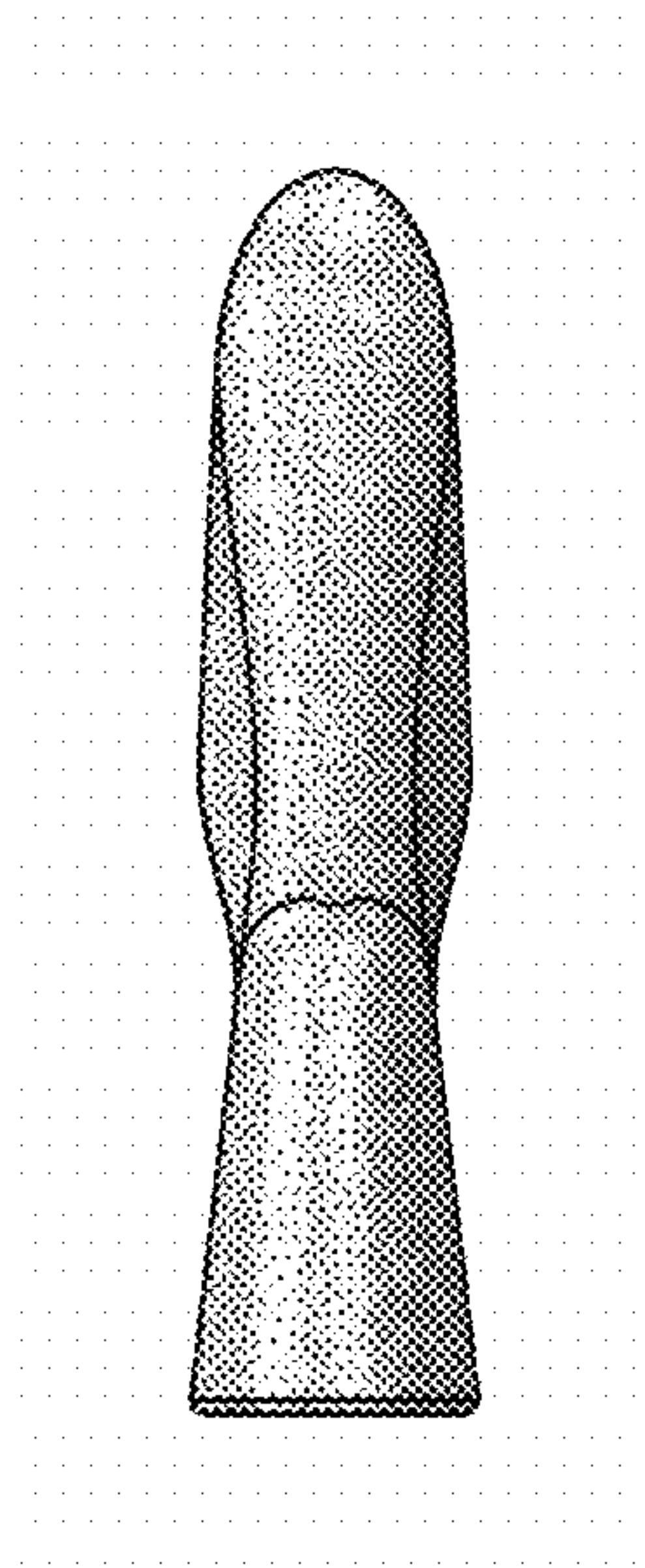

FIG. 20



FIG. 21

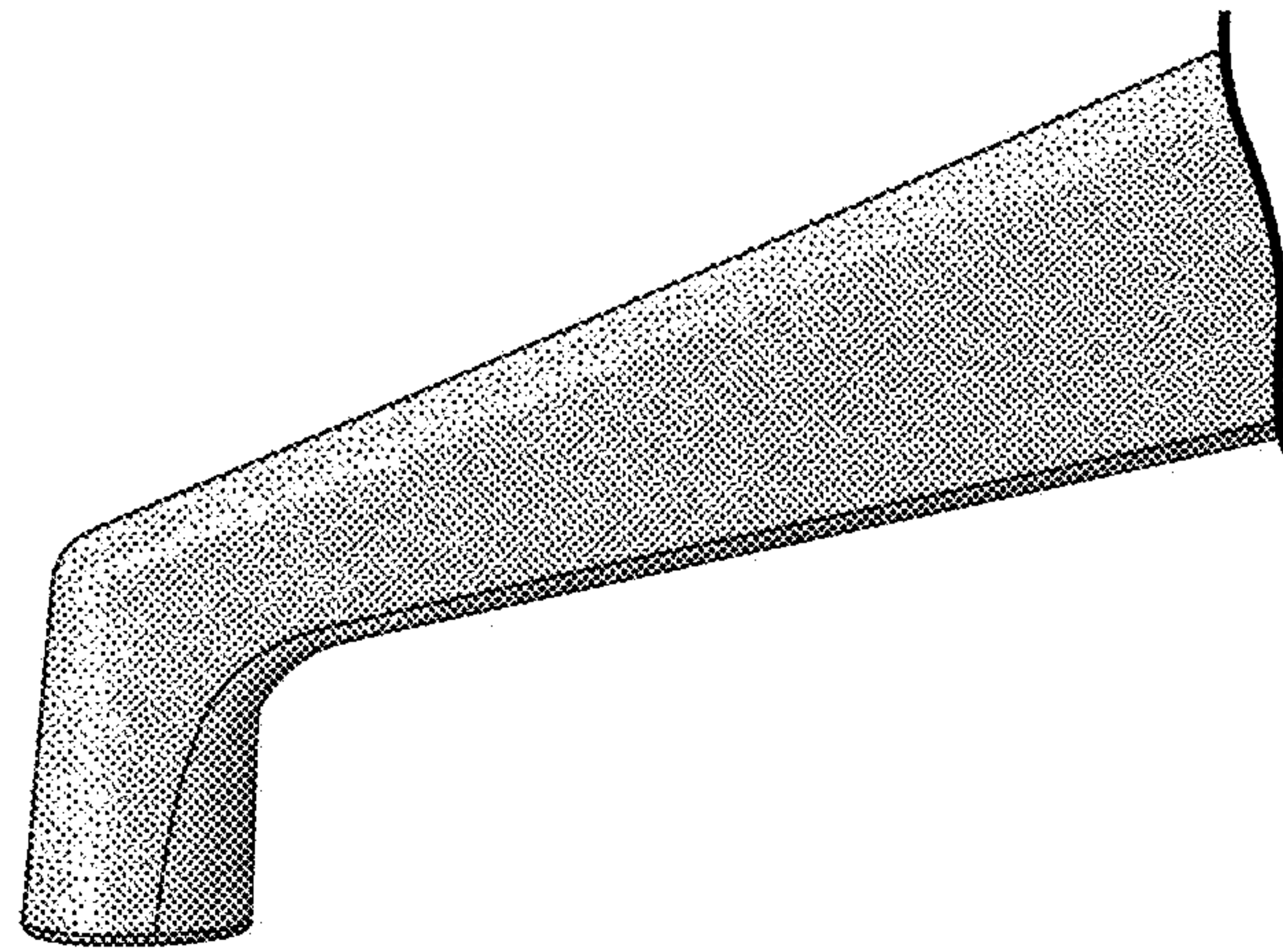

FIG. 22

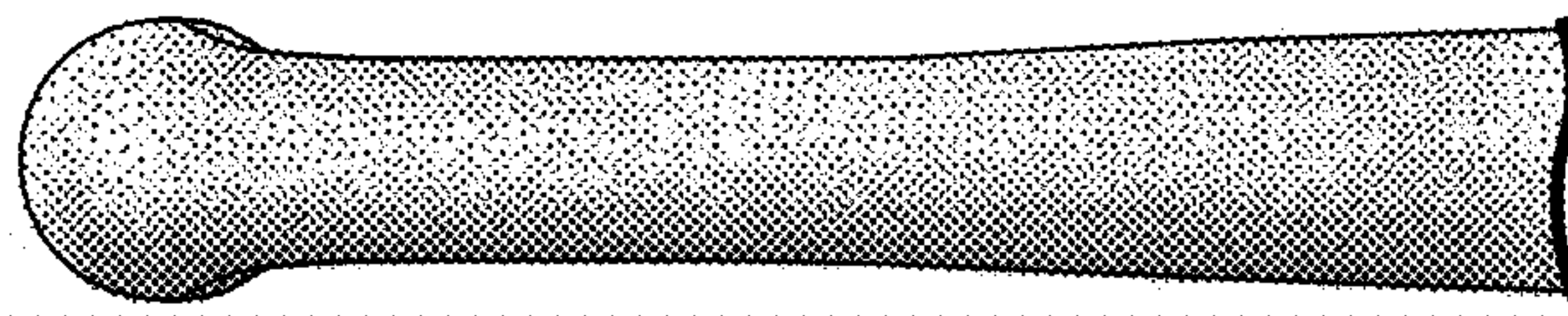

FIG. 23

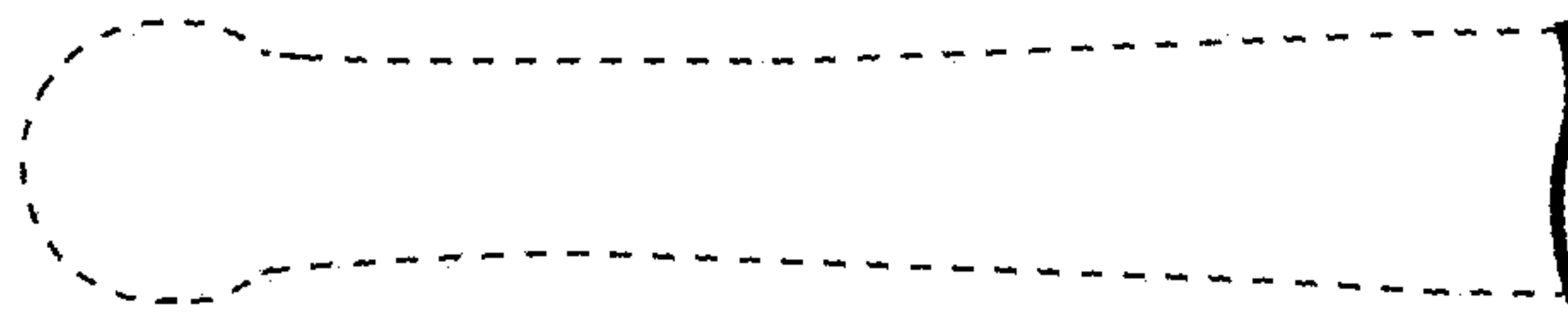

FIG. 24

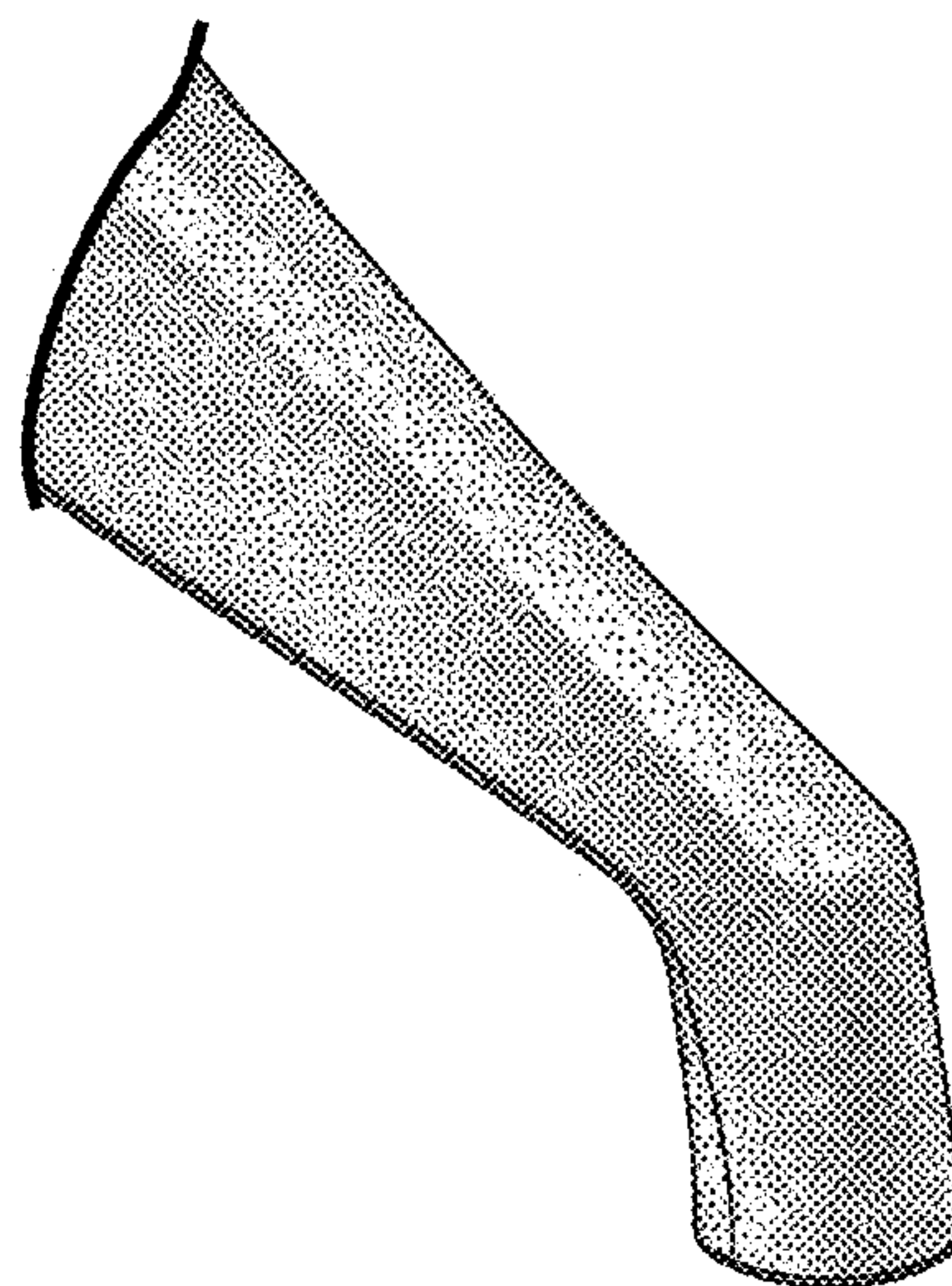

FIG. 25

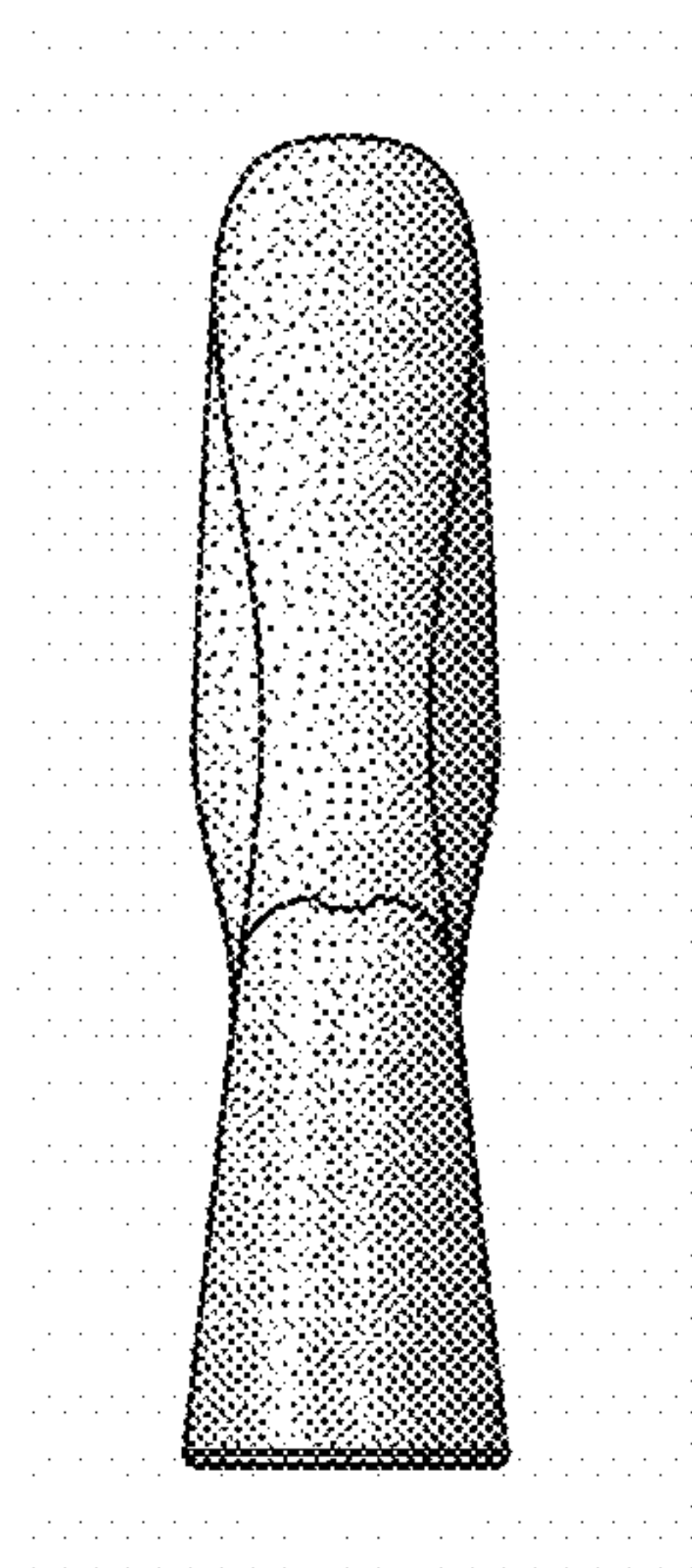

FIG. 26



FIG. 27

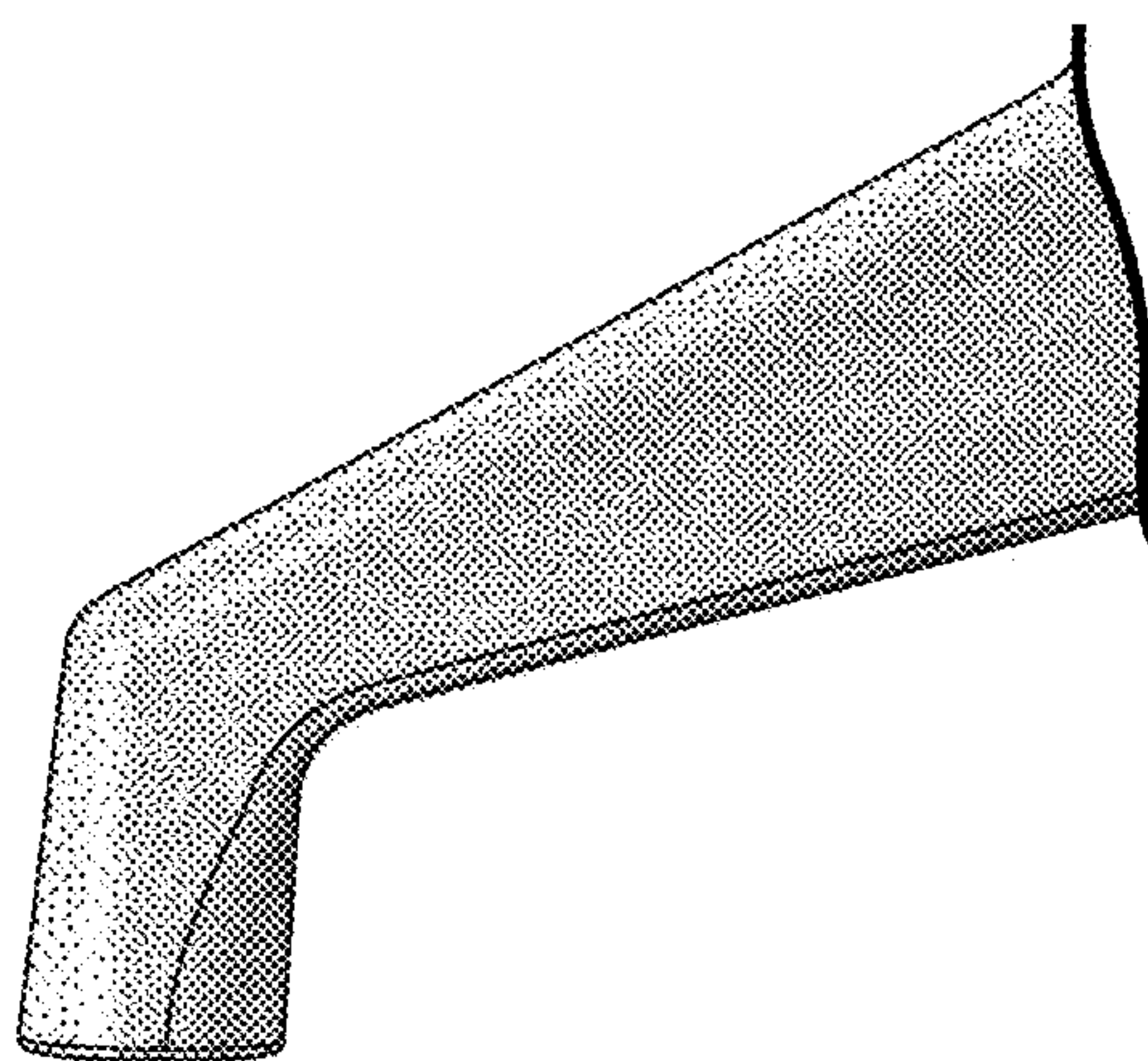

FIG. 28

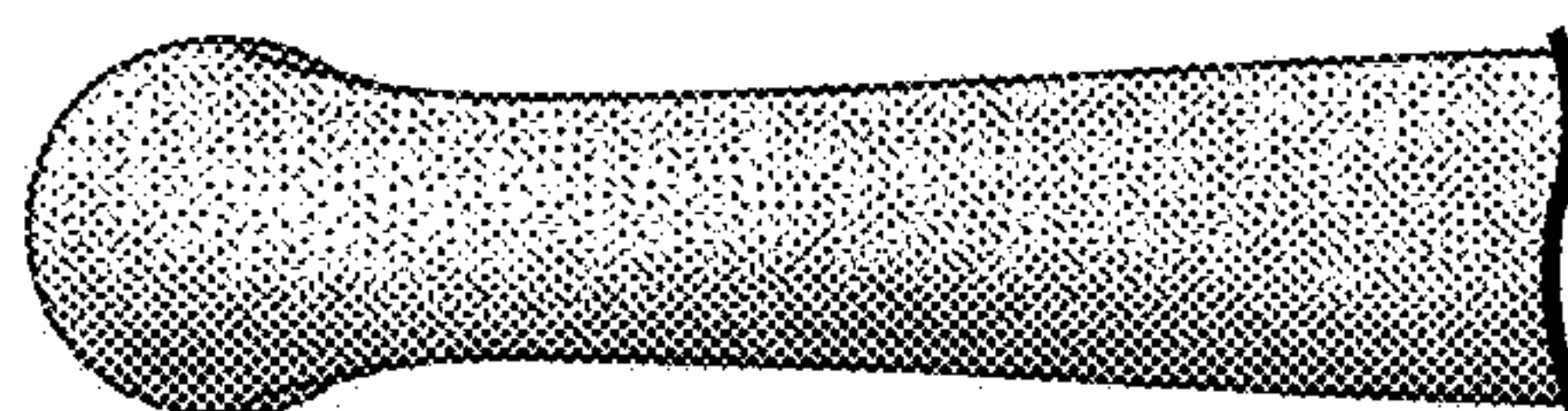

FIG. 29

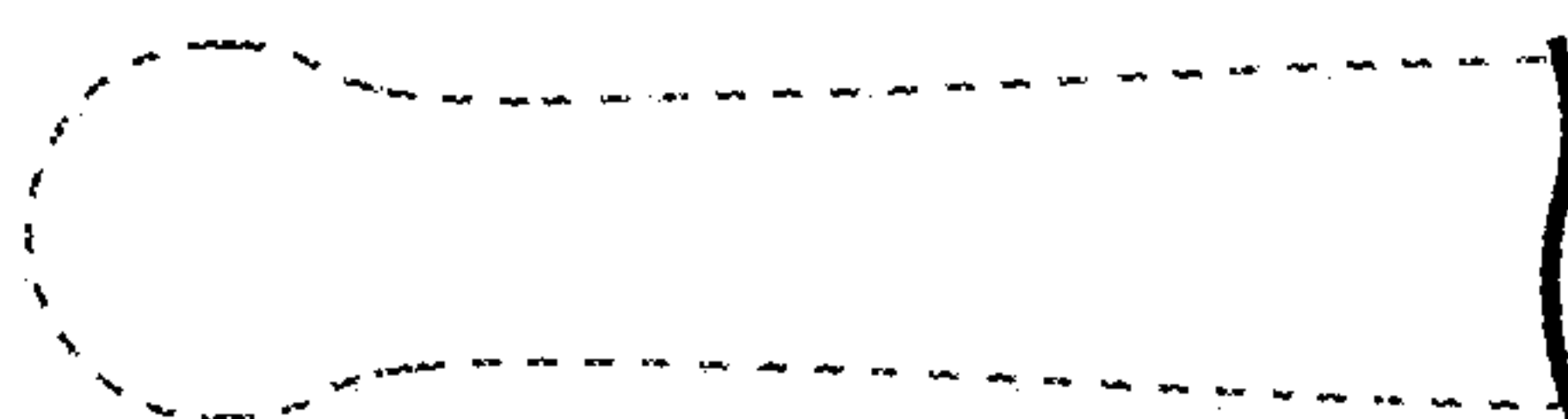

FIG. 30

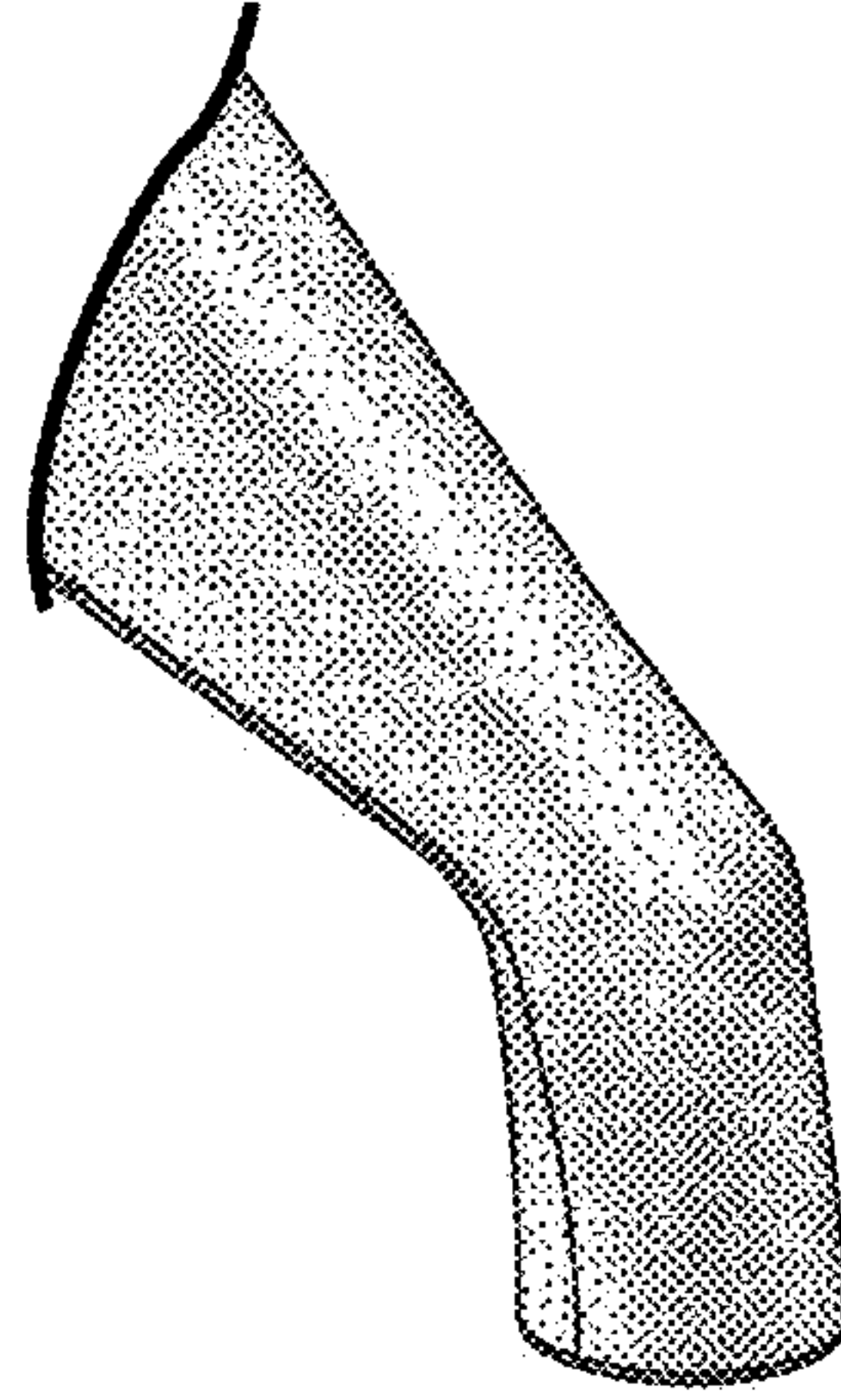

FIG. 31

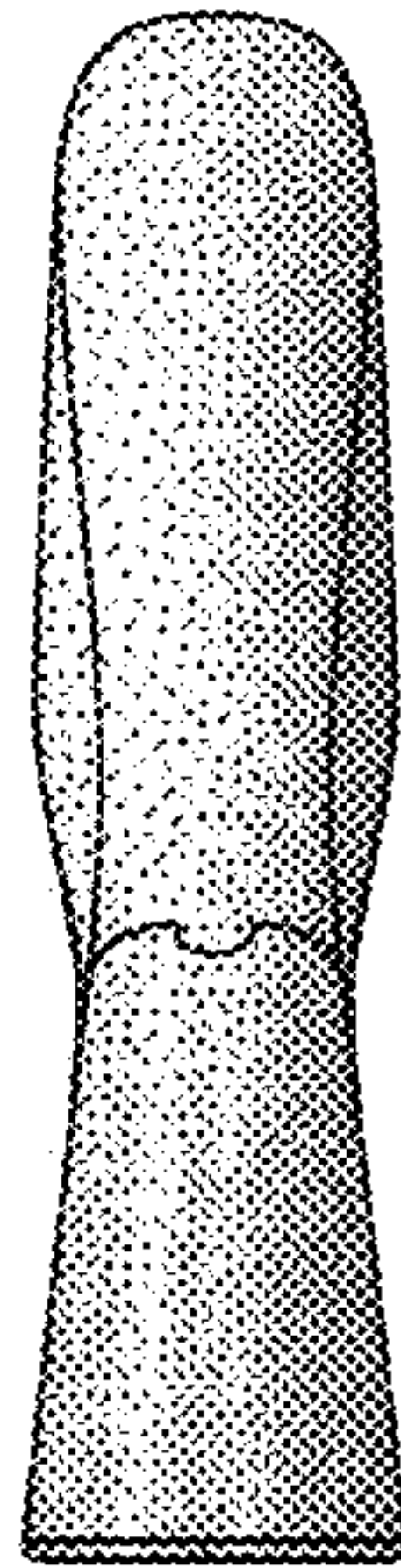

FIG. 32



FIG. 33

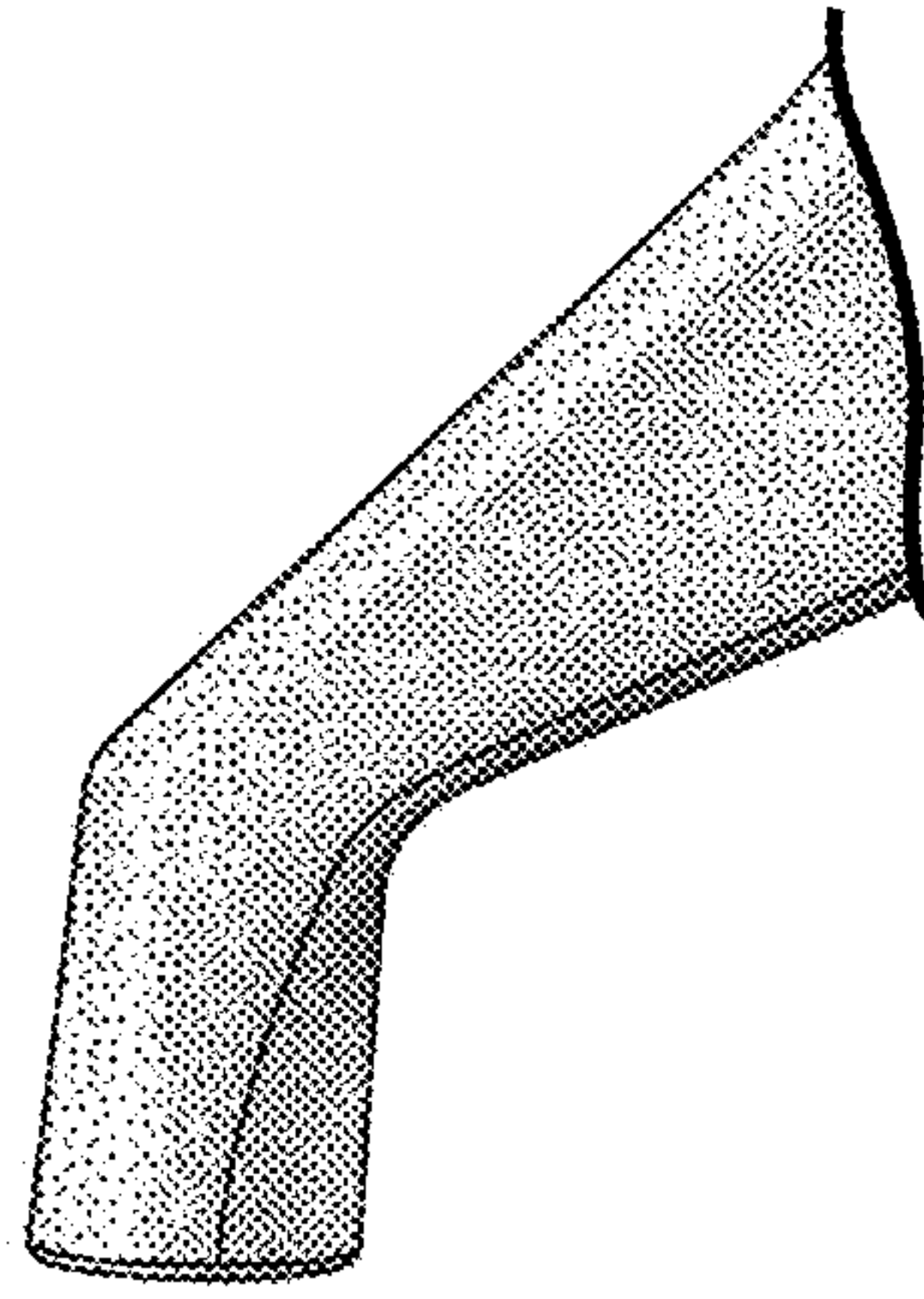

FIG. 34

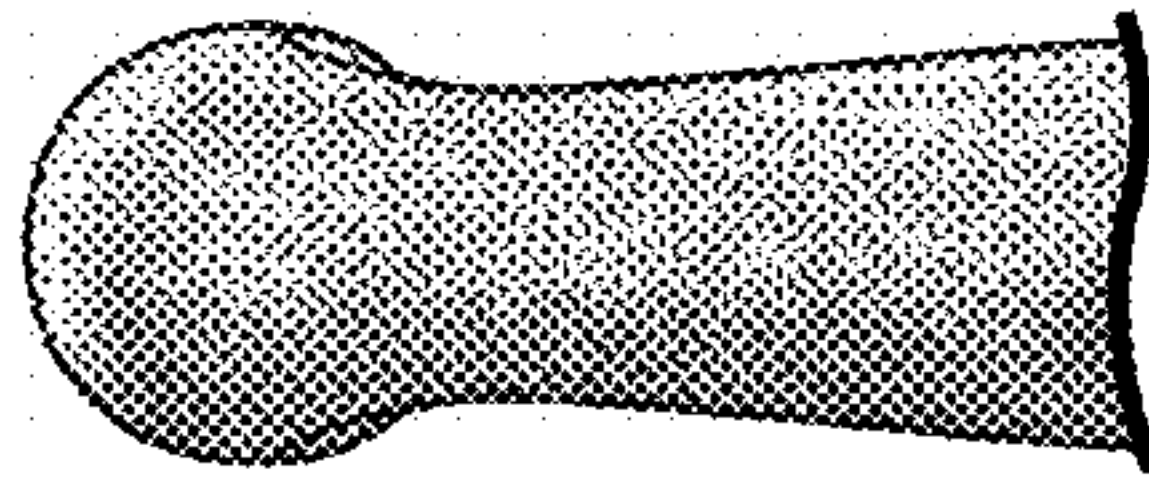

FIG. 35

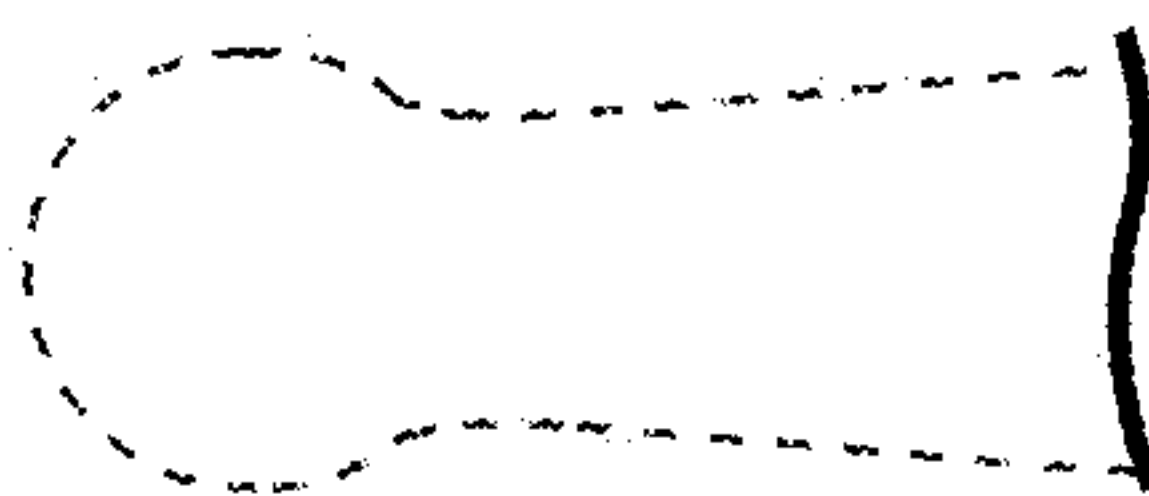

FIG. 36

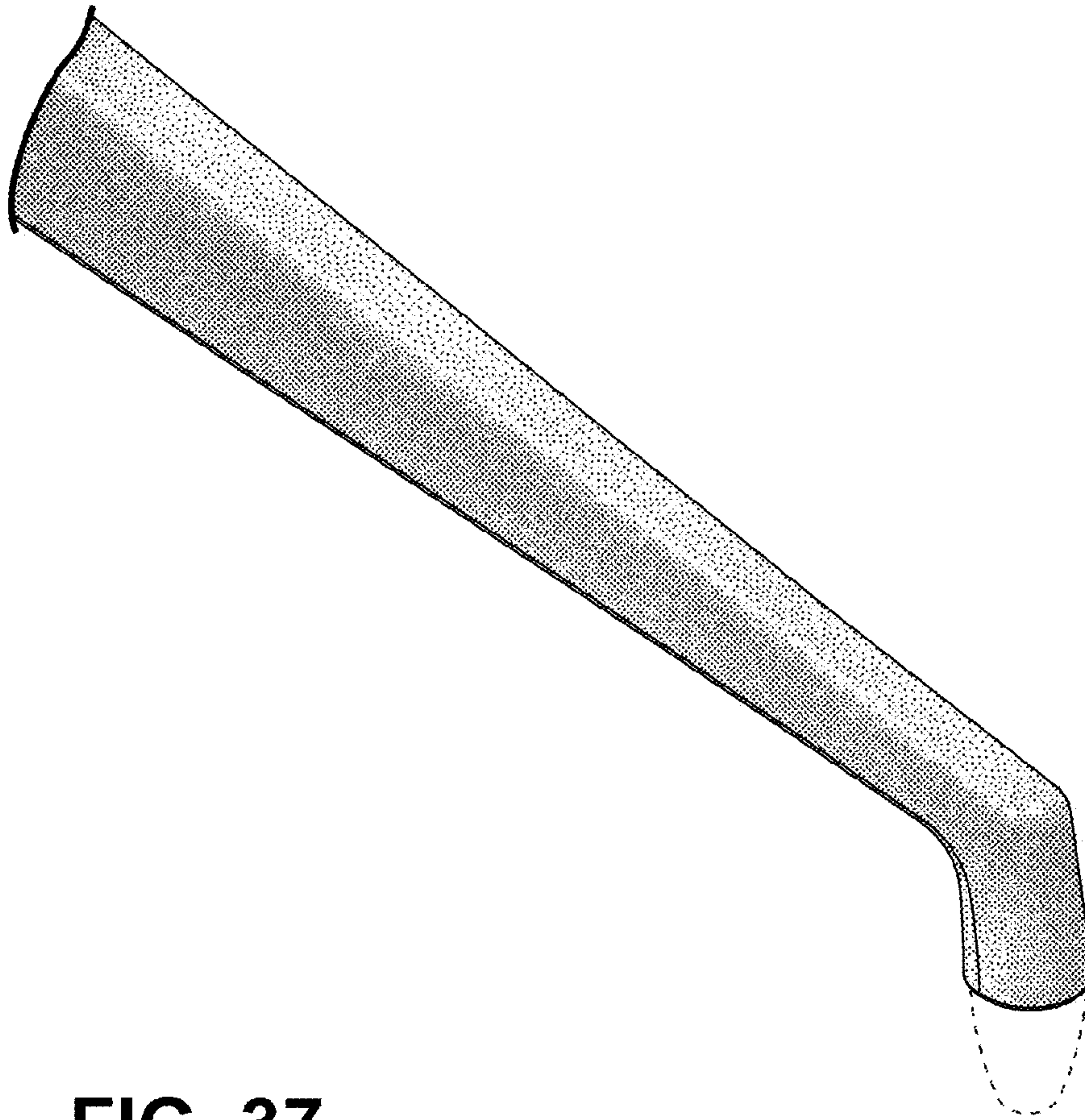

FIG. 37

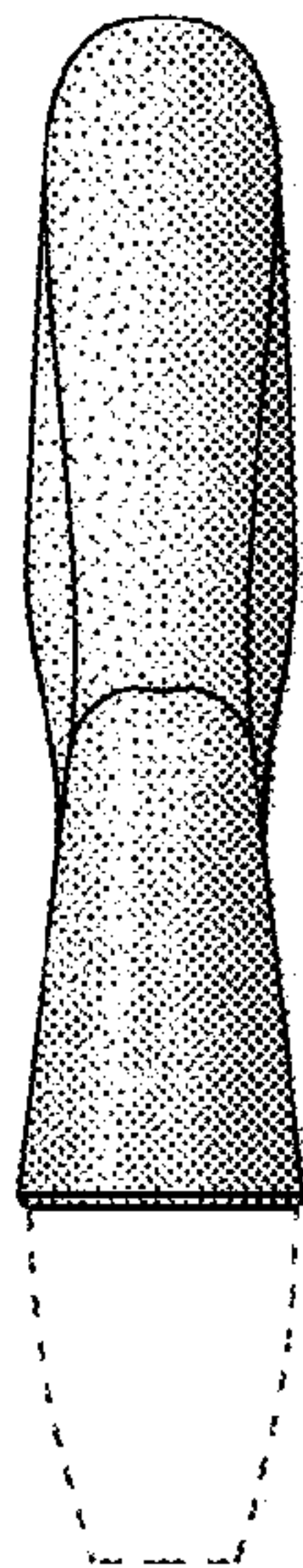

FIG. 38

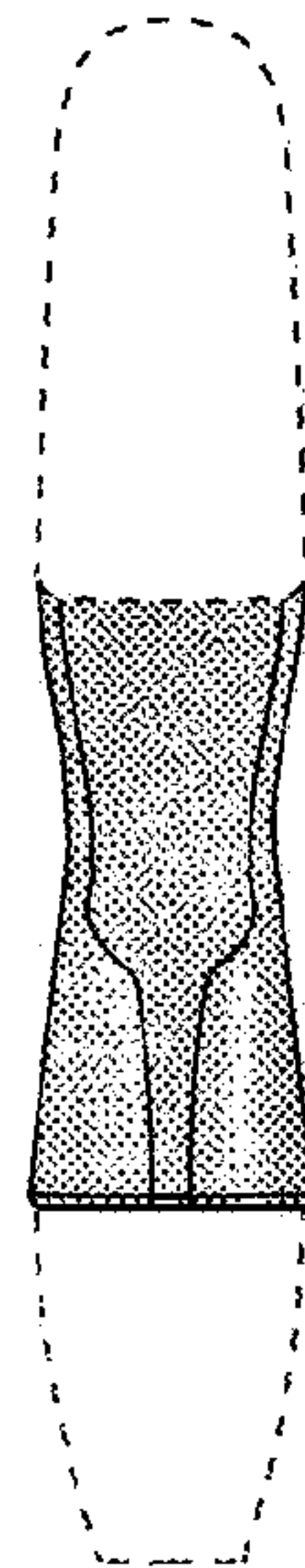

FIG. 39

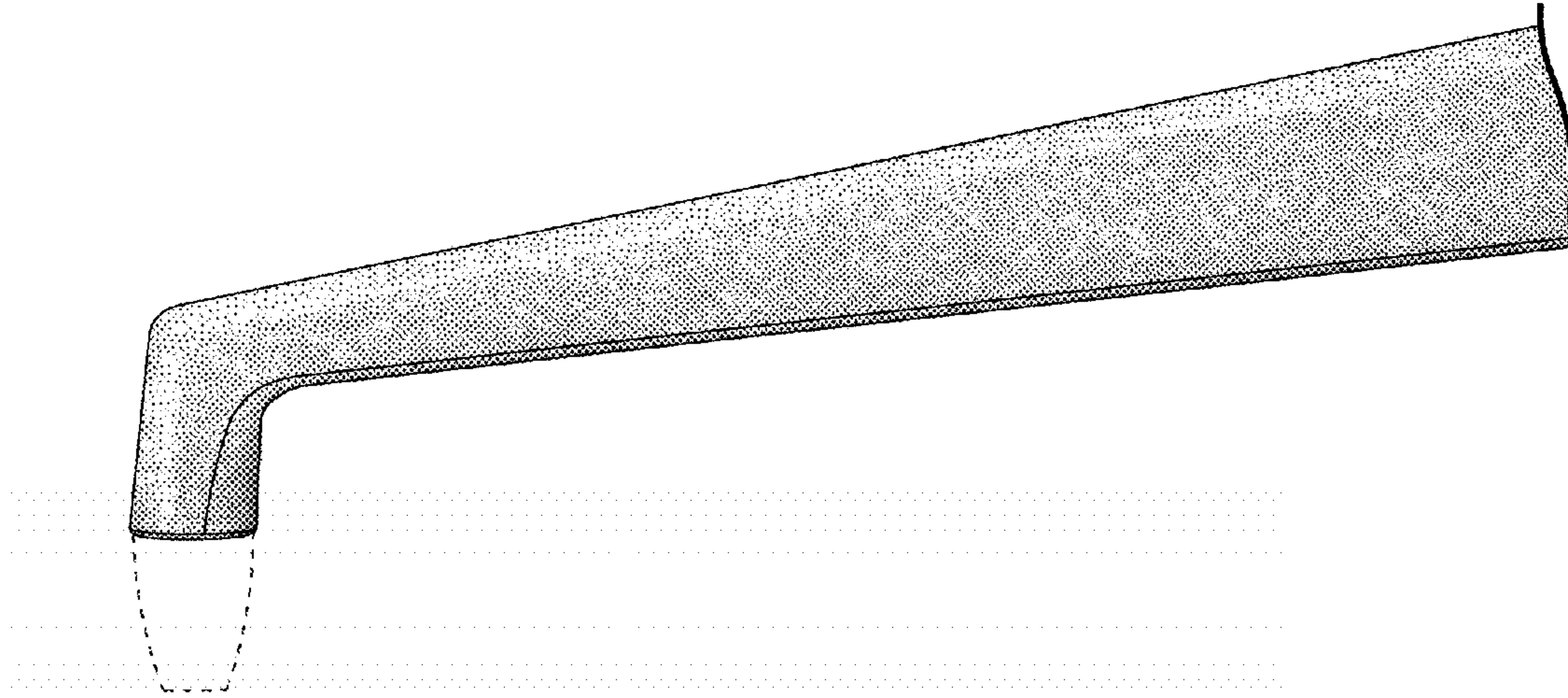

FIG. 40

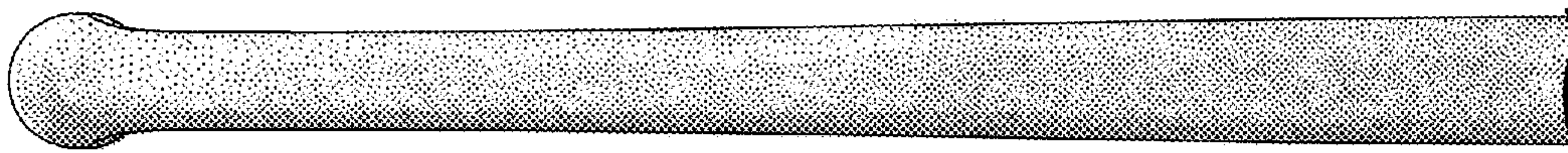

FIG. 41

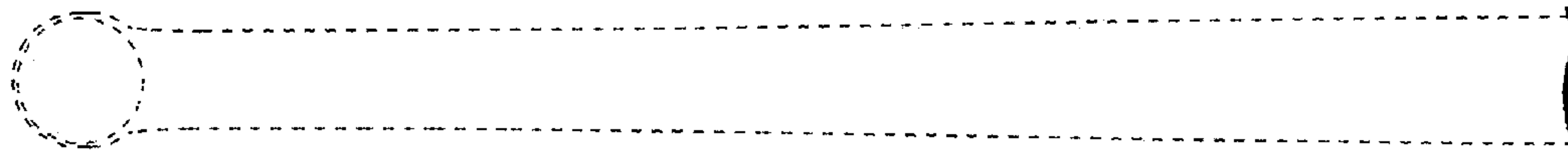

FIG. 42

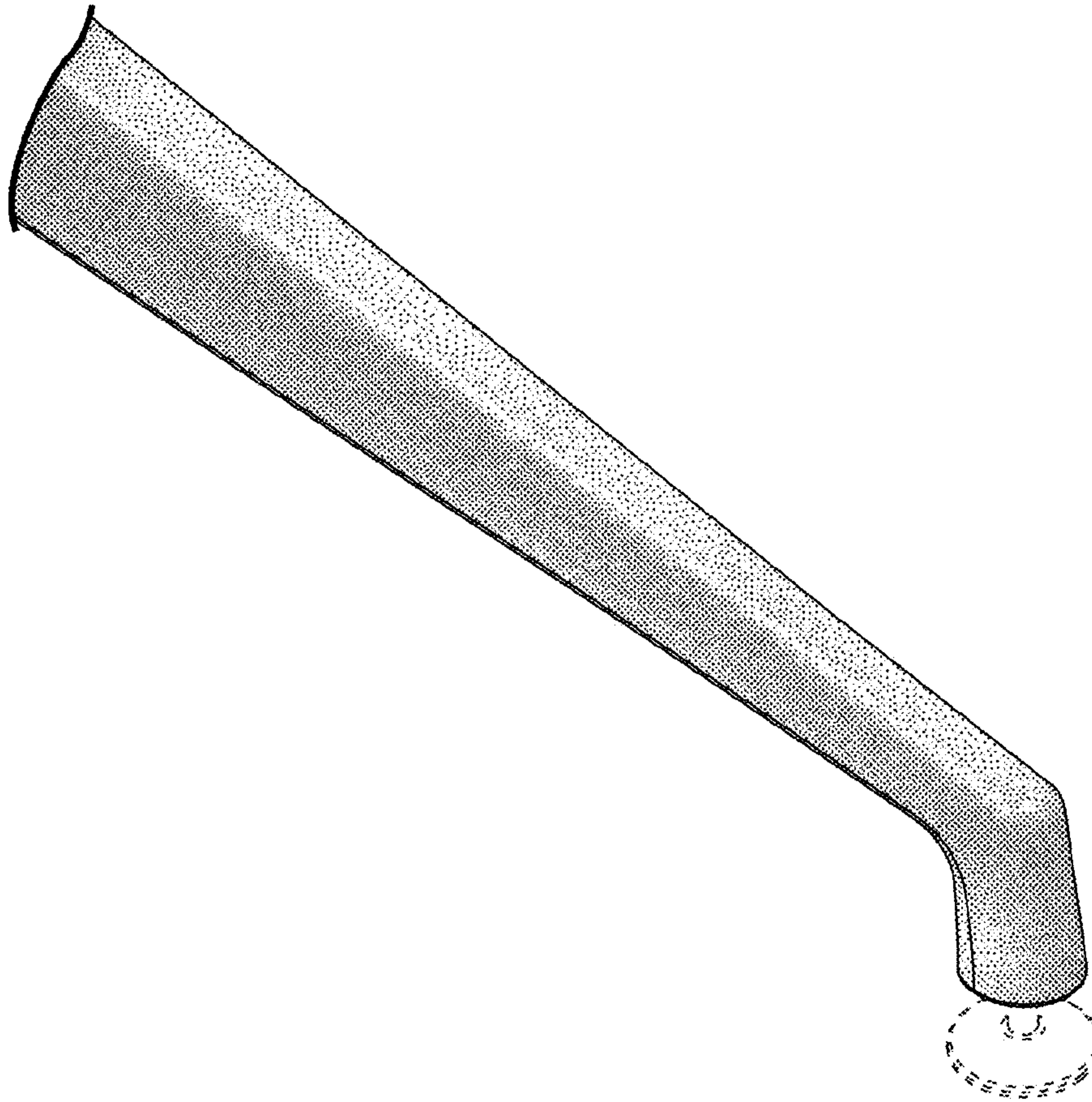

FIG. 43

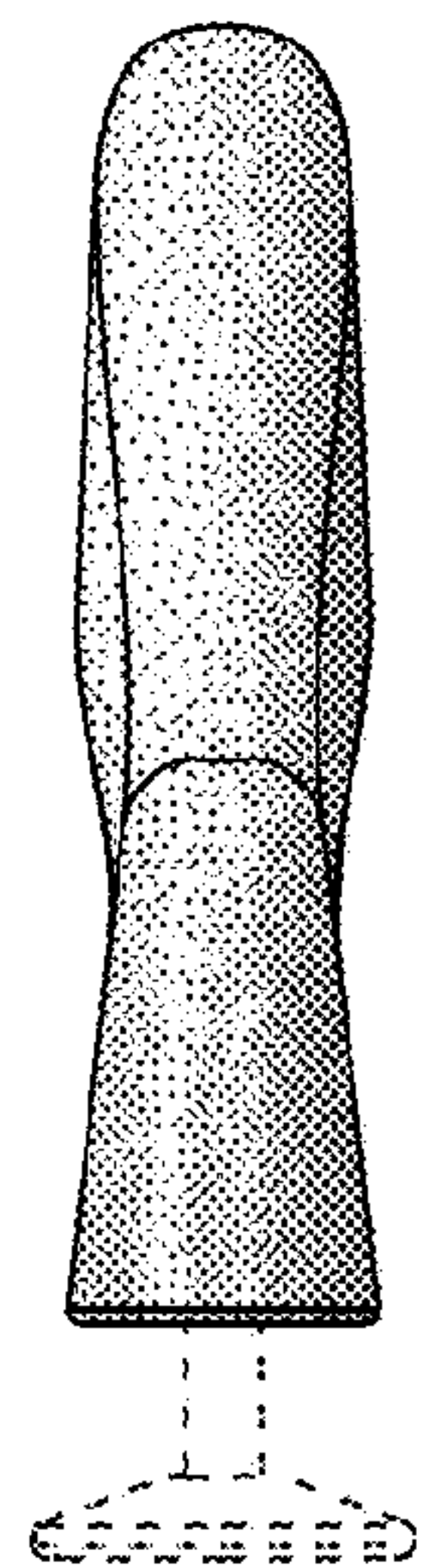

FIG. 44

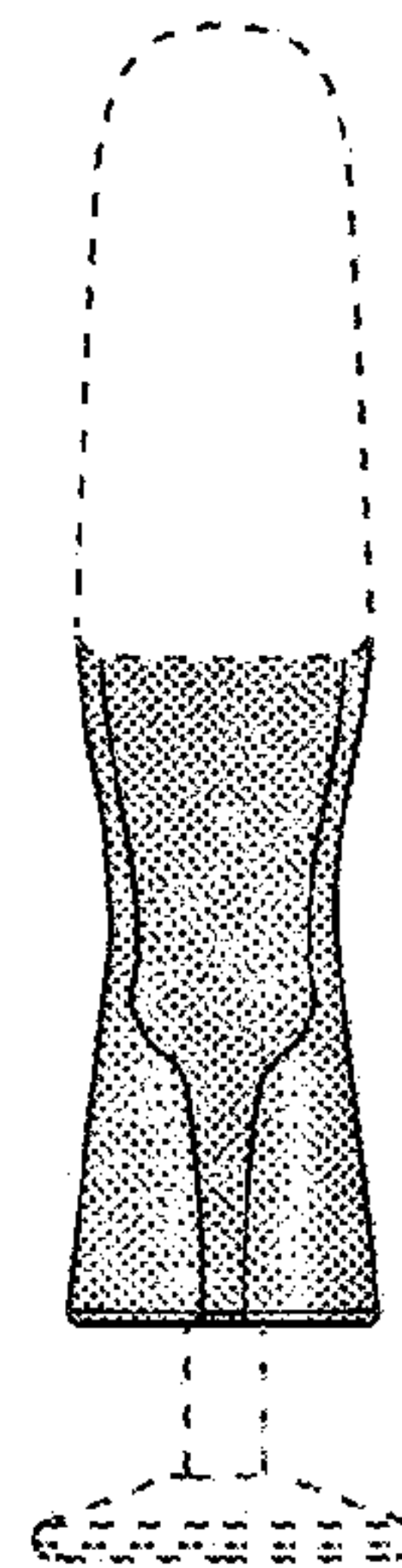

FIG. 45

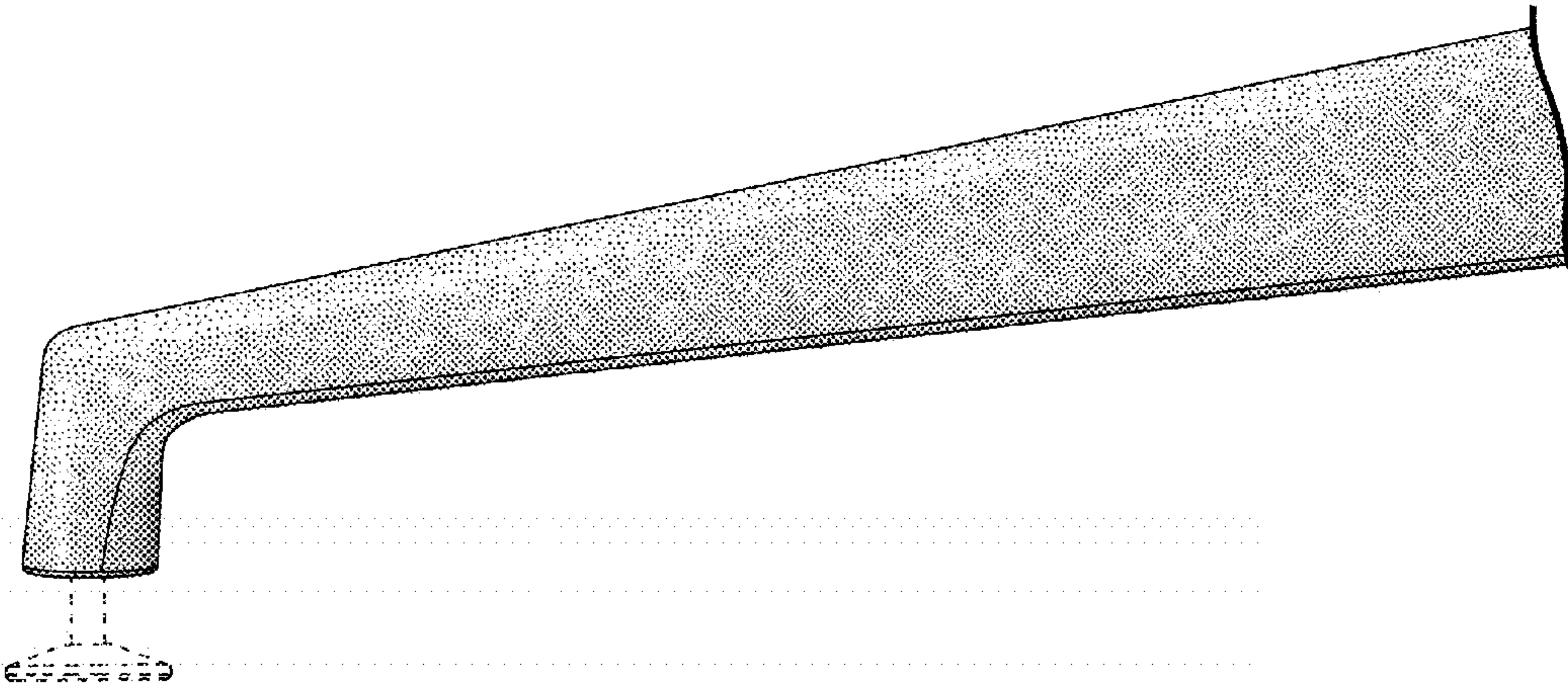

FIG. 46

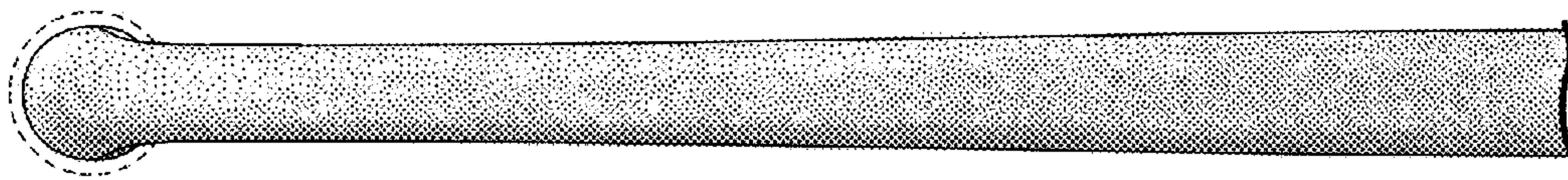

FIG. 47

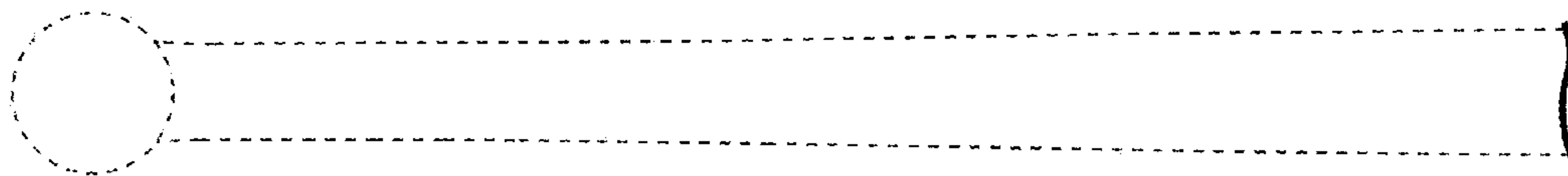

FIG. 48

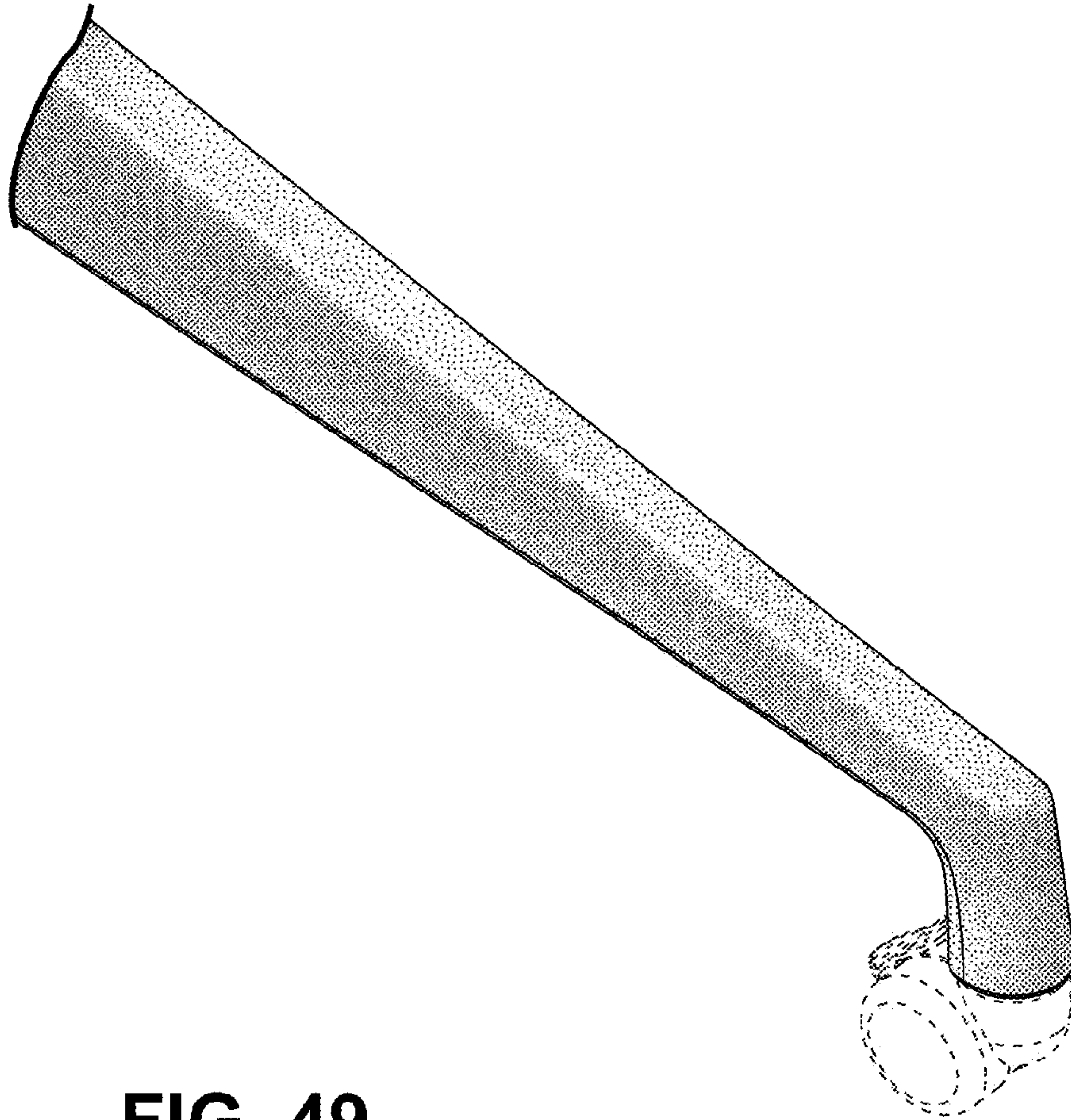

FIG. 49

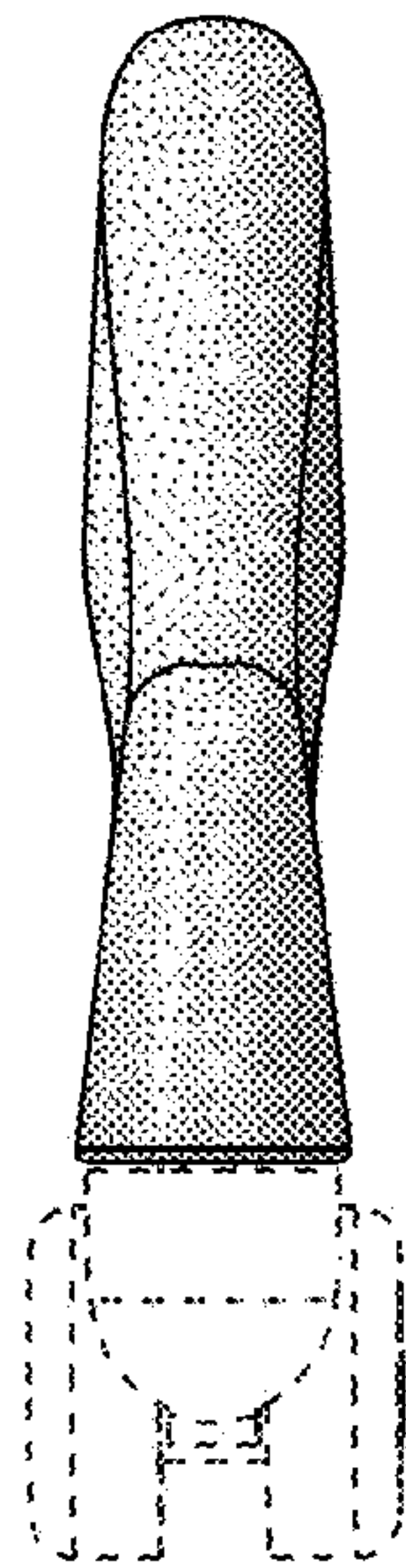

FIG. 50

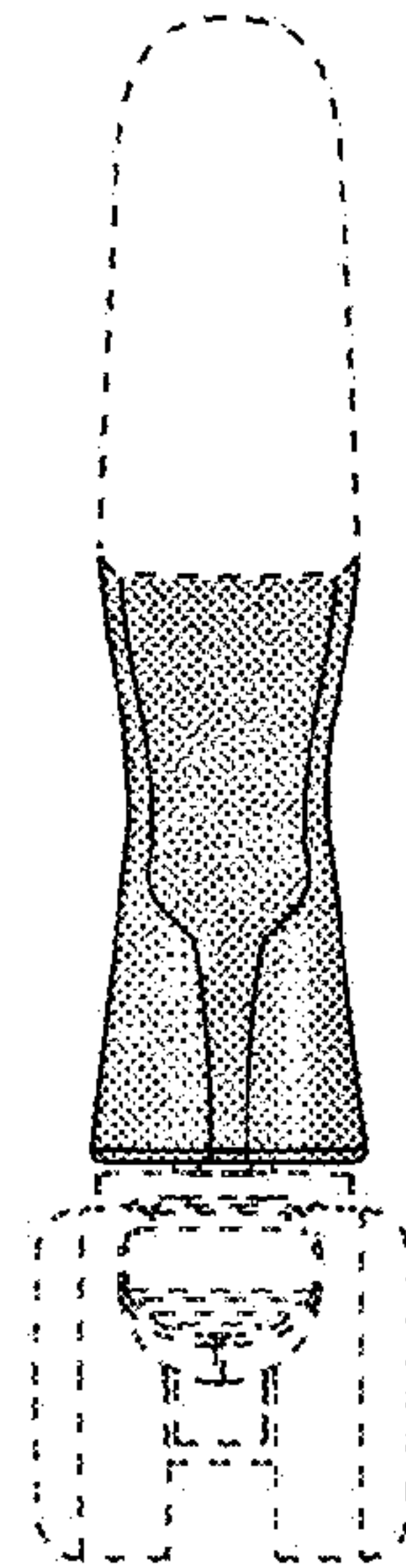

FIG. 51

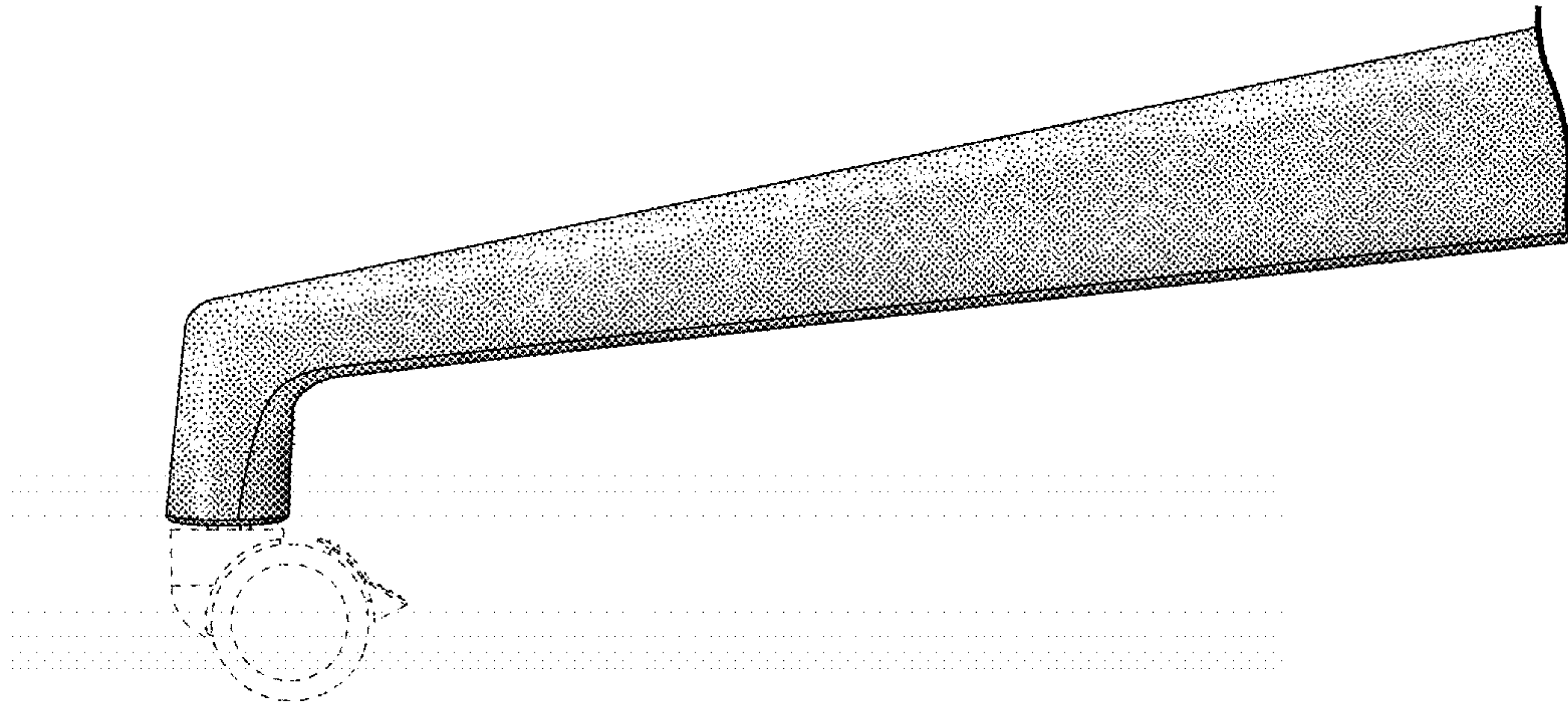

FIG. 52

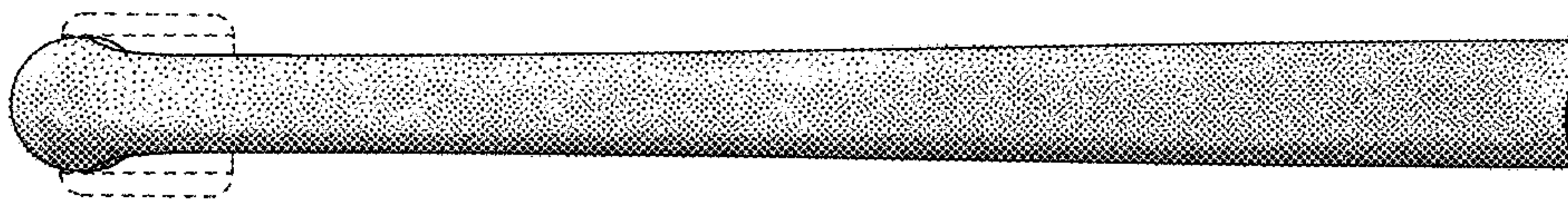

FIG. 53

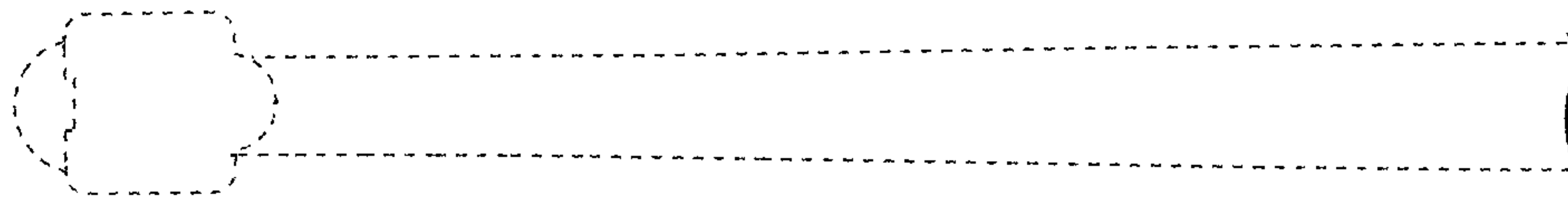

FIG. 54

UNITED STATES PATENT AND TRADEMARK OFFICE
CERTIFICATE OF CORRECTION

PATENT NO. : D775,488 S
APPLICATION NO. : 29/494223
DATED : January 3, 2017
INVENTOR(S) : Paul Frederick Koning et al.

Page 1 of 1

It is certified that error appears in the above-identified patent and that said Letters Patent is hereby corrected as shown below:

In the Description:

“FIG. 37 is a perspective view of the first environment of our table leg design showing the design in an alternate embodiment;” should be read as “FIG. 37 is a perspective view of the first embodiment of our table leg design showing the design in an alternate embodiment”.

“FIG. 43 is a perspective view of the first environment of our table leg design showing the design in an alternate embodiment;” should be read as “FIG. 43 is a perspective view of the first embodiment of our table leg design showing the design in an alternate embodiment;”.

“FIG. 49 is a perspective view of the first environment of our table leg design showing the design in an alterante embodiment;” should be read as “FIG. 49 is a perspective view of the first embodiment of our table leg design showing the design in an alternate embodiment;”.

Signed and Sealed this
Eighteenth Day of April, 2017



Michelle K. Lee
Director of the United States Patent and Trademark Office