



US00D775467S

(12) **United States Design Patent**
Nilsson et al.

(10) **Patent No.:** **US D775,467 S**
(45) **Date of Patent:** **** Jan. 3, 2017**

(54) **STORAGE CONTAINER AND PORTION OF A RACK**

(71) Applicant: **Elfa International AB**, Västerrik (SE)

(72) Inventors: **Peter Nilsson**, Västerrik (SE); **Johan Andersson**, Västerrik (SE); **Fikret Arnautovic**, Västerrik (SE)

(73) Assignee: **Elfa International AB**, Vasterrik (SE)

(**) Term: **15 Years**

(21) Appl. No.: **29/530,252**

(22) Filed: **Jun. 15, 2015**

(30) **Foreign Application Priority Data**

Dec. 15, 2014 (EM) 002597476

(51) **LOC (10) Cl.** **03-01**

(52) **U.S. Cl.**
USPC **D3/306**

(58) **Field of Classification Search**
USPC D3/303-305, 306, 307-309; D19/75, 77,
D19/86, 90, 92, 100; D6/675, 675.5
(Continued)

(56) **References Cited**

U.S. PATENT DOCUMENTS

3,087,771 A 4/1963 Pari
3,484,035 A 12/1969 Swett et al.
(Continued)

FOREIGN PATENT DOCUMENTS

EP 0 176 904 A2 4/1986
GB 948898 A 11/1962
WO 2010/121295 A1 10/2010

Primary Examiner — Kelley Donnelly

(74) *Attorney, Agent, or Firm* — Thompson & Knight
LLP; Max Ciccarelli

(57) **CLAIM**

The ornamental design for a storage container and portion of a rack, as shown and described.

DESCRIPTION

FIG. 1 is a top perspective view of a first embodiment of a storage container and portion of a rack;
FIG. 2 is a front elevational view of the storage container and portion of a rack of FIG. 1;
FIG. 3 is a top plan view of the storage container and portion of a rack of FIG. 1;
FIG. 4 is a bottom plan view of the storage container and portion of a rack of FIG. 1;
FIG. 5 is a rear elevational view of the storage container and portion of a rack of FIG. 1;
FIG. 6 is an elevational view of a first end of the storage container and portion of a rack of FIG. 1;
FIG. 7 is an elevational view of a second end of the storage container and portion of a rack of FIG. 1;
FIG. 8 is a top perspective view of a second embodiment of a storage container and portion of a rack;
FIG. 9 is a front elevational view of the storage container and portion of a rack of FIG. 8;
FIG. 10 is a top plan view of the storage container and portion of a rack of FIG. 8;
FIG. 11 is a bottom plan view of the storage container and portion of a rack of FIG. 8;
FIG. 12 is rear elevational view of the storage container and portion of rack of FIG. 8;
FIG. 13 is an elevational view of a first end of the storage container and portion of a rack of FIG. 8;
FIG. 14 is an elevational view of a second end of the storage container and portion of a rack of FIG. 8;
FIG. 15 is a top perspective view of a third embodiment of a storage container and portion of a rack;
FIG. 16 is a front elevational view of the storage container and portion of a rack of FIG. 15;
FIG. 17 is a top plan view of the storage container and portion of a rack of FIG. 15;
FIG. 18 is a bottom plan view of the storage container and portion of a rack of FIG. 15;
FIG. 19 is a rear elevational view of the storage container and portion of a rack of FIG. 15;

(Continued)

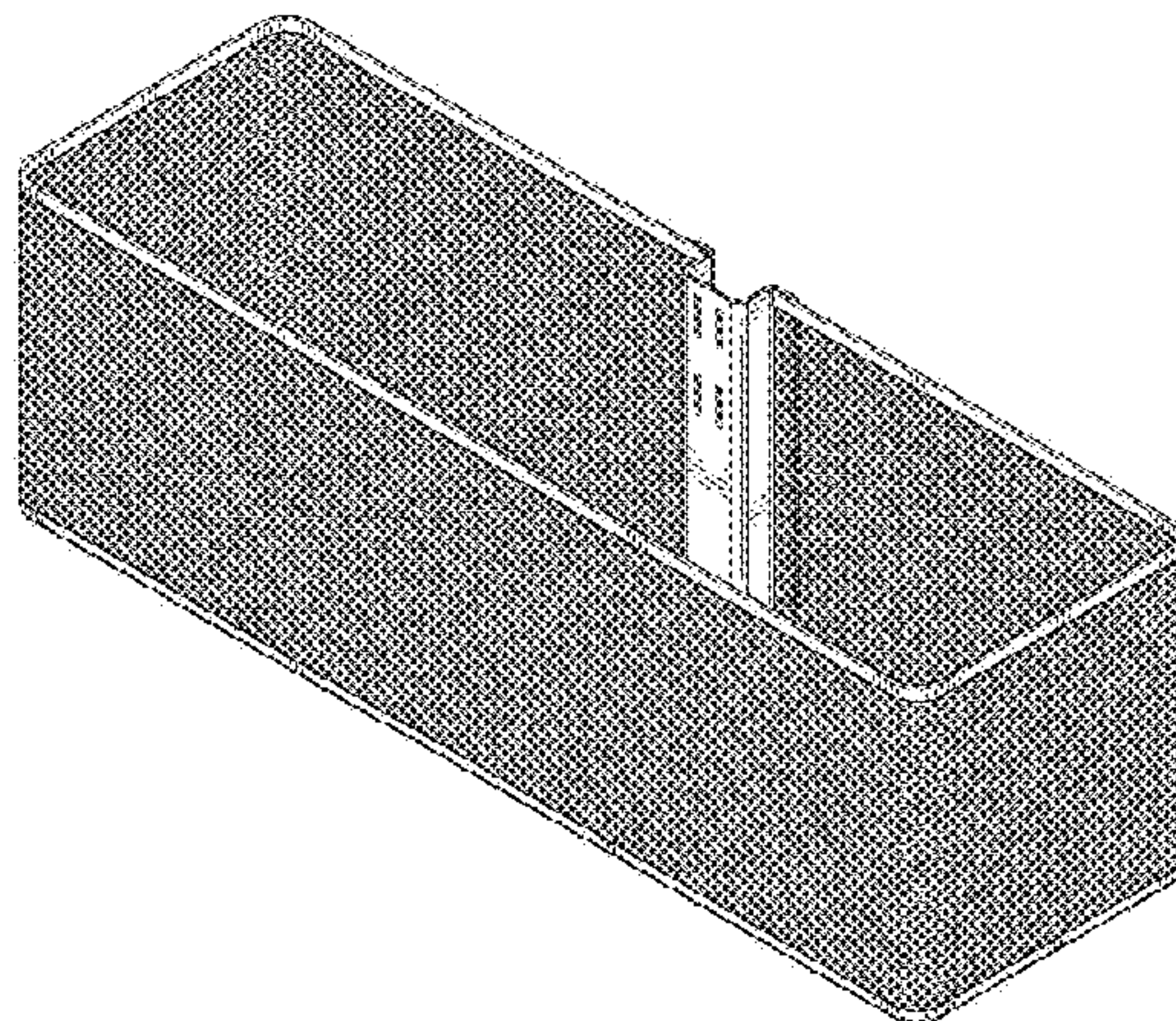

FIG. 20 is an elevational view of a first end of the storage container and portion of a rack of FIG. 15; and, FIG. 21 is an elevational view of a second end of the storage container and portion of a rack of FIG. 15. The broken lines shown in the drawings indicate an exemplary environment in which the portion of a rack is intended to be used and form no part of the design to be patented.

1 Claim, 14 Drawing Sheets

(58) **Field of Classification Search**

CPC B65D 81/3813; B65D 21/00; B65D 1/02
See application file for complete search history.

(56) **References Cited**

U.S. PATENT DOCUMENTS

4,795,041	A	1/1989	Remmers	
D419,302	S	1/2000	Hardy et al.	
D431,907	S	10/2000	Andujar et al.	
D433,709	S *	11/2000	Hardy	D19/75
D449,074	S	10/2001	Andujar	
D450,481	S	11/2001	Post	
D451,675	S	12/2001	Hardy et al.	
D453,027	S	1/2002	Andujar	
D476,155	S	6/2003	Post et al.	
D481,233	S	10/2003	Post et al.	
D486,981	S	2/2004	Post et al.	
D488,334	S	4/2004	Post et al.	

6,718,635	B2	4/2004	Cheng et al.	
D498,375	S *	11/2004	Post	D3/306
D501,105	S	1/2005	Post et al.	
D503,059	S	3/2005	Post et al.	
D513,874	S	1/2006	Hardy et al.	
D516,347	S	3/2006	Post et al.	
D516,814	S	3/2006	Post et al.	
D518,551	S *	4/2006	Moren	D22/136
D528,300	S *	9/2006	Hardy	D3/306
D530,517	S	10/2006	Hardy et al.	
7,270,245	B2	9/2007	Cheng et al.	
D554,896	S	11/2007	Post	
D563,163	S *	3/2008	Blouw	D7/409
D565,334	S	4/2008	Post et al.	
D567,553	S	4/2008	Post et al.	
D579,660	S *	11/2008	Snider	D3/304
D582,161	S *	12/2008	Hardy	D3/306
D584,055	S	1/2009	Hardy et al.	
D632,080	S	2/2011	Hardy et al.	
D639,561	S *	6/2011	Hardy	D3/306
D653,063	S	1/2012	Post et al.	
D657,563	S *	4/2012	Hardy	D3/306
D689,941	S *	9/2013	Hu	D19/77
D696,049	S *	12/2013	Hsu	D6/675.2
D730,128	S *	5/2015	Hu	D7/637
D731,256	S *	6/2015	Hu	D7/637
D736,014	S *	8/2015	Tsai	D6/675.2
D747,102	S *	1/2016	Kraemer	D3/307
2003/0102315	A1	6/2003	Cheng et al.	
2005/0077299	A1	4/2005	Cheng et al.	
2007/0187277	A1	8/2007	Furlong	
2012/0168433	A1	7/2012	Cheng et al.	
2014/0042113	A1	2/2014	Cheng et al.	

* cited by examiner

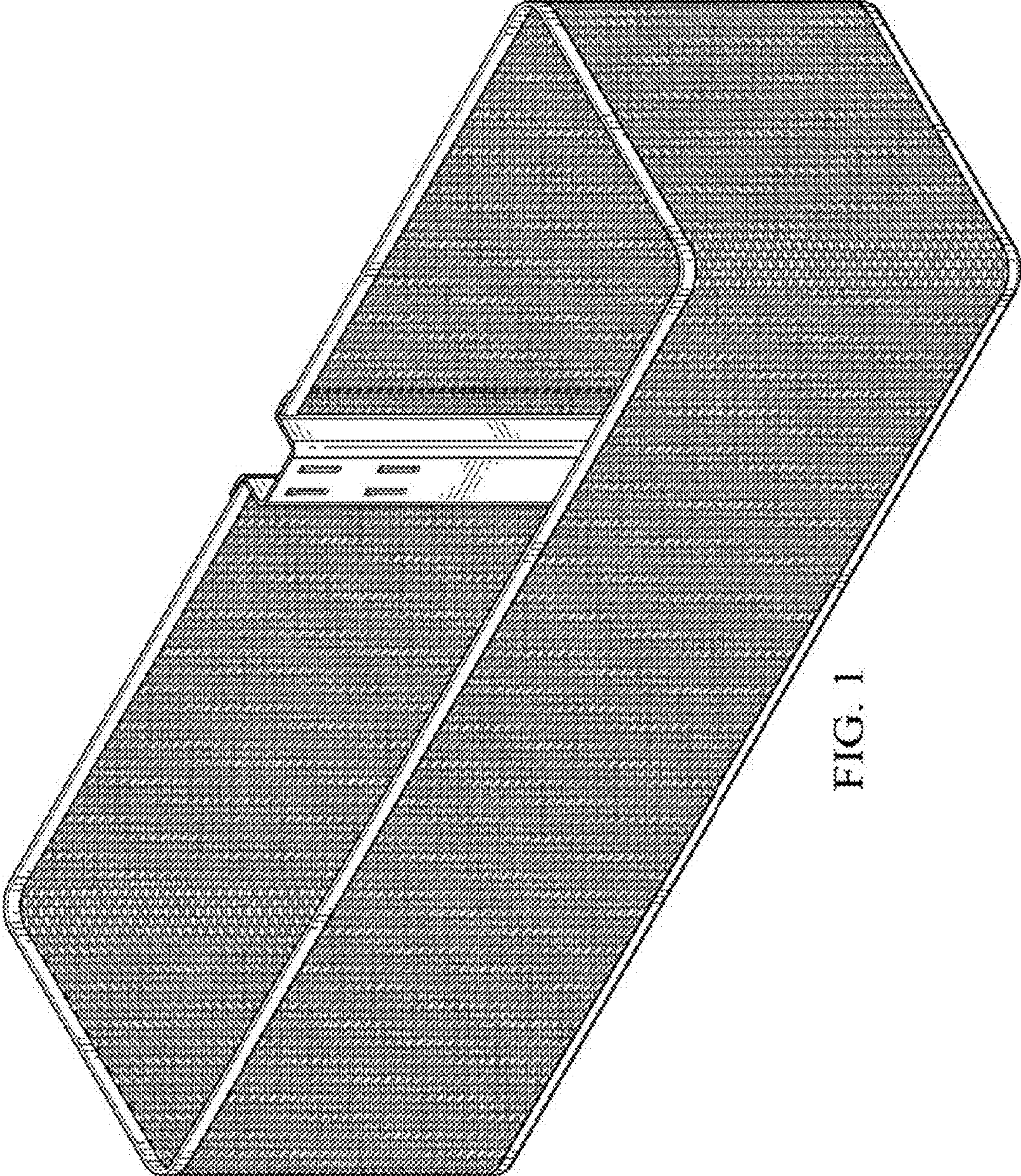

FIG. 1

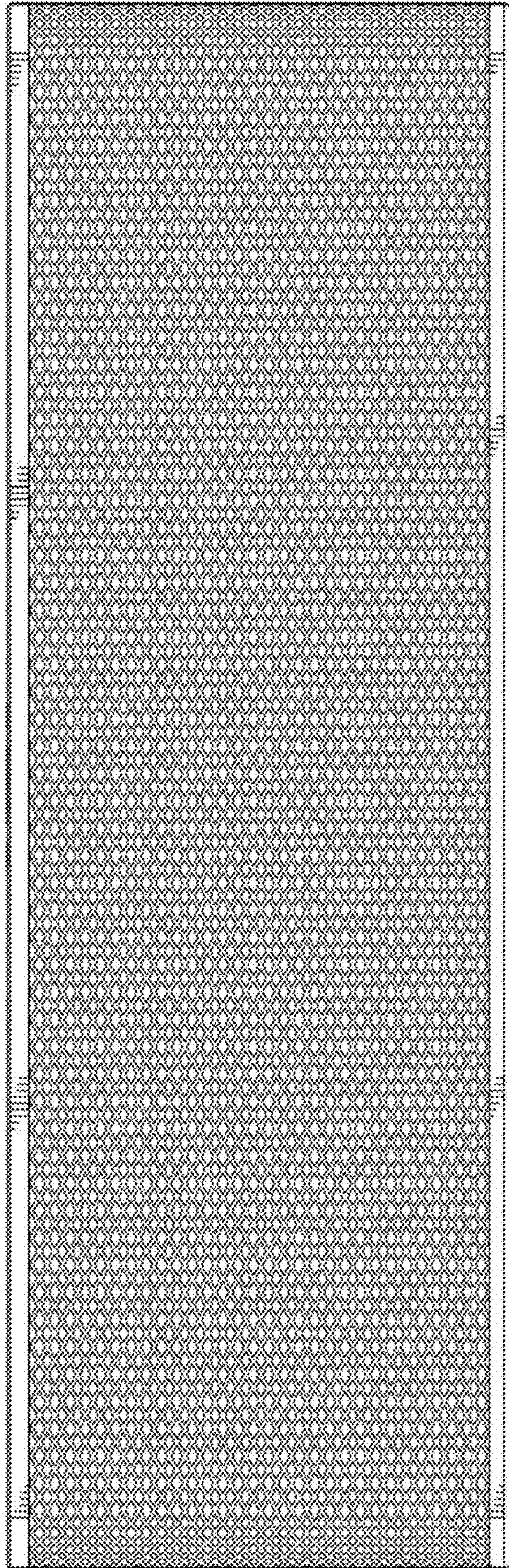

FIG. 2

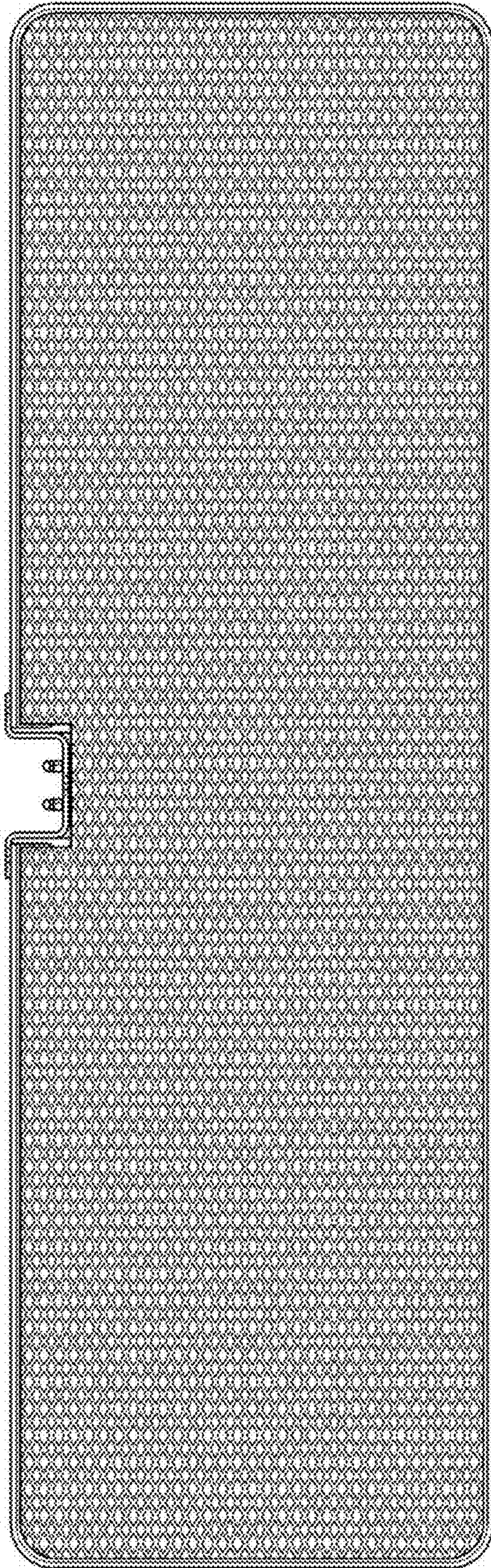

FIG. 3

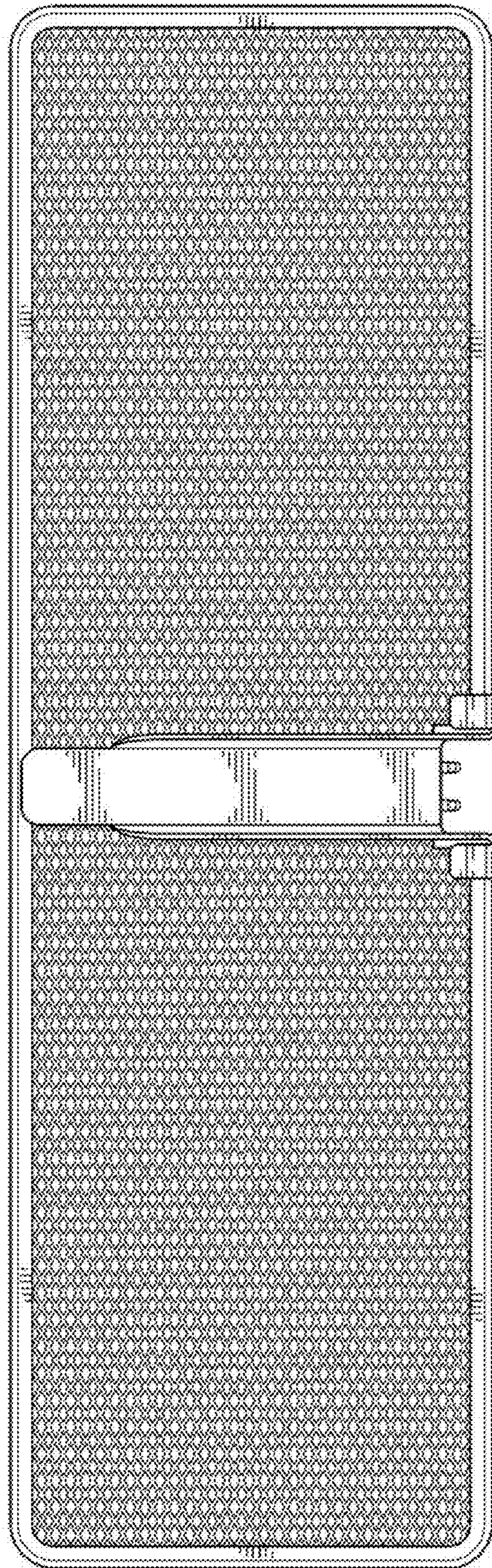

FIG. 4

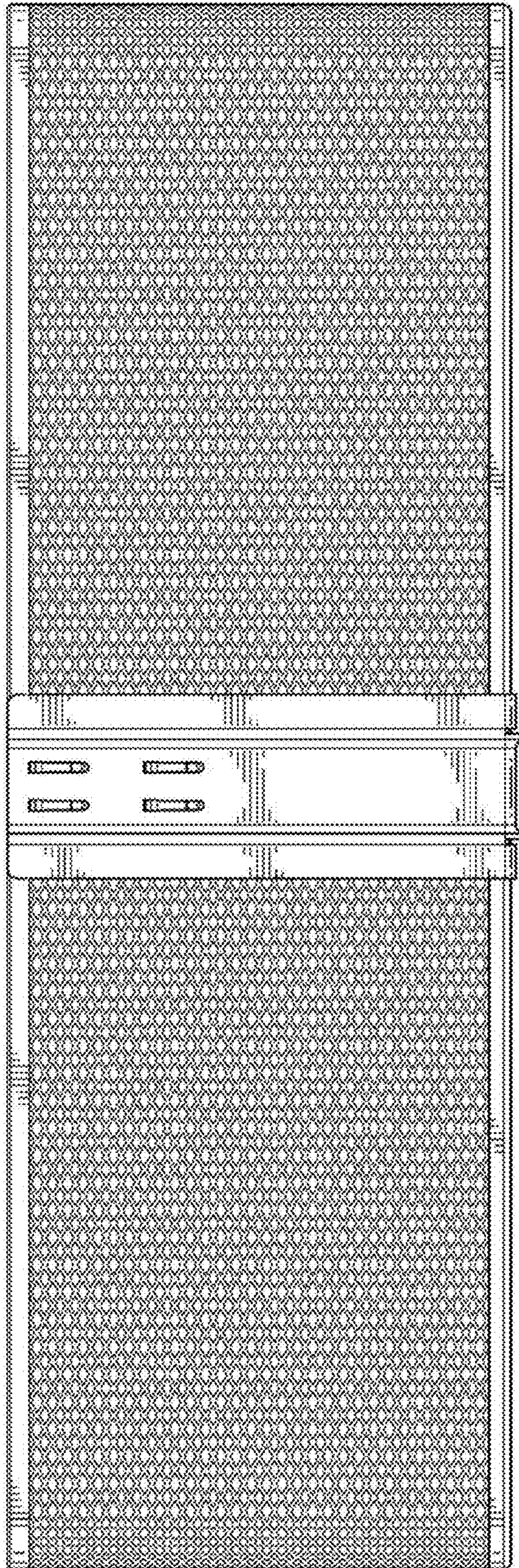

FIG. 5

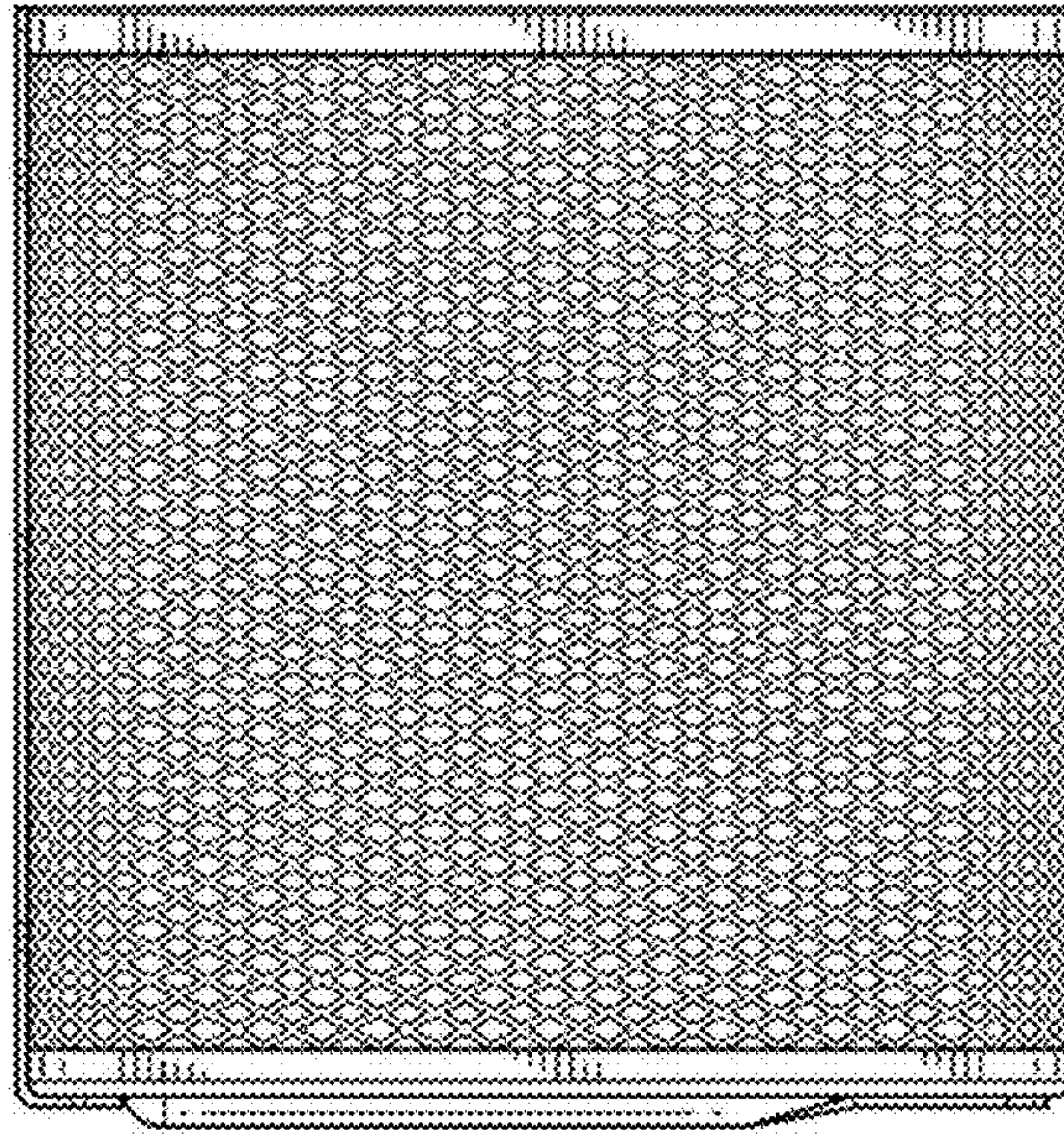

FIG. 6

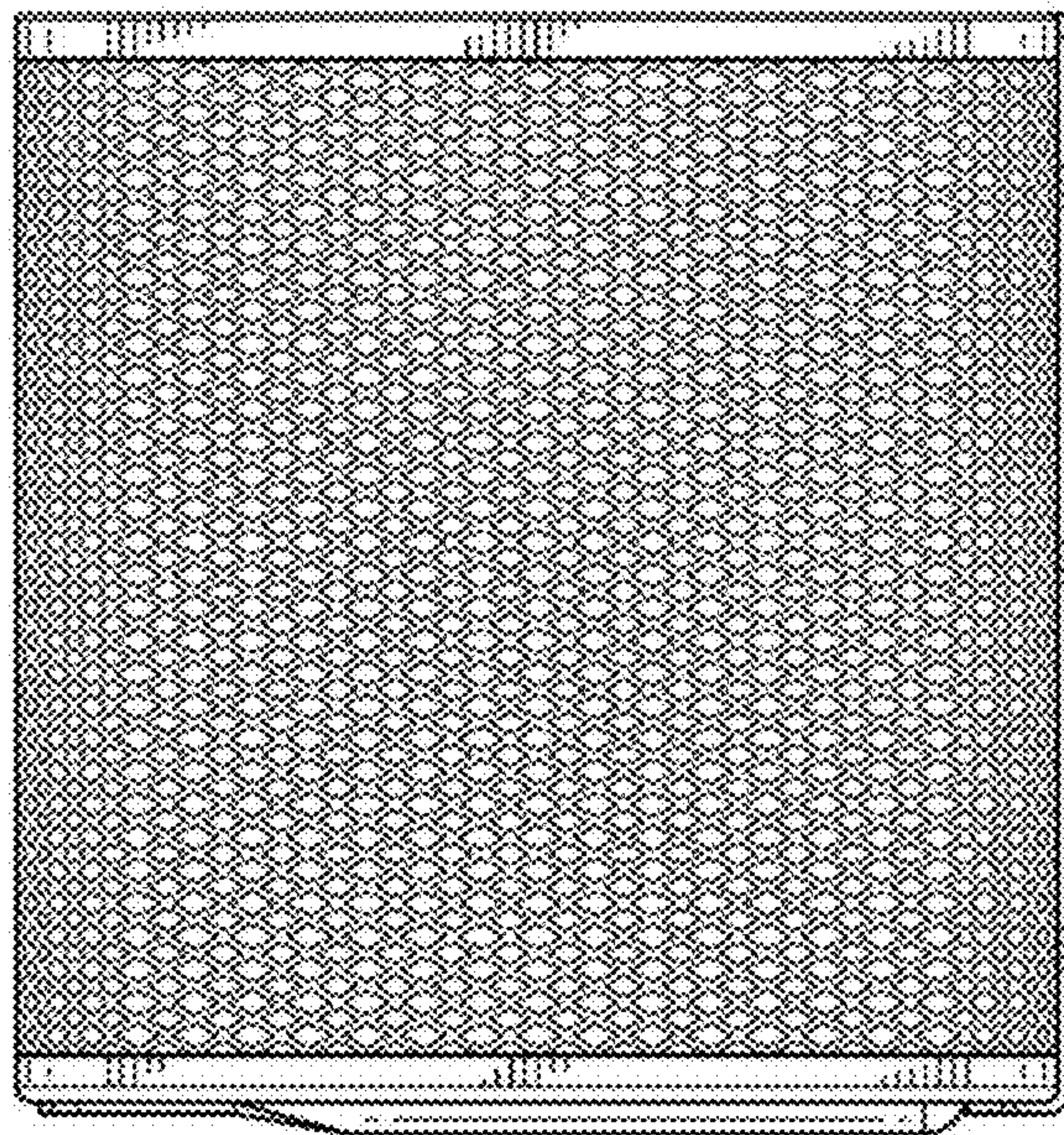

FIG. 7

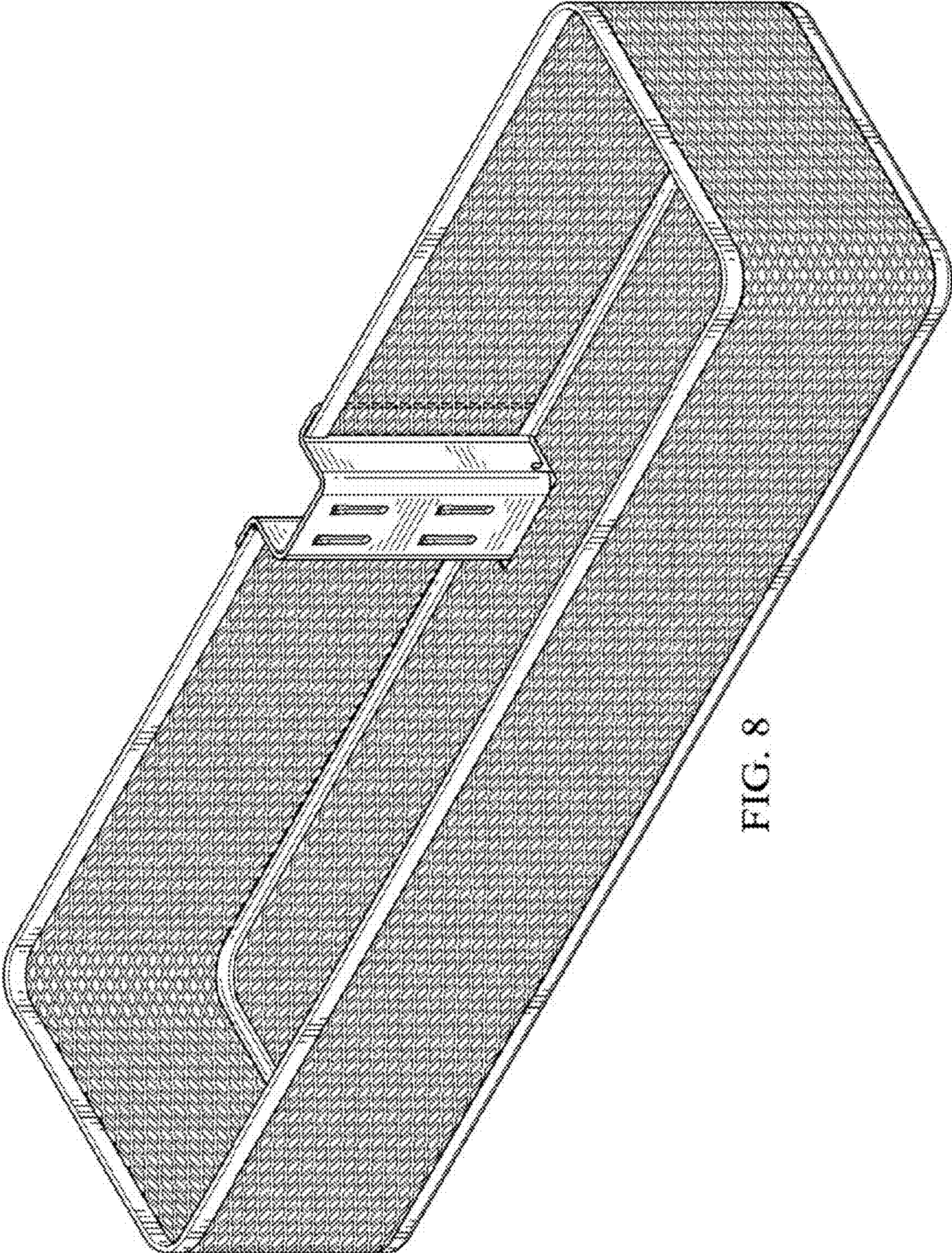

FIG. 8

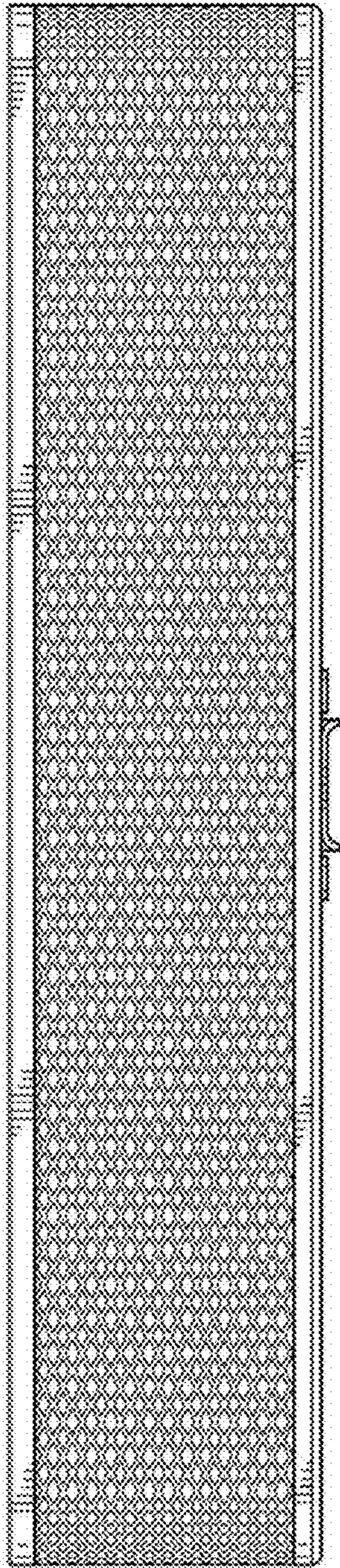

FIG. 9

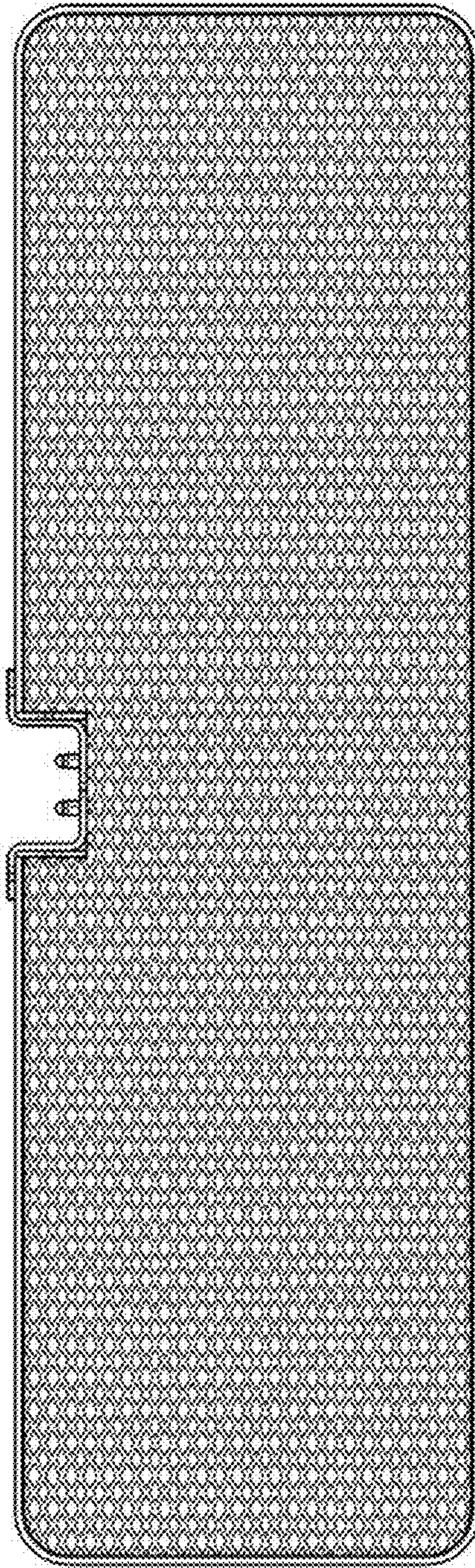

FIG. 10

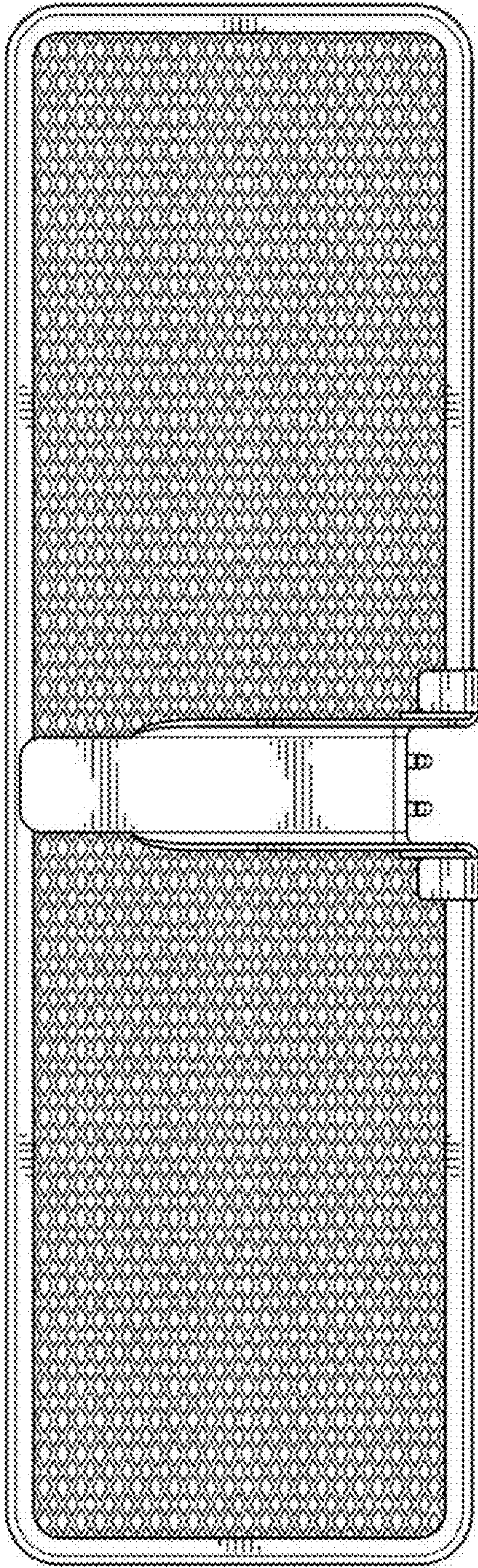

FIG. 11

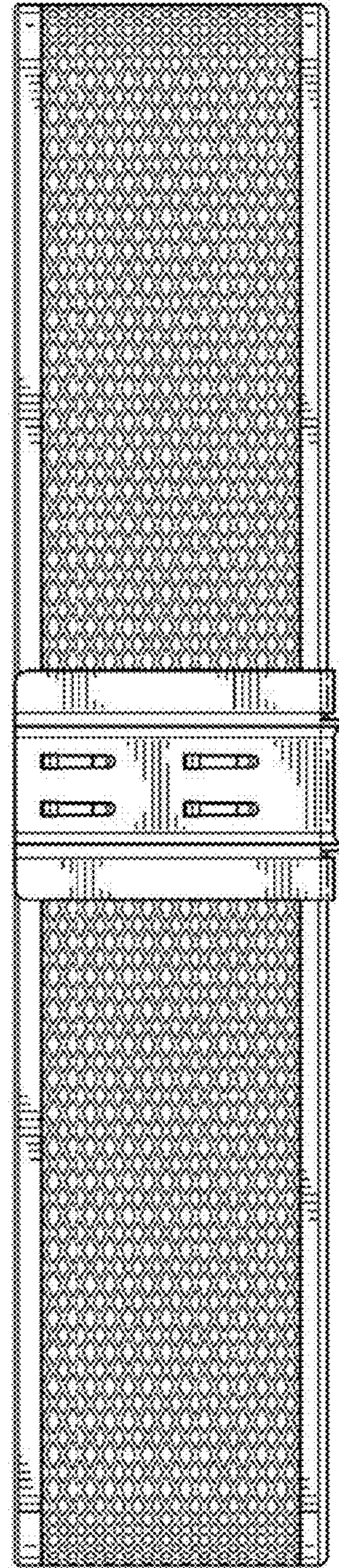

FIG. 12

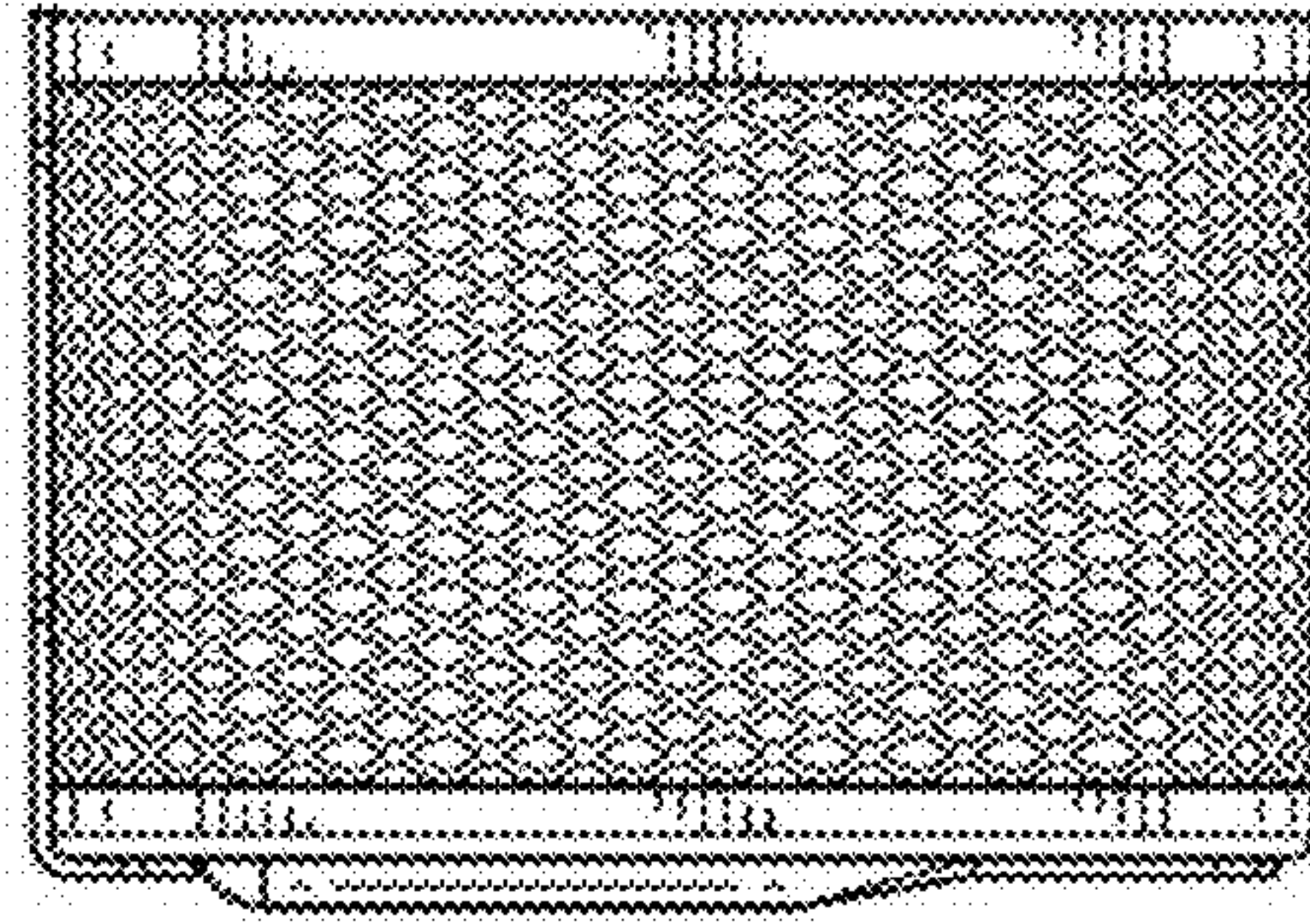

FIG. 13

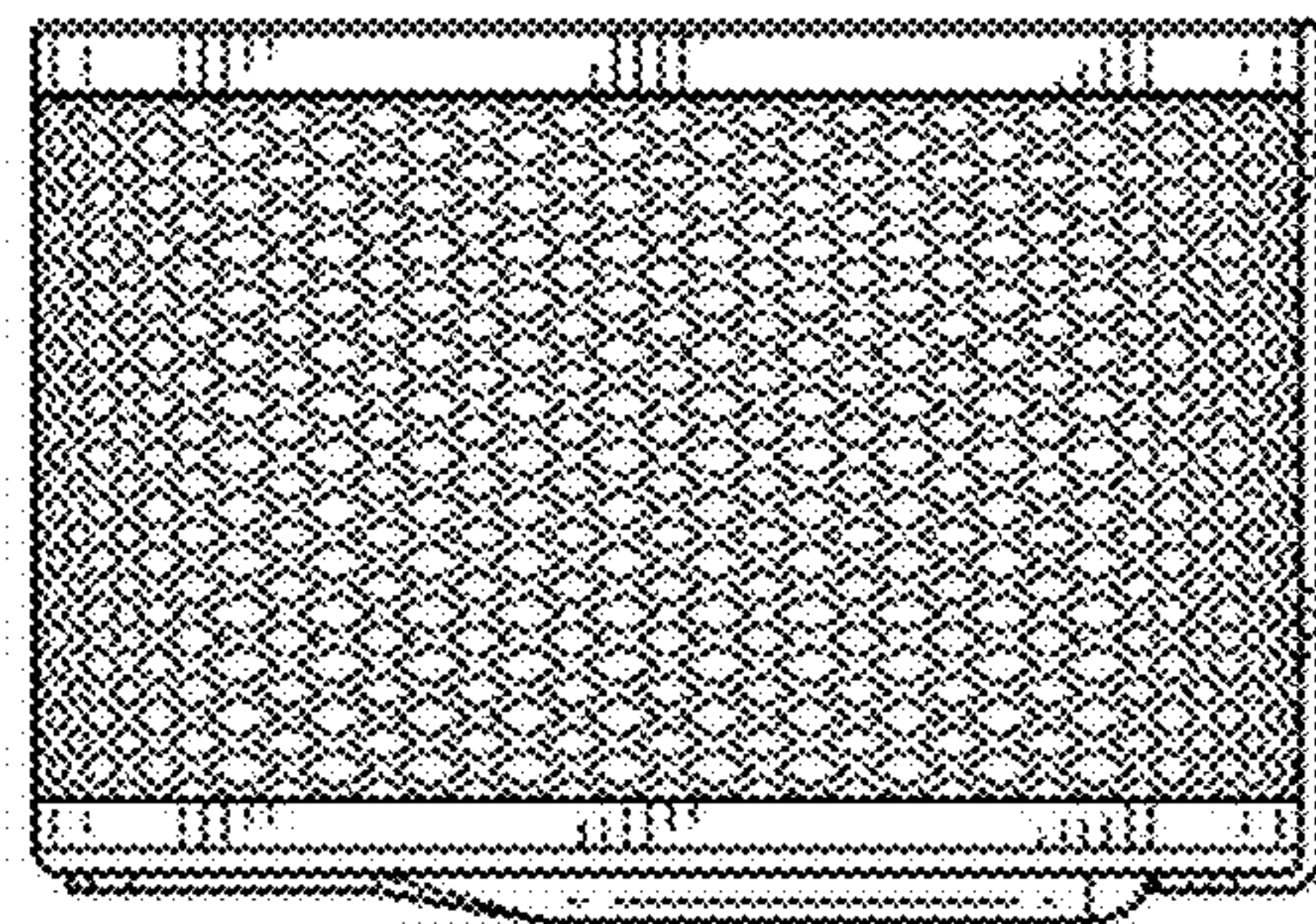

FIG. 14

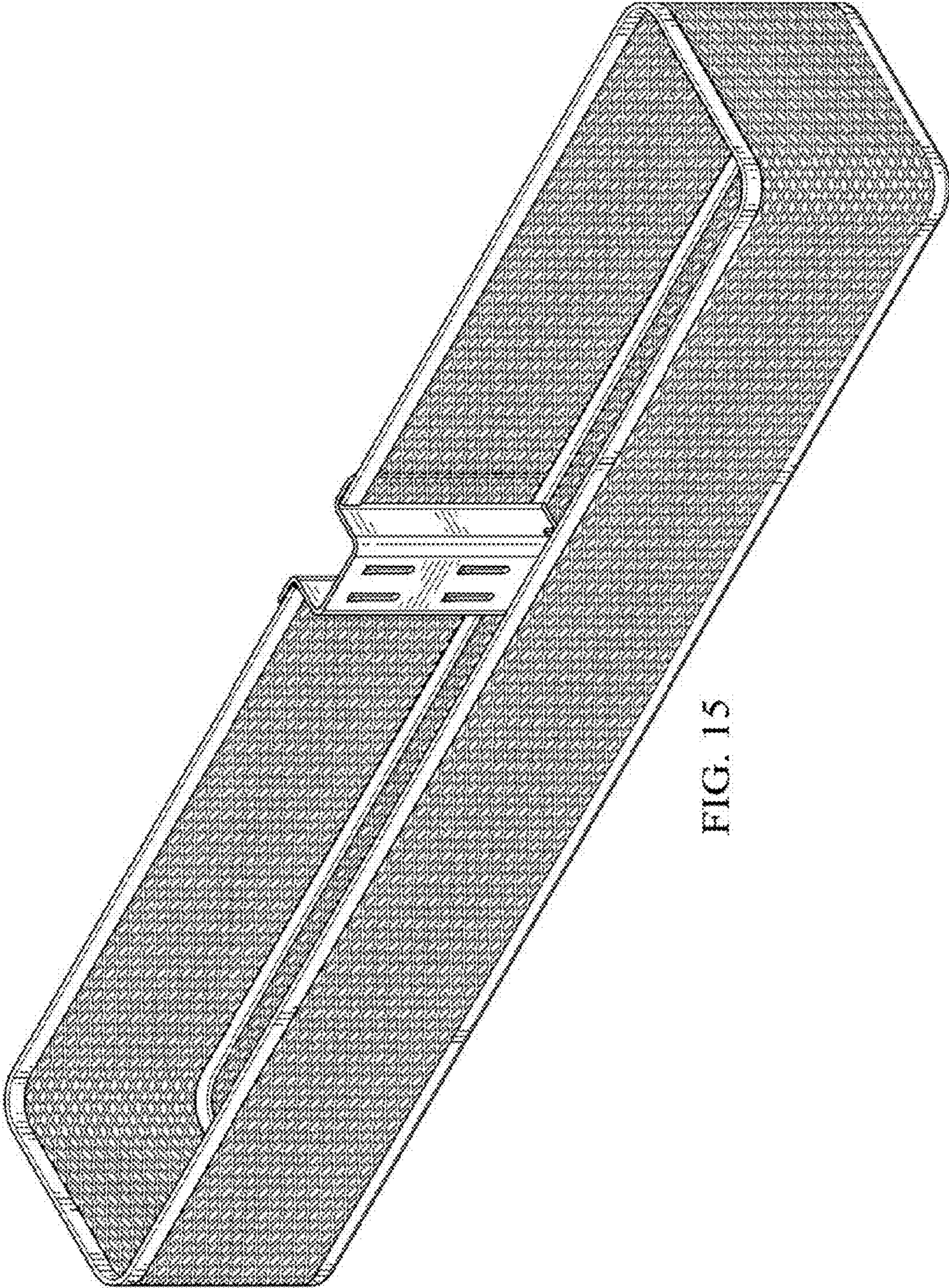

FIG. 15

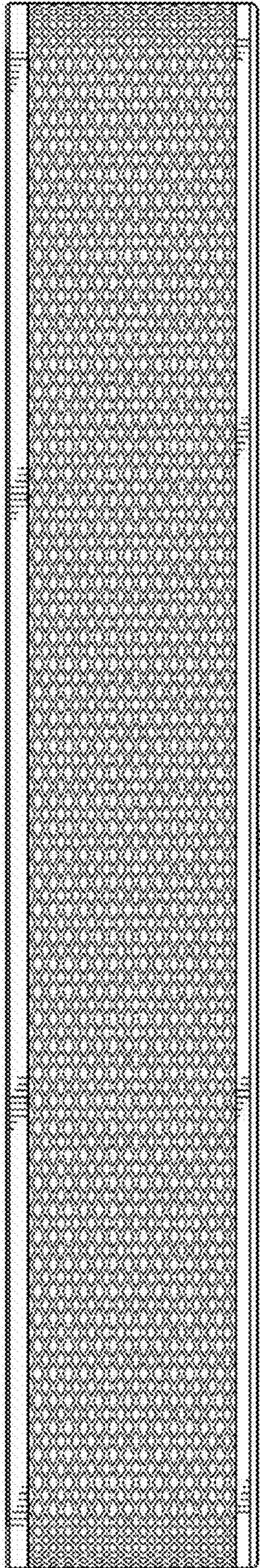

FIG. 16

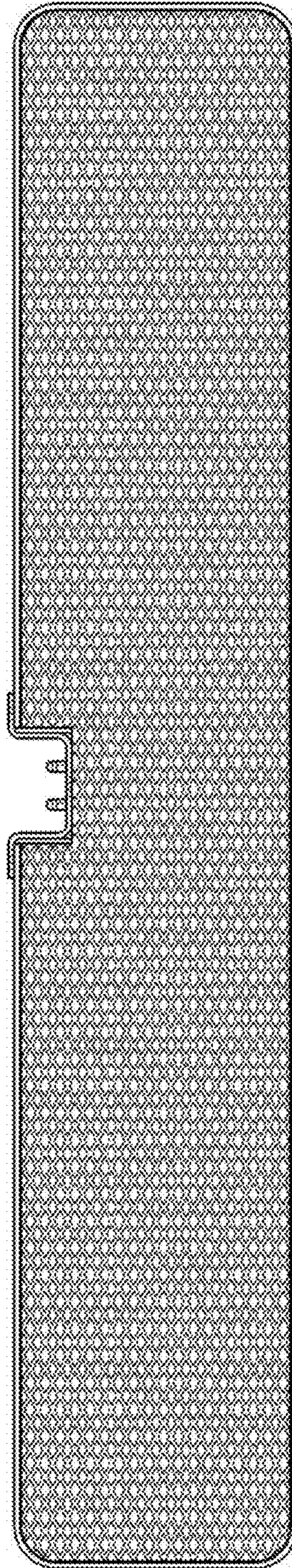

FIG. 17

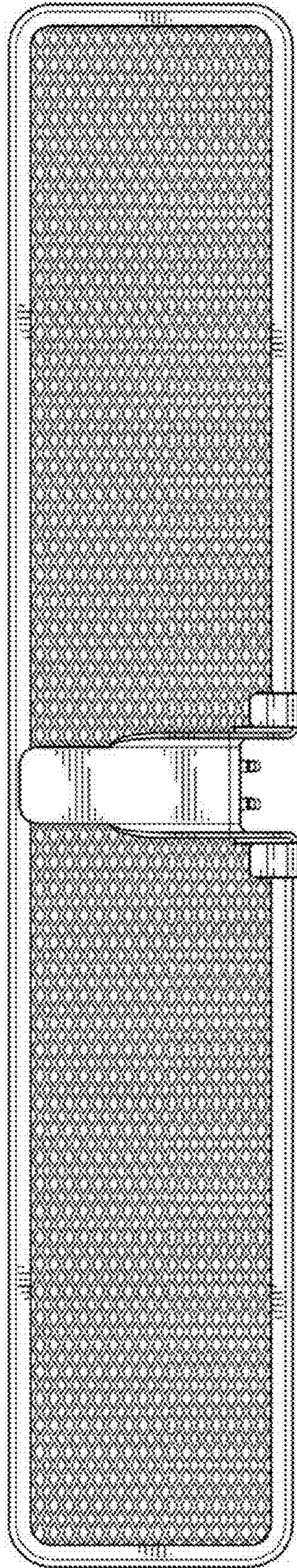

FIG. 18

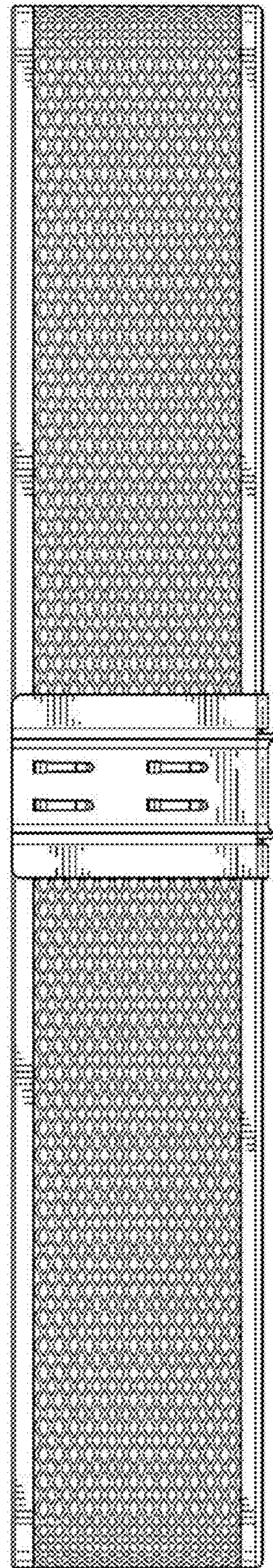

FIG. 19

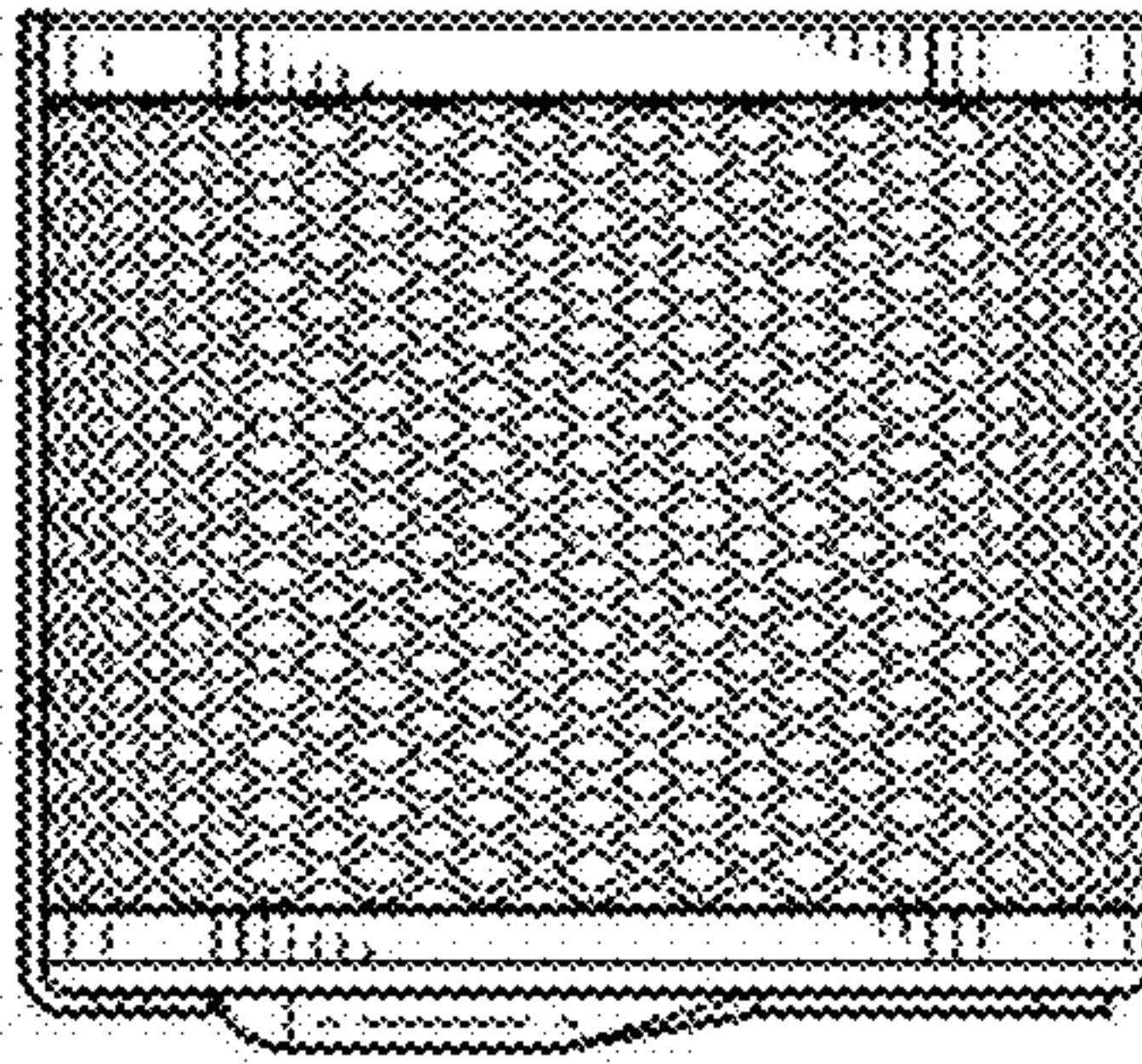

FIG. 20

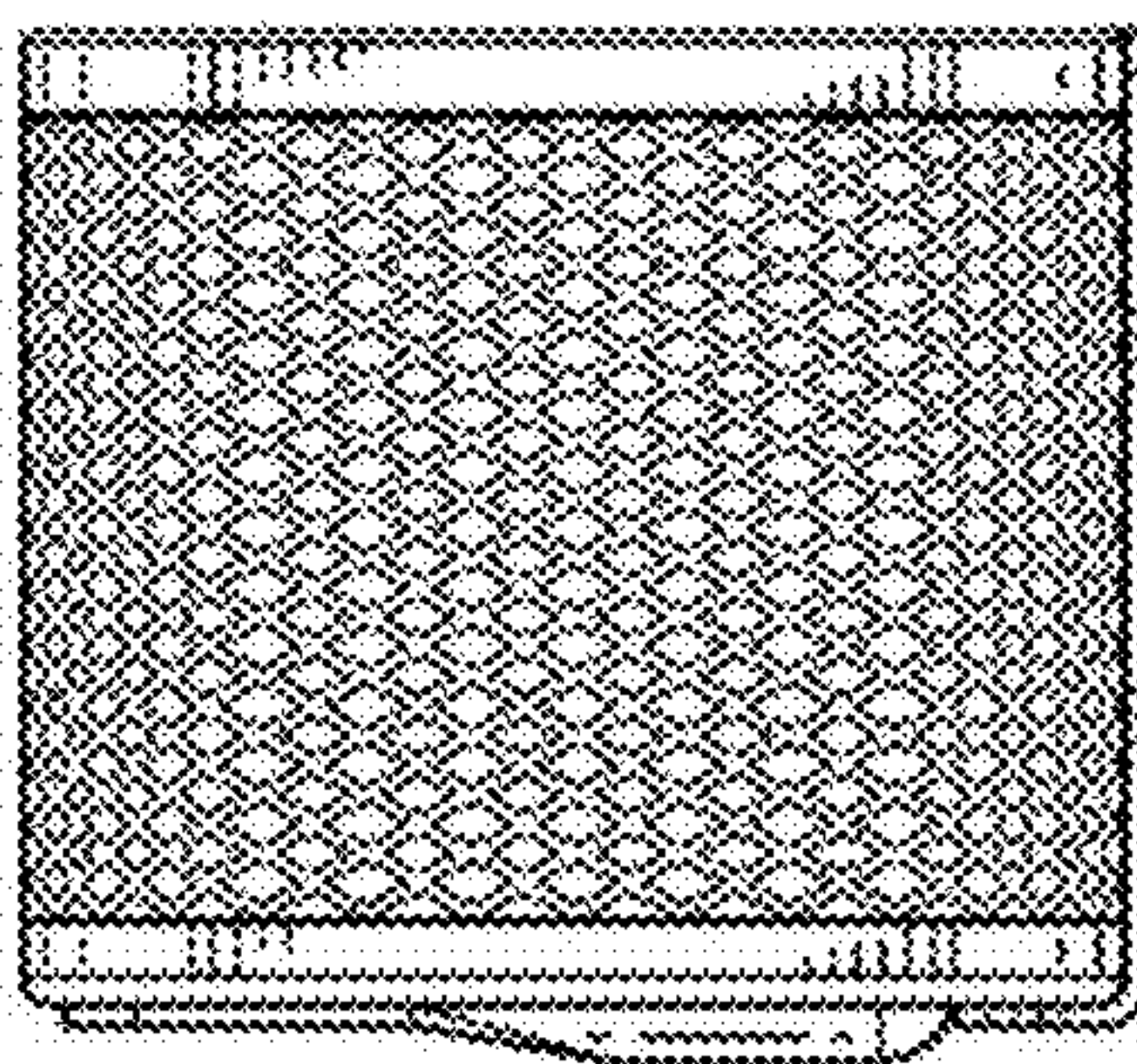

FIG. 21