



US00D775417S

(12) **United States Design Patent** (10) **Patent No.:** **US D775,417 S**
Cho (45) **Date of Patent:** **** Dec. 27, 2016**

(54) **HAIR DRYER**

(71) Applicant: **UNIL ELECTRONICS CORP.**, Seoul (KR)

(72) Inventor: **Ok-Nam Cho**, Seoul (KR)

(73) Assignee: **UNIL ELECTRONICS CORP.**, Seoul (KR)

(**) Term: **15 Years**

(21) Appl. No.: **29/528,534**

(22) Filed: **May 29, 2015**

(30) **Foreign Application Priority Data**

Feb. 24, 2015 (KR) 30-2015-0009406

(51) **LOC (10) Cl.** **28-03**

(52) **U.S. Cl.**
USPC **D28/13**

(58) **Field of Classification Search**
USPC D28/12-19; D8/29.1; D32/17-18, 31-34
CPC A45D 20/12; A45D 20/00
See application file for complete search history.

(56) **References Cited**

U.S. PATENT DOCUMENTS

D248,169 S * 6/1978 Yamamoto D28/13
D290,528 S * 6/1987 Muller D28/13
D353,224 S * 12/1994 Rizzuto, Jr. D28/13
D360,282 S * 7/1995 Anzuoni, Jr. D28/13
D439,372 S * 3/2001 Yip D28/13
D529,230 S * 9/2006 Koenemann D28/13

D535,746 S * 1/2007 Grove D24/144
D544,645 S * 6/2007 Ceva D28/13
D559,443 S * 1/2008 Smith D28/13
D577,861 S * 9/2008 Leung D28/13
D603,094 S * 10/2009 Piard D28/13
D617,048 S * 6/2010 Kim D28/13
2009/0255143 A1 * 10/2009 Lee A45D 20/12
34/97

OTHER PUBLICATIONS

Glampalm Airlight Professional Hairdryer, date first reviewed Jul. 17, 2013, myhaircare.com.au, © My Hair Care, site visited Aug. 12, 2016, Available from Internet, <https://www.myhaircare.com.au/Professional_Hairdryer_3064.html>.*

* cited by examiner

Primary Examiner — Cathron Brooks

Assistant Examiner — Sharon S Oum

(74) *Attorney, Agent, or Firm* — Weiss & Moy, P.C.;
Jeffrey D. Moy

(57) **CLAIM**

The ornamental design for a hair dryer, as shown and described.

DESCRIPTION

FIG. 1 is a perspective view of a hair dryer;
FIG. 2 is a front view of the hair dryer;
FIG. 3 is a rear view of the hair dryer;
FIG. 4 is a left-side view of the hair dryer;
FIG. 5 is a right-side view of the hair dryer;
FIG. 6 is a plan view of the hair dryer; and,
FIG. 7 is a bottom view of the hair dryer.

1 Claim, 6 Drawing Sheets

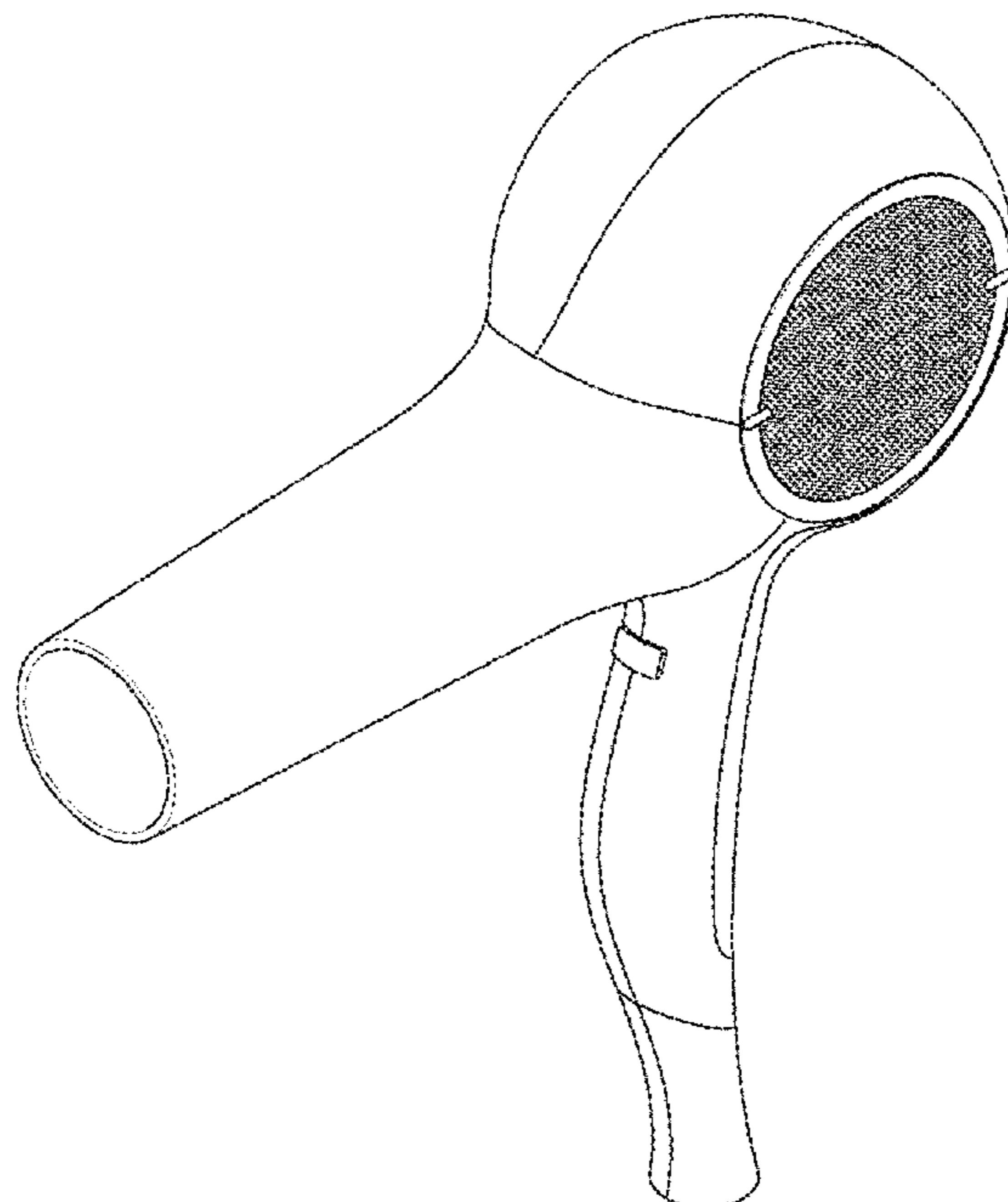

Fig. 1

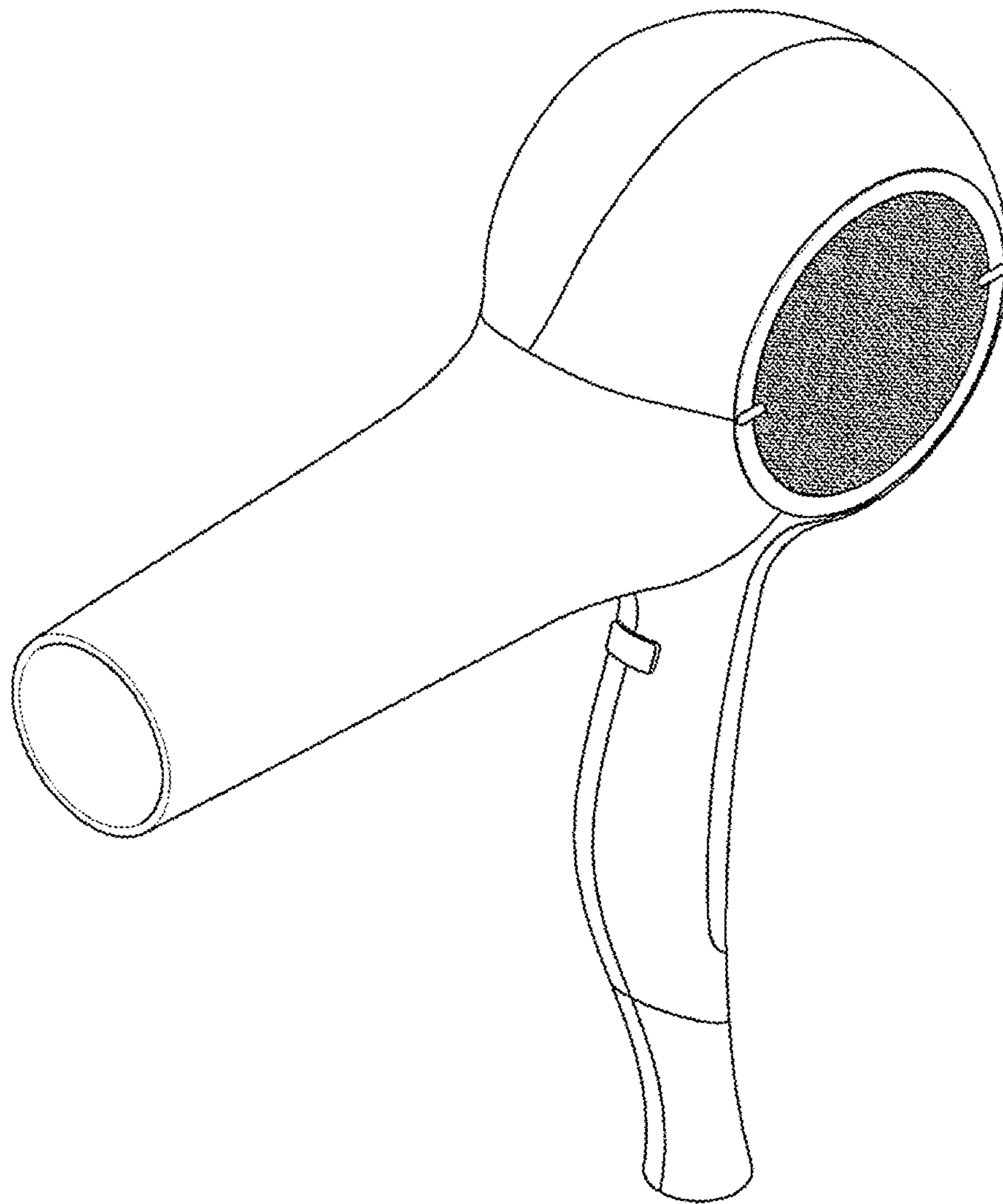

Fig. 2

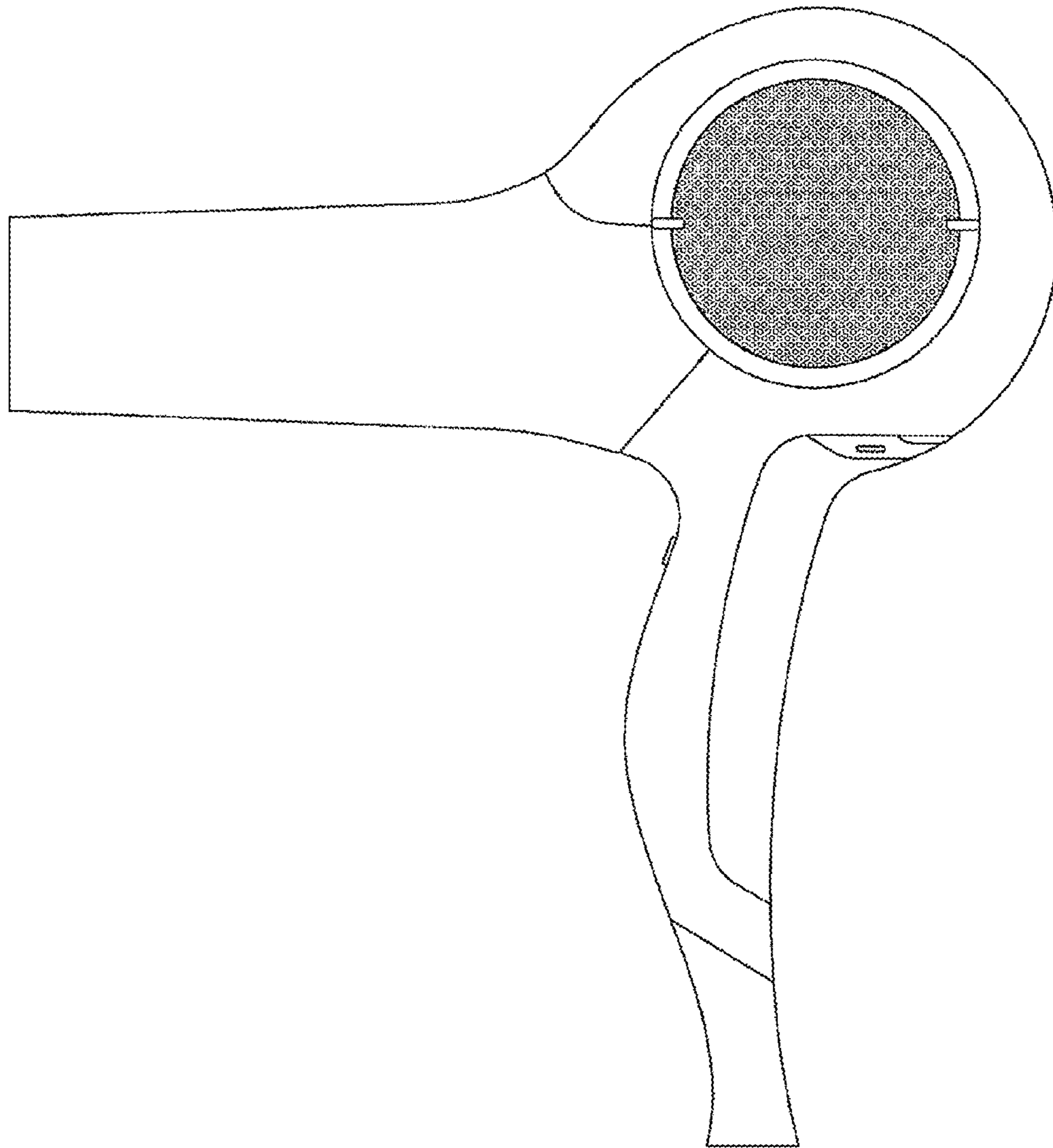

Fig. 3

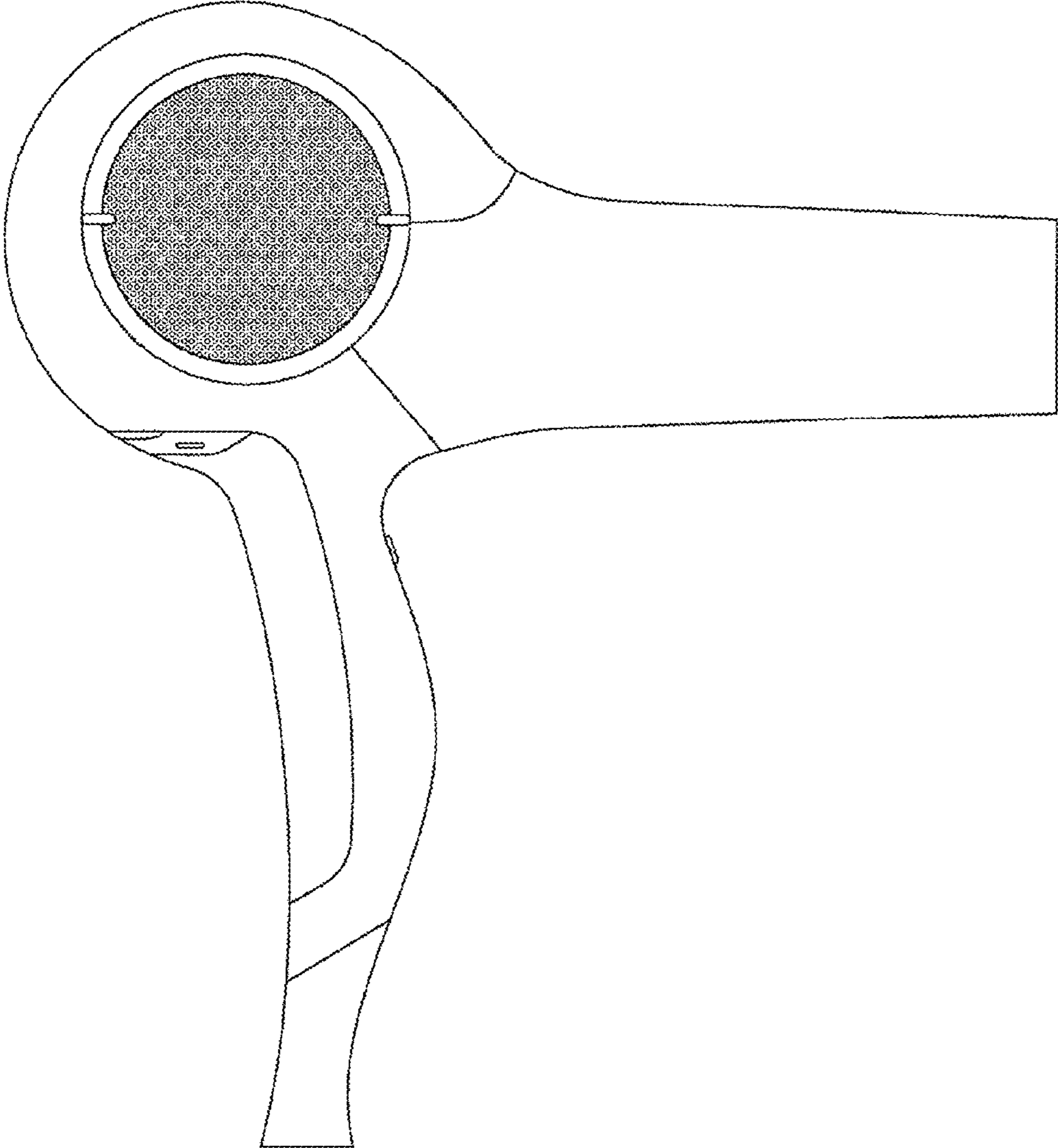

Fig. 4

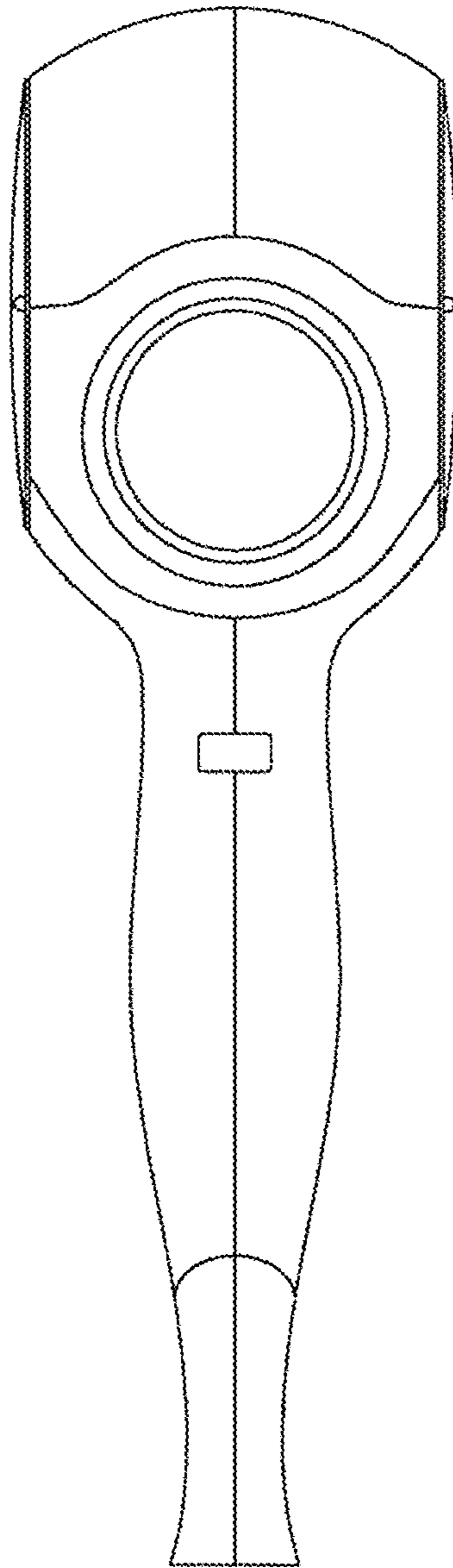

Fig. 5

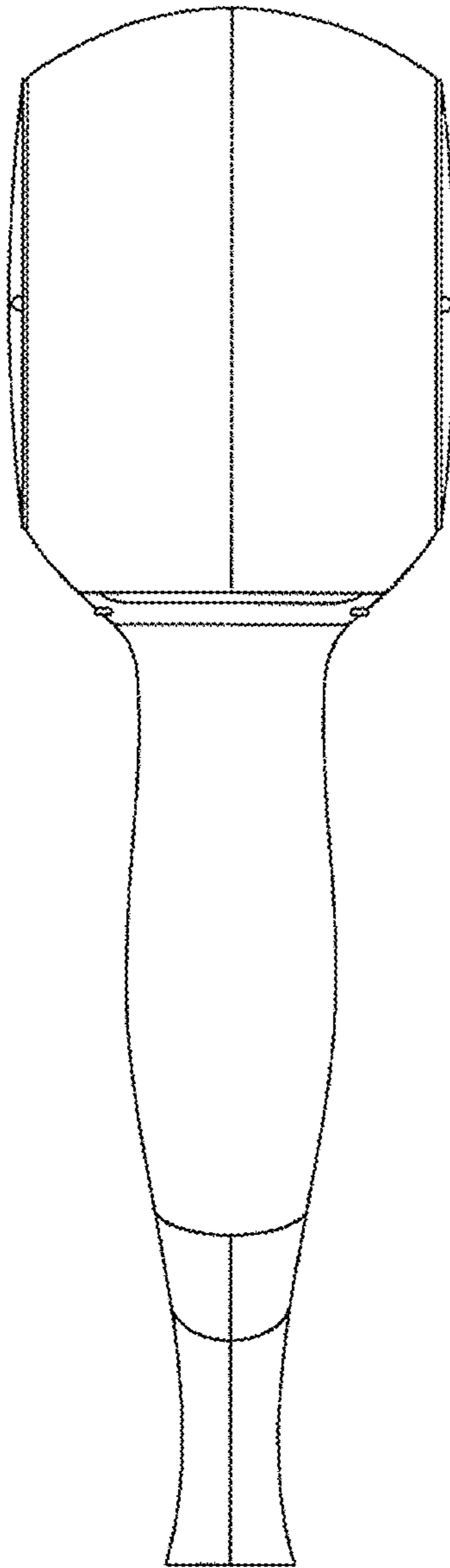

Fig. 6

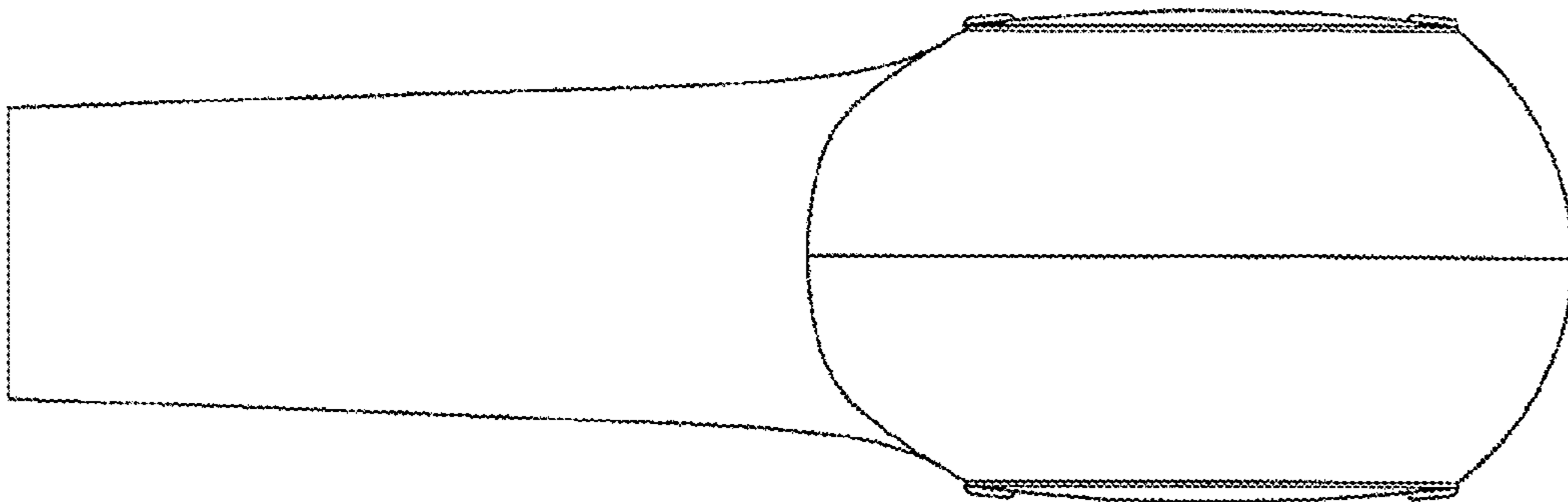

Fig. 7

