

US00D775301S

(12) **United States Design Patent** (10) **Patent No.:** **US D775,301 S**
Barnett (45) **Date of Patent:** **** Dec. 27, 2016**

- (54) **CROSSBOW STOCK**
- (71) Applicant: **Barnett Outdoors, LLC**, Tarpon Springs, FL (US)
- (72) Inventor: **David A. Barnett**, Tarpon Springs, FL (US)
- (73) Assignee: **Barnett Outdoors, LLC**, Tarpon Springs, FL (US)
- (**) Term: **15 Years**
- (21) Appl. No.: **29/532,960**
- (22) Filed: **Jul. 13, 2015**
- (51) **LOC (10) Cl.** **22-01**
- (52) **U.S. Cl.**
USPC **D22/107**
- (58) **Field of Classification Search**
USPC D22/107; D21/571, 575
CPC F41B 5/12; F41B 5/148
See application file for complete search history.

D716,402 S *	10/2014	Barnett	D22/107
D718,404 S *	11/2014	Barnett	D22/107
D718,830 S *	12/2014	Barnett	D22/107
D718,831 S *	12/2014	Barnett	D22/107
9,255,755 B1 *	2/2016	Barnett	F41B 5/143
9,303,945 B1 *	4/2016	Hughes	F41B 5/123
2014/0216429 A1 *	8/2014	Biafore, Jr.	F41B 5/12 124/25

* cited by examiner

Primary Examiner — Michael A Pratt

(74) *Attorney, Agent, or Firm* — Jones Walker, LLP

(57) **CLAIM**

I claim the ornamental design for a crossbow stock, as shown and described.

DESCRIPTION

FIG. 1 is a perspective view of my new design;
 FIG. 2 is a front view thereof;
 FIG. 3 is a rear view thereof;
 FIG. 4 is a left side view thereof;
 FIG. 5 is a right side view thereof;
 FIG. 6 is a top view thereof; and,
 FIG. 7 is a bottom view thereof.
 The broken lines in FIGS. 1-7 are for illustrative purposes and form no part of the claimed design.

1 Claim, 4 Drawing Sheets

- (56) **References Cited**
U.S. PATENT DOCUMENTS
D716,398 S * 10/2014 Barnett D22/107
D716,399 S * 10/2014 Barnett D22/107

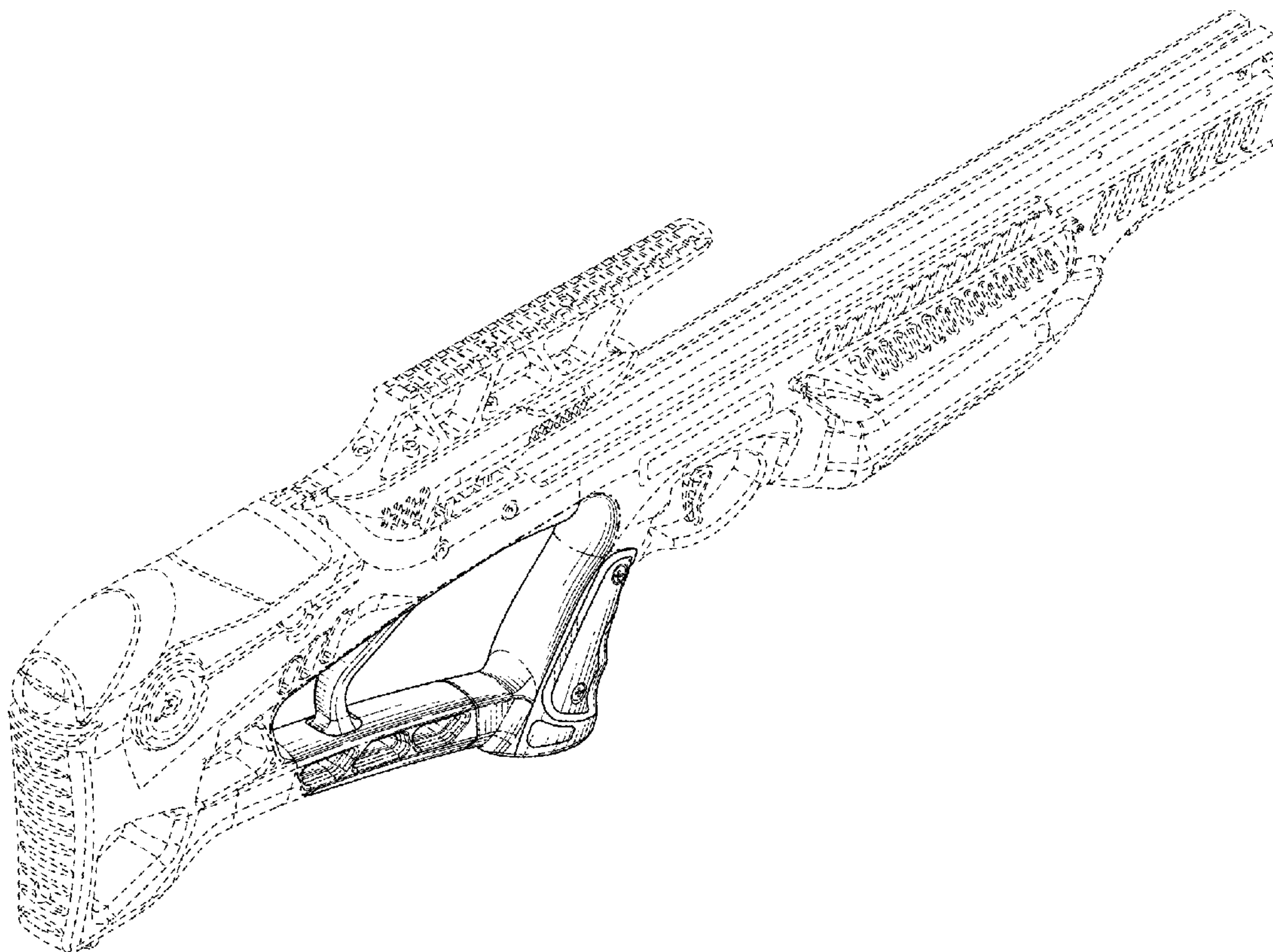

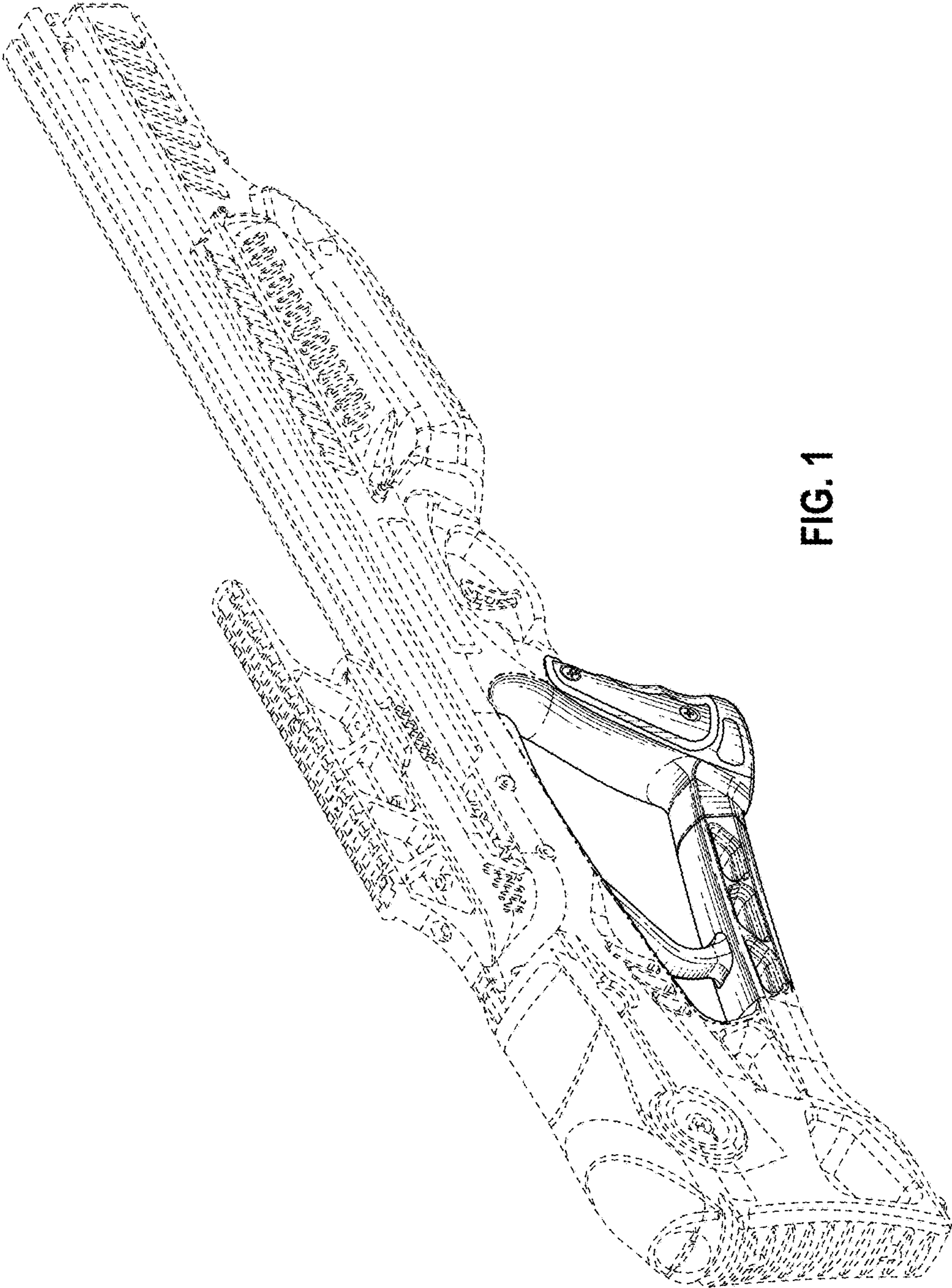

FIG. 1

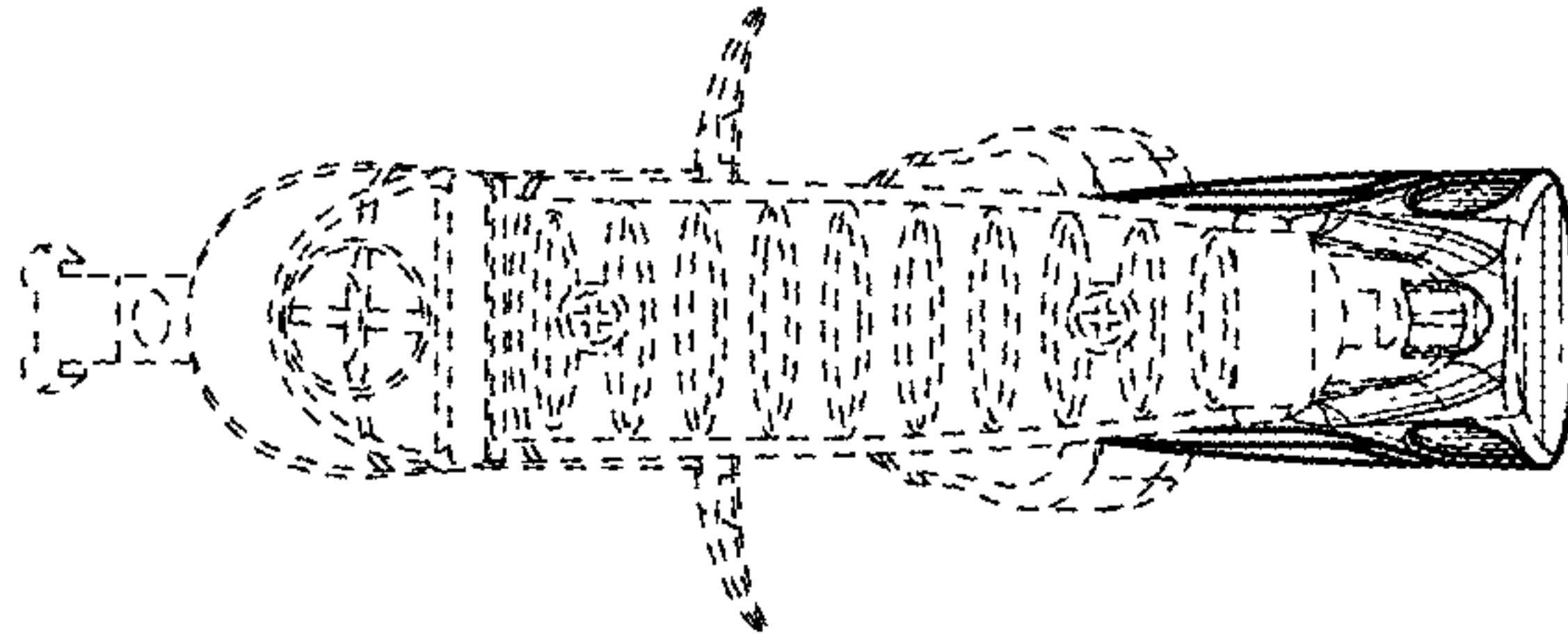

FIG. 3

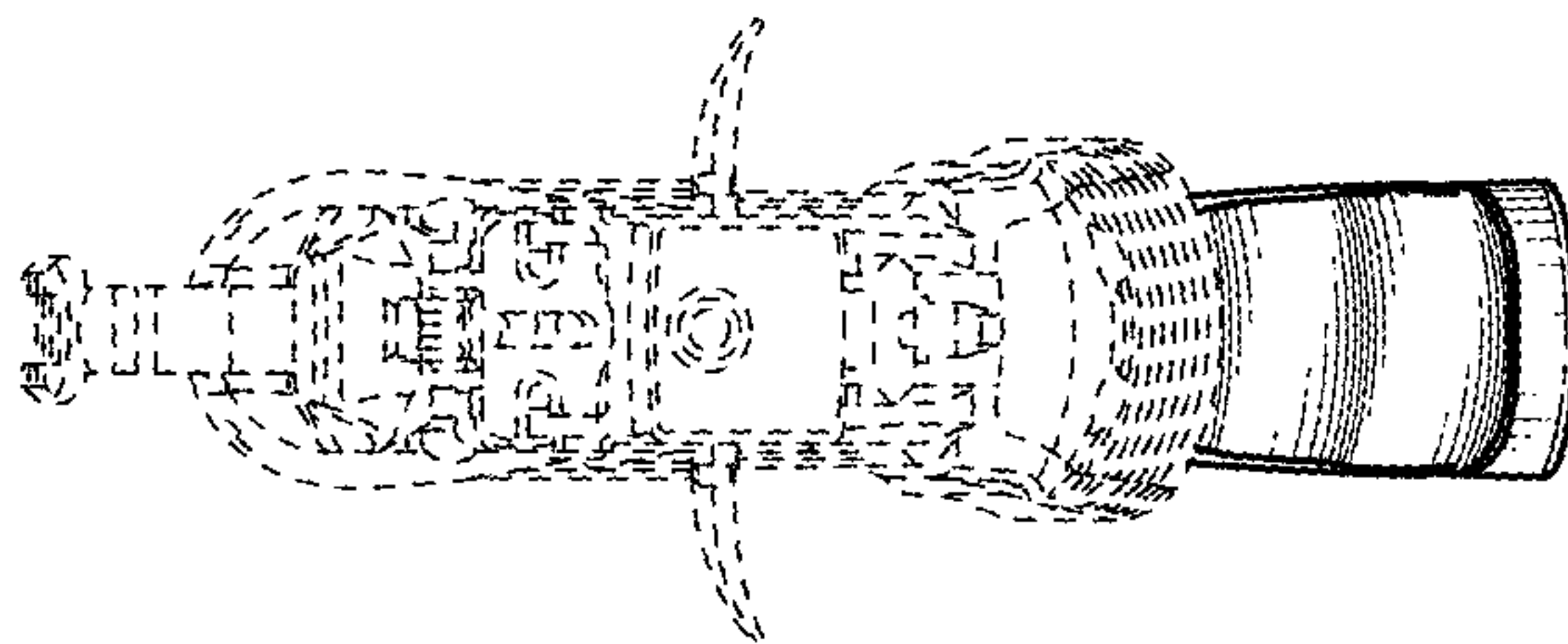

FIG. 2

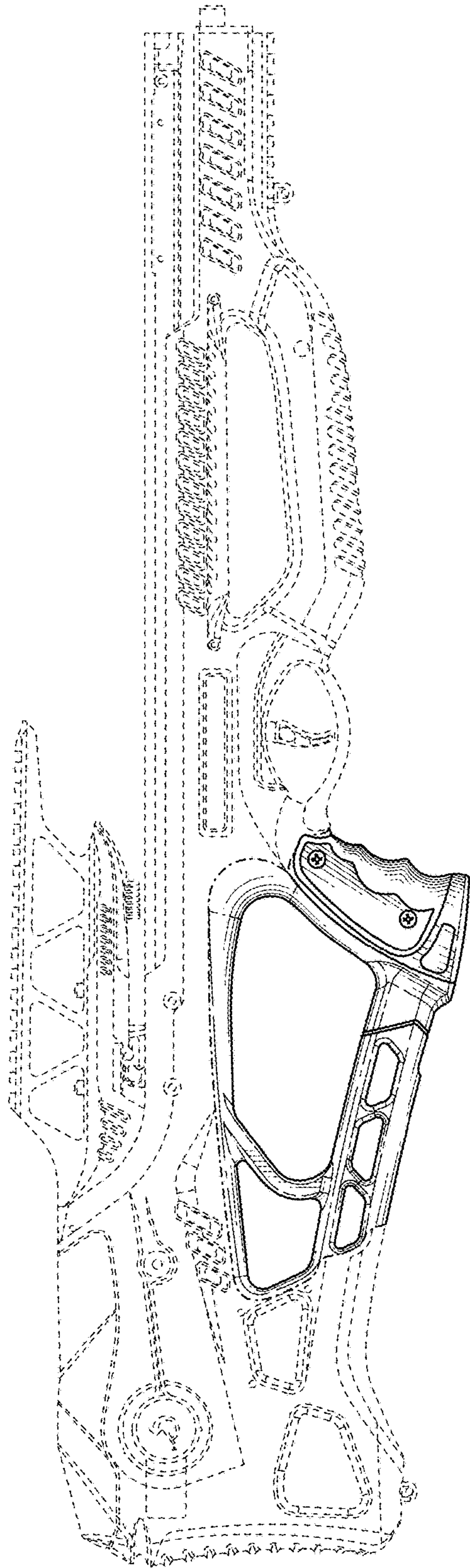

FIG. 4

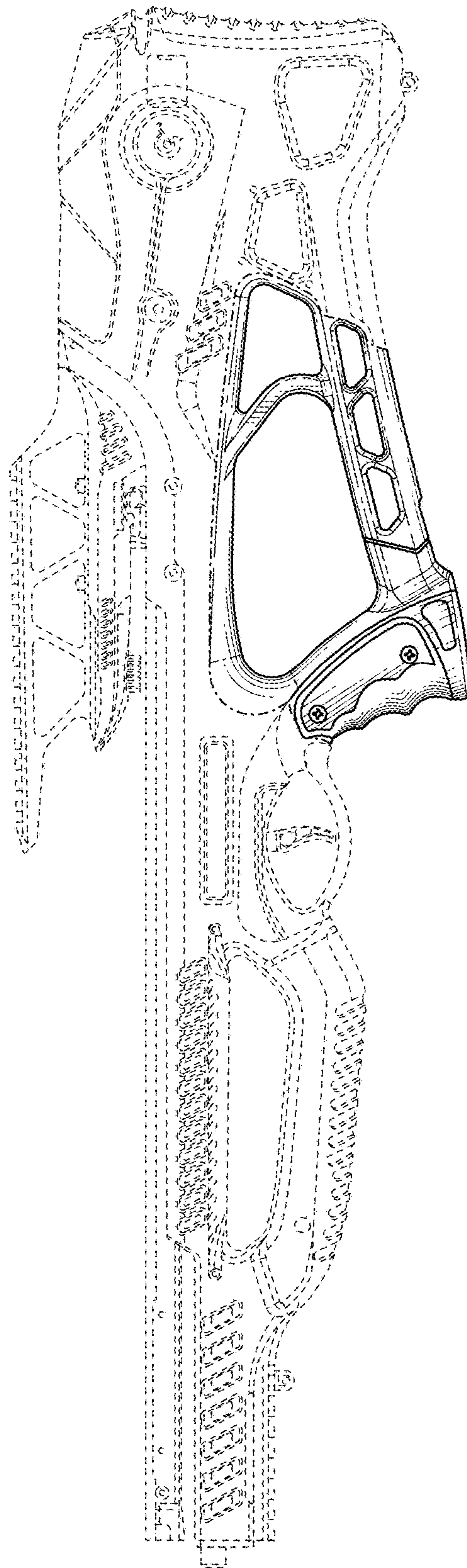

FIG. 5

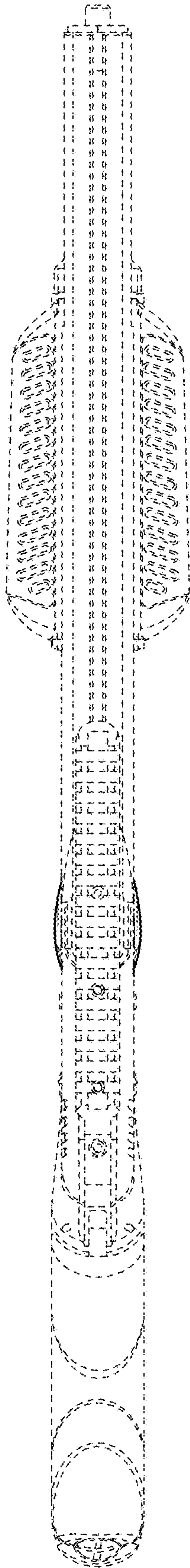

FIG. 6

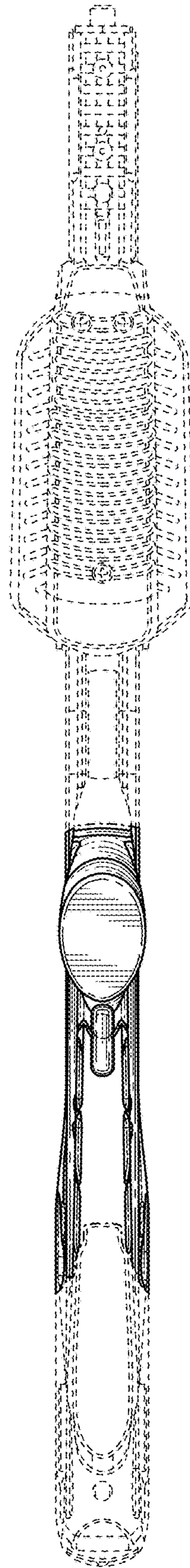

FIG. 7