



US00D775235S

(12) **United States Design Patent** (10) **Patent No.:** **US D775,235 S**
Huckey (45) **Date of Patent:** **** Dec. 27, 2016**

(54) **WATER PUMP MOUNTING PLATE**
(71) Applicant: **Brent W. Huckey**, Mesa, AZ (US)
(72) Inventor: **Brent W. Huckey**, Mesa, AZ (US)
(**) Term: **15 Years**
(21) Appl. No.: **29/538,039**
(22) Filed: **Aug. 31, 2015**
(51) **LOC (10) Cl.** **15-01**
(52) **U.S. Cl.**
USPC **D15/5**
(58) **Field of Classification Search**
USPC D15/1-5, 7, 9, 8; D23/231, 232, 225;
123/41.47
CPC F01L 1/185; F01L 2001/186; F01L
2001/187; F01L 2001/188; F01L 1/181;
F01L 1/182; F01P 5/10
See application file for complete search history.

(56) **References Cited**

U.S. PATENT DOCUMENTS

4,215,658 A * 8/1980 Smith, Jr. F01P 5/10
123/195 A
D268,585 S * 4/1983 Drakulic D15/5
D287,130 S * 12/1986 Tilton, Jr. D15/5
6,363,918 B2 * 4/2002 Håkansson F01P 5/12
123/198 C
D645,478 S * 9/2011 Iwanicki D15/7
8,424,497 B2 4/2013 Iwanicki
8,869,776 B2 * 10/2014 Yamane F01L 1/34
123/195 R
2007/0266806 A1 11/2007 Jones
2010/0162974 A1 7/2010 Yamanishi et al.
2011/0088638 A1 * 4/2011 Yamagata F01P 5/10
123/41.44

2012/0079997 A1 * 4/2012 Iwanicki F01P 5/10
123/41.44
2012/0192816 A1 * 8/2012 Simon F01P 5/10
123/41.44
2014/0224194 A1 * 8/2014 Barnes F01P 5/04
123/41.44
2015/0285205 A1 * 10/2015 Burkle F01P 5/10
29/888.011

* cited by examiner

Primary Examiner — T. Chase Nelson

Assistant Examiner — Ania Aman

(74) *Attorney, Agent, or Firm* — Mark V. Loen

(57) **CLAIM**

The ornamental design for a water pump mounting plate, as shown and described.

DESCRIPTION

FIG. 1 is a front view of a water pump mounting plate; FIG. 2 is a left side view of FIG. 1; FIG. 3 is a right side view of FIG. 1; FIG. 4 is a top side view of FIG. 1; FIG. 5 is a lower side view of FIG. 1; FIG. 6 is a perspective view of the water pump mounting plate; wherein the mounting plate is incorporated into a water pump; the bottom view of FIG. 1 is unadorned; and, FIG. 7 is an exploded perspective view of the water pump mounting plate.

The broken lines shown in FIGS. 1 through 5 which are immediately adjacent to the claimed surfaces and encompass regions without claimed features, represent the bounds of the claimed design, while the broken lines in FIGS. 6 and 7 are for purposes of illustrating environmental structure associated with the claimed design in condition of use, and which forms no part of the claimed design.

1 Claim, 3 Drawing Sheets

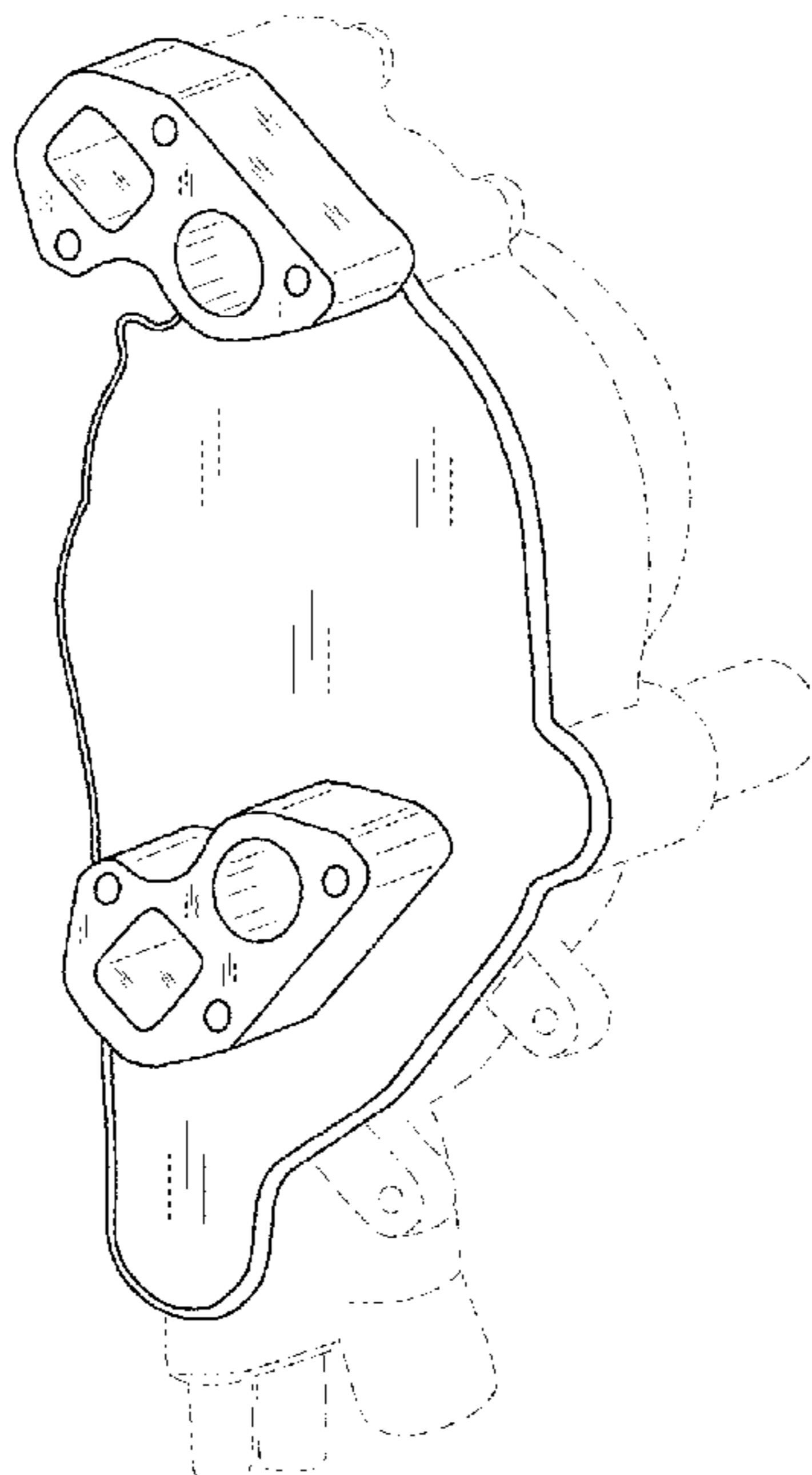

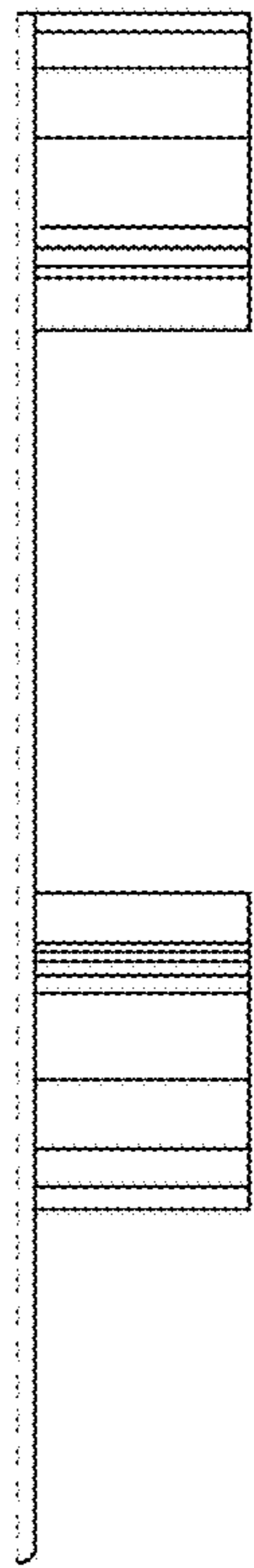

FIG. 2

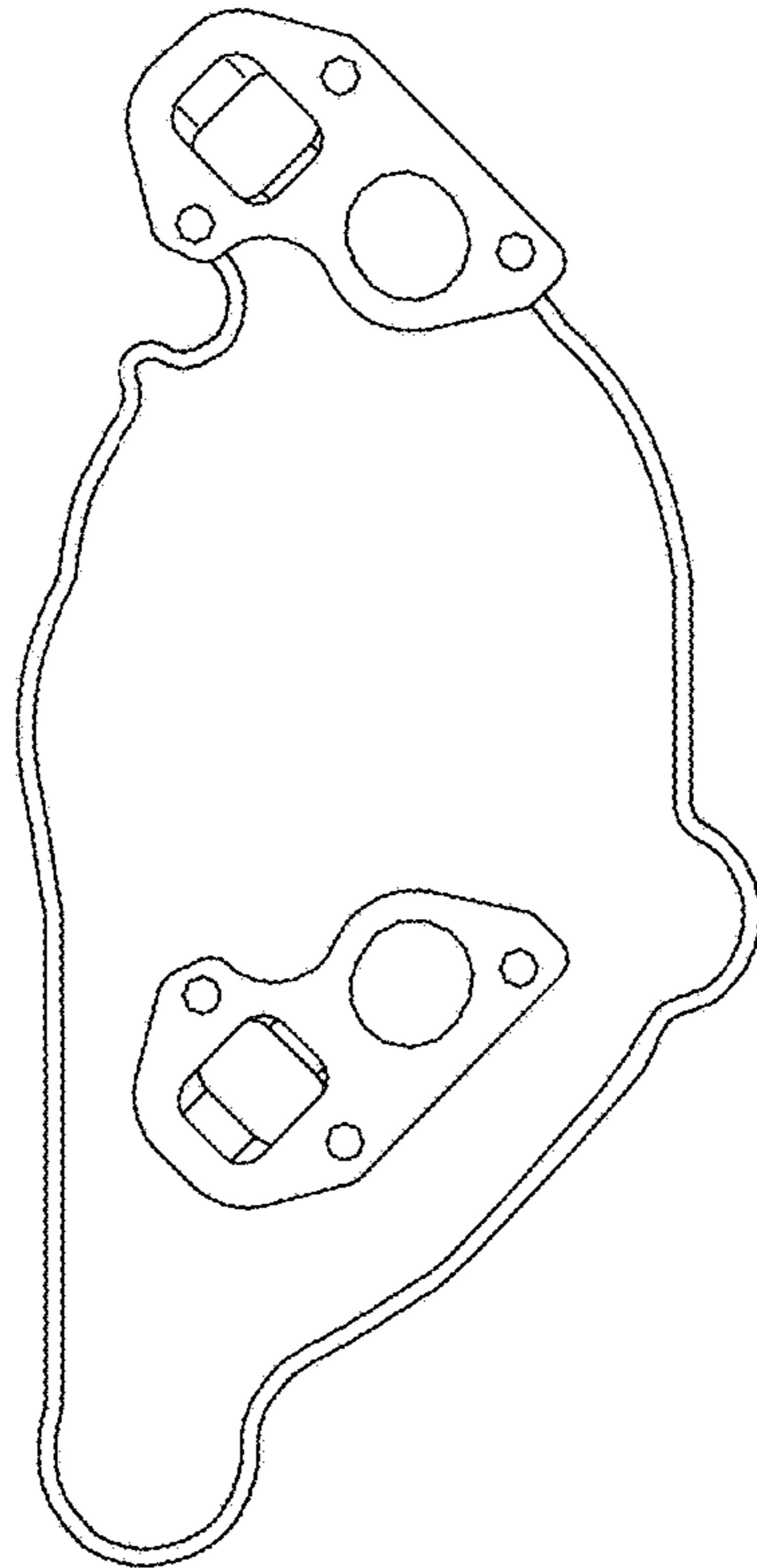

FIG. 1

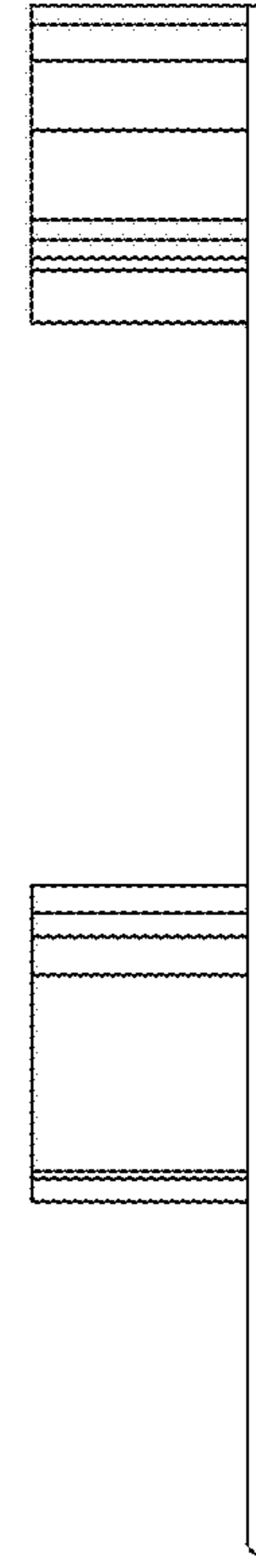

FIG. 3

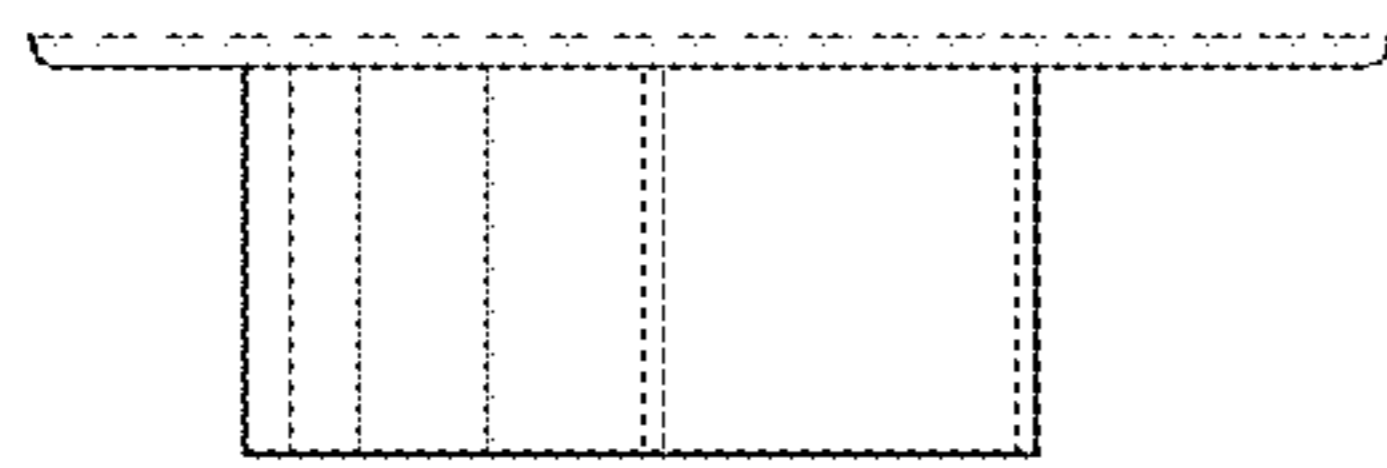

FIG. 4

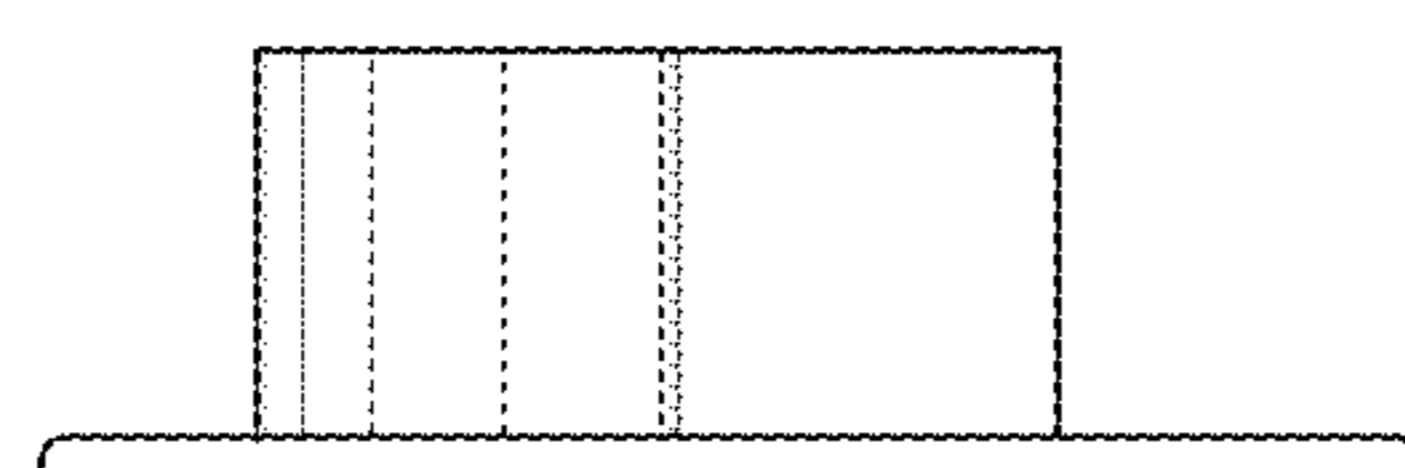

FIG. 5

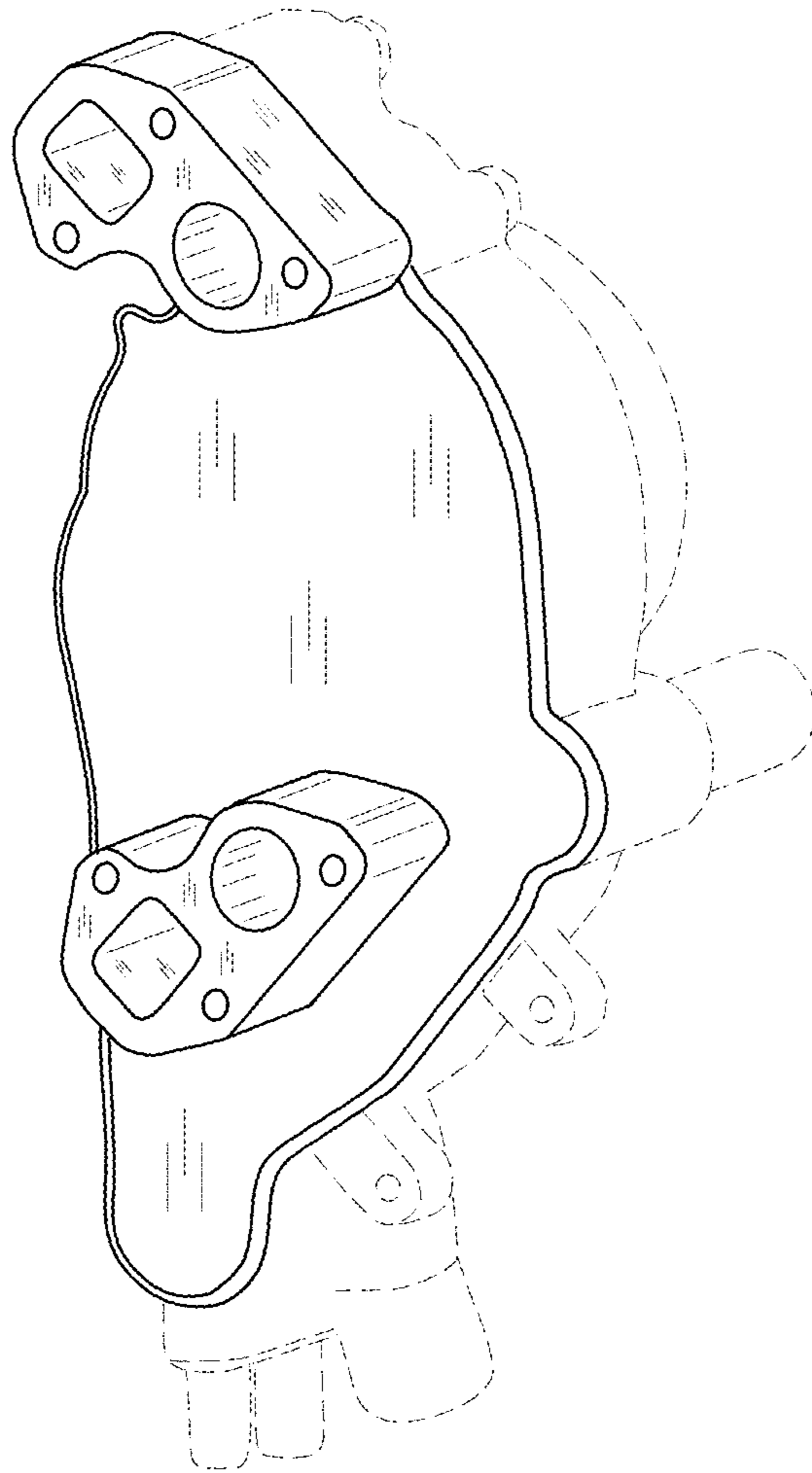

FIG. 6

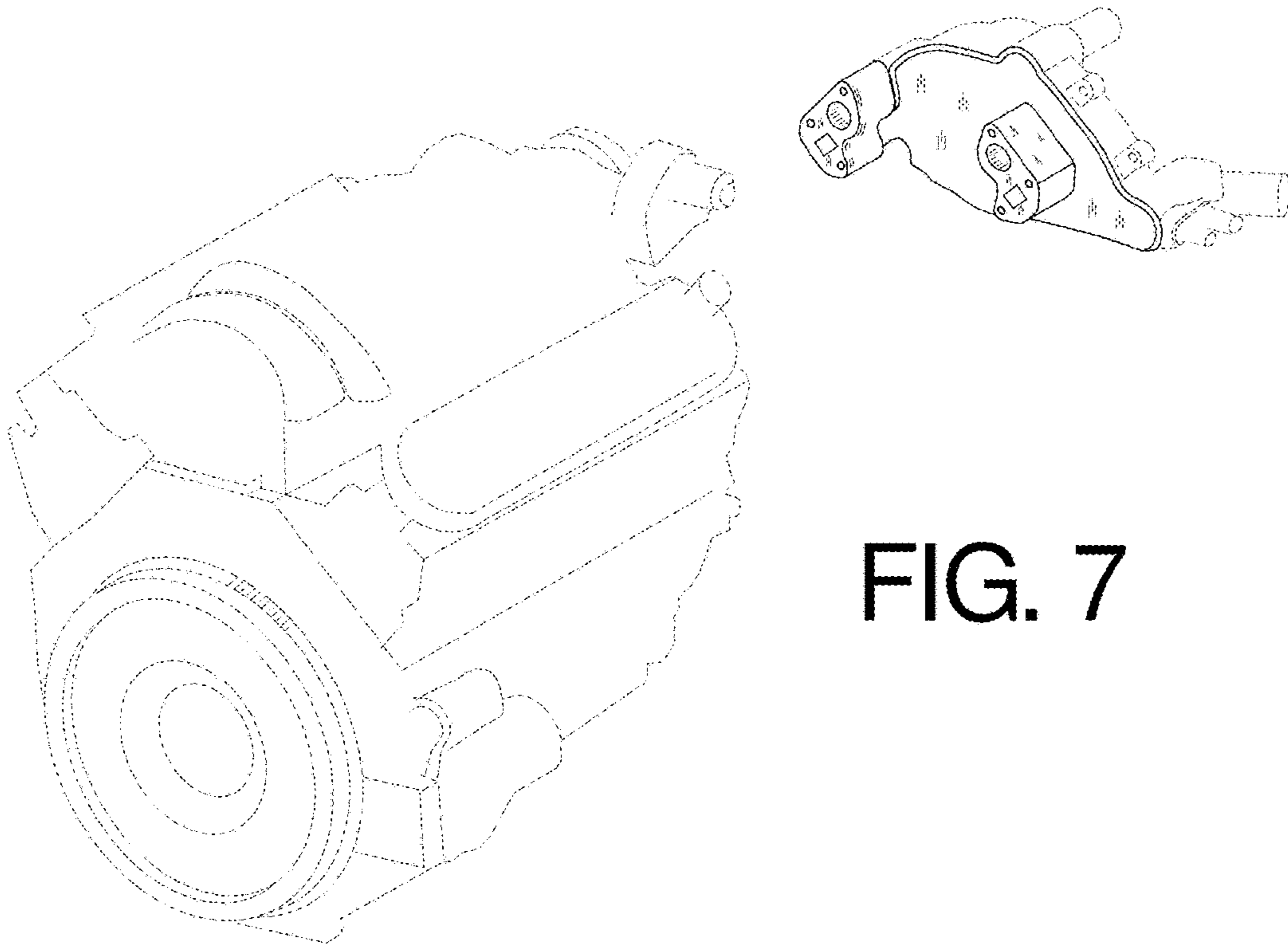

FIG. 7