



US00D774990S

(12) **United States Design Patent** (10) **Patent No.:** **US D774,990 S**
Calley et al. (45) **Date of Patent:** **** Dec. 27, 2016**

(54) **MOTORCYCLE GUARD**

(71) Applicants: **Jason Calley**, Kingwood, TX (US);
Mikael Smith, Kingwood, TX (US)
(72) Inventors: **Jason Calley**, Kingwood, TX (US);
Mikael Smith, Kingwood, TX (US)

(**) Term: **15 Years**

(21) Appl. No.: **29/534,428**

(22) Filed: **Jul. 28, 2015**

(51) **LOC (10) Cl.** **12-11**

(52) **U.S. Cl.**
USPC **D12/126**

(58) **Field of Classification Search**
USPC D12/110, 114, 117, 118, 126; D8/354,
D8/394, 396; D23/262-265; 29/525.02;
280/276, 279, 304.3
CPC B62K 25/02; B62J 23/00
See application file for complete search history.

(56) **References Cited**

U.S. PATENT DOCUMENTS

629,667	A	7/1899	Denbigh	
3,762,982	A *	10/1973	Whittington	F16L 11/12
				138/110
4,105,220	A *	8/1978	Pacific	B62J 23/00
				280/304.4
4,138,132	A *	2/1979	Doyle	B62J 23/00
				264/163
D298,802	S *	12/1988	Tekirian	D8/396
D313,774	S *	1/1991	Hauer	D12/126
5,183,281	A *	2/1993	Stephens	B62K 21/02
				280/279
D341,343	S *	11/1993	Netz	D12/126
5,397,146	A *	3/1995	Fischer	B62J 23/00
				280/288.4
5,687,773	A	11/1997	Ryan et al.	
6,419,039	B1 *	7/2002	Wagner	B62J 27/00
				180/219

(Continued)

OTHER PUBLICATIONS

“19 Most Wanted Frame Guards.” Motorcycle Product Reviews., Jul. 29, 2015 [online], [retrieved on Aug. 15, 2016]. Retrieved from the Internet <URL: <http://www.motorcycleproductsreviews.com/19-most-wanted-frame-guards/>>.*

(Continued)

Primary Examiner — Darlington Ly

(74) *Attorney, Agent, or Firm* — Buche & Associates, P.C.; John K. Buche; Scott D. Compton

(57) **CLAIM**

The ornamental design for a motorcycle guard, as shown and described.

DESCRIPTION

FIG. 1 is a perspective top view of a motorcycle guard showing our new design;
FIG. 2 is a bottom view thereof;
FIG. 3 is a top view thereof;
FIG. 4 is a right side view thereof, the left side being a mirror image thereof;
FIG. 5 is a front view thereof, the back being a mirror image thereof;
FIG. 6 is a top perspective view thereof, wherein the motorcycle guard is shown in conjunction with supporting environmental structure; and,
FIG. 7 is a top and side perspective view thereof, wherein the motorcycle guard is shown installed on a motorcycle.
In FIGS. 1-5, the broken lines showing the apertures illustrate portions of the motorcycle guard that forms no part of the claimed design. Additionally, in FIGS. 6 and 7, the broken lines showing the supporting structures and motorcycle are provided for the purposes of illustrating environmental structure and also forms no part of the claimed design.

1 Claim, 3 Drawing Sheets

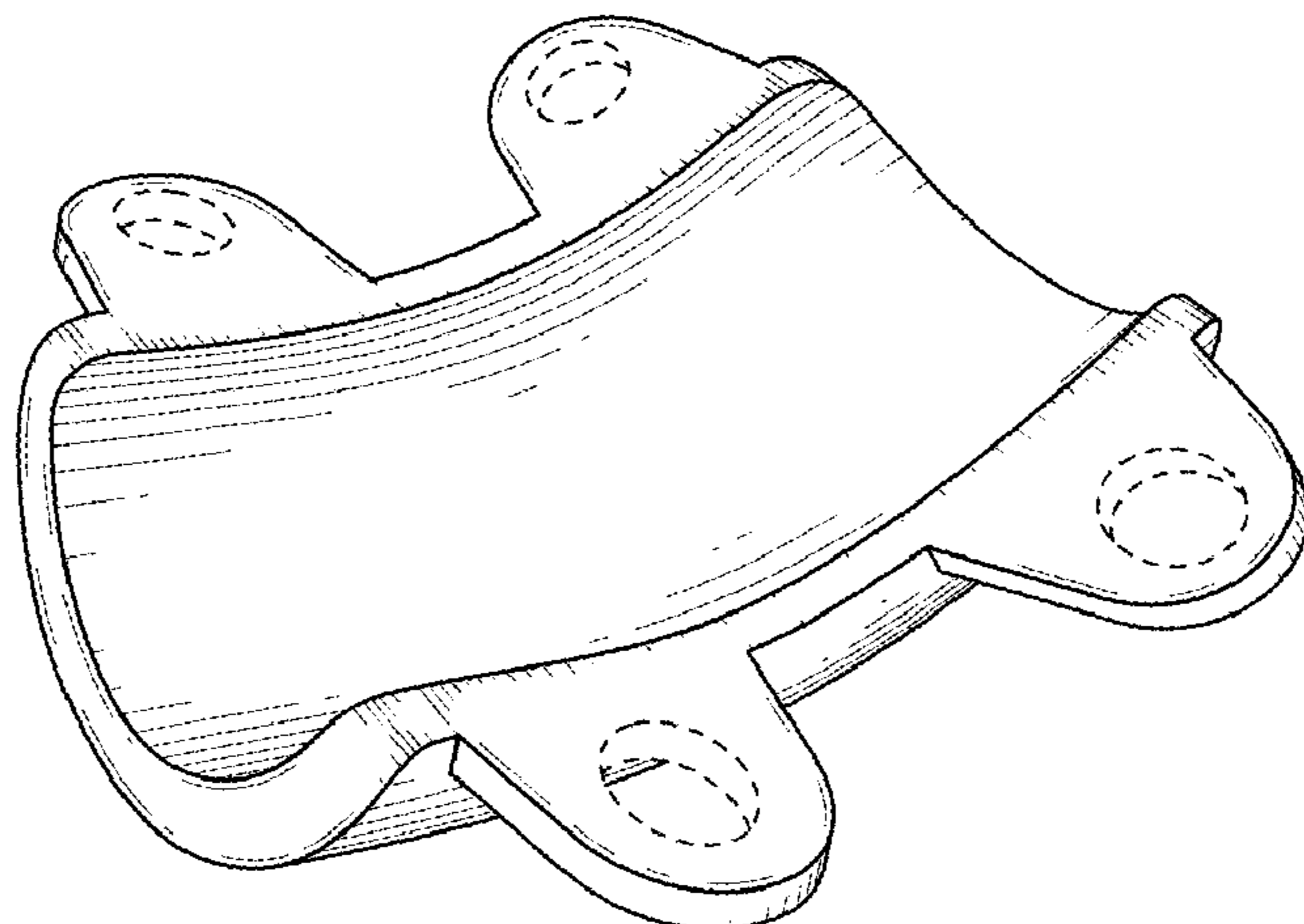

(56)

References Cited

U.S. PATENT DOCUMENTS

D491,112	S *	6/2004	Francis	D12/126
6,837,509	B2	1/2005	Welch et al.		
7,144,030	B2 *	12/2006	Buell	B62J 27/00 180/219
D560,764	S *	1/2008	Gibb	D23/265
D587,347	S *	2/2009	Madara	D23/265
D598,077	S *	8/2009	Gibb	D23/265
D600,326	S *	9/2009	Gibb	D23/265
7,637,520	B2 *	12/2009	Madden	B62K 25/08 180/219
D742,213	S *	11/2015	Sasanecki	D8/396
2004/0046359	A1	3/2004	Welch et al.		
2012/0091686	A1 *	4/2012	Hutchinson	B62J 25/00 280/291
2012/0133115	A1	5/2012	Roziere et al.		

OTHER PUBLICATIONS

“KTM Frame Protection Decals (Orange) 16-17.” KTM Parts., Jul. 10, 2015 [online], [retrieved on Aug. 15, 2016]. Retrieved from the Internet <URL: <http://www.ktm-parts.com/7940399400004.html>>.*

“Shifter Sock Boot Shoe Protector Shift Cover Motorcycle.” Bang Good., Jan. 4, 2015 [online], [retrieved on Aug. 15, 2016]. Retrieved from the Internet <URL: <http://www.banggood.com/Shifter-Sock-Boot-Shoe-Protector-Shift-Cover-Motorcycle-p-944514.html>>.*

* cited by examiner

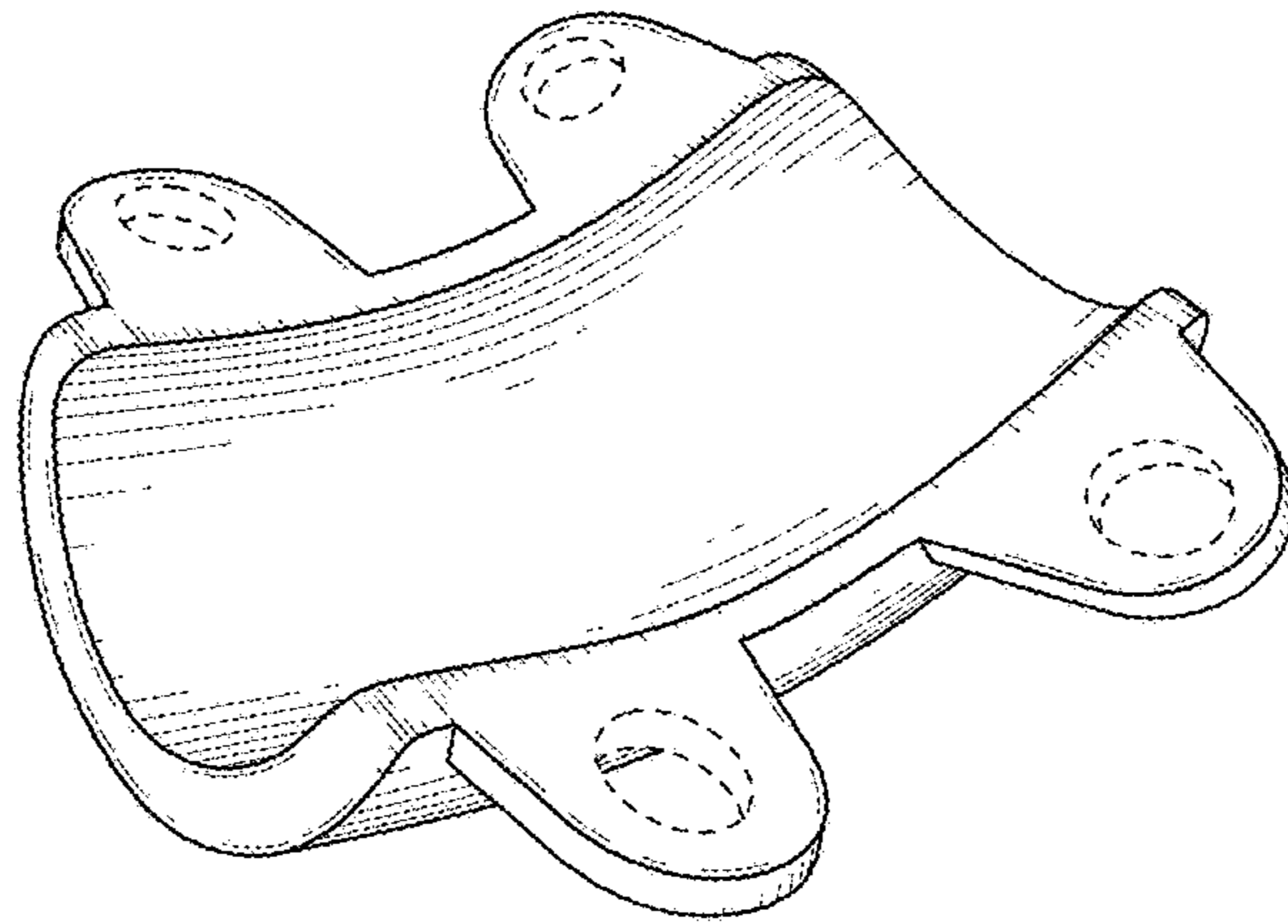

FIG. 1

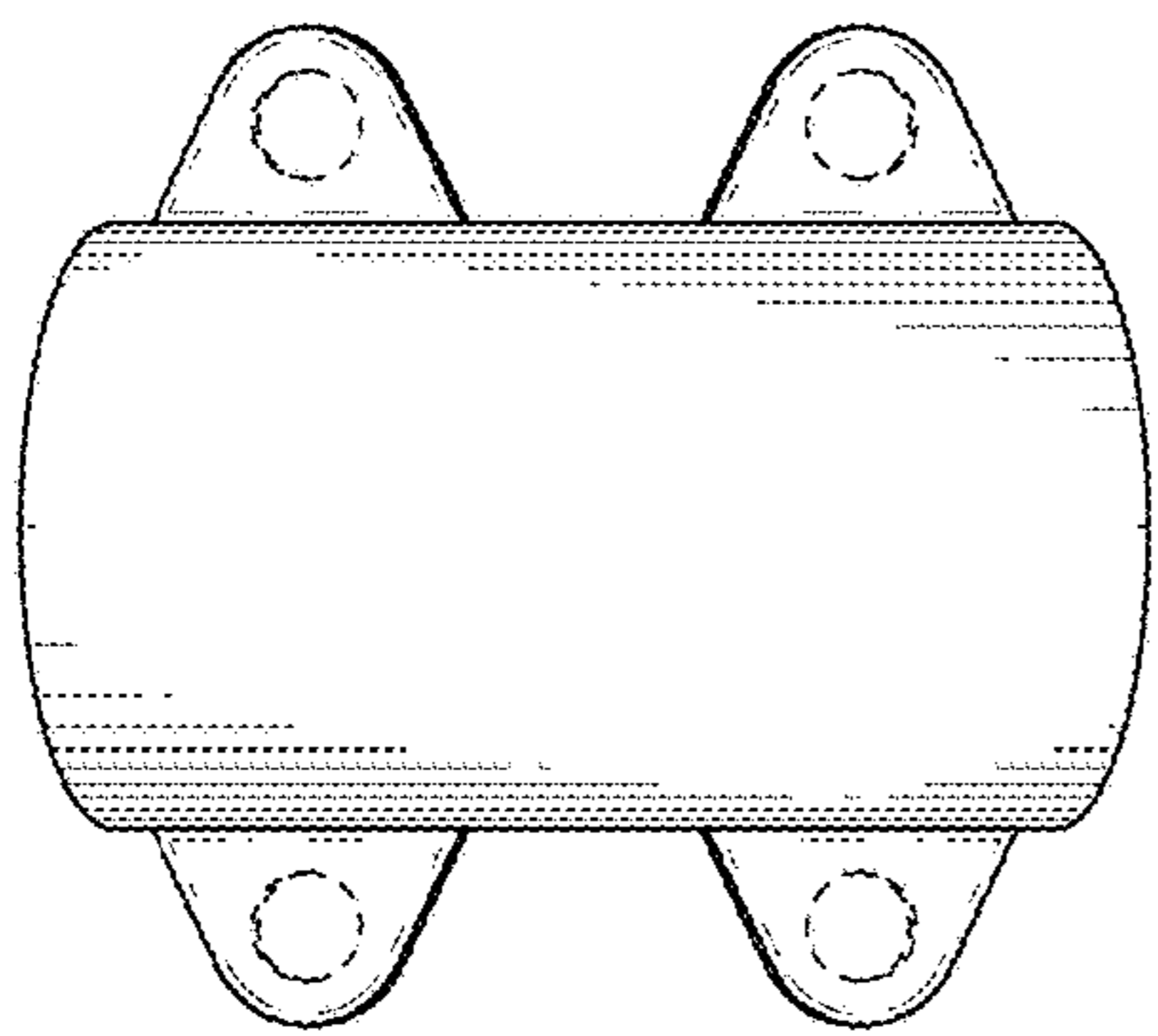

FIG. 2

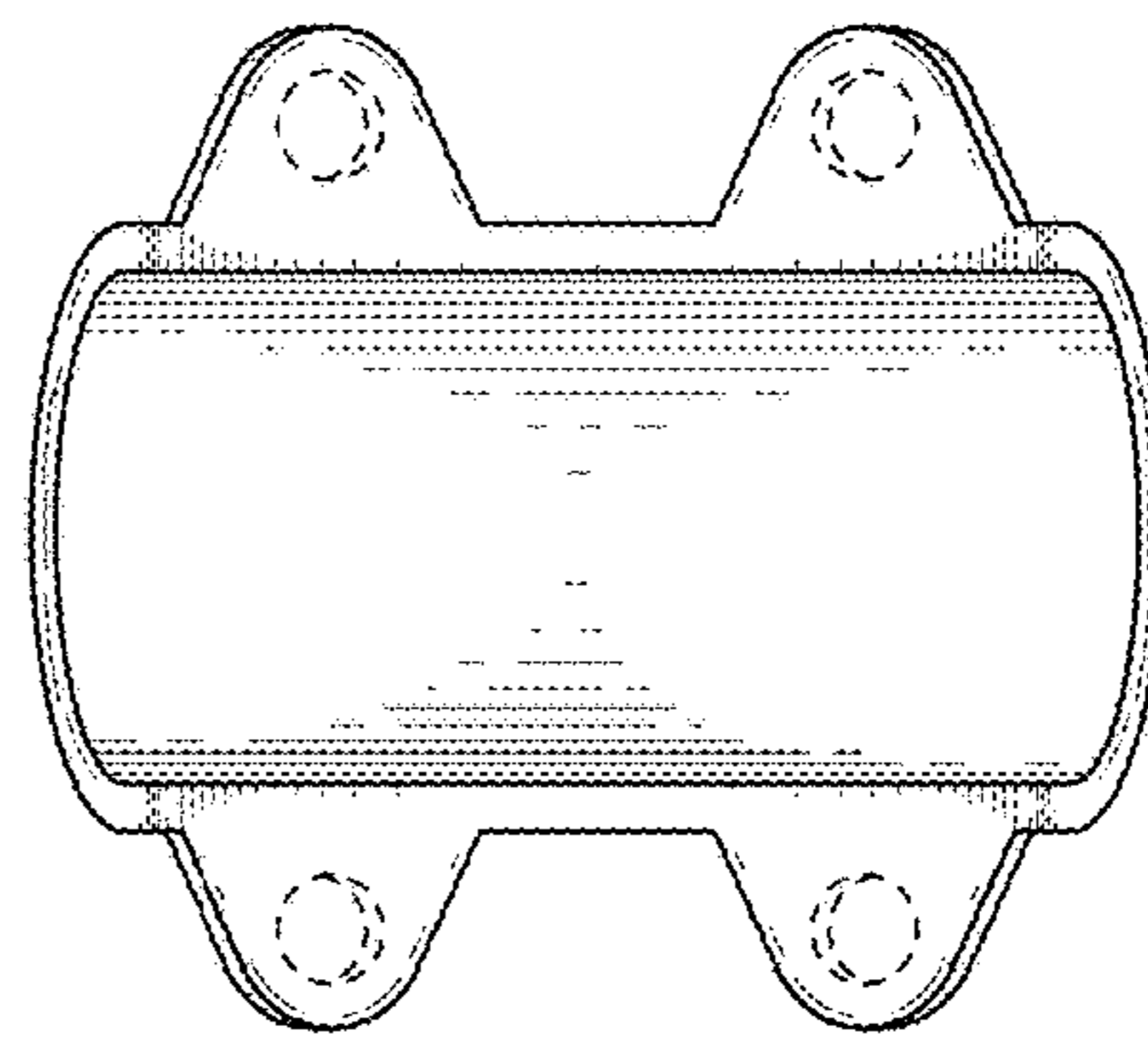

FIG. 3

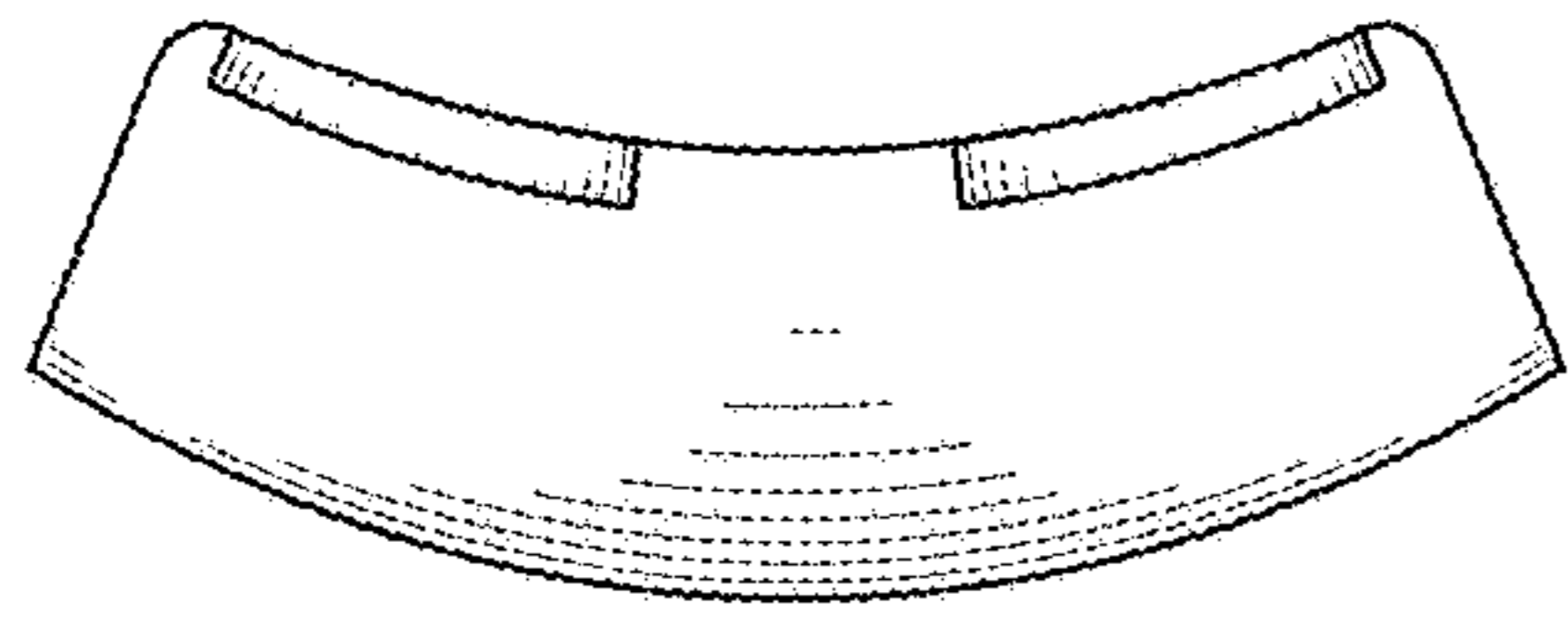

FIG. 4

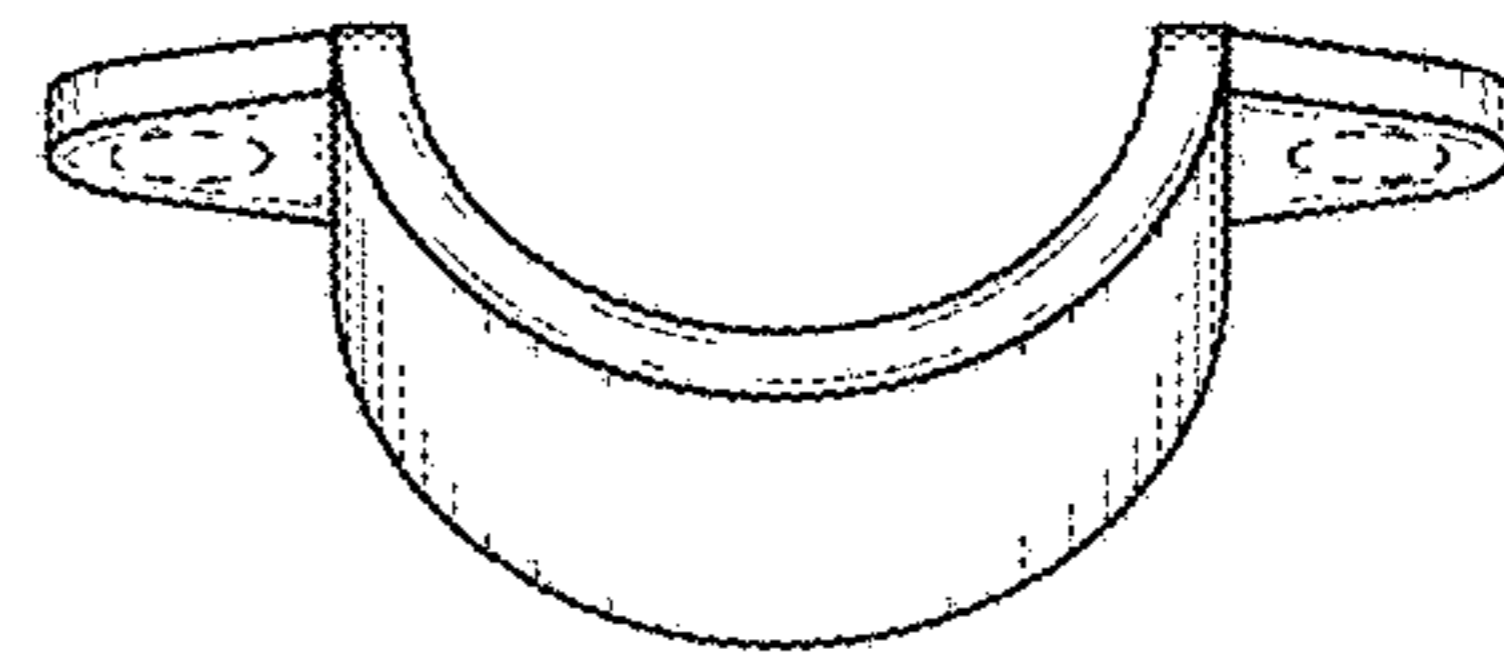

FIG. 5

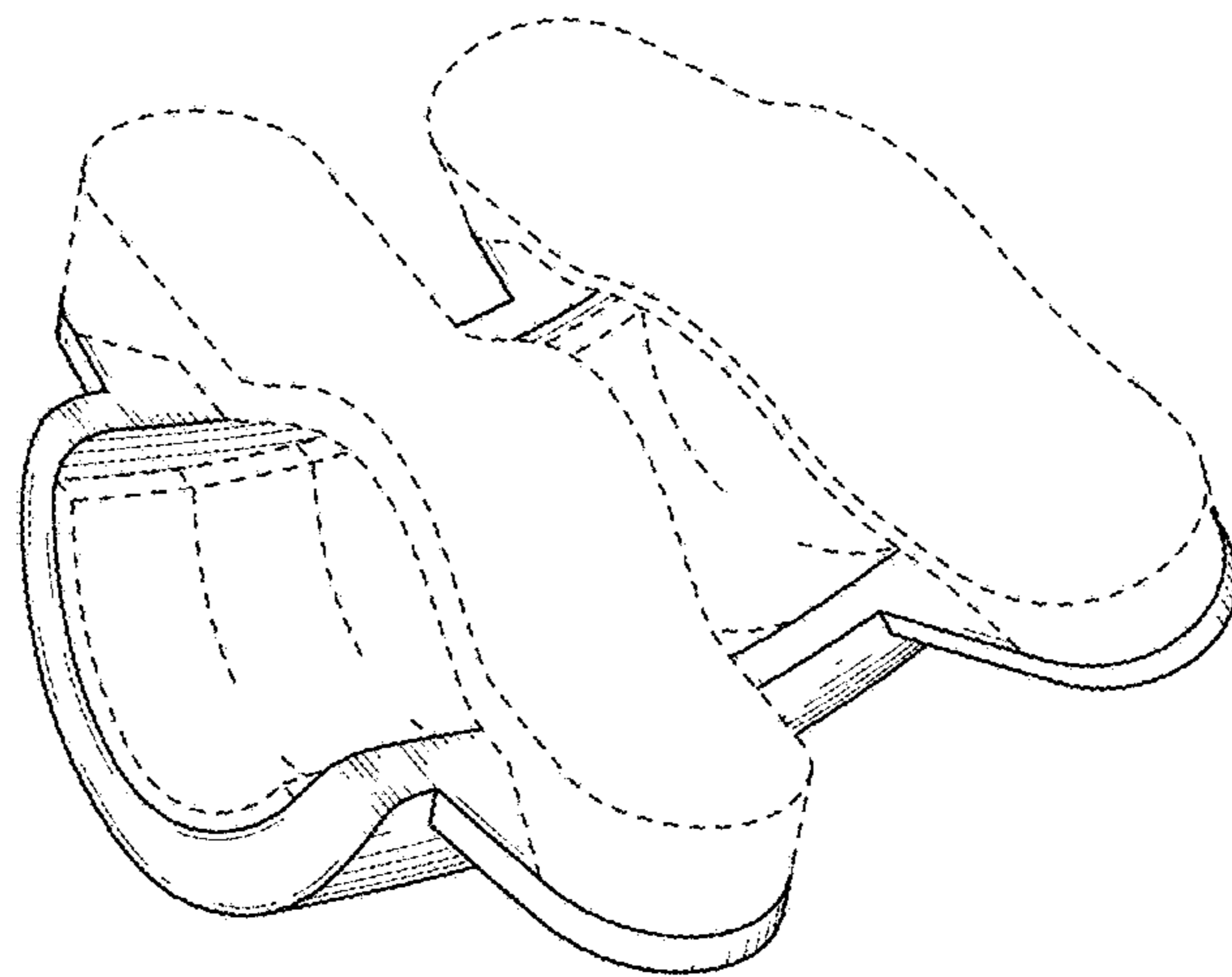

FIG. 6

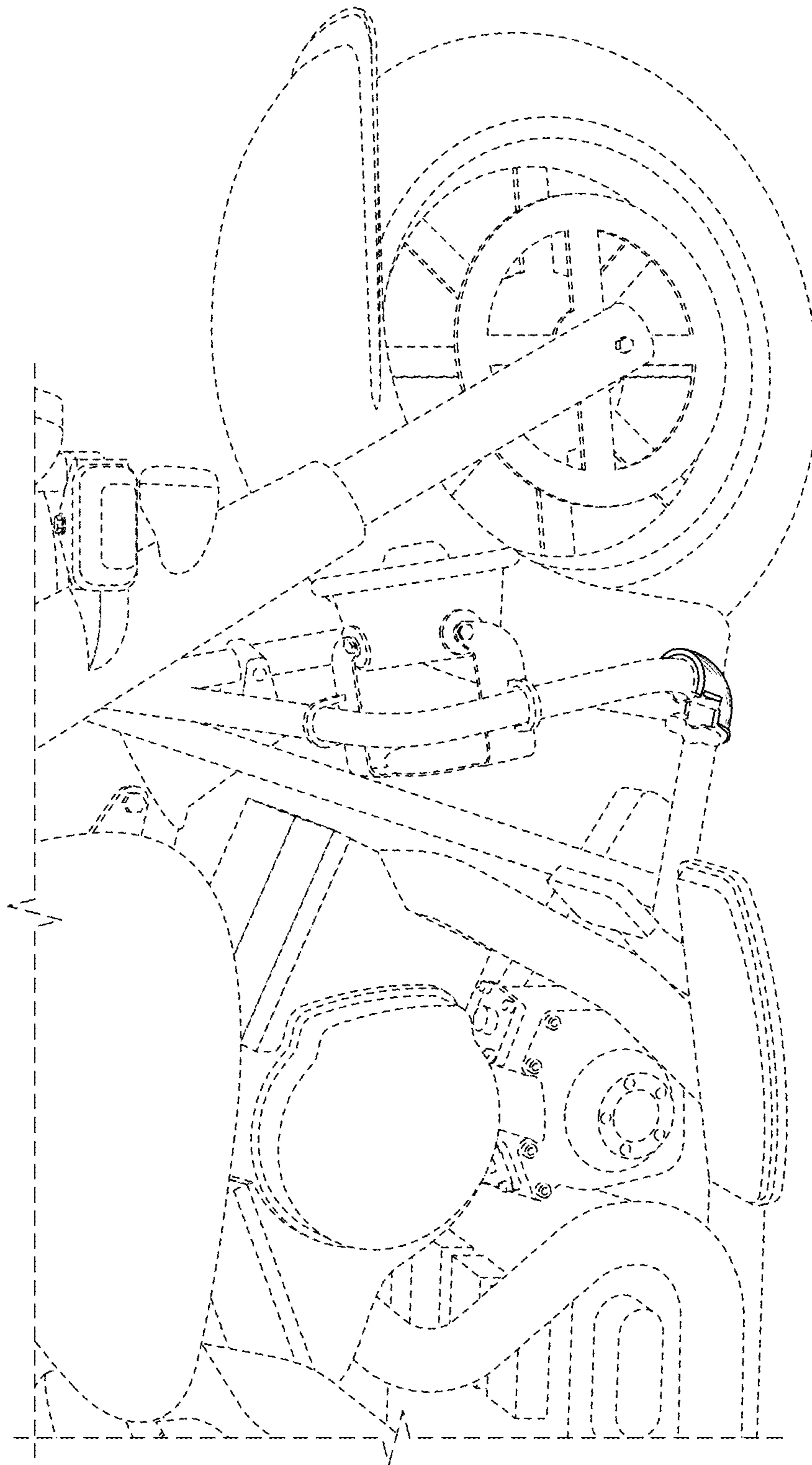

FIG. 7