



US00D774974S

(12) **United States Design Patent**  
**Greiner**

(10) **Patent No.:** **US D774,974 S**

(45) **Date of Patent:** **\*\* Dec. 27, 2016**

(54) **BICYCLE FRAME ELEMENT CONFIGURED TO RECEIVE AN ACCUMULATOR**

(71) Applicant: **Robert Bosch GmbH**, Stuttgart (DE)

(72) Inventor: **Rinaldo Greiner**, Reutlingen (DE)

(73) Assignee: **Robert Bosch GmbH**, Stuttgart (DE)

(\*\*) Term: **14 Years**

(21) Appl. No.: **29/526,101**

(22) Filed: **May 6, 2015**

(30) **Foreign Application Priority Data**

Nov. 7, 2014 (EM) ..... 002574186

(51) **LOC (10) Cl.** ..... **12-11**

(52) **U.S. Cl.**  
USPC ..... **D12/111; D12/114**

(58) **Field of Classification Search**  
USPC ..... D1/111, 117; D13/123-125, 133, 154;  
280/274-280, 281.1, 283-288,  
280/288.1-288.4; 361/271, 277,  
361/301.1-301.4, 328-330, 763; 438/171,  
438/190, 238, 239, 381, 386, 393, 396  
(Continued)

(56) **References Cited**

U.S. PATENT DOCUMENTS

D556,092 S \* 11/2007 Green ..... D12/108

D587,198 S \* 2/2009 Nagasawa ..... D13/125

(Continued)

*Primary Examiner* — Darlington Ly

(74) *Attorney, Agent, or Firm* — Maginot, Moore & Beck LLP

(57) **CLAIM**

The ornamental design for a bicycle frame element configured to receive an accumulator, as shown and described.

**DESCRIPTION**

Cross reference is made to copending U.S. design patent application Ser. No. 29/526,095 entitled “Bicycle Frame

Element with a Mounted Accumulator” by Greiner, which was filed on May 6, 2015; U.S. design patent application Ser. No. 29/526,100 entitled “Accumulator” by Greiner, which was filed on May 6, 2015; U.S. design patent application Ser. No. 29/526,103 entitled “Bicycle Frame Element Configured to Receive an Accumulator” by Greiner, which was filed on May 6, 2015; U.S. design patent application Ser. No. 29/526,106 entitled “Bicycle Frame Element Configured to Receive an Accumulator” by Greiner, which was filed on May 6, 2015; U.S. design patent application Ser. No. 29/526,112 entitled “Bicycle Frame Element Configured to Receive an Accumulator” by Greiner, which was filed on May 6, 2015; U.S. design patent application Ser. No. 29/526,115 entitled “Bicycle Frame Element Configured to Receive an Accumulator” by Greiner, which was filed on May 6, 2015; U.S. design patent application Ser. No. 29/526,119 entitled “Bicycle Frame Element Configured to Receive an Accumulator” by Greiner, which was filed on May 6, 2015; U.S. design patent application Ser. No. 29/526,126 entitled “Bicycle Frame Element Configured to Receive an Accumulator” by Greiner, which was filed on May 6, 2015; and U.S. design patent application Ser. No. 29/526,130 entitled “Bicycle Frame Element Configured to Receive an Accumulator” by Greiner, which was filed on May 6, 2015.

FIG. 1 is a perspective view of a bicycle frame element configured to receive an accumulator showing my new design;

FIG. 2 is a right side elevational view showing the design for the bicycle frame element configured to receive an accumulator of FIG. 1;

FIG. 3 is a left side elevational view showing the design for the bicycle frame element configured to receive an accumulator of FIG. 1;

FIG. 4 is a front elevational view showing the design for the bicycle frame element configured to receive an accumulator of FIG. 1;

FIG. 5 is a rear elevational view showing the design for the bicycle frame element configured to receive an accumulator of FIG. 1;

FIG. 6 is a top plan view showing the design for the bicycle frame element configured to receive an accumulator of FIG. 1; and,

(Continued)

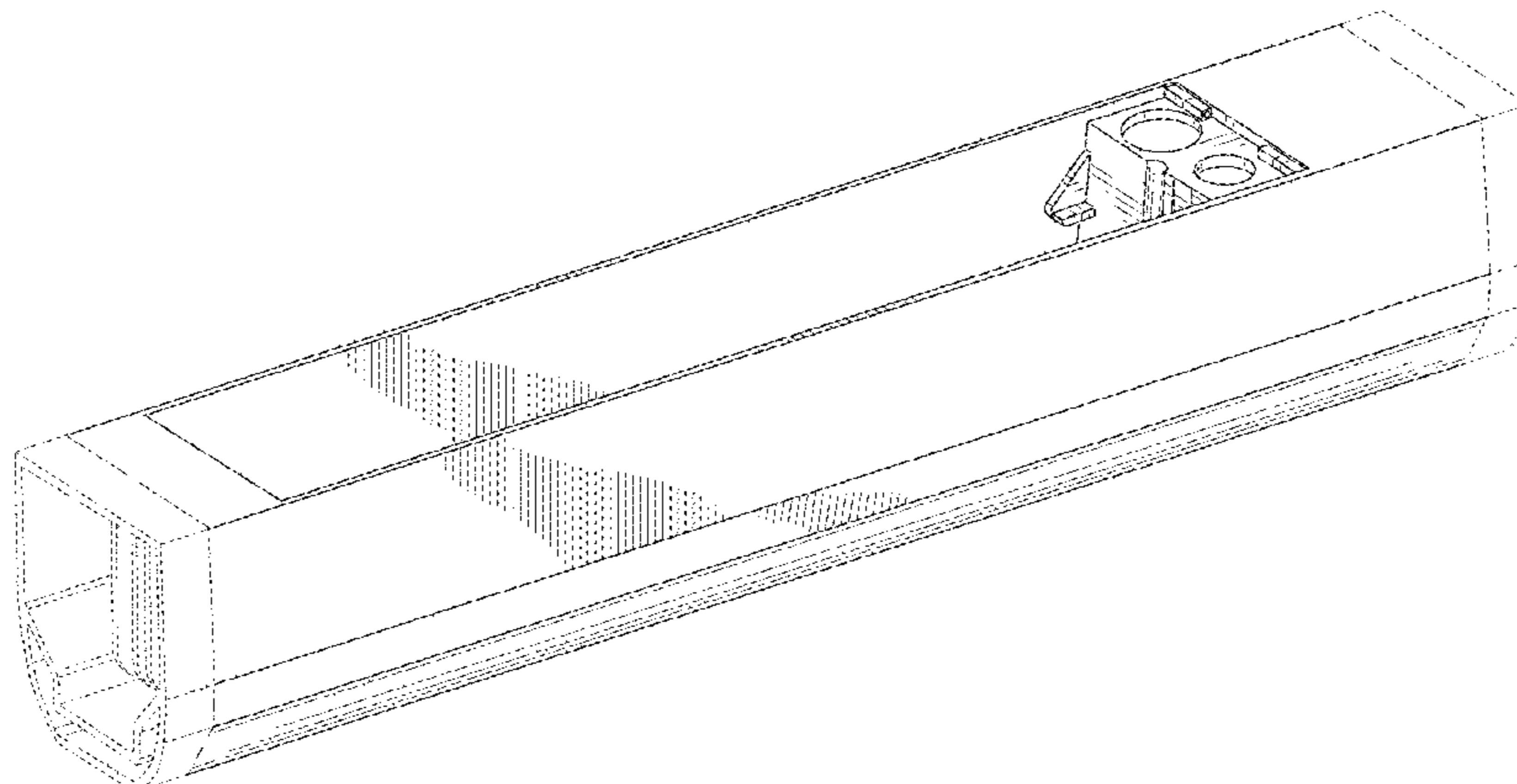

FIG. 7 is a bottom plan view showing the design for the bicycle frame element configured to receive an accumulator of FIG. 1.

The broken lines shown in the drawings illustrate portions of the bicycle frame element configured to receive an accumulator that form no part of the claimed design. The dash dot lines shown in FIGS. 1-3, 6, and 7 identify boundaries of the claimed design and form no part of the claimed design.

**1 Claim, 7 Drawing Sheets**

(58) **Field of Classification Search**

CPC ..... B62K 3/00; B62K 3/005; B62K 9/00;  
 B62K 19/00; B62K 19/02; B62K 19/04;  
 B62K 19/06; B62K 19/16; H01G 9/038;  
 H01G 9/155; H01G 11/26; H01G 11/58;  
 H01G 11/62; H01M 2/0245; Y02E 60/12;  
 Y02E 60/13

See application file for complete search history.

(56)

**References Cited**

U.S. PATENT DOCUMENTS

D590,750	S	*	4/2009	Hays	.....	D12/111
D619,935	S	*	7/2010	Lee	.....	D12/111
D637,526	S	*	5/2011	Choi	.....	D12/111
D712,835	S	*	9/2014	Yasuda	.....	D13/125
2004/0075420	A1	*	4/2004	Uno	.....	H02J 7/1407 322/1
2011/0042156	A1	*	2/2011	Vincenz	.....	B62H 5/001 180/206.5
2014/0035356	A1	*	2/2014	Watarai	.....	B60L 7/12 307/9.1
2014/0210318	A1	*	7/2014	Yao	.....	H02K 7/14 310/67 R
2014/0329134	A1	*	11/2014	Lang	.....	B62M 6/90 429/156
2015/0191215	A1	*	7/2015	Kawakami	.....	B62M 6/55 477/4

\* cited by examiner

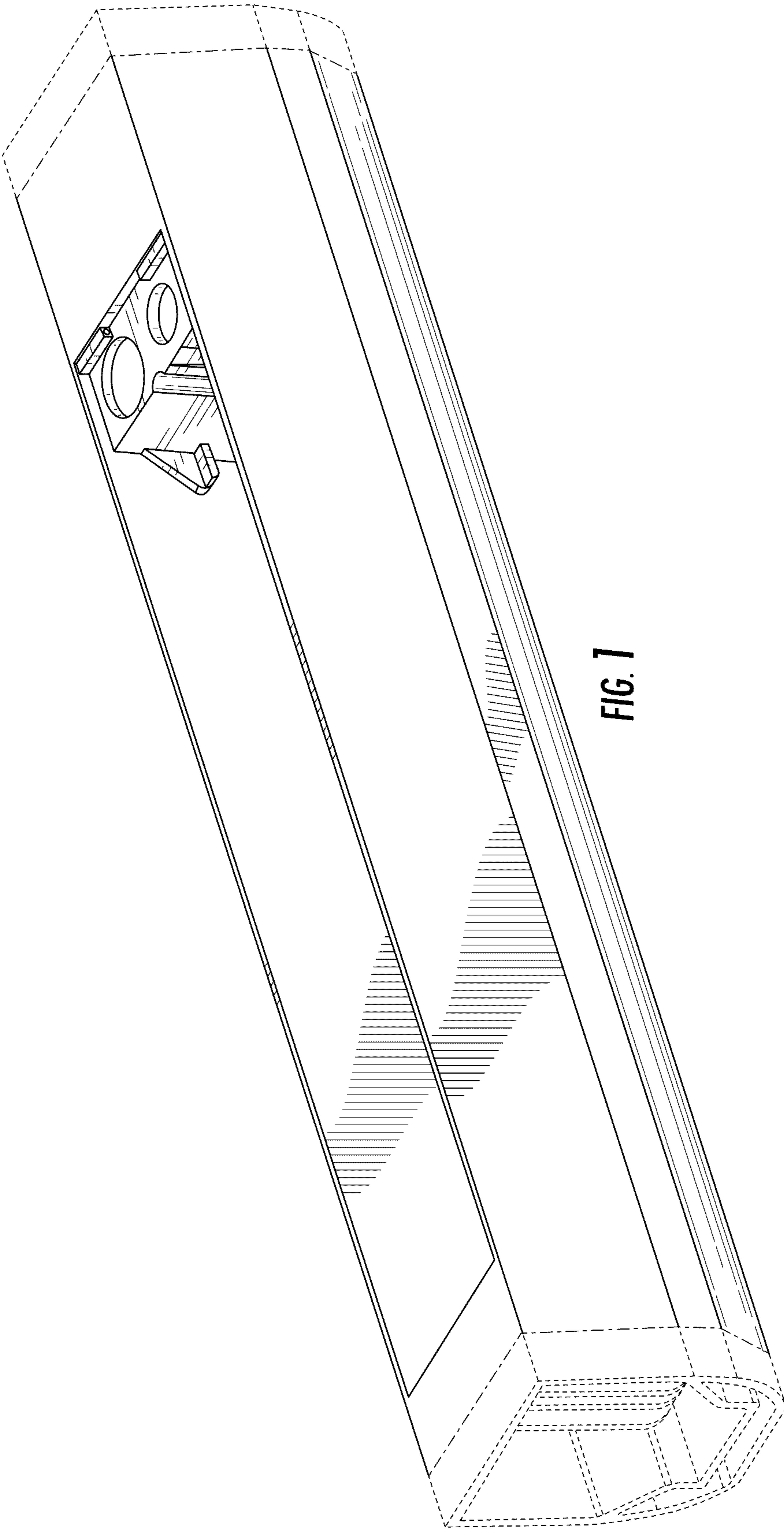

FIG. 1

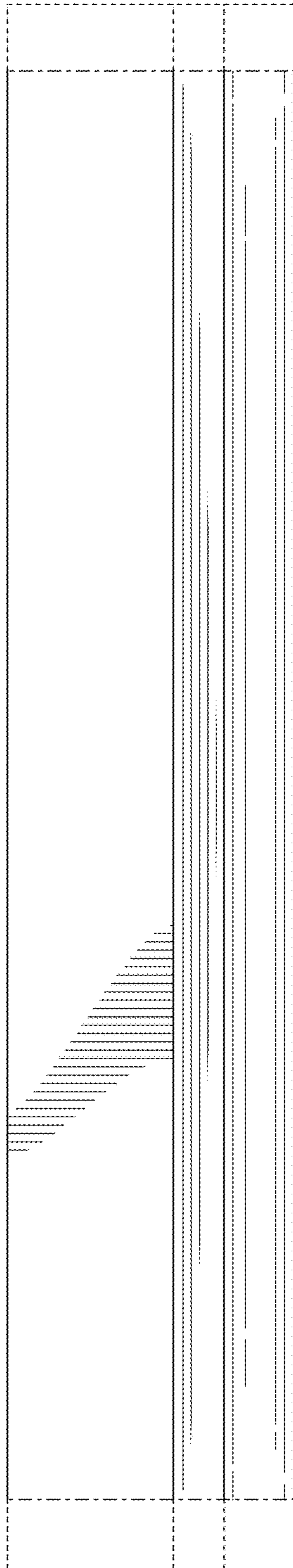

FIG. 2



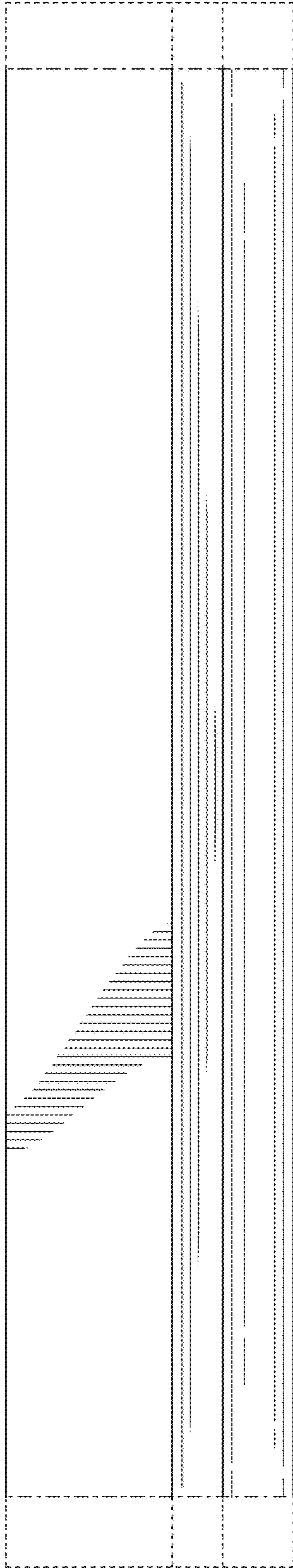
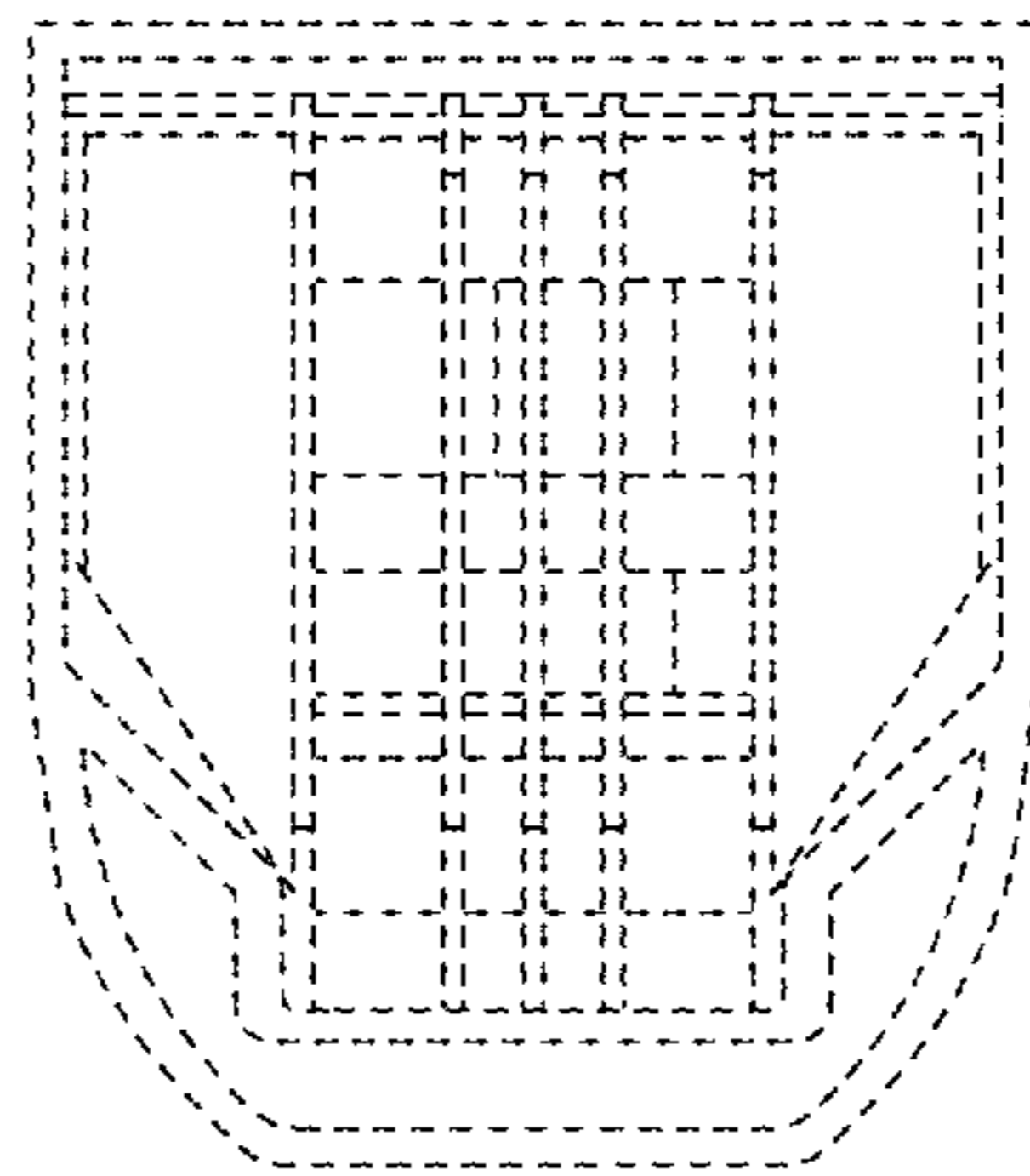
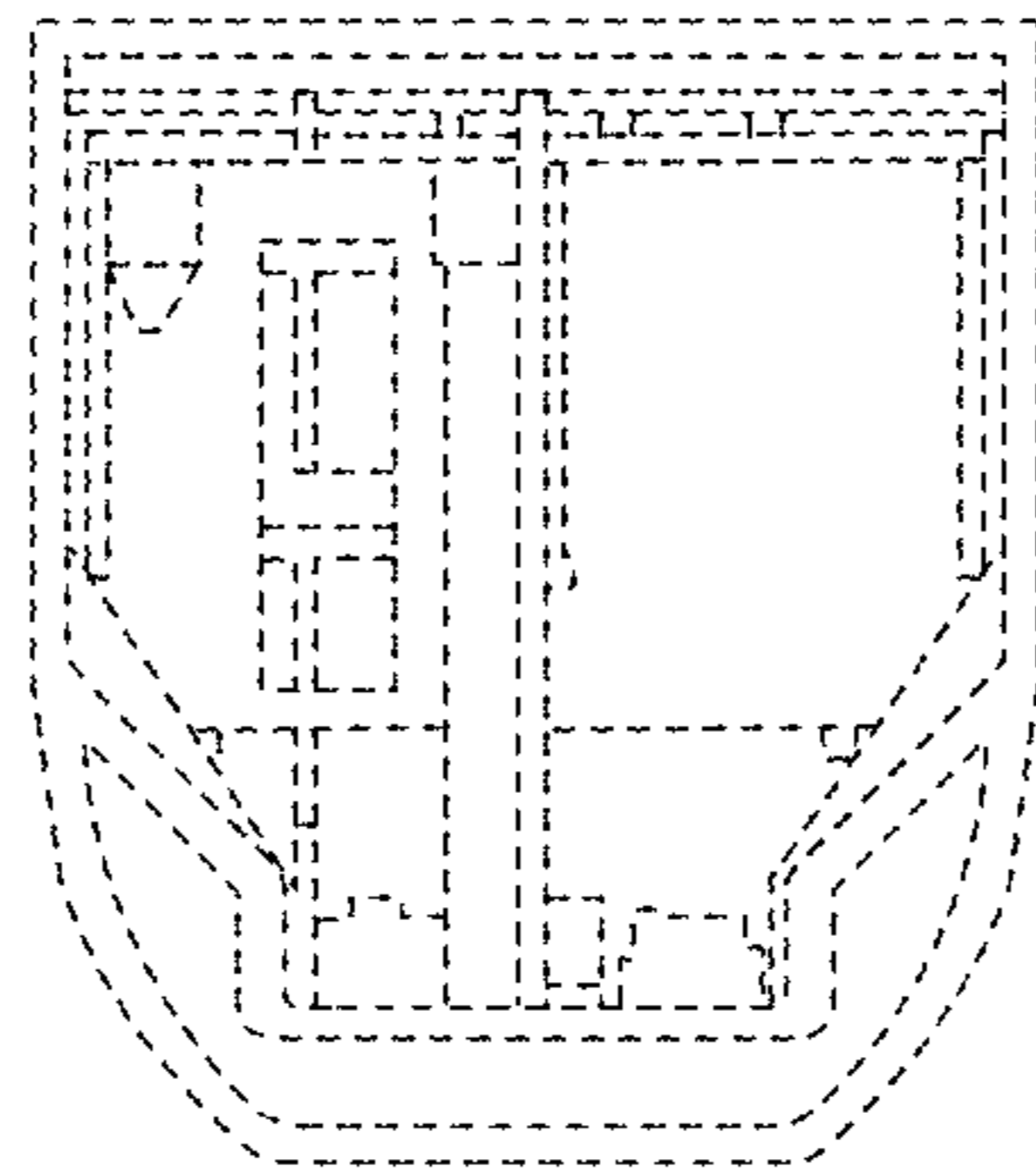

FIG. 3



**FIG. 4**



**FIG. 5**

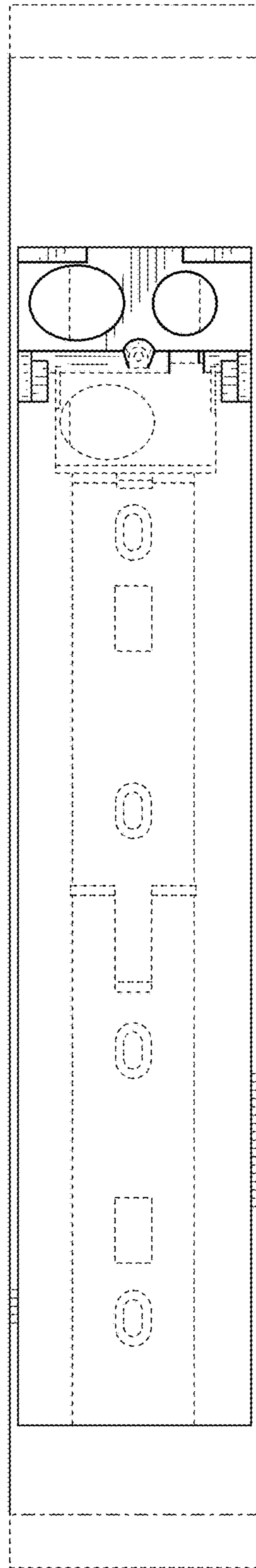

FIG. 6



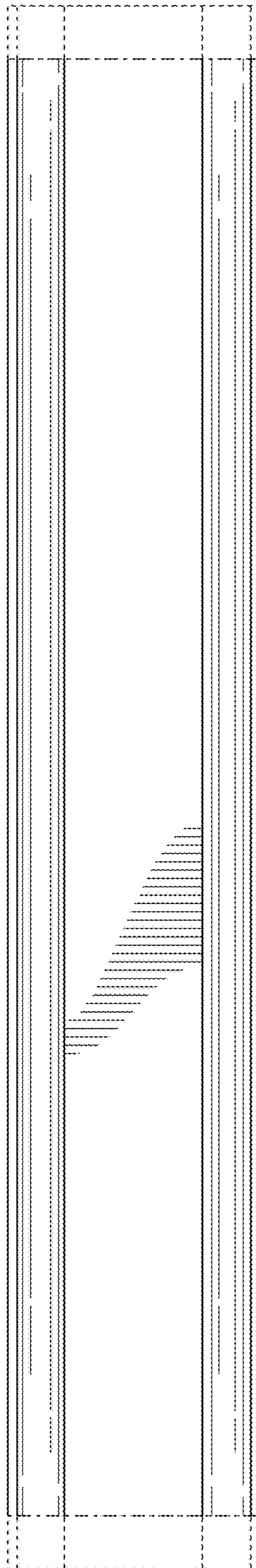

FIG. 7