



US00D774890S

(12) **United States Design Patent** (10) **Patent No.:** **US D774,890 S**
Mongeon et al. (45) **Date of Patent:** **** Dec. 27, 2016**

(54) **PACKAGE**

(71) Applicant: **The Procter & Gamble Company**,
Cincinnati, OH (US)
(72) Inventors: **Murphy Greene Mongeon**, Cincinnati,
OH (US); **Richard Lee Lane**,
Cincinnati, OH (US); **Marcus Paul
McDuffie**, Cincinnati, OH (US); **Jose
Juan Fuentes, Jr.**, West Chester, OH
(US)
(73) Assignee: **The Procter & Gamble Company**,
Cincinnati, OH (US)

(**) Term: **14 Years**

(21) Appl. No.: **29/506,478**

(22) Filed: **Oct. 16, 2014**

(51) **LOC (10) Cl.** **09-03**

(52) **U.S. Cl.**
USPC **D9/418**

(58) **Field of Classification Search**
USPC . D9/414-419, 499, 721; D6/517; 229/162.5;
132/314; 206/349

(Continued)

(56) **References Cited**

U.S. PATENT DOCUMENTS

D129,731 S * 9/1941 Luttrell D9/418
2,854,181 A 9/1958 Smith

(Continued)

OTHER PUBLICATIONS

U.S. Appl. No. 14/515,717, filed Oct. 16, 2014, Mongeon, et al.
Packaging sold in the US, May 2014. Package enclosed.
Commercially available Packaging sold in the US, Feb. 2015.

Primary Examiner — Rhea Shields

(74) *Attorney, Agent, or Firm* — Larry L. Huston; Steven
W. Miller

(57) **CLAIM**

The ornamental design for a package, as shown and
described.

DESCRIPTION

FIG. 1 is a perspective view of a first embodiment of the
package, showing our new design;
FIG. 2 is a front view of the package of FIG. 1;
FIG. 3 is a back view of the package of FIG. 1;
FIG. 4 is a side view of the package FIG. 1;
FIG. 5 is a side view of the package of FIG. 1, opposite the
side view shown in FIG. 4;
FIG. 6 is a top view of the package of FIG. 1; and
FIG. 7 is a bottom view of the package of FIG. 1;
FIG. 8 is a perspective view of a second embodiment of the
package, showing our new design;
FIG. 9 is a front view of the package of FIG. 8;
FIG. 10 is a back view of the package of FIG. 8;
FIG. 11 is a side view of the package of FIG. 8;
FIG. 12 is a side view of the package of FIG. 8, opposite the
side view shown in FIG. 11;
FIG. 13 is a top view of the package of FIG. 8; and
FIG. 14 is a bottom view of the package of FIG. 8;
FIG. 15 is a perspective view of a third embodiment of the
package, showing our new design;
FIG. 16 is a front view of the package of FIG. 15;
FIG. 17 is a back view of the package of FIG. 15;
FIG. 18 is a side view of the package of FIG. 15;
FIG. 19 is a side view of the package of FIG. 15, opposite
the side view shown in FIG. 18;
FIG. 20 is a top view of the package of FIG. 15; and
FIG. 21 is a bottom view of the package of FIG. 15;
FIG. 22 is a front view of a the facing of a package;
FIG. 23 is an alternative front view of a the facing of a
package; and,
FIG. 24 is an alternative front view of a the facing of a
package.
In FIGS. 8-12, 15-17 and 20-21; the package is shown with
a symbolic break in its width and length. The appearance of
any portion of the article beyond the break line forms no part

(Continued)

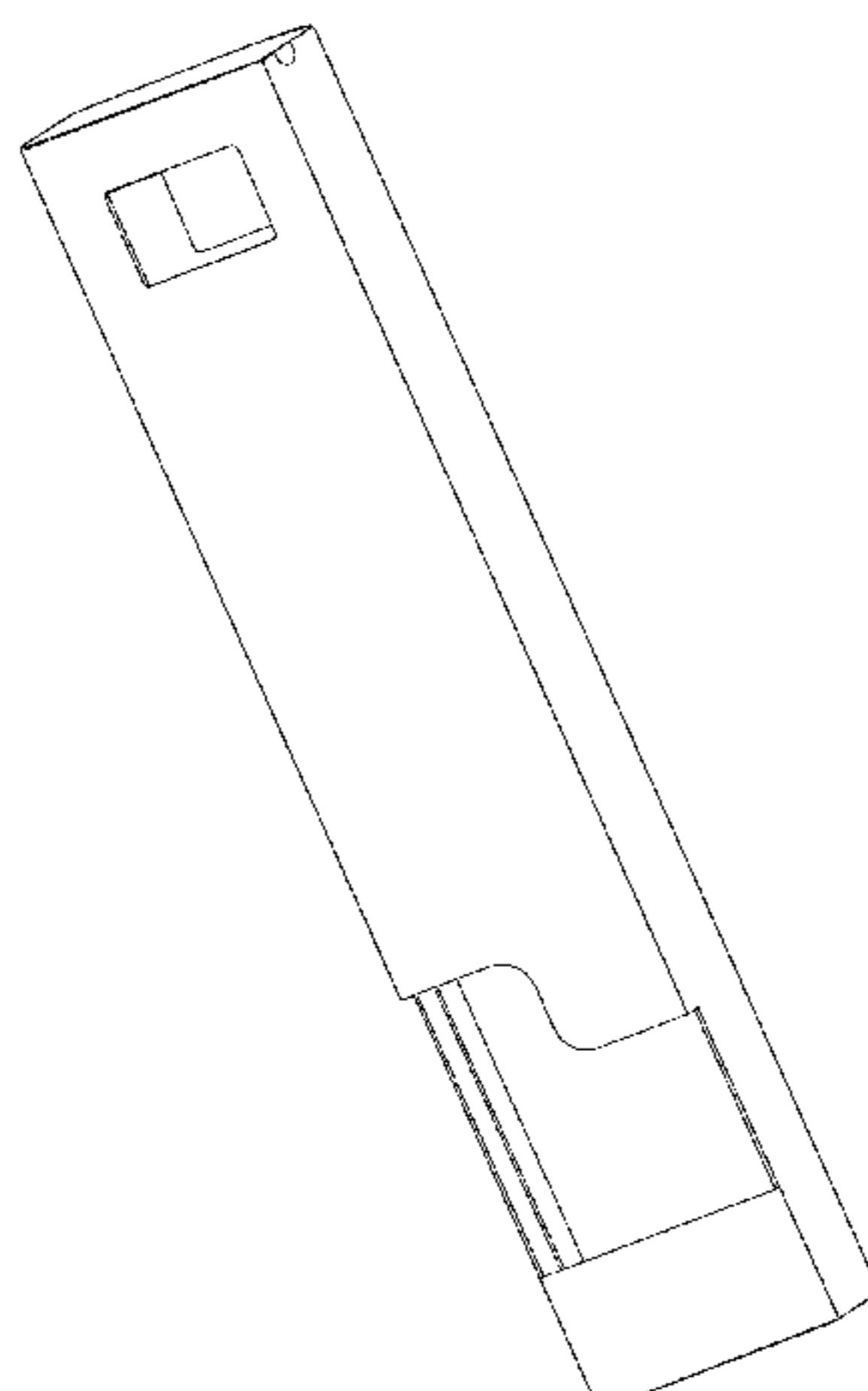

of the claimed design. In the drawings, the broken lines in the drawings represent unclaimed subject matter only and form no part of the claimed design.

1 Claim, 14 Drawing Sheets

(58) Field of Classification Search

CPC B65D 5/4204; B65D 77/22; B65D 5/5038;
B23Q 13/00

See application file for complete search history.

(56)

References Cited

U.S. PATENT DOCUMENTS

3,249,213 A * 5/1966 Palmer B65D 5/4204
229/162.5
D211,321 S * 6/1968 Ullmann D9/418
D224,692 S * 8/1972 Gray D6/517
D227,351 S * 6/1973 Winston D9/418

3,869,062 A 3/1975 Boyle et al.
4,177,917 A 12/1979 Webinger
4,326,546 A * 4/1982 Acker B65D 77/22
132/314
D332,744 S * 1/1993 McCooey D9/415
D349,458 S * 8/1994 Verdaguer D9/415
5,495,983 A 3/1996 Lelek
5,823,339 A * 10/1998 Dunham B65D 5/5038
206/349
5,850,916 A * 12/1998 Pettersson B23Q 13/00
206/349
D405,369 S * 2/1999 Dohner D9/415
5,971,265 A 10/1999 Collins
6,059,180 A 5/2000 Collins
D451,801 S * 12/2001 Schillinger D9/418
6,474,539 B1 11/2002 Van Der Horst
D685,260 S * 7/2013 Thielemier D9/415
D689,360 S * 9/2013 Adams D9/418
D699,563 S * 2/2014 McAdam D9/418
D710,713 S * 8/2014 Fath D9/721
D746,700 S * 1/2016 Boehnen D9/418
2013/0087476 A1 4/2013 Keefe

* cited by examiner

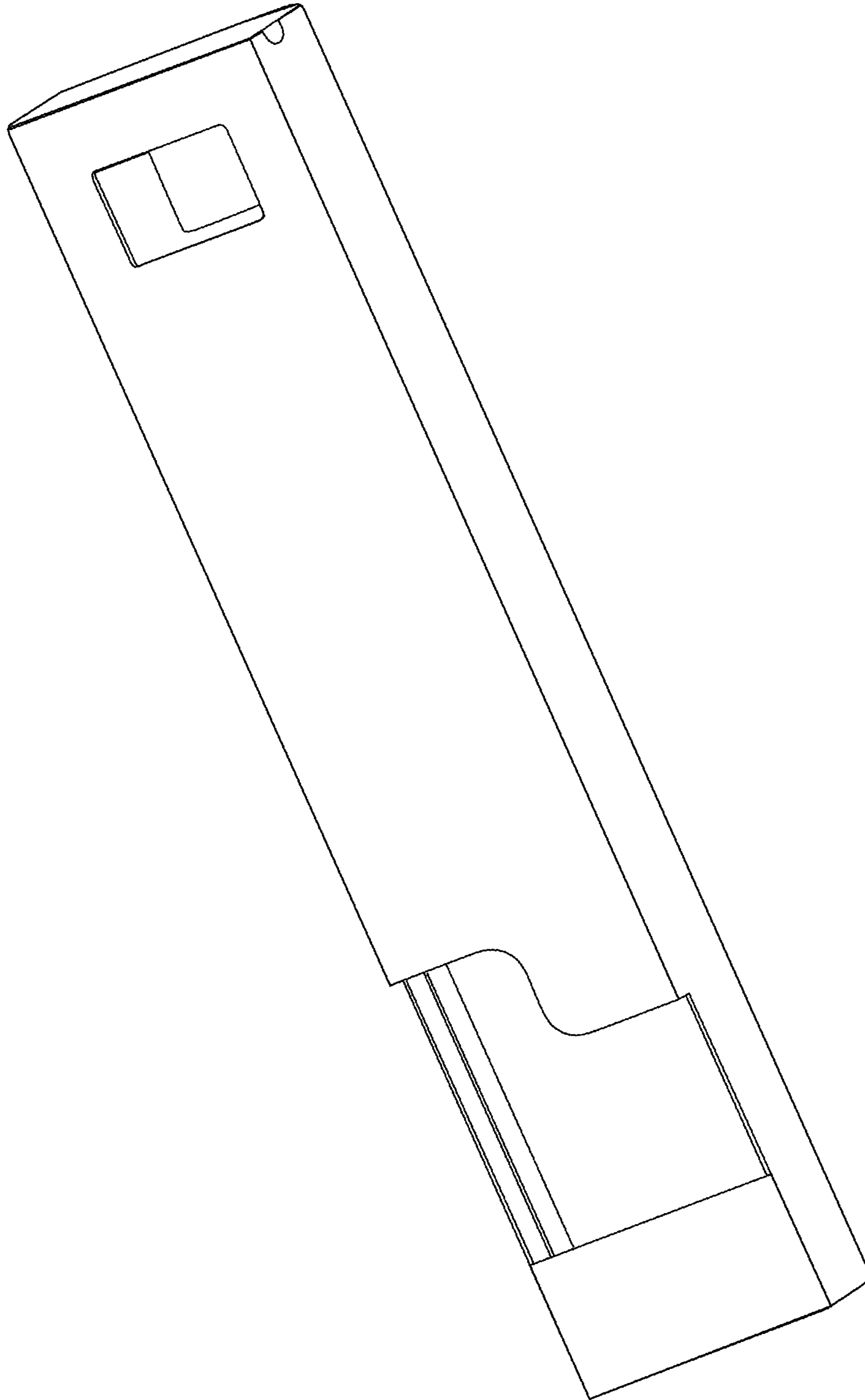

Fig. 1

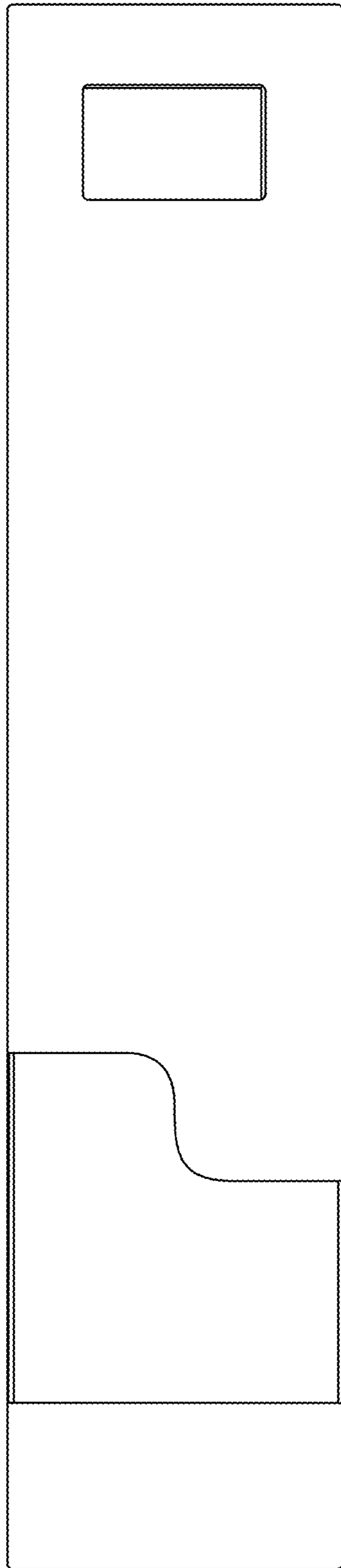

Fig. 2

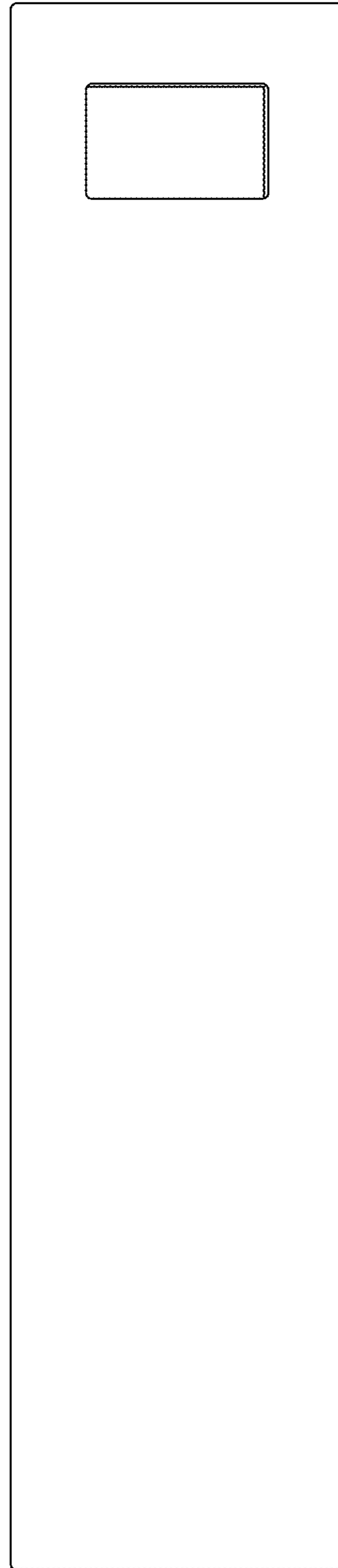

Fig. 3

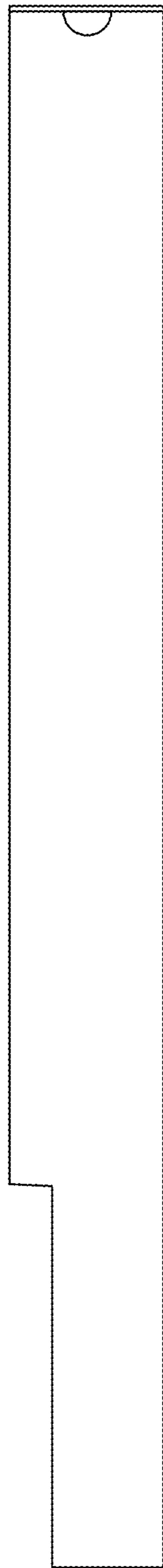

Fig. 4

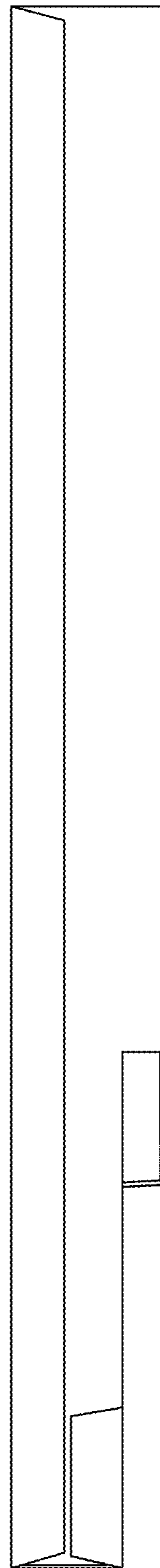

Fig. 5

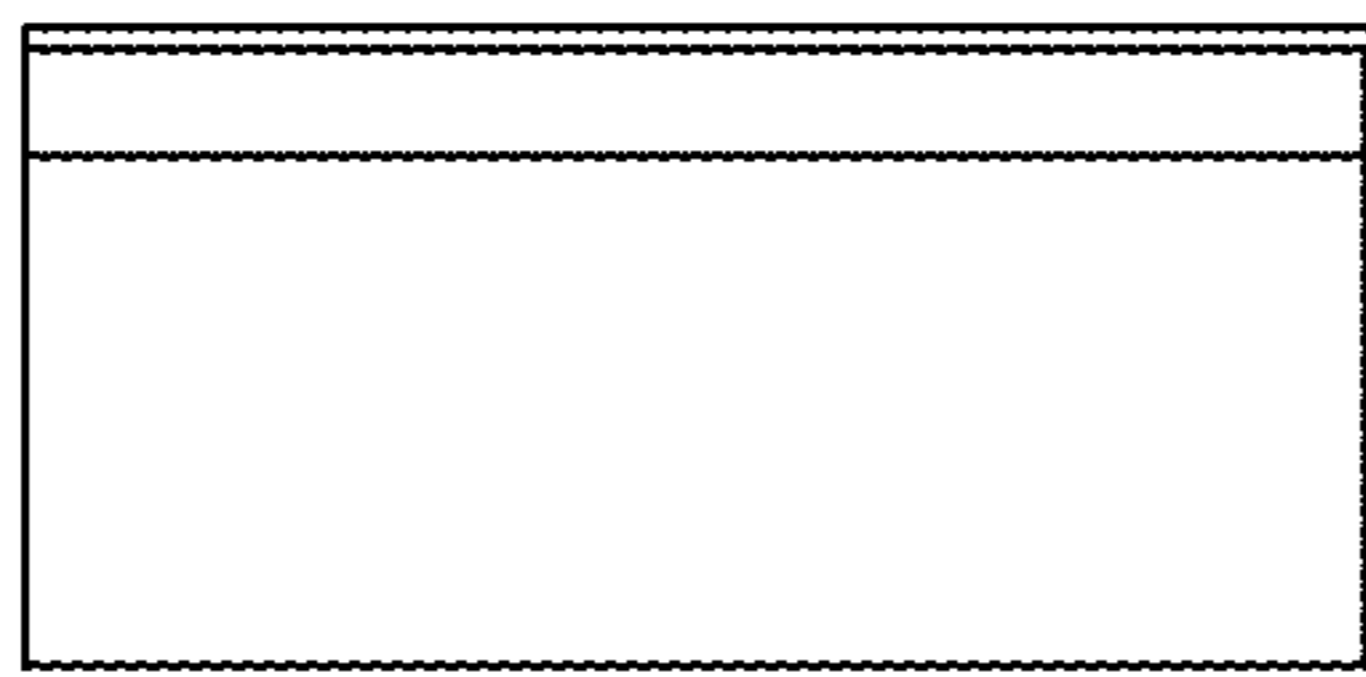

Fig. 6

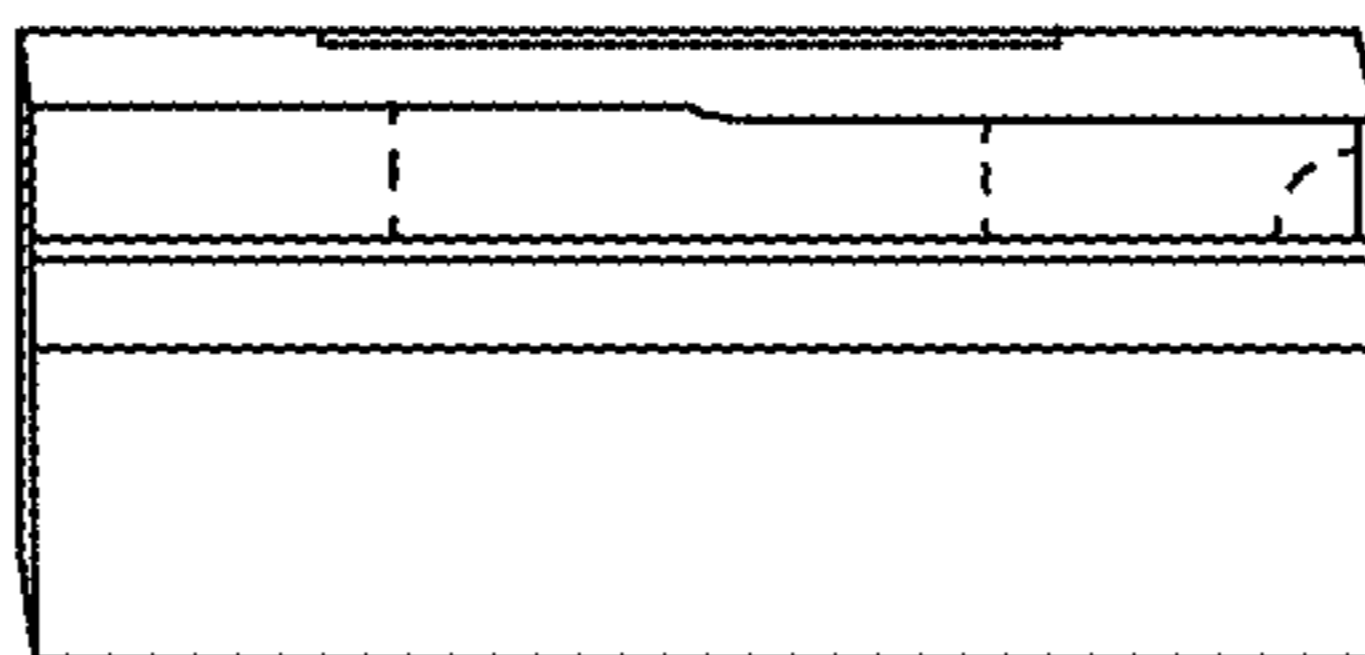

Fig. 7

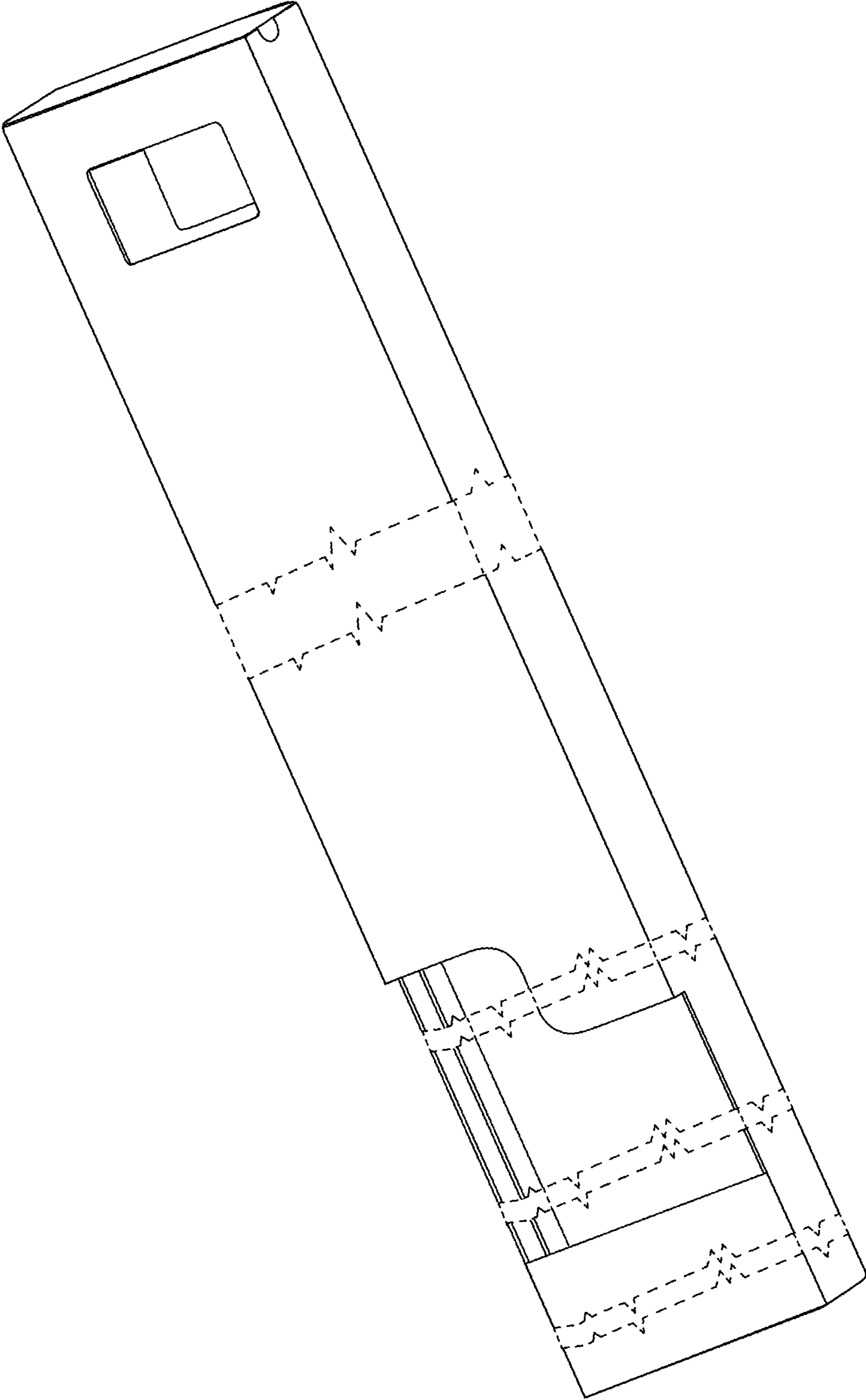

Fig. 8

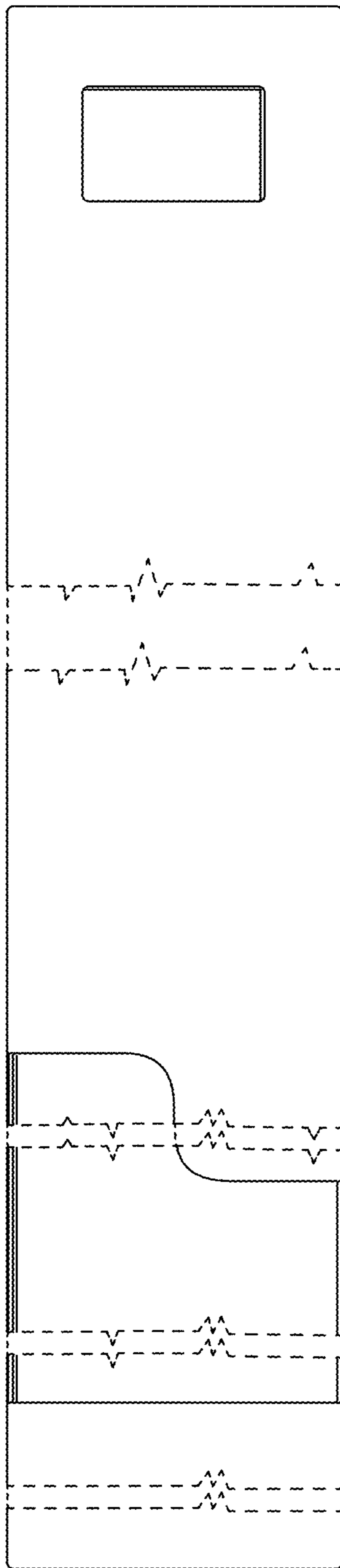

Fig. 9

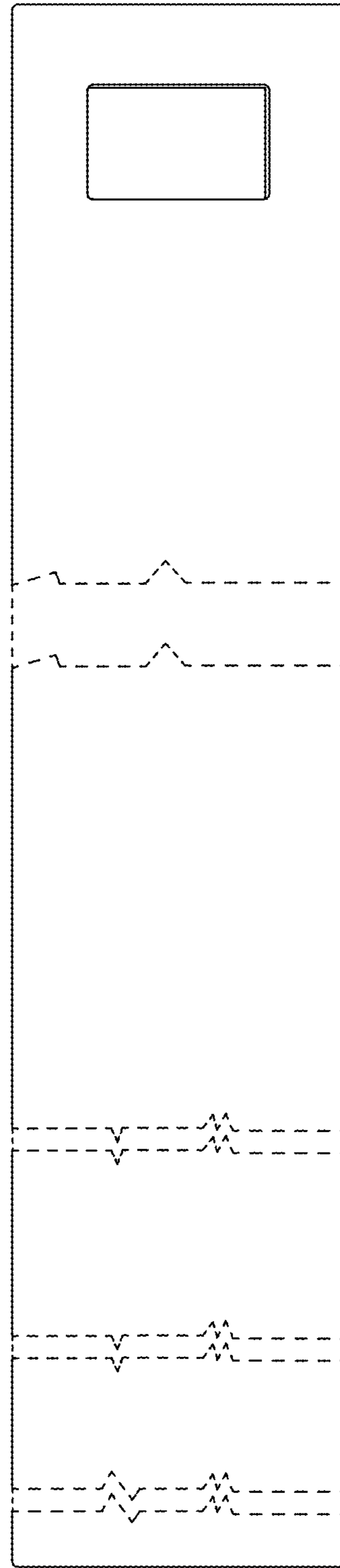

Fig. 10

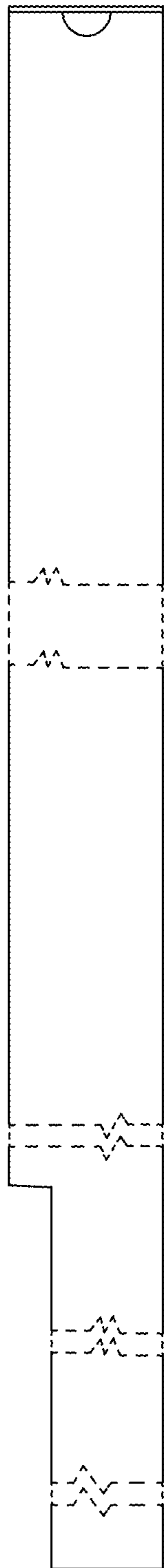

Fig. 11

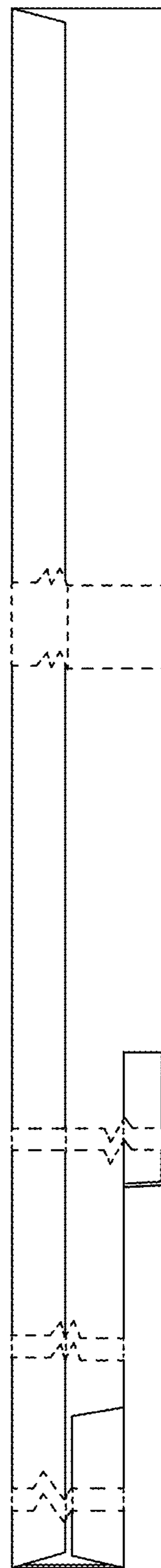

Fig. 12

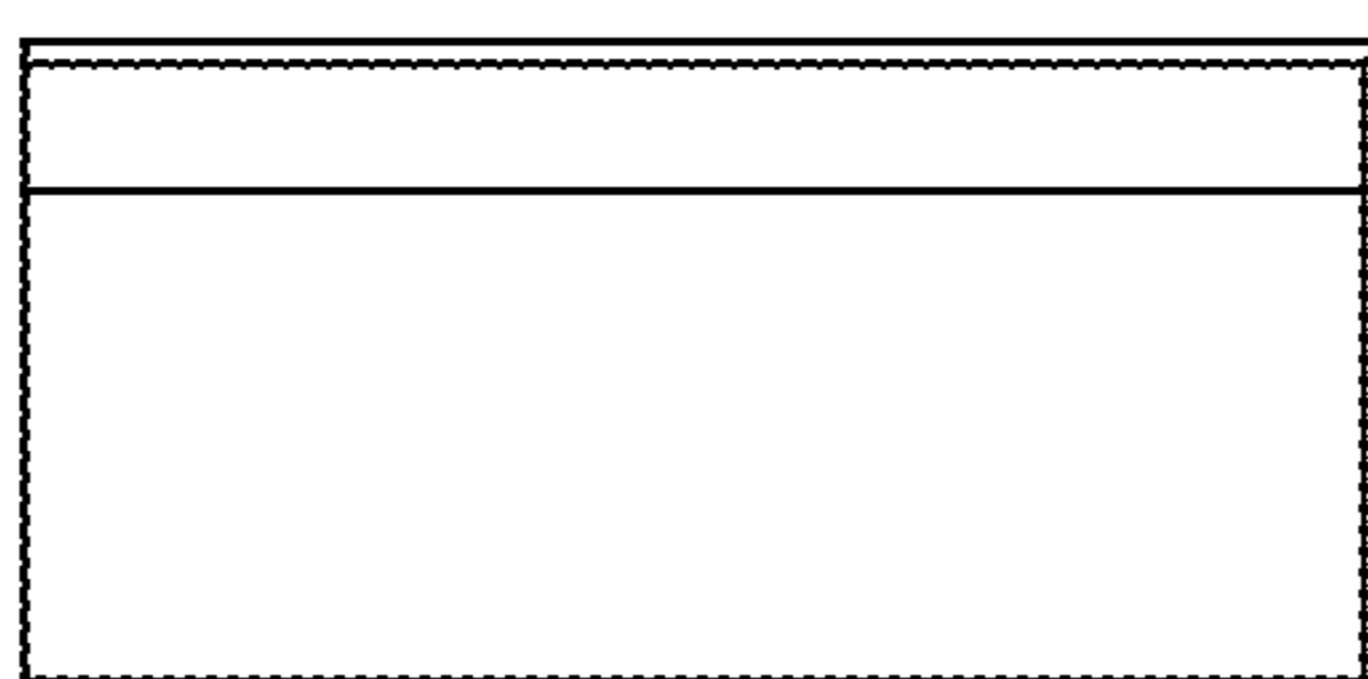

Fig. 13

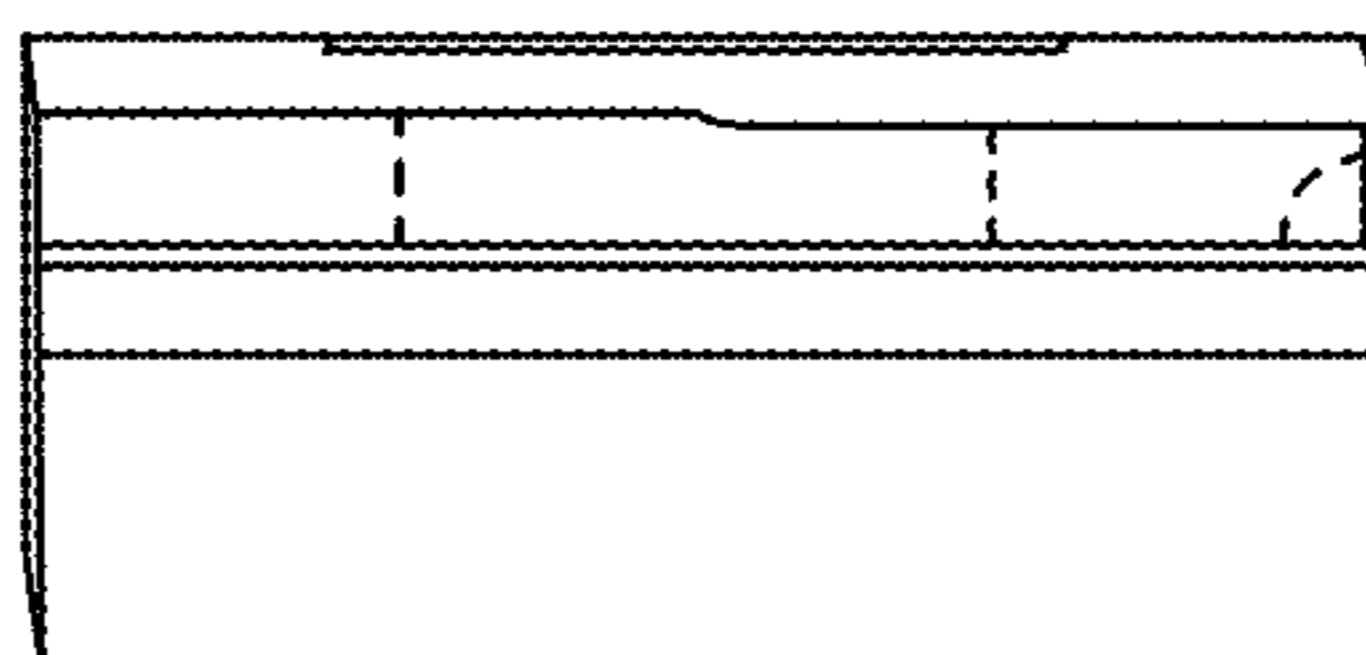

Fig. 14

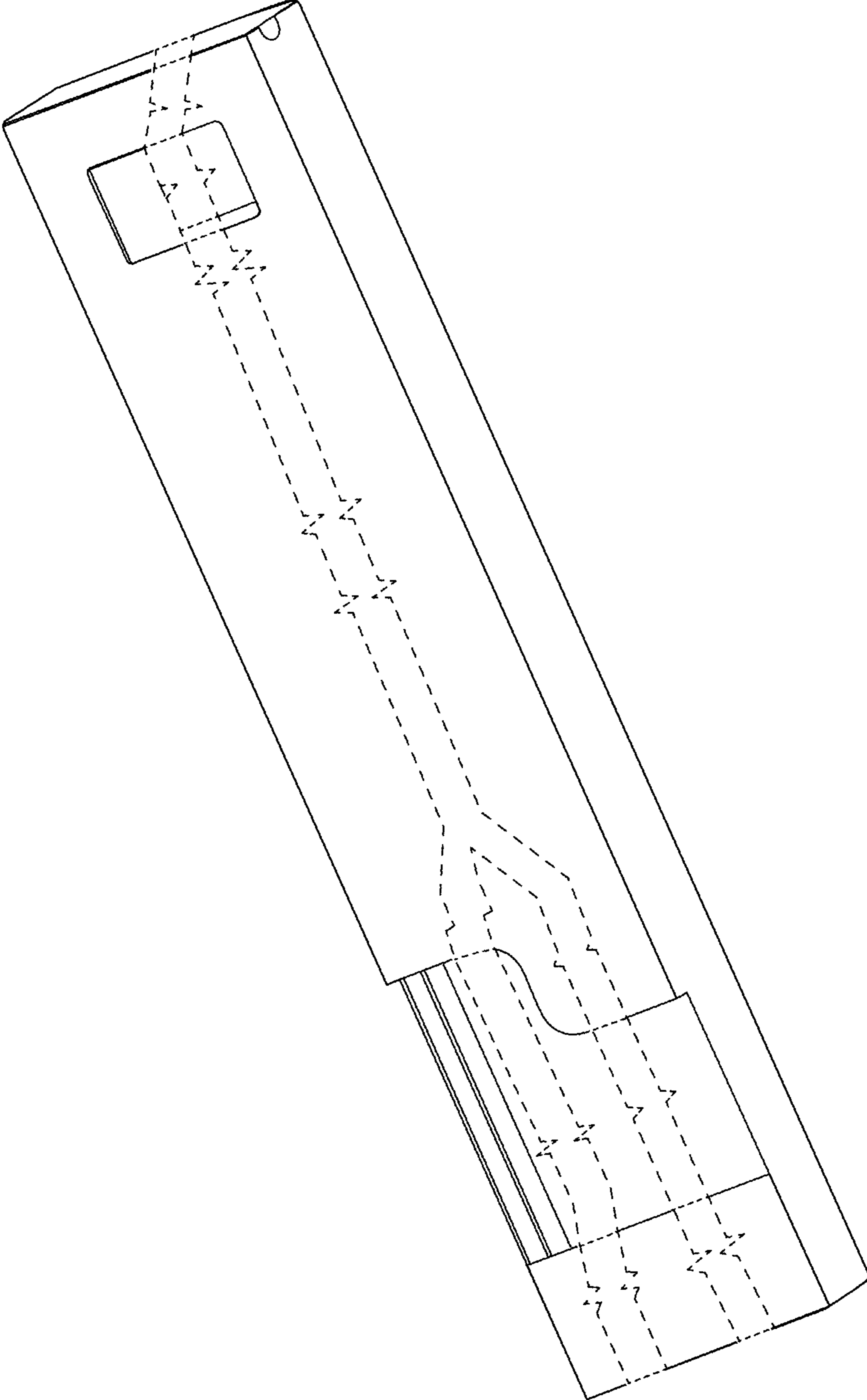

Fig. 15

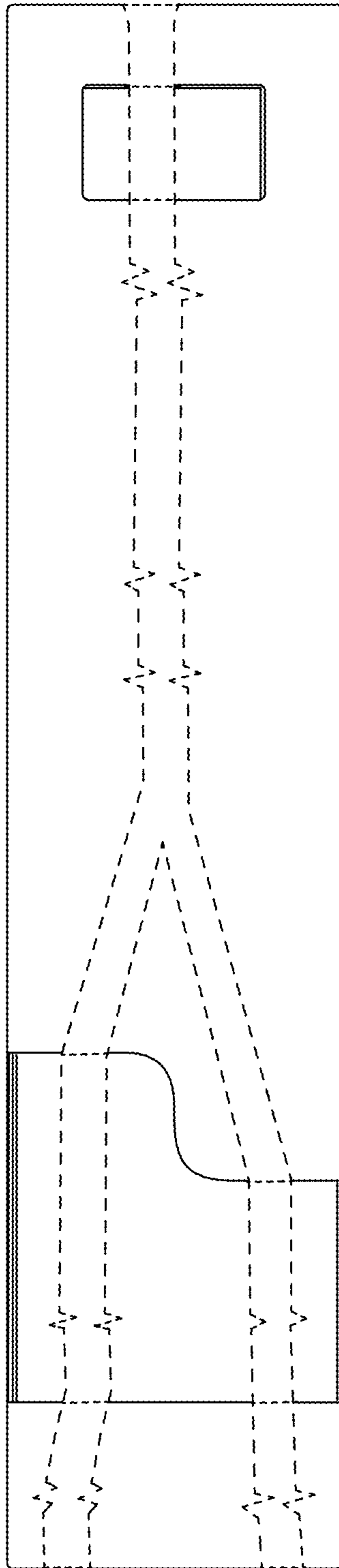

Fig. 16

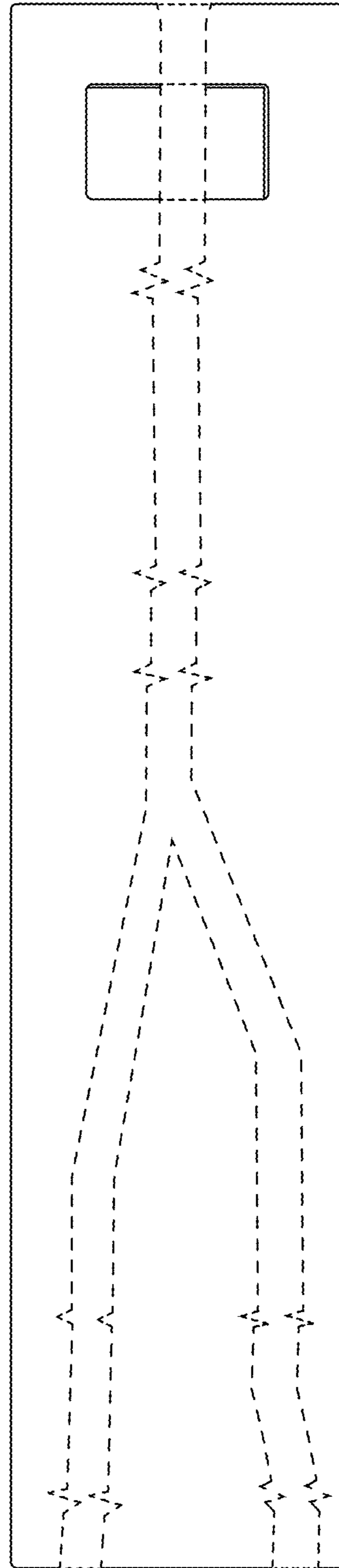

Fig. 17

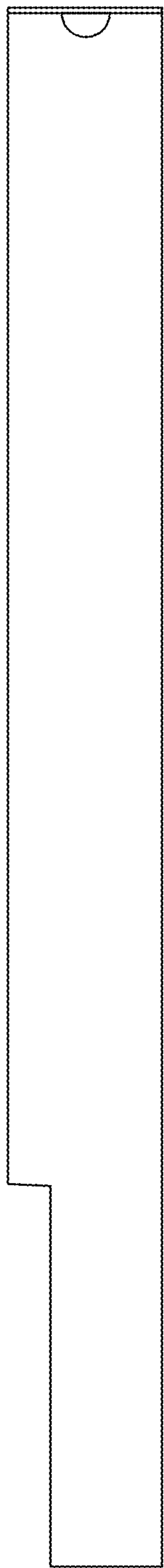

Fig. 18

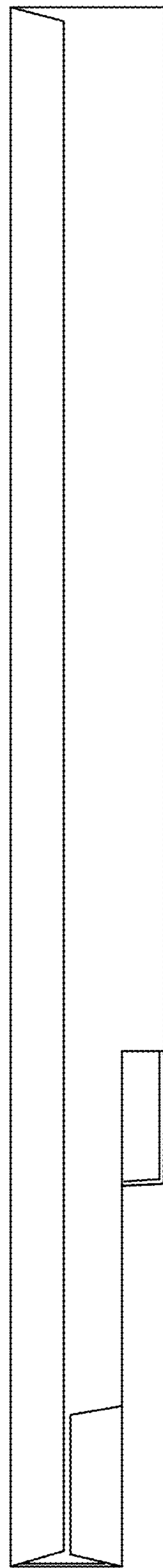

Fig. 19

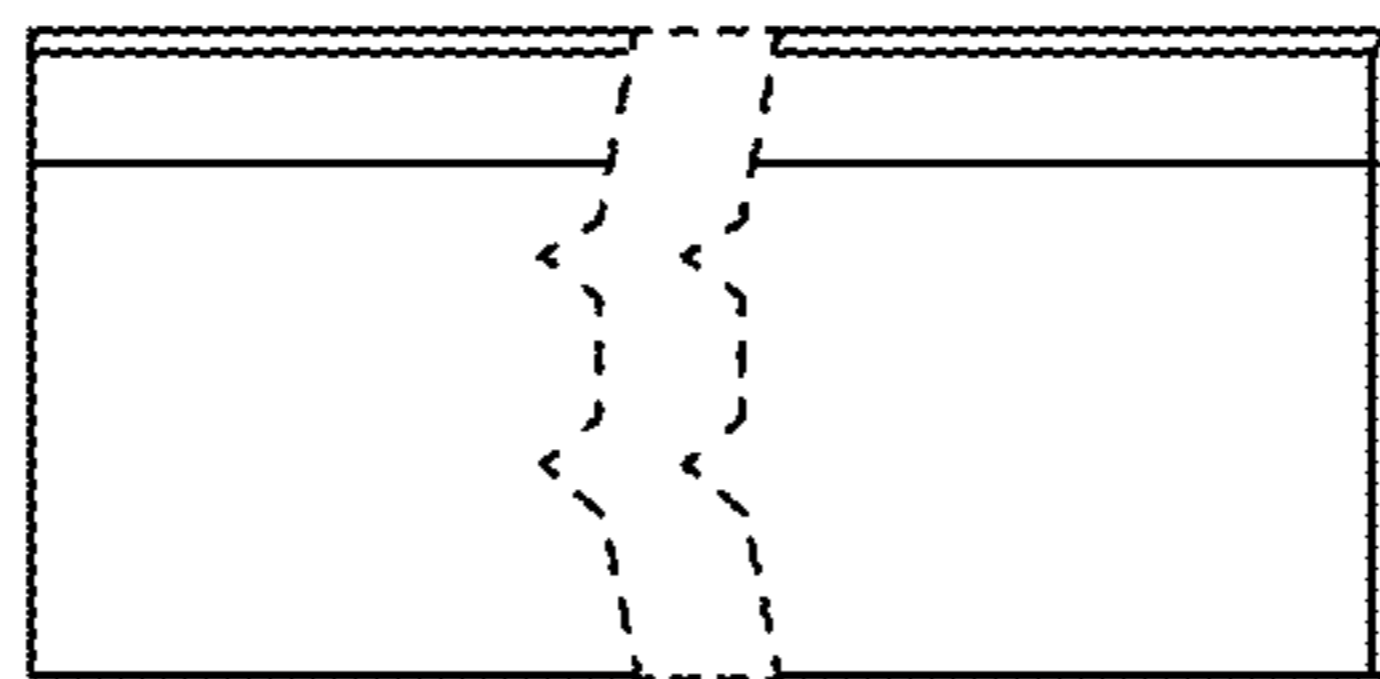

Fig. 20

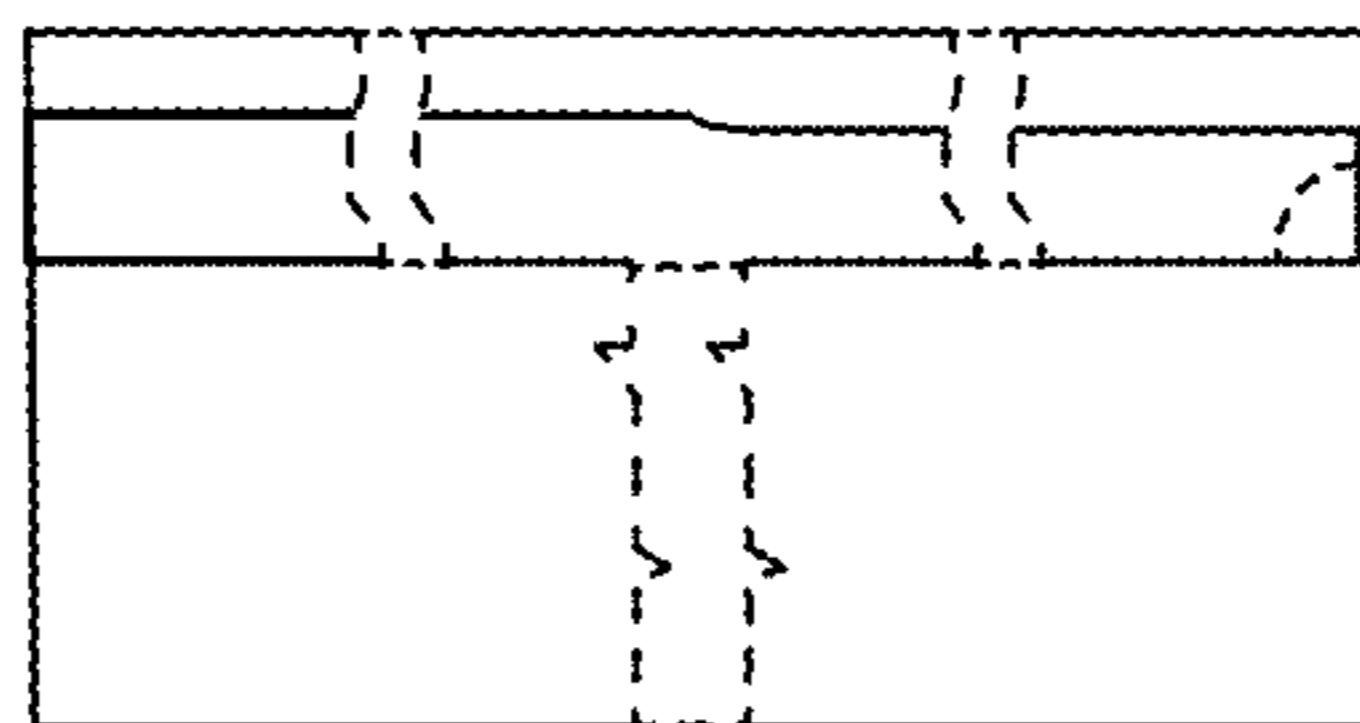

Fig. 21

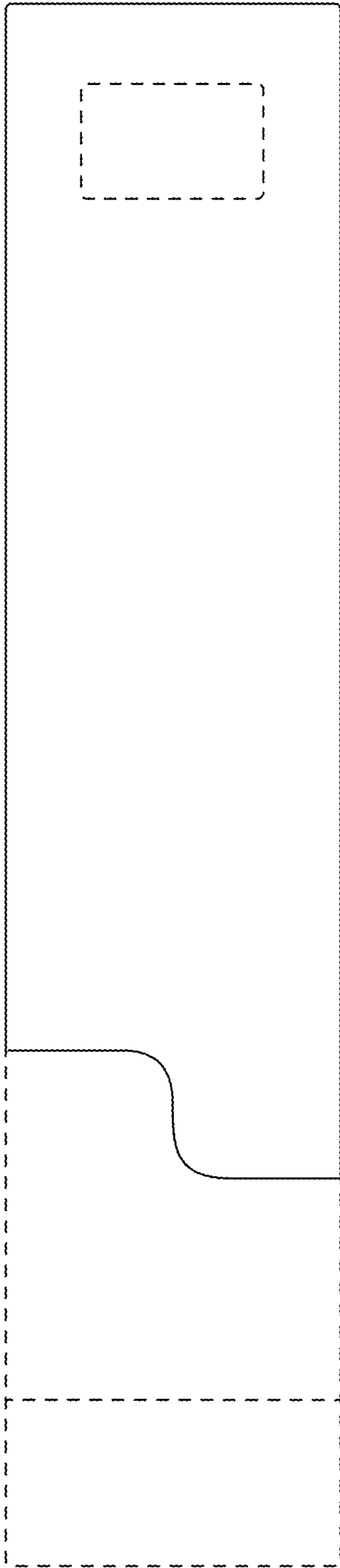

Fig. 22

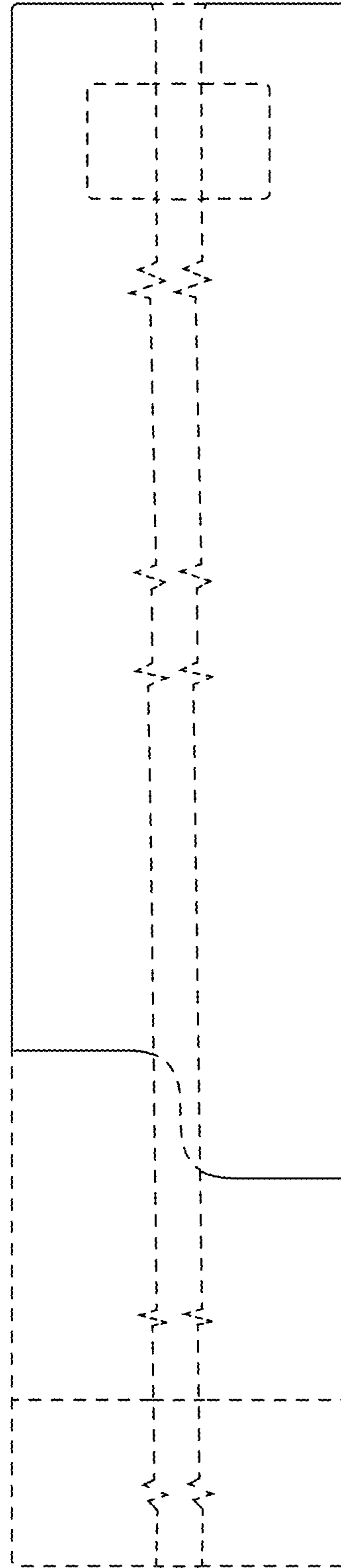

Fig. 23

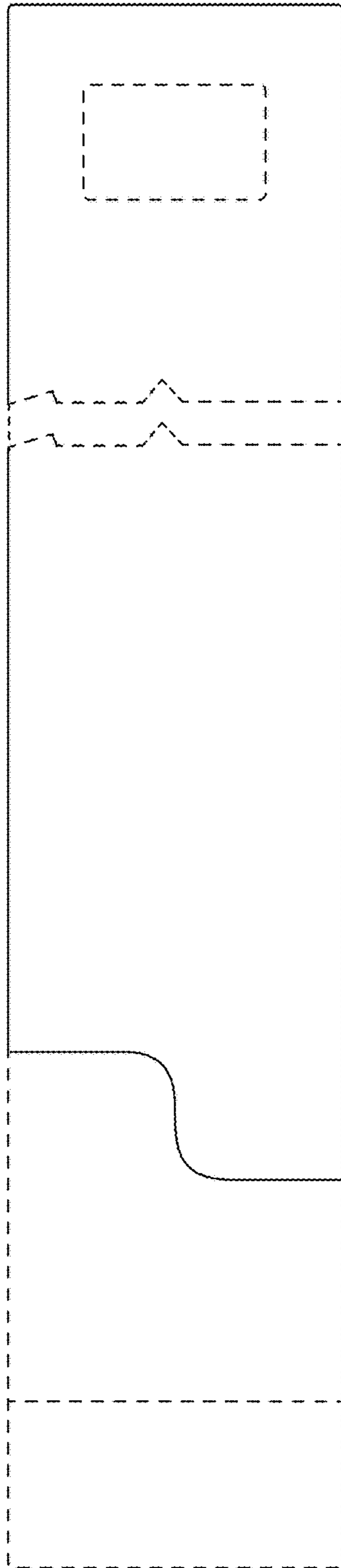

Fig. 24