



US00D774727S

(12) **United States Design Patent**  
**McCombs**

(10) **Patent No.:** **US D774,727 S**

(45) **Date of Patent:** **\*\* Dec. 27, 2016**

- (54) **SPLIT GROIN UNDERGARMENT**
- (71) Applicant: **Kelly McCombs**, Seattle, WA (US)
- (72) Inventor: **Kelly McCombs**, Seattle, WA (US)
- (\*\*) Term: **14 Years**
- (21) Appl. No.: **29/517,816**
- (22) Filed: **Feb. 17, 2015**

D746,544 S \* 1/2016 Curran ..... D2/738  
 D746,545 S \* 1/2016 Kositchiranant ..... D2/742  
 2007/0032771 A1\* 2/2007 Abed ..... A41B 9/001  
 604/385.22

(Continued)

**OTHER PUBLICATIONS**

<http://www.run247.com/articles/article-5137-breakthrough-compression-shorts-to-help-prevent-and-aid-management-of-common-sports-injury.html>—Published Jun. 13, 2014.\*

(Continued)

**Related U.S. Application Data**

- (63) Continuation of application No. 29/515,607, filed on Jan. 23, 2015.
- (51) **LOC (10) Cl.** ..... **02-01**
- (52) **U.S. Cl.**  
USPC ..... **D2/712**
- (58) **Field of Classification Search**  
USPC ..... D2/712, 713, 714, 715, 716, 731, 732, D2/736, 734, 735, 737, 738, 739, 742, D2/860, 863; D24/122, 124, 125, 126, D24/127, 128, 189, 215  
CPC ..... A41B 9/00; A41B 9/001; A41B 9/02; A41B 9/004; A41B 17/00; A41B 2500/50; A41B 1/08; A41B 9/04; A41B 13/04  
See application file for complete search history.

*Primary Examiner* — Manpreet Matharu

*Assistant Examiner* — Mojtaba Tehrani

(74) *Attorney, Agent, or Firm* — Michelle E. Carey; Telekta Law, P.S.

(57) **CLAIM**

The ornamental design for a split groin undergarment, as shown and described.

**DESCRIPTION**

FIG. 1 is an isometric view of a split groin undergarment in the closed configuration;  
 FIG. 2 is front view thereof;  
 FIG. 3 is a rear view thereof;  
 FIG. 4 is a right side view thereof;  
 FIG. 5 is a left side view thereof;  
 FIG. 6 is a top view thereof;  
 FIG. 7 is a bottom view thereof;  
 FIG. 8 is an isometric view of a split groin undergarment in the open configuration;  
 FIG. 9 is front view thereof;  
 FIG. 10 is a rear view thereof;  
 FIG. 11 is a right side view thereof;  
 FIG. 12 is a left side view thereof;  
 FIG. 13 is a top view thereof; and,  
 FIG. 14 is a bottom view thereof.  
 Solid lines with perpendicular elements represent stitching and form no part of the claimed design.

(56) **References Cited**

**U.S. PATENT DOCUMENTS**

- 2,190,425 A \* 2/1940 Hurd ..... A41B 9/02  
2/401
- 2,323,451 A \* 7/1943 Bullinger ..... A41B 9/04  
128/891
- 5,535,757 A \* 7/1996 Fleming, Jr. .... A61F 6/04  
128/842
- 7,087,032 B1 \* 8/2006 Ikeda ..... A61F 5/03  
128/891
- D687,617 S \* 8/2013 LaCour-Phillippi ..... D2/712
- D722,420 S \* 2/2015 Abrams ..... D2/712
- D722,742 S \* 2/2015 Abrams ..... D2/712

**1 Claim, 13 Drawing Sheets**

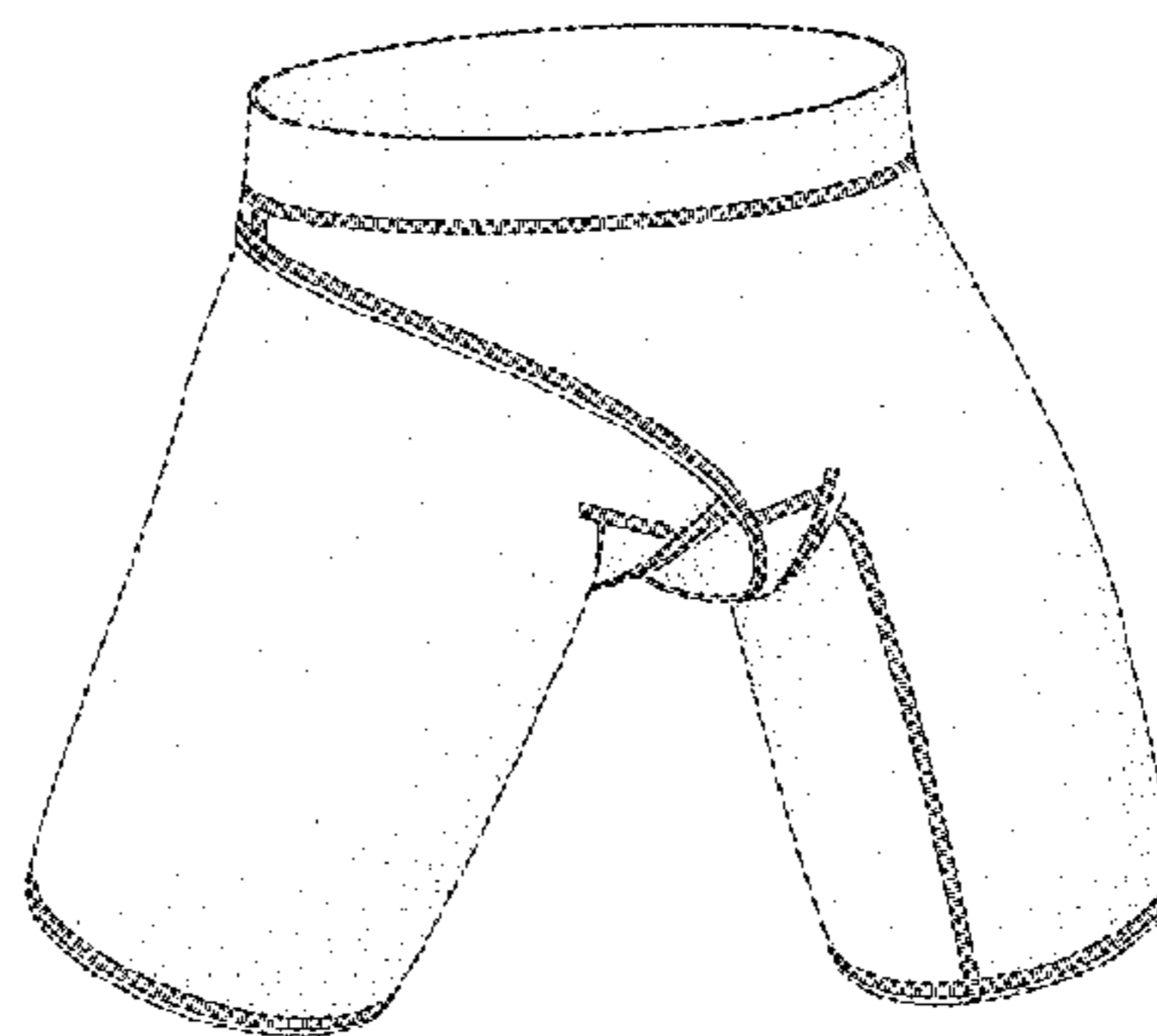
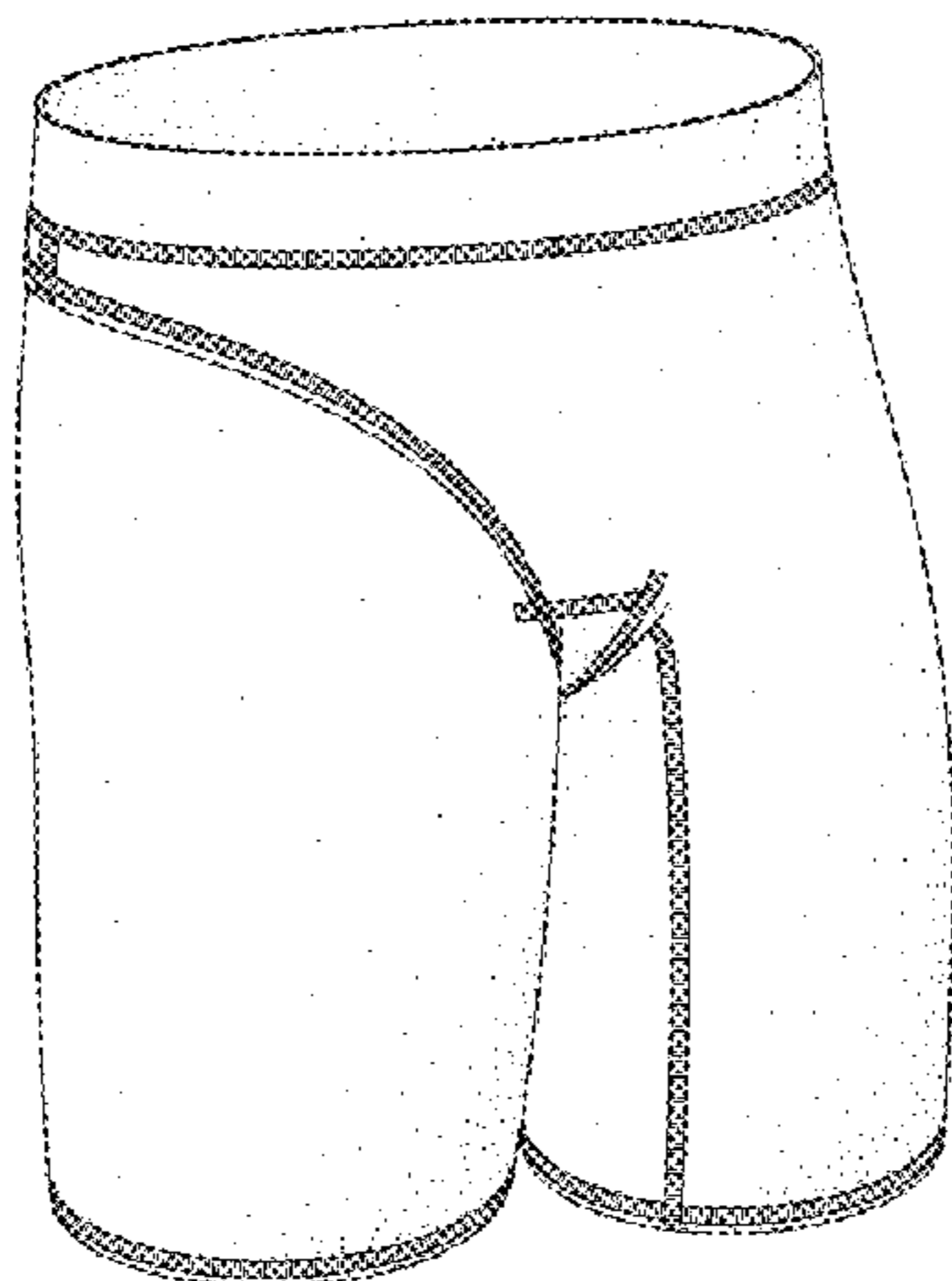

(56)

**References Cited**

U.S. PATENT DOCUMENTS

2014/0053322 A1\* 2/2014 Zamler ..... A41B 9/04  
2/407  
2014/0182048 A1\* 7/2014 Gregory ..... A41B 9/005  
2/400  
2015/0157058 A1\* 6/2015 McCombs ..... A41B 9/001  
2/400

OTHER PUBLICATIONS

<http://www.ergowear.com/gym-compression-shorts-red/>—Downloaded Feb. 10, 2016.\*

\* cited by examiner

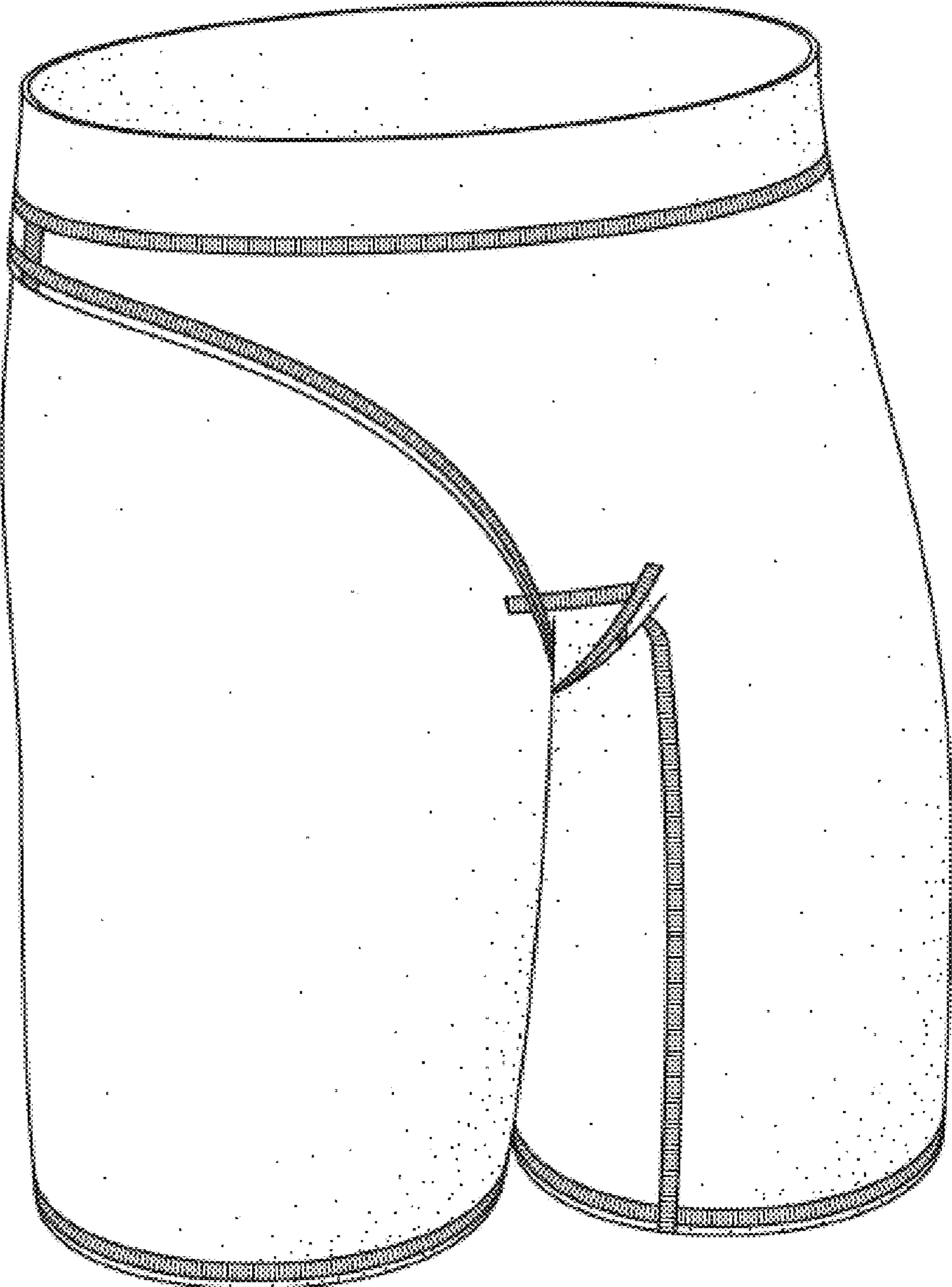

Fig. 1

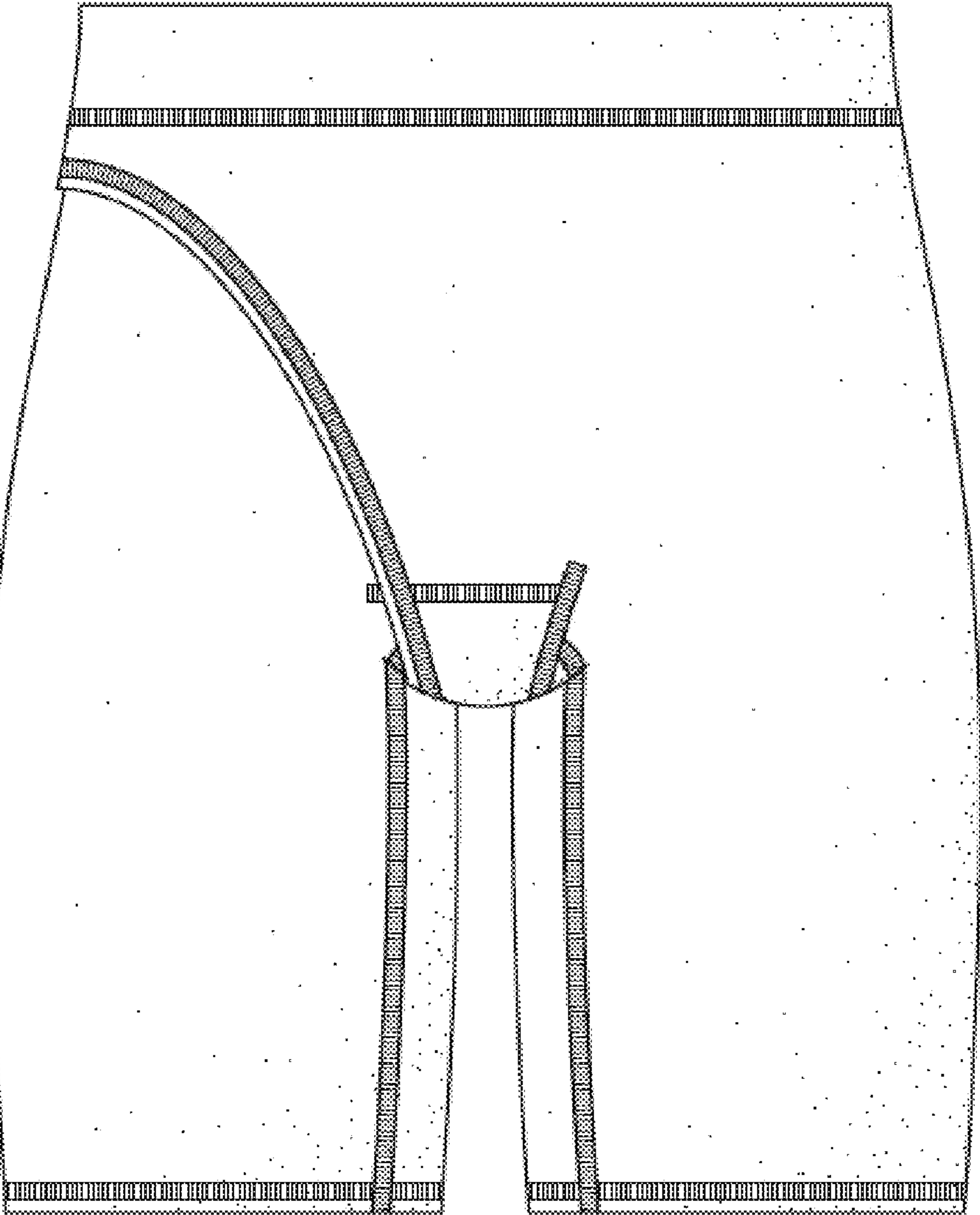

Fig. 2

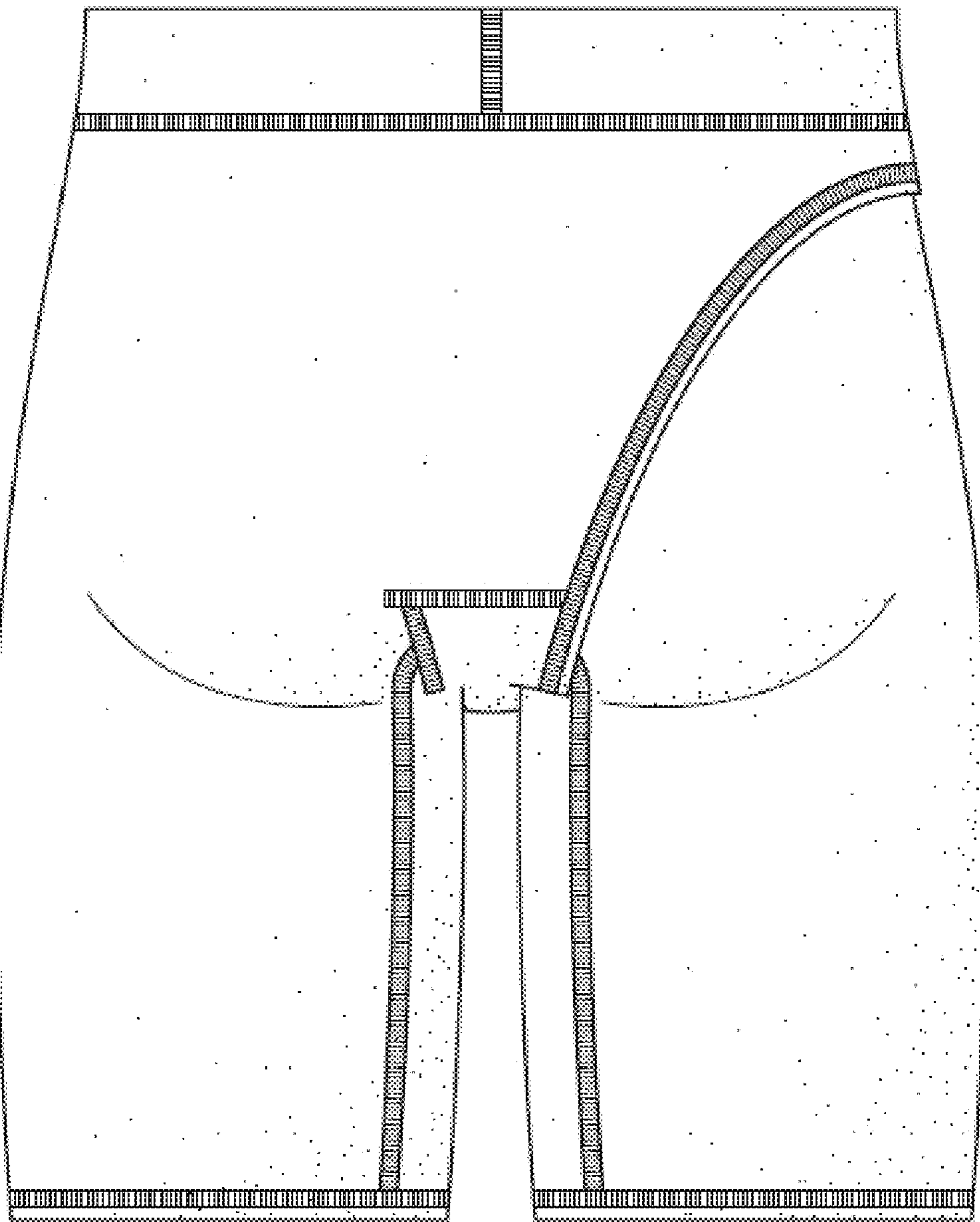

Fig. 3

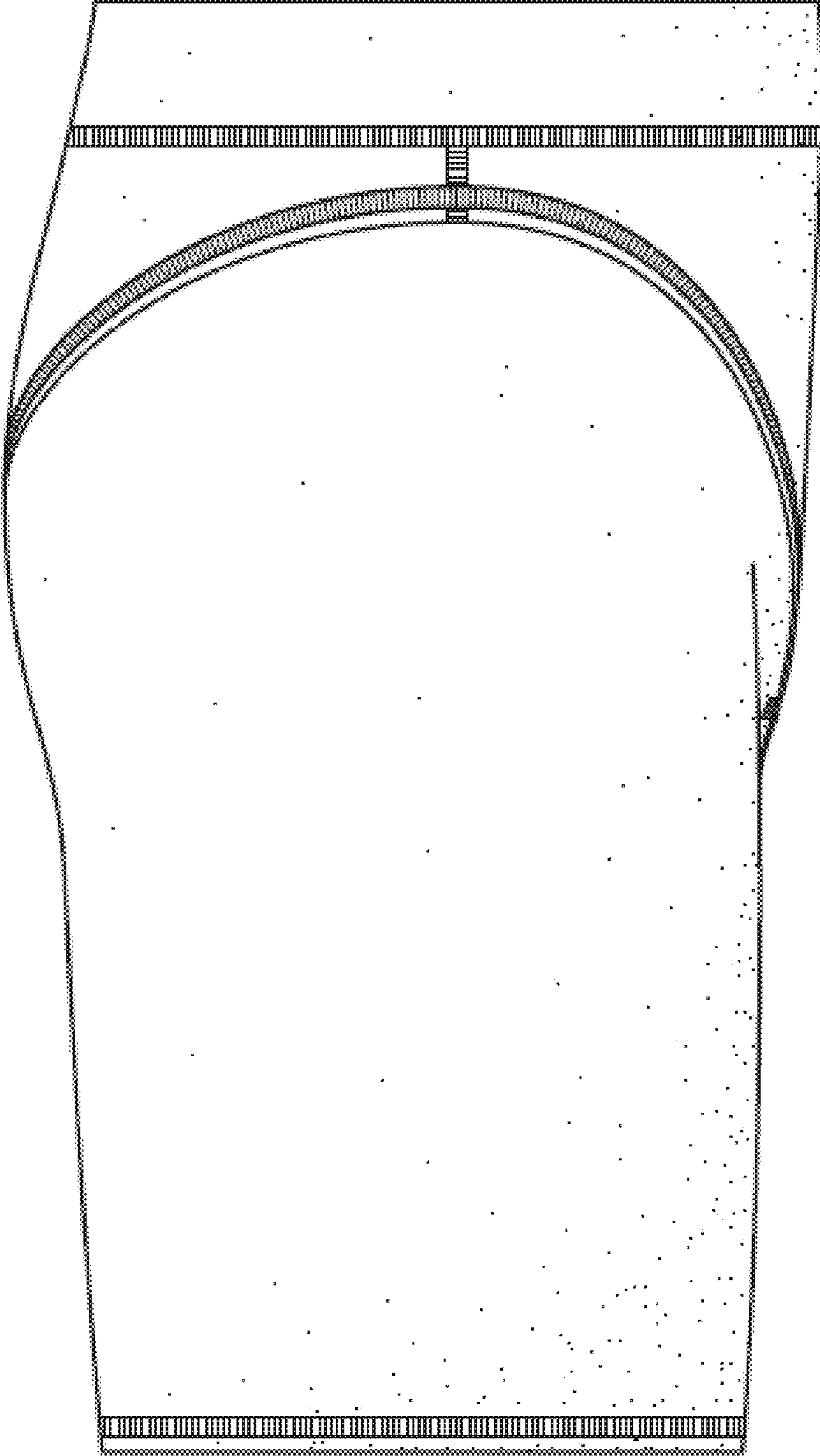

Fig. 4

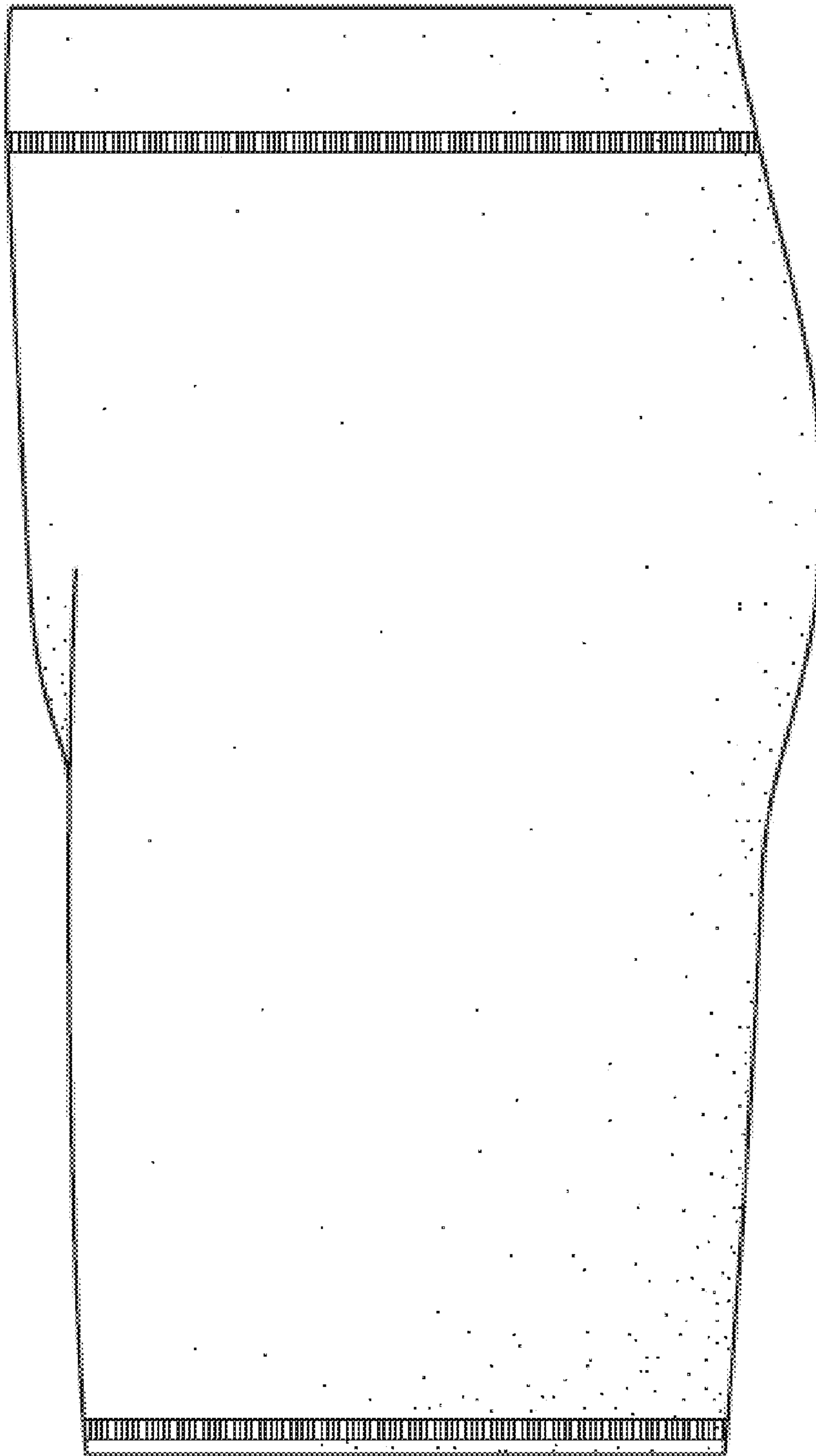

Fig. 5

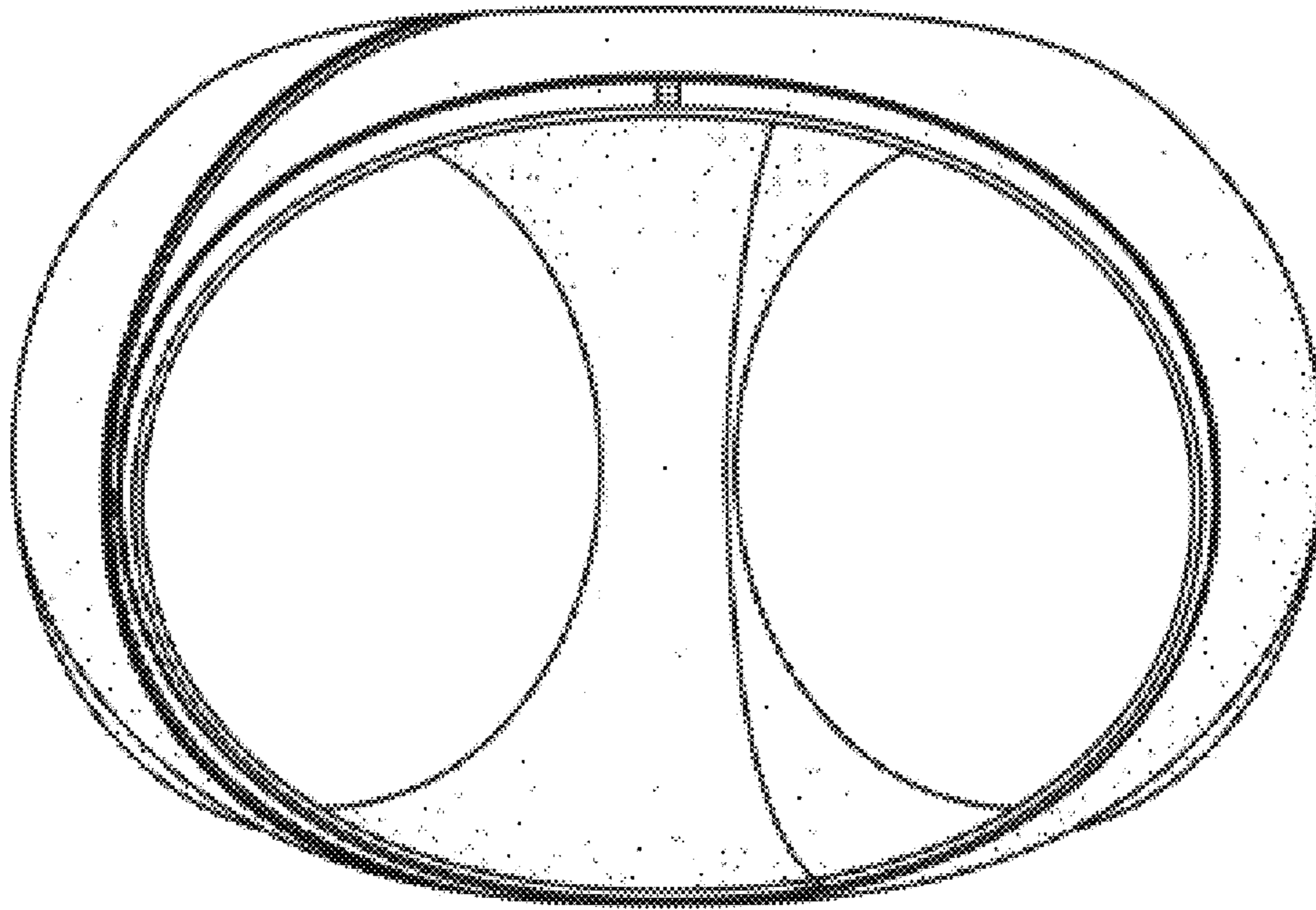

Fig. 6

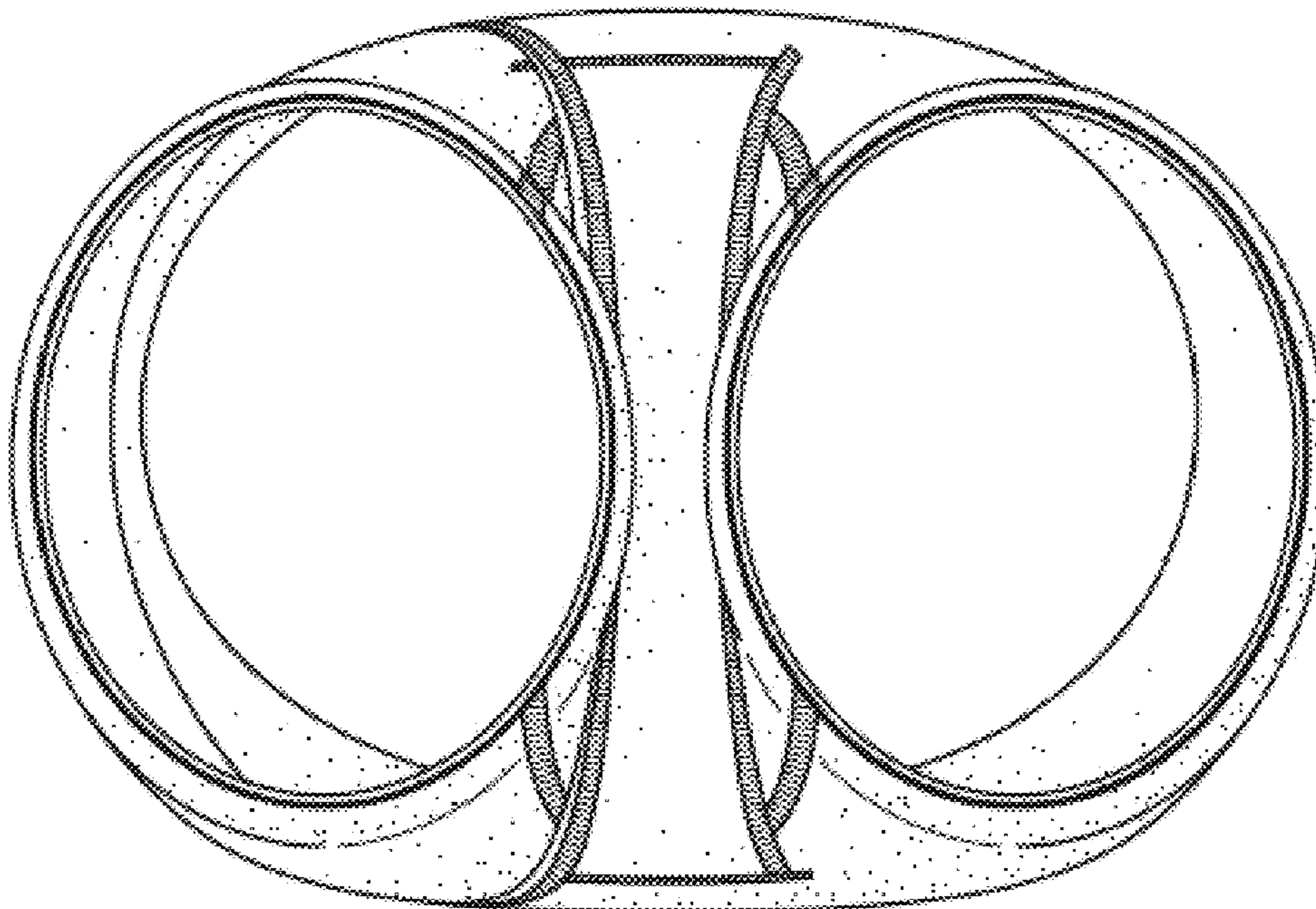

Fig. 7



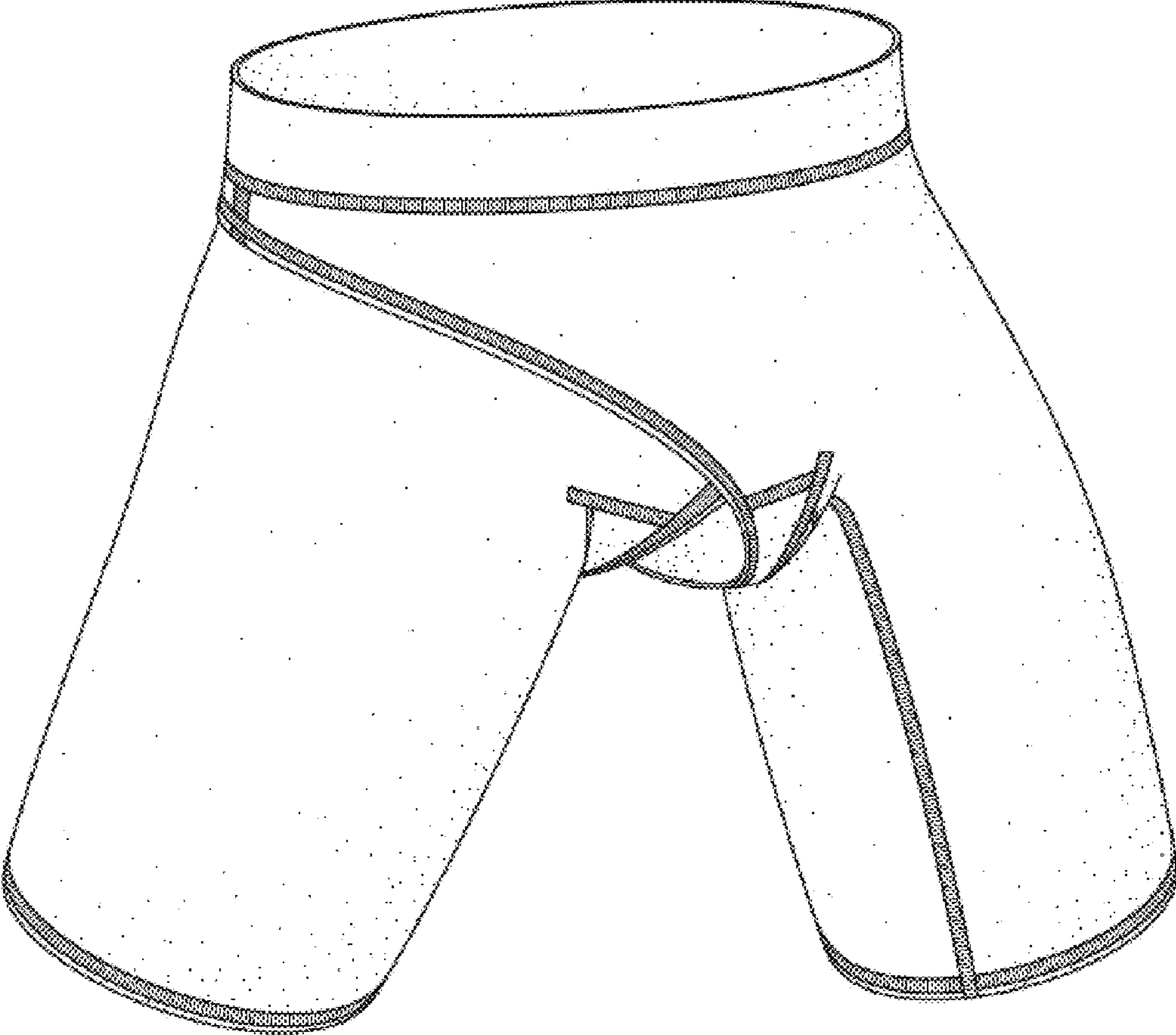

Fig. 8

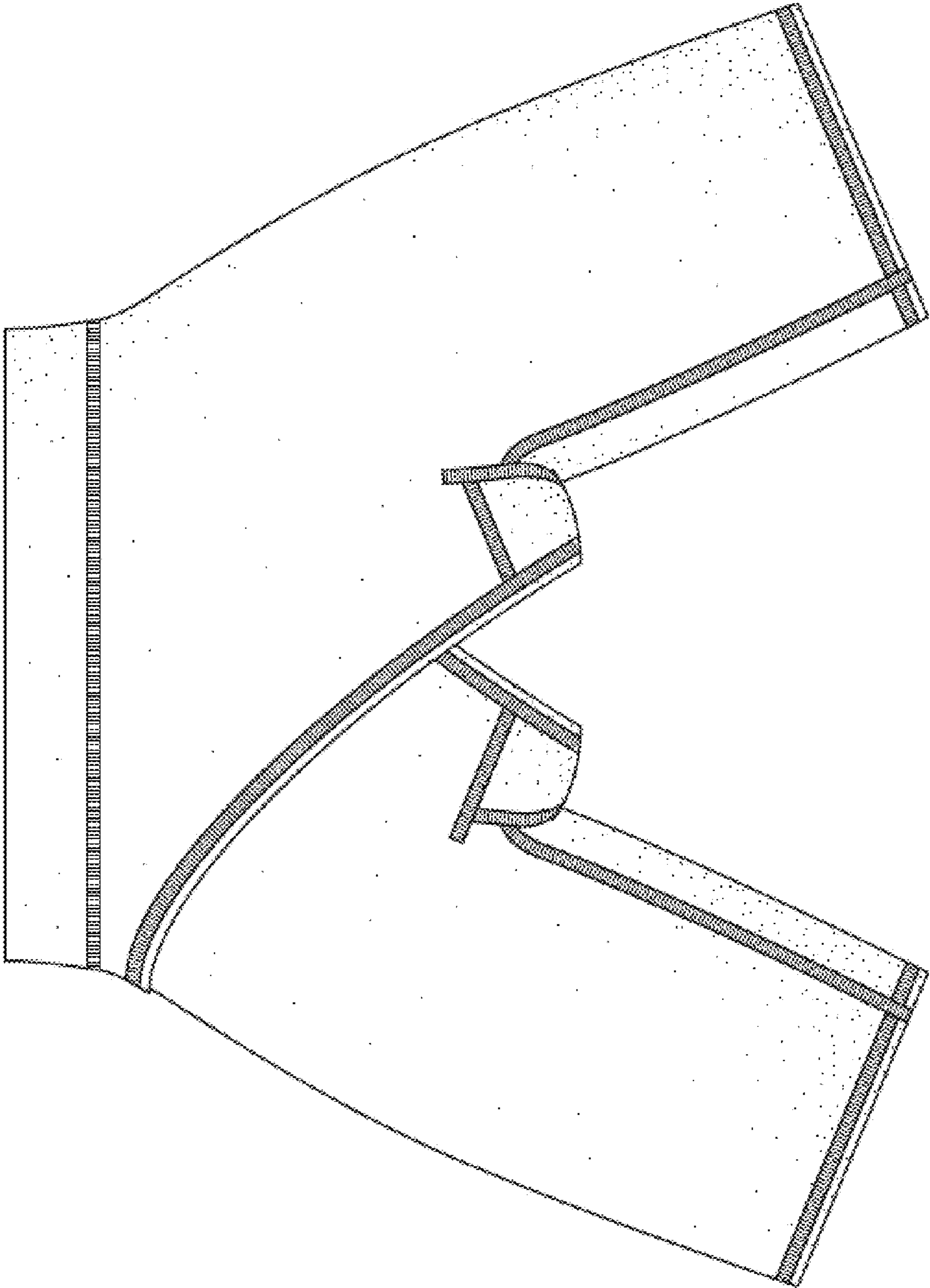

Fig. 9

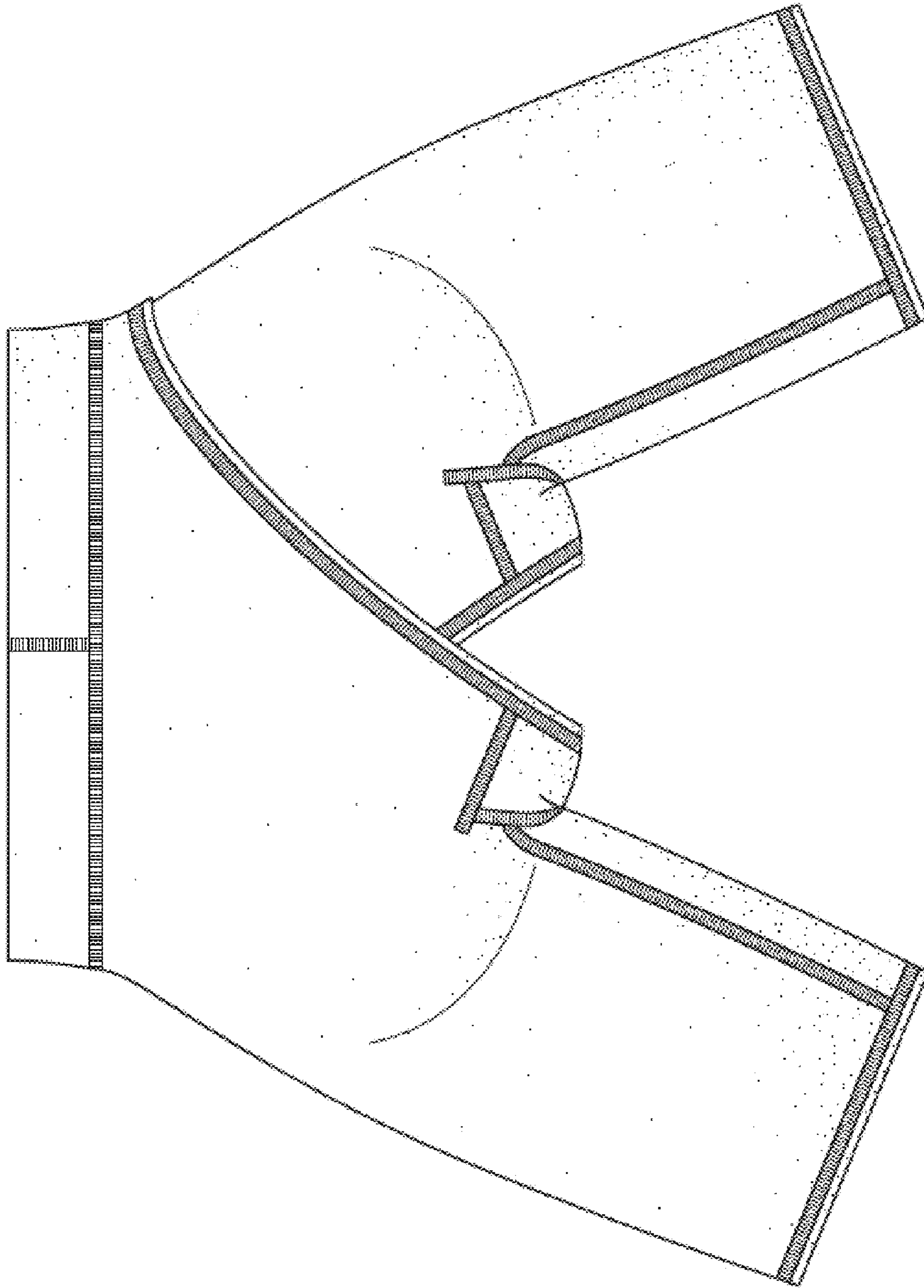

Fig. 10

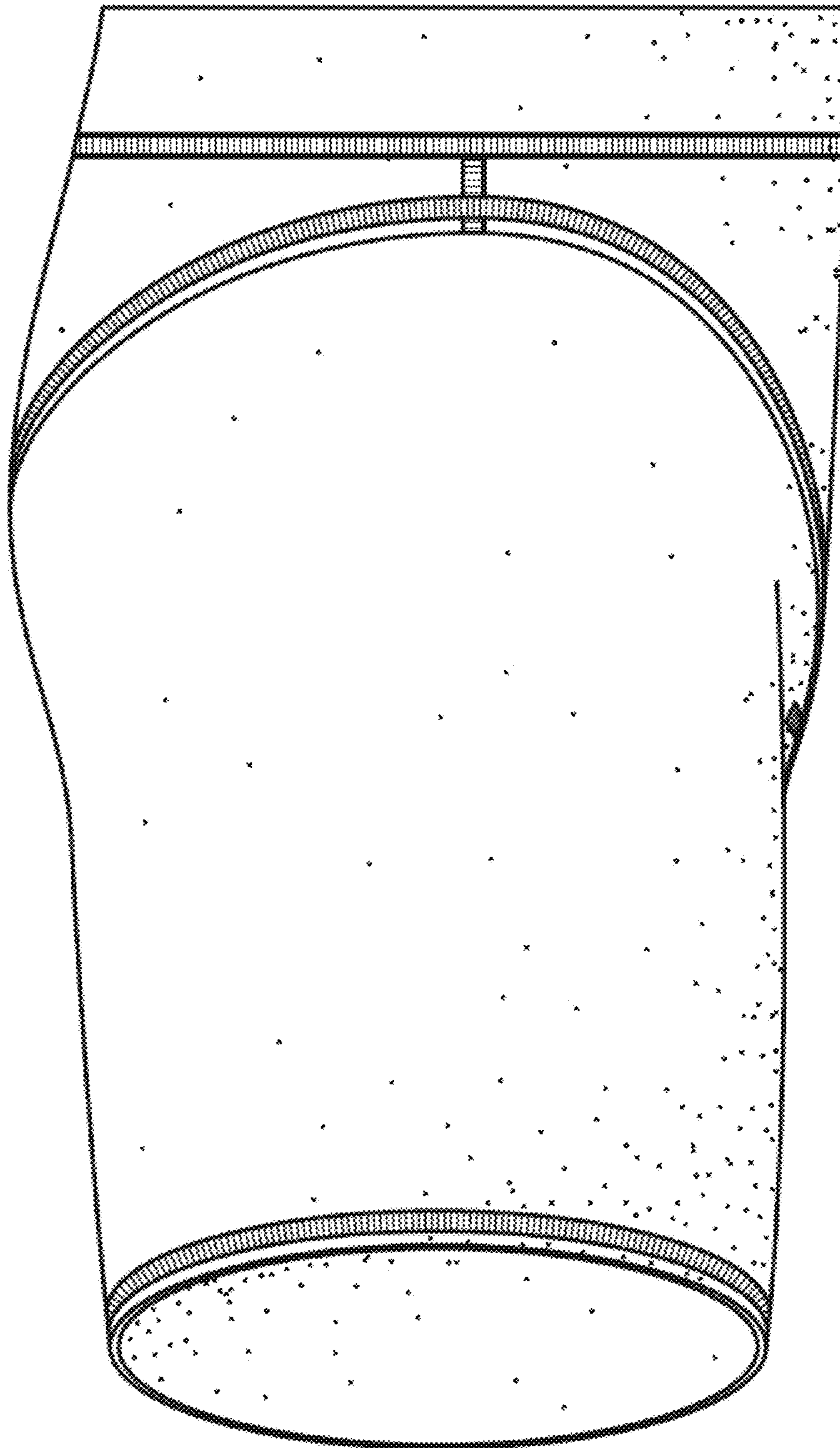

Fig. 11

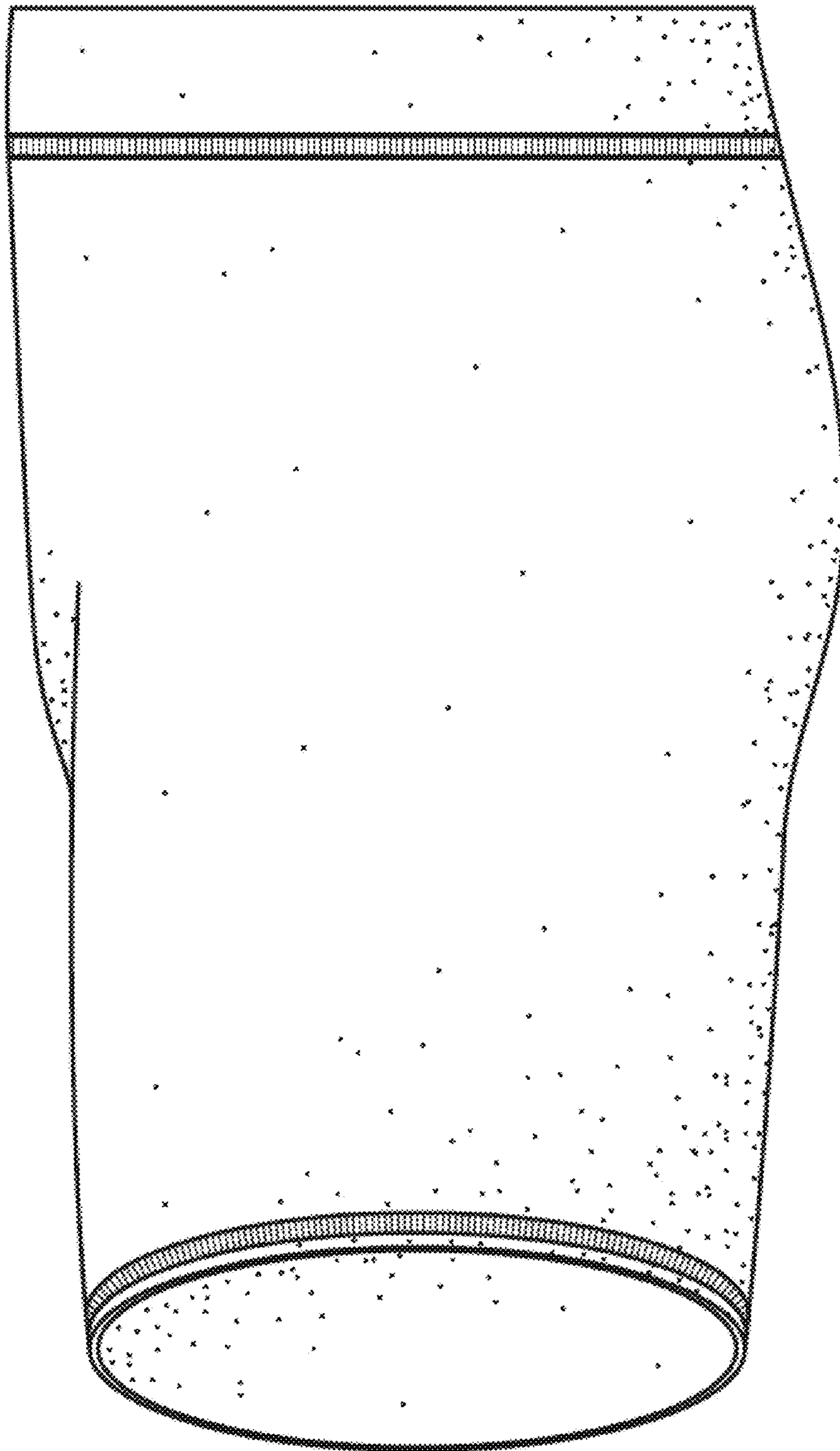

Fig. 12

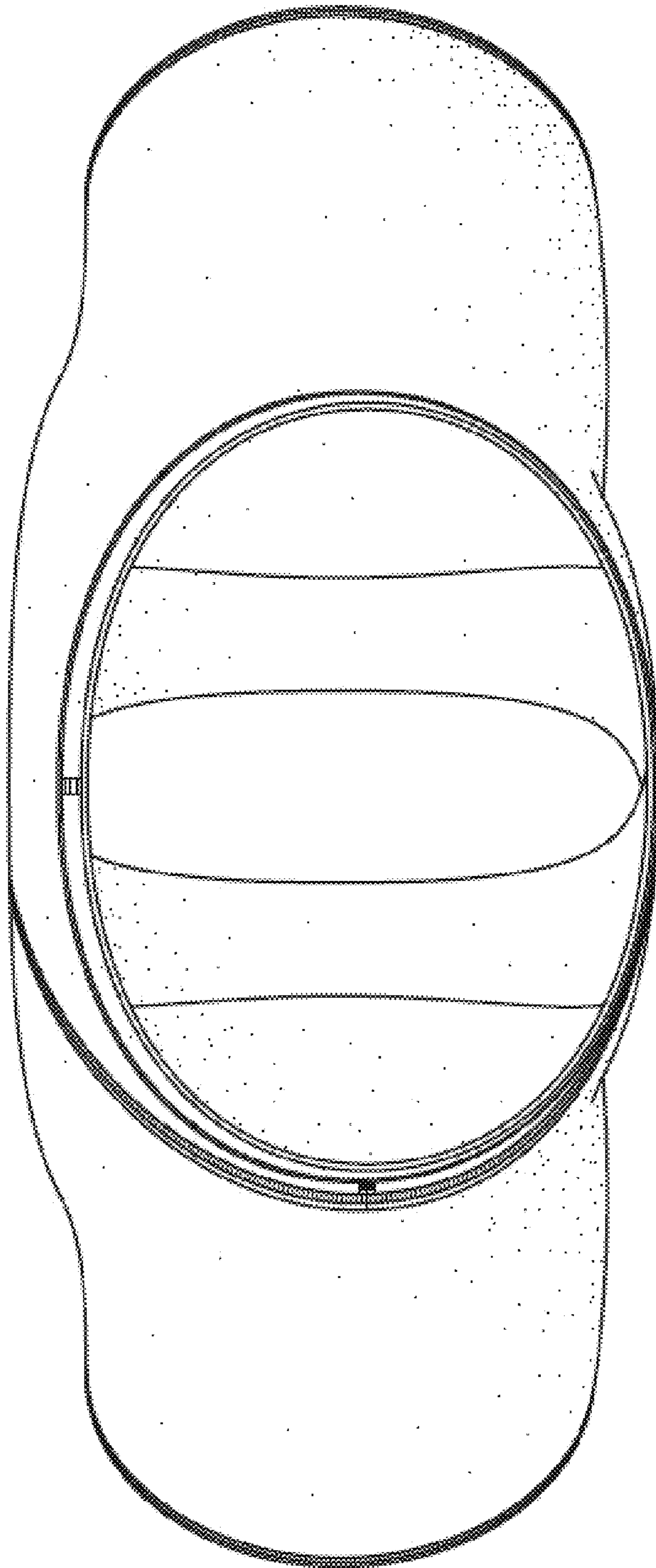

Fig. 13

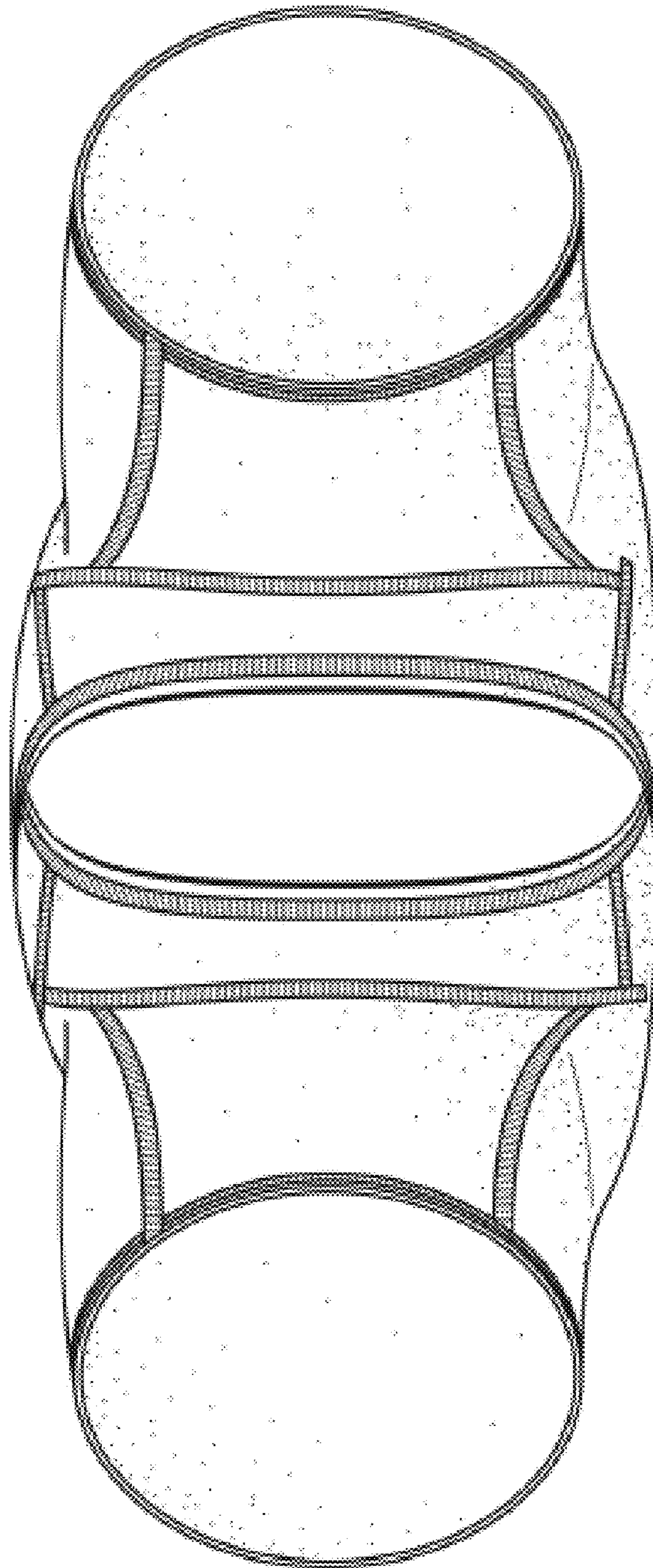

Fig. 14