



US00D774716S

(12) **United States Design Patent** (10) **Patent No.:** **US D774,716 S**  
**Kim** (45) **Date of Patent:** **\*\* Dec. 20, 2016**

(54) **WASHING MACHINE**

(71) Applicant: **Samsung Electronics Co., Ltd.**,  
Suwon-si, Gyeonggi-do (KR)

(72) Inventor: **Kangdoon Kim**, Seoul (KR)

(73) Assignee: **SAMSUNG ELECTRONICS CO., LTD.** (KR)

(\*\*) Term: **15 Years**

(21) Appl. No.: **29/539,914**

(22) Filed: **Sep. 18, 2015**

(30) **Foreign Application Priority Data**

Mar. 18, 2015 (KR) ..... 30-2015-0013694

(51) **LOC (10) Cl.** ..... **15-05**

(52) **U.S. Cl.**  
USPC ..... **D32/6**

(58) **Field of Classification Search**  
USPC ..... D32/1, 5, 6, 8, 12, 25, 28, 29  
CPC .... D06F 33/02; D06F 39/02; D06F 2204/065;  
D06F 25/00; D06F 35/006; D06F 58/00;  
D06F 58/02; D06F 58/04; D06F  
58/20; D06F 23/04; G05B 19/042  
See application file for complete search history.

(56) **References Cited**

**U.S. PATENT DOCUMENTS**

D465,622 S \* 11/2002 Wang ..... D32/6  
D515,257 S \* 2/2006 Geyer ..... D32/6  
D517,256 S \* 3/2006 Kim ..... D32/6  
D524,493 S \* 7/2006 Choi ..... D32/6  
D531,765 S \* 11/2006 Schoene ..... D32/8  
D536,143 S \* 1/2007 Takase ..... D32/5  
D566,347 S \* 4/2008 Cao ..... D32/1  
D575,913 S \* 8/2008 Jeon ..... D32/6  
D580,113 S 11/2008 Grutzke et al.  
D589,216 S \* 3/2009 Park ..... D32/6

D706,999 S \* 6/2014 Cho ..... D32/6  
D729,996 S \* 5/2015 Hwang ..... D32/6  
D730,596 S \* 5/2015 Kim ..... D32/6  
D731,131 S \* 6/2015 Ha ..... D32/25  
D731,719 S \* 6/2015 Borjesson ..... D32/6

(Continued)

**FOREIGN PATENT DOCUMENTS**

CN 301291064 S 7/2010

**OTHER PUBLICATIONS**

Carpete'S Blog: Whirlpool Eye in the Bathroom. [online].  
[retrieved on Sep. 18, 2015] pp. 1-3. Retrieved from the Internet:  
<URL: <http://peterpalsimon.blogspot.kr/2011/09/whirlpool-eye-in-bathroom.html>.

(Continued)

*Primary Examiner* — Michael A. Pratt  
*Assistant Examiner* — Michelle E Wilson  
(74) *Attorney, Agent, or Firm* — Cantor Colburn LLP

(57) **CLAIM**

The ornamental design for a washing machine, as shown and described.

**DESCRIPTION**

FIG. 1 is a perspective view of a washing machine, showing my new design;  
FIG. 2 is a front view thereof;  
FIG. 3 is a rear view thereof;  
FIG. 4 is a side view thereof;  
FIG. 5 is another side view thereof;  
FIG. 6 is a top view thereof;  
FIG. 7 is a bottom view thereof; and,  
FIG. 8 is another perspective view thereof.  
The broken lines illustrating portions of the washing machine form no part of the claimed design.

**1 Claim, 8 Drawing Sheets**

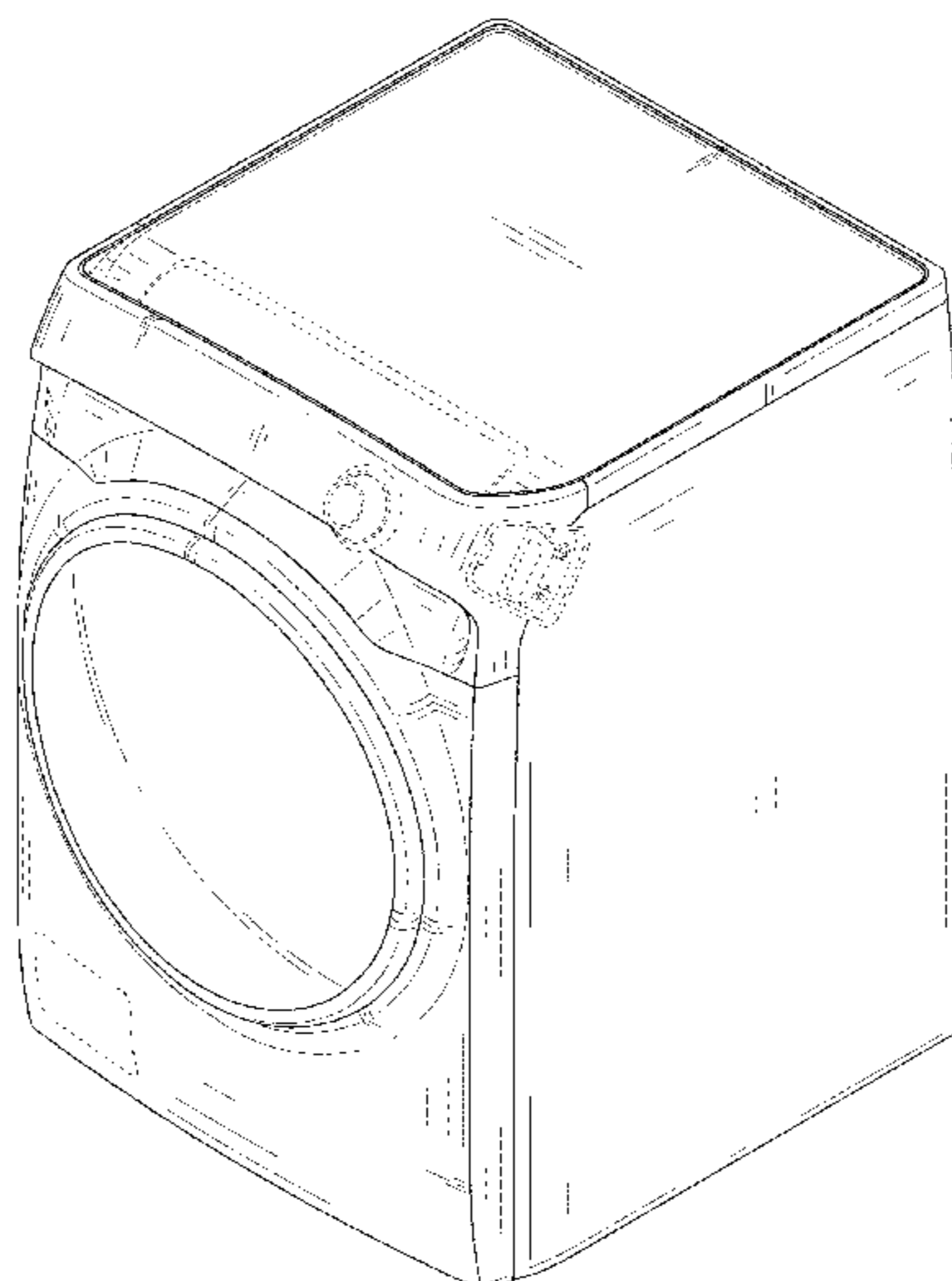

(56)

**References Cited**

U.S. PATENT DOCUMENTS

D732,250	S *	6/2015	Borjesson	.....	D32/6
D732,767	S *	6/2015	Ha	.....	D32/25
D753,353	S *	4/2016	Kim	.....	D32/6
D759,909	S *	6/2016	Kim	.....	D32/6
9,416,475	B2 *	8/2016	Kulkarni	.....	D06F 25/00
2016/0017530	A1 *	1/2016	Choi	.....	D06F 37/267 312/326
2016/0177491	A1 *	6/2016	Da Pont	.....	D06F 39/02 222/135
2016/0201248	A1 *	7/2016	Kim	.....	D06F 39/087 8/137
2016/0215435	A1 *	7/2016	Gasparini	.....	D06F 39/06
2016/0215436	A1 *	7/2016	Gasparini	.....	D06F 39/06
2016/0222574	A1 *	8/2016	Bae	.....	D06F 33/02
2016/0230328	A1 *	8/2016	Bae	.....	D06F 33/02

OTHER PUBLICATIONS

TLC-MissYuan.net. [online]. [retrieved on Sep. 18, 2015] pp. 1-3.  
 Retrieved from the Internet: <URL: [http://www.missyuan.net/article/20070707/lw\\_15384\\_2.html](http://www.missyuan.net/article/20070707/lw_15384_2.html).

Tumbl 360 Washing Machine. [online]. [retrieved on Sep. 18, 2015]  
 pp. 1-6. Retrieved from the Internet: <URL: <http://ajinkyabarve.com/tumbl-360--washing-machine.html>.

\* cited by examiner

FIG. 1

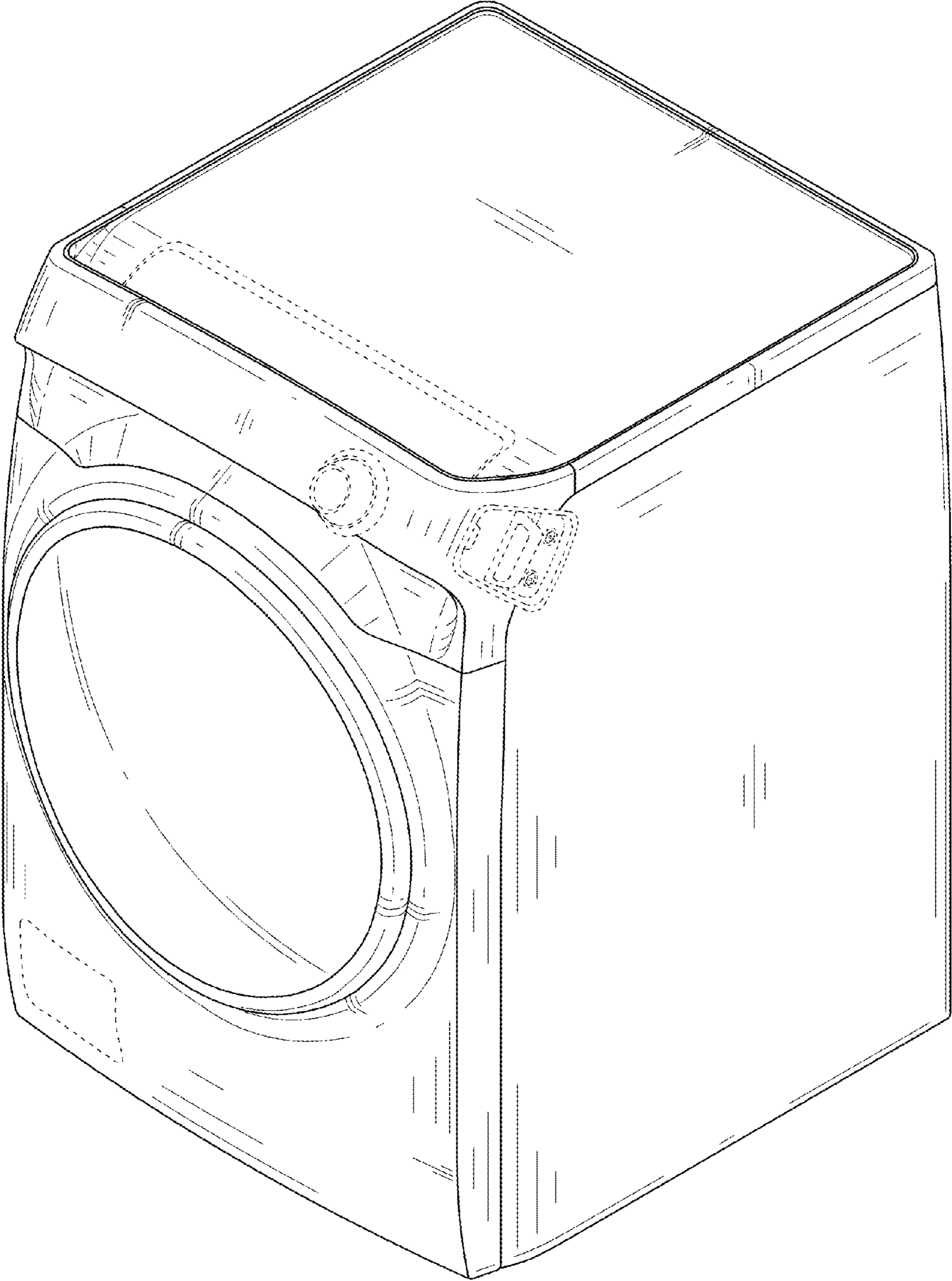

FIG. 2

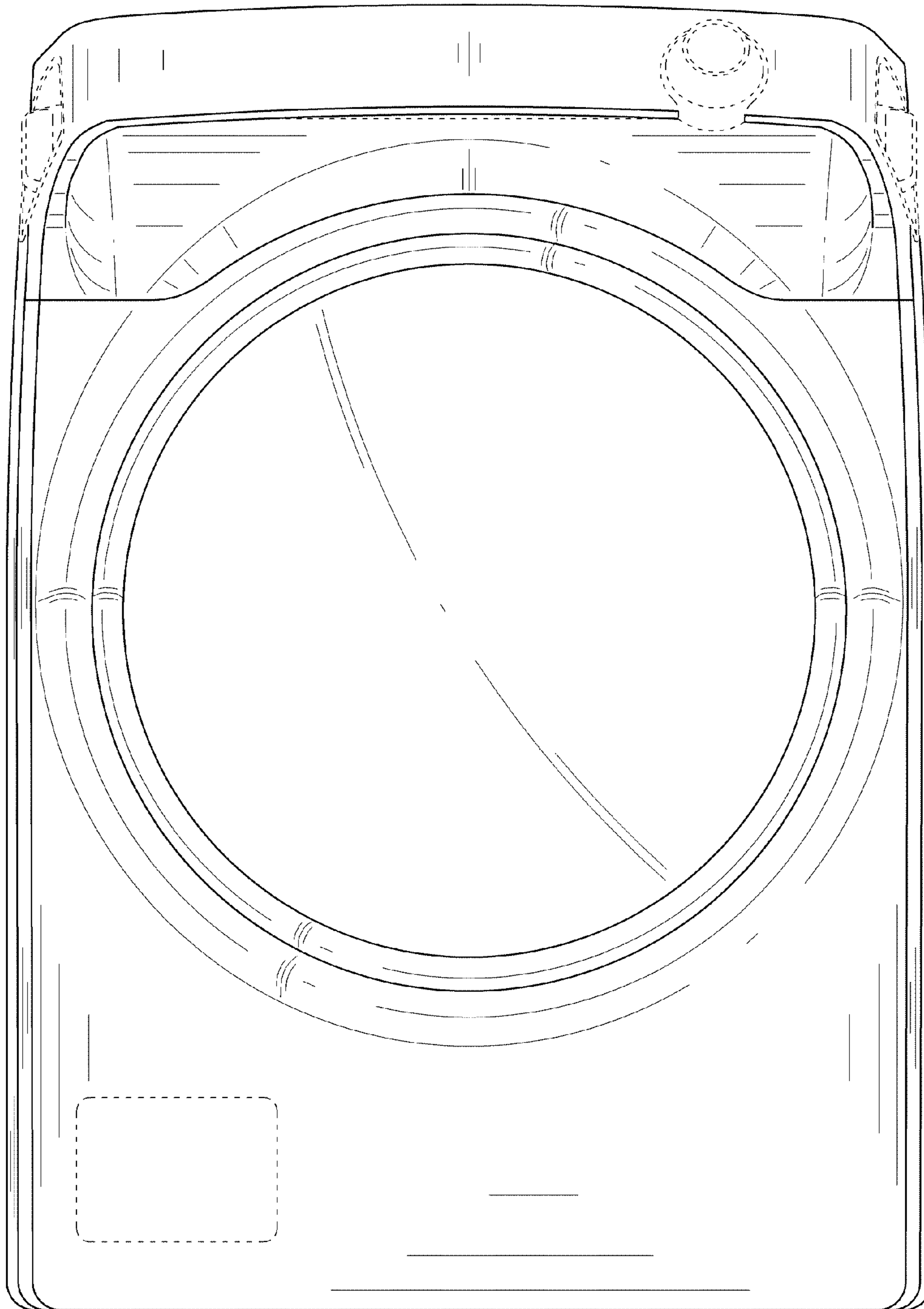

FIG. 3

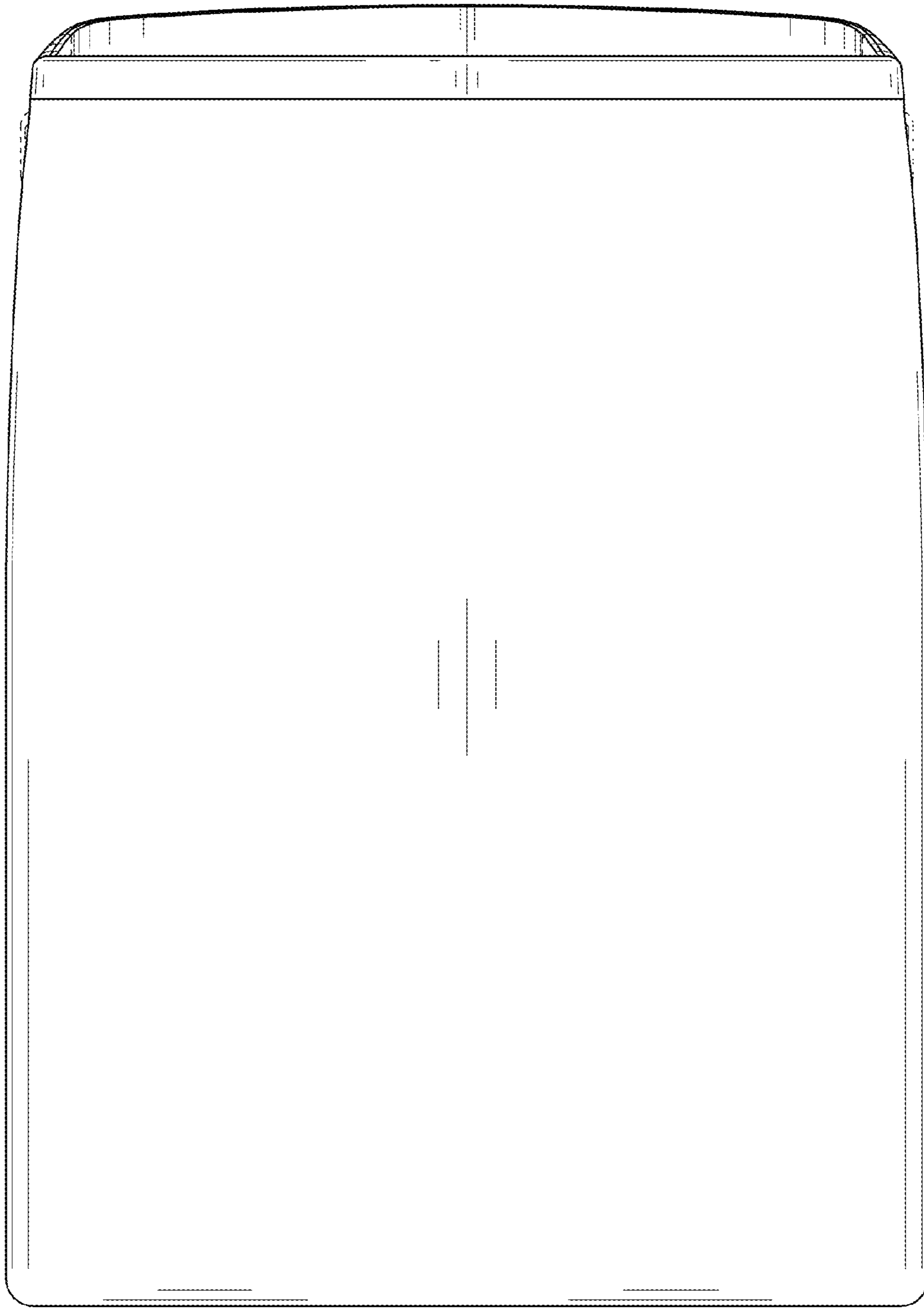

FIG. 4

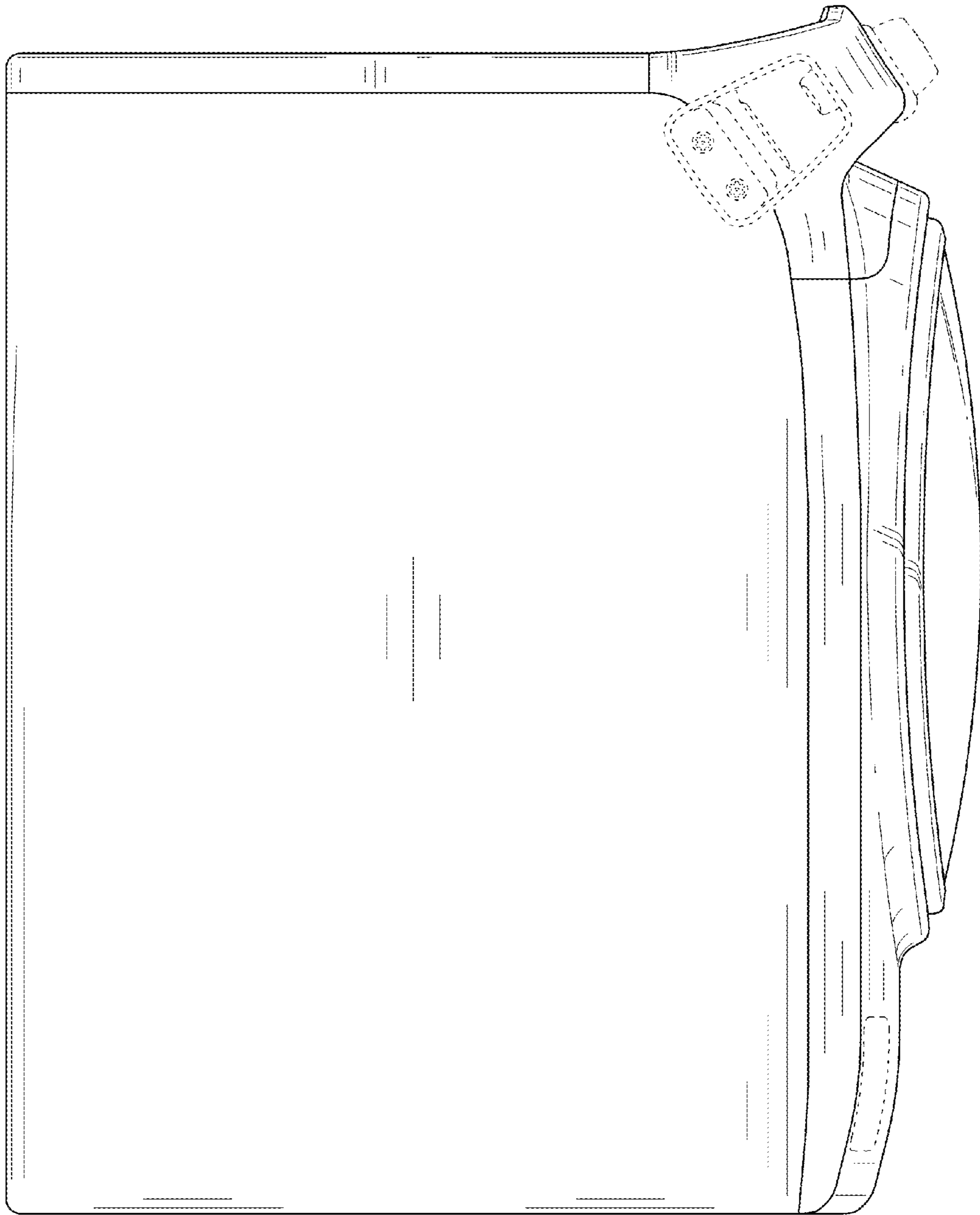

FIG. 5

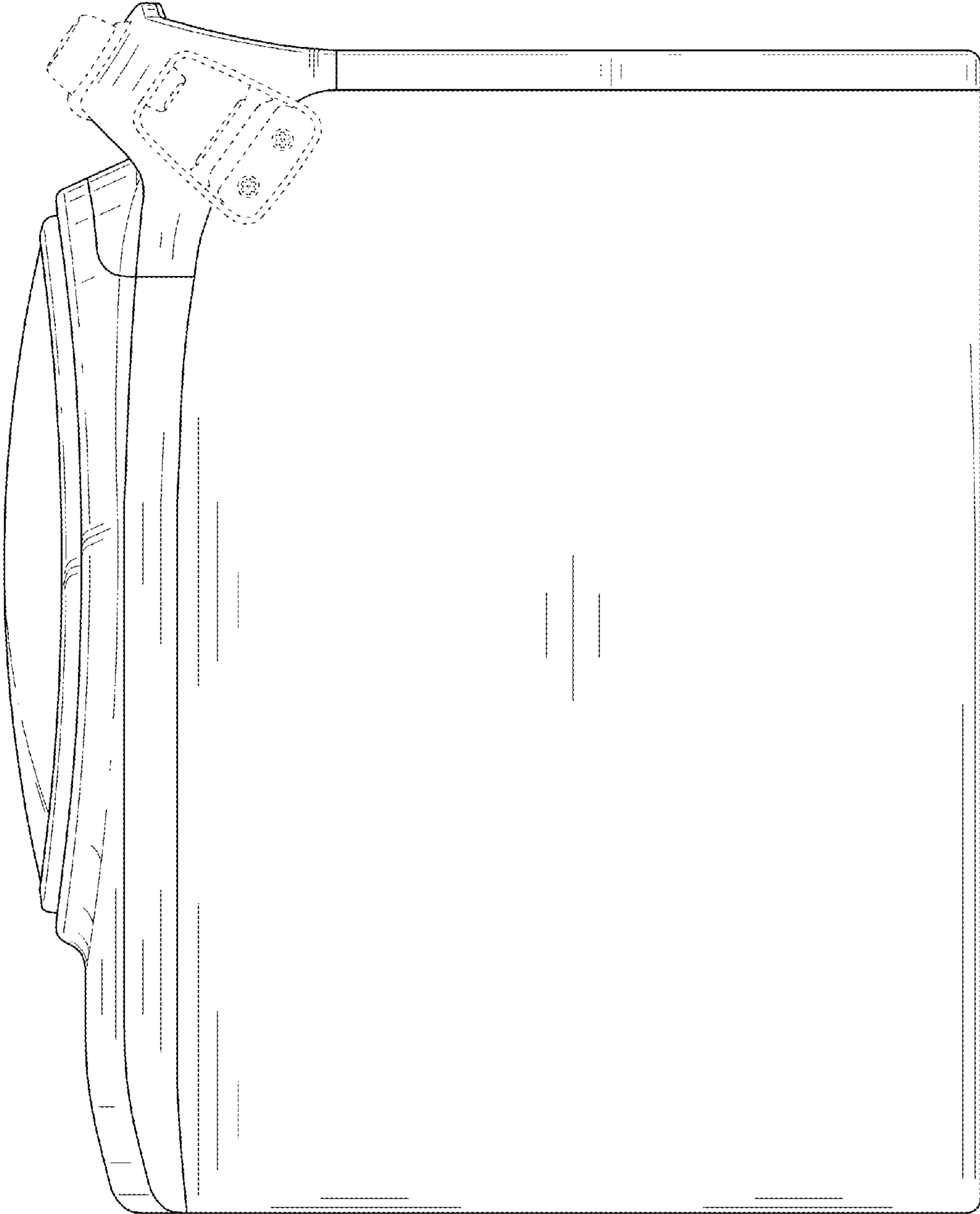

FIG. 6

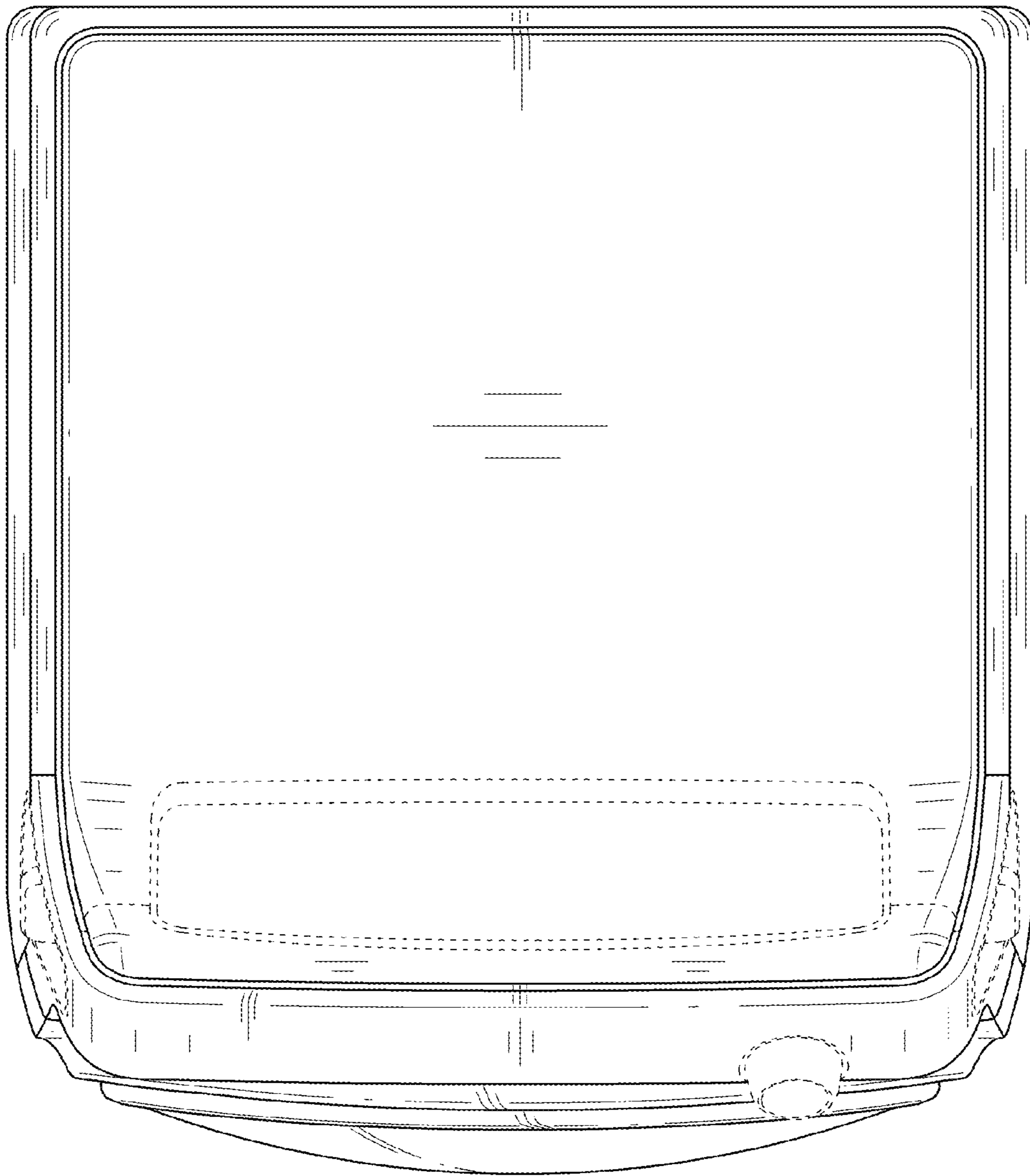



FIG. 7

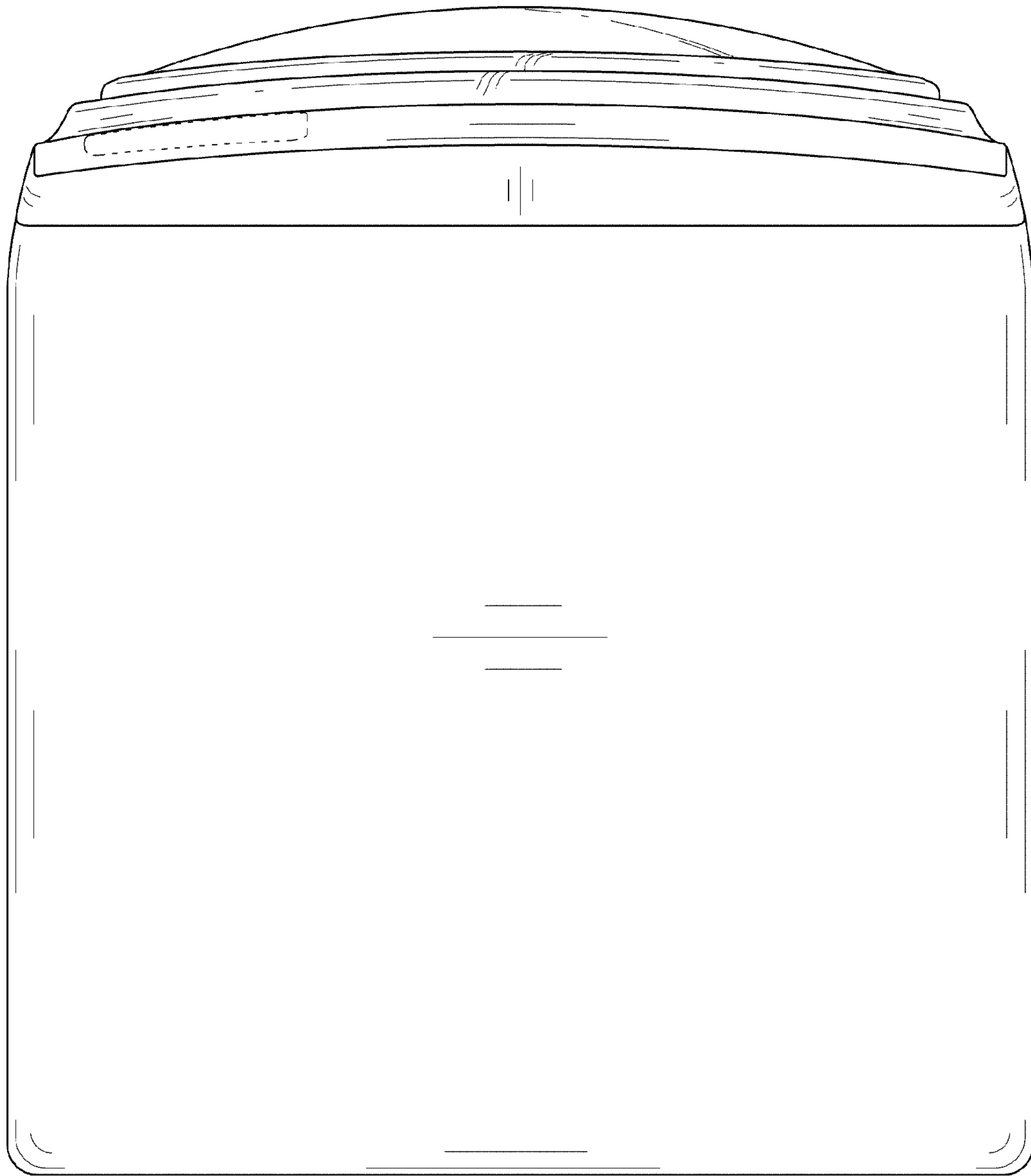

FIG. 8

