



US00D774620S

(12) **United States Design Patent**  
**Shelton et al.**

(10) **Patent No.:** **US D774,620 S**

(45) **Date of Patent:** **\*\* Dec. 20, 2016**

- (54) **PANEL ATTACHABLE TO A RAIL OF A FIREARM**
- (71) Applicant: **RailScales LLC**, Broken Arrow, OK (US)
- (72) Inventors: **Derek Hunter Shelton**, Claremore, OK (US); **Brent Taylor McGuire**, Depew, OK (US)
- (73) Assignee: **RAILSCALES LLC**, Broken Arrow, OK (US)
- (\*\*) Term: **15 Years**
- (21) Appl. No.: **29/549,064**
- (22) Filed: **Dec. 18, 2015**
- (51) **LOC (10) Cl.** ..... **22-01**
- (52) **U.S. Cl.**  
USPC ..... **D22/108**
- (58) **Field of Classification Search**  
USPC ..... D22/108, 103; 42/1.01–1.07, 2, 90, 42/10–26, 36, 37; 89/40.06, 41.19, 37.04, 89/33.04, 191.01, 200–204; D21/572–575; 124/66, 67, 72, 743  
CPC ..... F41C 23/16; F41A 35/02; F41G 11/003  
See application file for complete search history.

(56) **References Cited**

**U.S. PATENT DOCUMENTS**

- 6,029,321 A \* 2/2000 Fisher ..... F41C 33/001 124/35.2
- D533,618 S \* 12/2006 Swan ..... D22/110
- D537,499 S \* 2/2007 Swan ..... D22/110
- D548,811 S \* 8/2007 Swan ..... D22/109

(Continued)

**OTHER PUBLICATIONS**

Pick Your Texture, RailScales website, [online]. [site visited Sep. 28, 2016]. <URL: <http://www.getrailscales.com/category-s/1838.htm>>.\*

(Continued)

*Primary Examiner* — T. Chase Nelson  
*Assistant Examiner* — Jonathan J Han  
(74) *Attorney, Agent, or Firm* — Sutherland Asbill & Brennan LLP

(57) **CLAIM**

The ornamental design for a panel attachable to a rail of a firearm, as shown and described.

**DESCRIPTION**

FIG. 1 is a perspective view of a panel attachable to a rail of a firearm according to a first embodiment of the disclosure;

FIG. 2 is a perspective view thereof;

FIG. 3 is a perspective view thereof;

FIG. 4 is a perspective view thereof;

FIG. 5 is a perspective view thereof;

FIG. 6 is a perspective view thereof;

FIG. 7 is a front view thereof;

FIG. 8 is a rear view thereof;

FIG. 9 is a side view thereof;

FIG. 10 is a side view thereof;

FIG. 11 is a bottom view thereof;

FIG. 12 is a top view thereof;

FIG. 13 is a perspective view of a panel attachable to a rail of a firearm according to a second embodiment of the disclosure;

FIG. 14 is a perspective view thereof;

FIG. 15 is a perspective view thereof;

FIG. 16 is a perspective view thereof;

FIG. 17 is a perspective view thereof;

FIG. 18 is a perspective view thereof;

FIG. 19 is a front view thereof;

FIG. 20 is a rear view thereof;

FIG. 21 is a side view thereof;

FIG. 22 is a side view thereof;

FIG. 23 is a bottom view thereof; and,

FIG. 24 is a top view thereof.

**1 Claim, 24 Drawing Sheets**

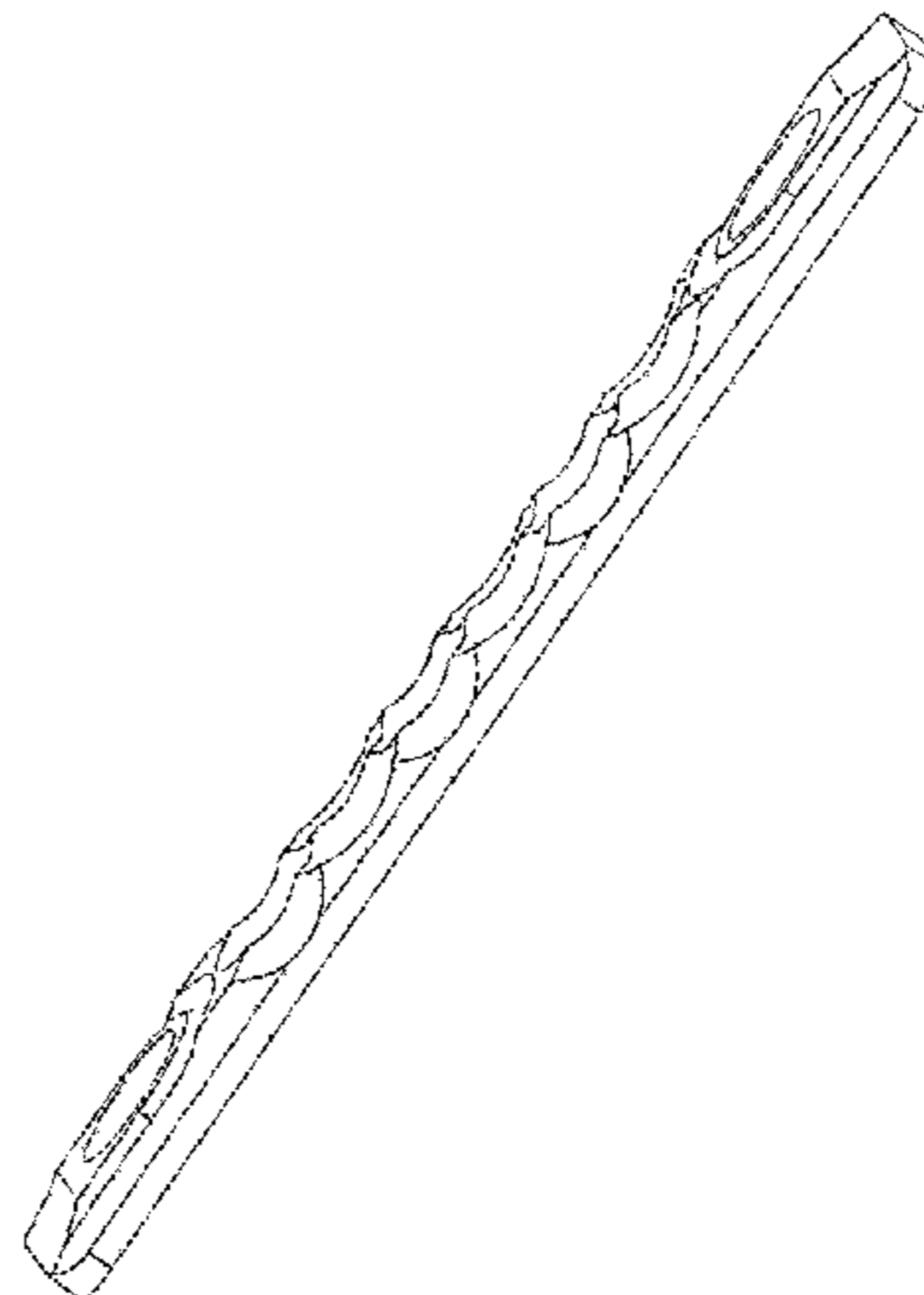
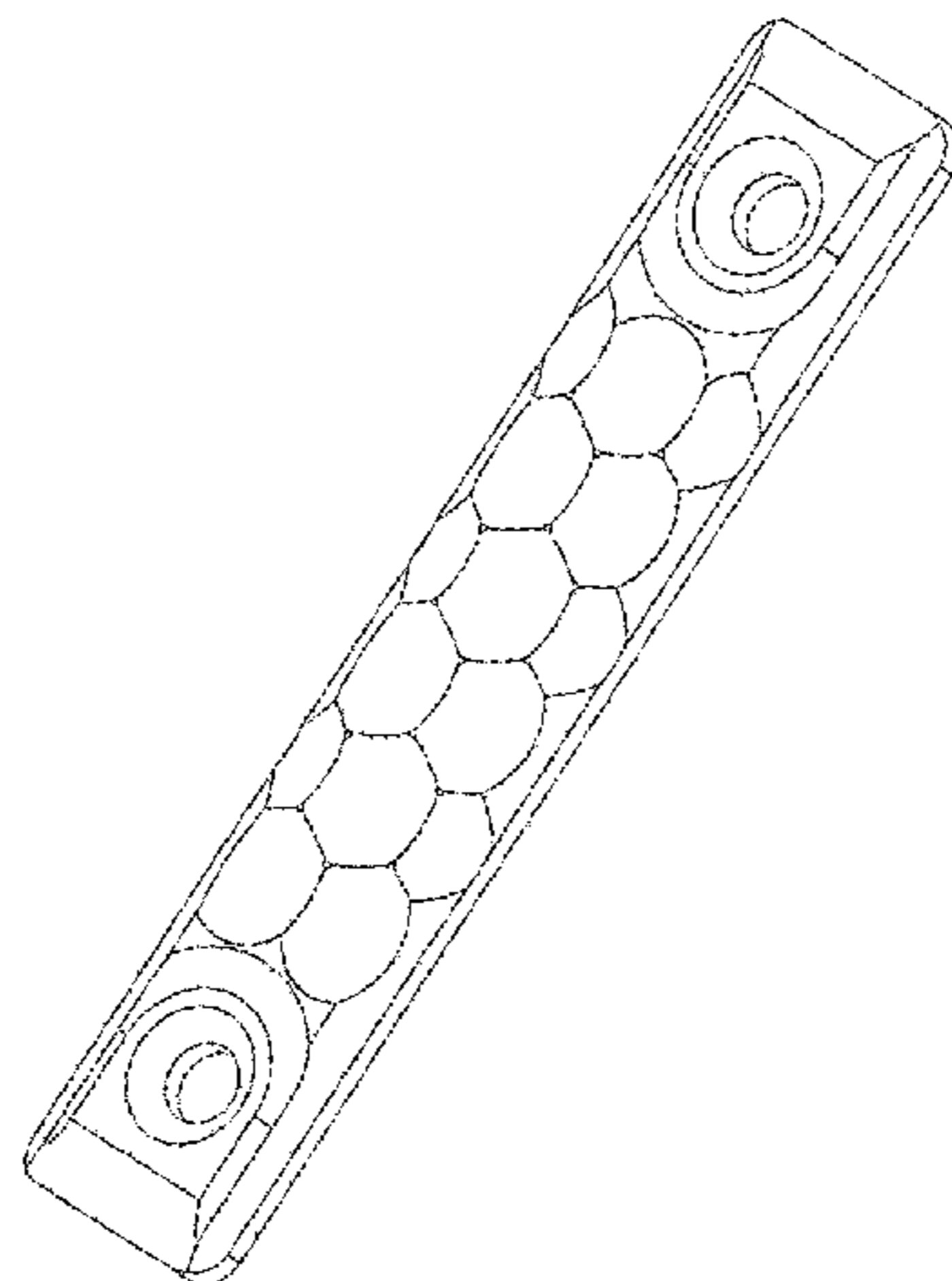

(56)

References Cited

U.S. PATENT DOCUMENTS

D561,864 S \* 2/2008 Rigler ..... D22/110  
 D625,378 S \* 10/2010 Fitzpatrick ..... D22/108  
 7,861,451 B1 \* 1/2011 Moody ..... F41A 23/08  
 42/71.01  
 D639,889 S \* 6/2011 Troy, Jr. .... D22/108  
 8,104,218 B2 \* 1/2012 McCann ..... F41G 1/033  
 42/111  
 D683,417 S \* 5/2013 Daniel ..... D22/108  
 D691,235 S \* 10/2013 Fitzpatrick ..... D22/108  
 D704,789 S \* 5/2014 Fitzpatrick ..... D22/108  
 D704,791 S \* 5/2014 Fitzpatrick ..... D22/108  
 D705,885 S \* 5/2014 Peterson ..... D22/108  
 D707,782 S \* 6/2014 Burnham ..... D22/108  
 8,826,797 B2 \* 9/2014 Overstreet ..... F41A 3/12  
 89/128  
 D719,632 S \* 12/2014 Lau ..... D22/108  
 8,935,874 B2 \* 1/2015 Troy ..... F41A 35/02  
 42/90  
 8,959,825 B2 \* 2/2015 Goertzen ..... F41G 11/001  
 42/124  
 D725,223 S \* 3/2015 Heidkamp ..... D22/109  
 8,984,797 B2 \* 3/2015 Ballard ..... F41G 1/00  
 42/111  
 D726,864 S \* 4/2015 Huang, Sr. .... D22/108  
 9,015,982 B1 \* 4/2015 Powers ..... F41G 1/44  
 42/119  
 D734,827 S \* 7/2015 Pearson ..... D22/108  
 D737,923 S \* 9/2015 Norberg ..... D22/108  
 D737,925 S \* 9/2015 Norberg ..... D22/109  
 9,222,749 B1 \* 12/2015 Nakayama ..... F41C 23/16  
 D756,763 S \* 5/2016 Swan ..... D22/109  
 9,360,273 B1 \* 6/2016 Steinbock ..... F41C 27/00  
 D761,928 S \* 7/2016 Adair ..... D22/108  
 2003/0106252 A1 \* 6/2003 Hines ..... F41A 35/02  
 42/90  
 2009/0241397 A1 \* 10/2009 Fitzpatrick ..... F41C 23/16  
 42/90  
 2009/0293334 A1 \* 12/2009 Swan ..... F41C 33/007  
 42/90  
 2010/0186278 A1 \* 7/2010 Daniel ..... F41C 23/16  
 42/71.01  
 2010/0236124 A1 \* 9/2010 Troy ..... F41A 35/02  
 42/90  
 2011/0099873 A1 \* 5/2011 Bentley ..... F41C 23/16  
 42/71.01  
 2012/0030986 A1 \* 2/2012 Swan ..... F41C 23/02  
 42/85  
 2012/0085013 A1 \* 4/2012 Cahill ..... F41A 35/02  
 42/96

2013/0000176 A1 \* 1/2013 Goertzen ..... F41G 11/003  
 42/90  
 2013/0031820 A1 \* 2/2013 Deros ..... F41G 11/003  
 42/90  
 2013/0055614 A1 \* 3/2013 Finnegan ..... F41G 11/003  
 42/90  
 2013/0061504 A1 \* 3/2013 Malherbe ..... F41G 11/003  
 42/84  
 2013/0326925 A1 \* 12/2013 Power ..... F41C 23/16  
 42/71.01  
 2015/0040456 A1 \* 2/2015 Zimmer ..... F41G 11/003  
 42/90

OTHER PUBLICATIONS

Dragon Keymod, RailScales website, [online]. [site visited Sep. 28, 2016]. <URL: <http://www.getrailscales.com/SearchResults.asp?Cat=1835>>.\*  
 Honeycomb Keymod, RailScales website, [online]. [site visited Sep. 28, 2016]. <URL: <http://www.getrailscales.com/SearchResults.asp?Cat=1862>>.\*  
 Tenderizer Keymod, RailScales website, [online]. [site visited Sep. 28, 2016]. <URL: <http://www.getrailscales.com/SearchResults.asp?Cat=1852>>.\*  
 ERGO Ergolok Low Pro Locking Rail Covers—Black, Del-Ton.com, [online], [site visited Sep. 28, 2016]. <URL: [http://www.del-ton.com/Rail\\_Panels\\_p/hg1087.htm](http://www.del-ton.com/Rail_Panels_p/hg1087.htm)>.\*  
 Knights URX3 for example. Grip panels and handstop installed. forums.spacebattels.com, Posted by Sushi, Jun. 20, 2014, [online], [site visited Sep. 28, 2016]. <URL: <https://forums.spacebattles.com/threads/so-mjolnir-what-have-you-been-doing-this-week-303160>>.\*  
 Griffin Armament Low-Pro RIGID rail kits available, ar15news.com, Posted Jul. 16, 2016, [online], [site visited Sep. 28, 2016]. <URL: <http://www.ar15news.com/category/accessories/rail-covers/>>.\*  
 XT Rail Cover Black, Bravo Company USA, Inc., [online], [site visited Sep. 28, 2016]. <URL: <http://www.bravocompanyusa.com/Magpul-XT-Rail-Covers-Black-p/mag012%20black.htm>>.\*  
 Troy Industries Battle Rail Cover AR-15 Polymer Package of 3, Midway USA, [online], [site visited Sep. 28, 2016]. <URL: <http://www.midwayusa.com/product/3058129847/troy-industries-battle-rail-cover-ar-15-polymer-package-of-3>>.\*  
 Centurion Arms CMR Rail Covers, AIM Surplus, [online], [site visited Sep. 28, 2016]. <URL: <http://www.aimsurplus.com/product.aspx?groupid=1359&name=Centurion+Arms+CMR+Rail+Covers>>.\*

\* cited by examiner

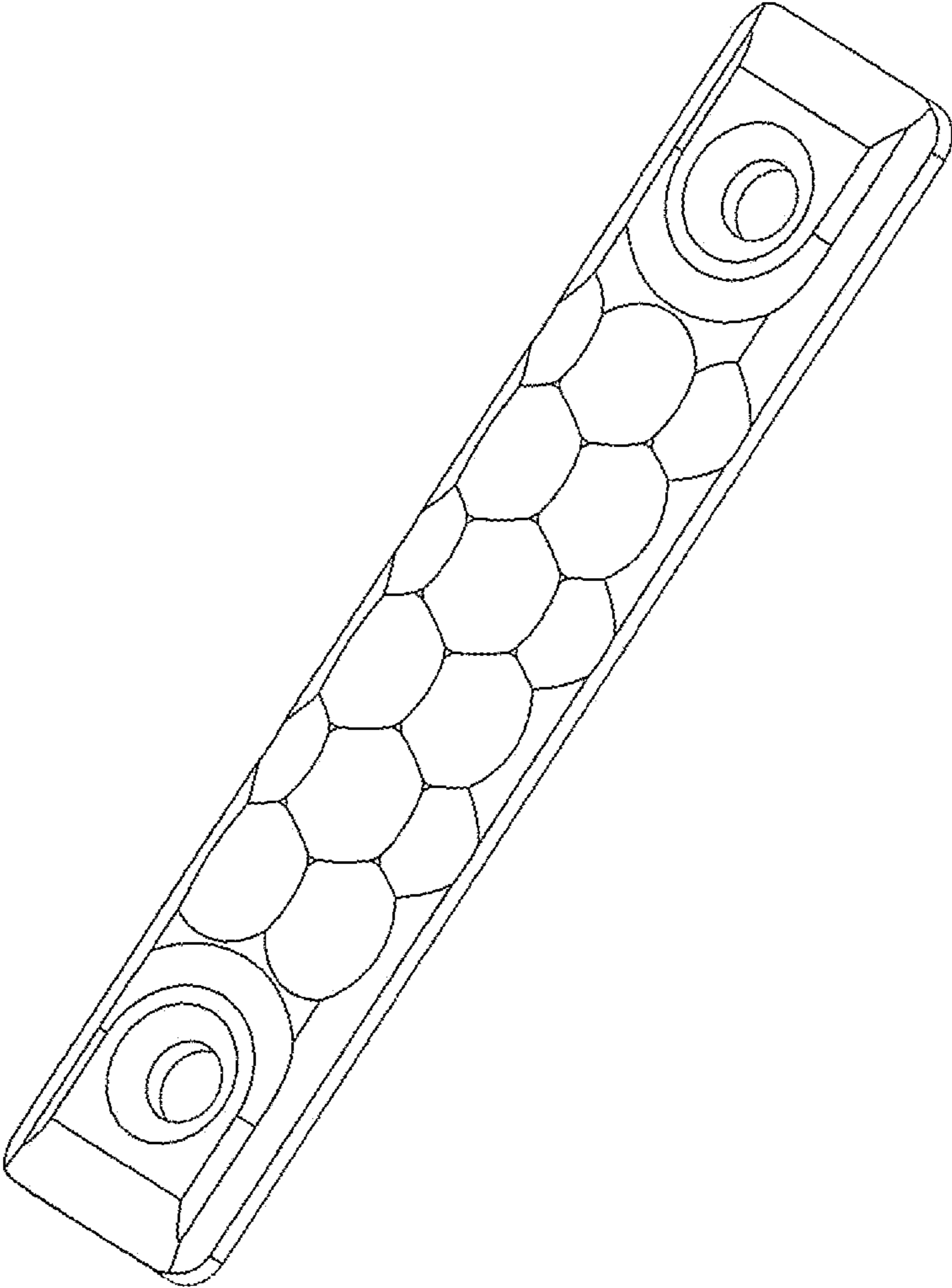

FIG. 1

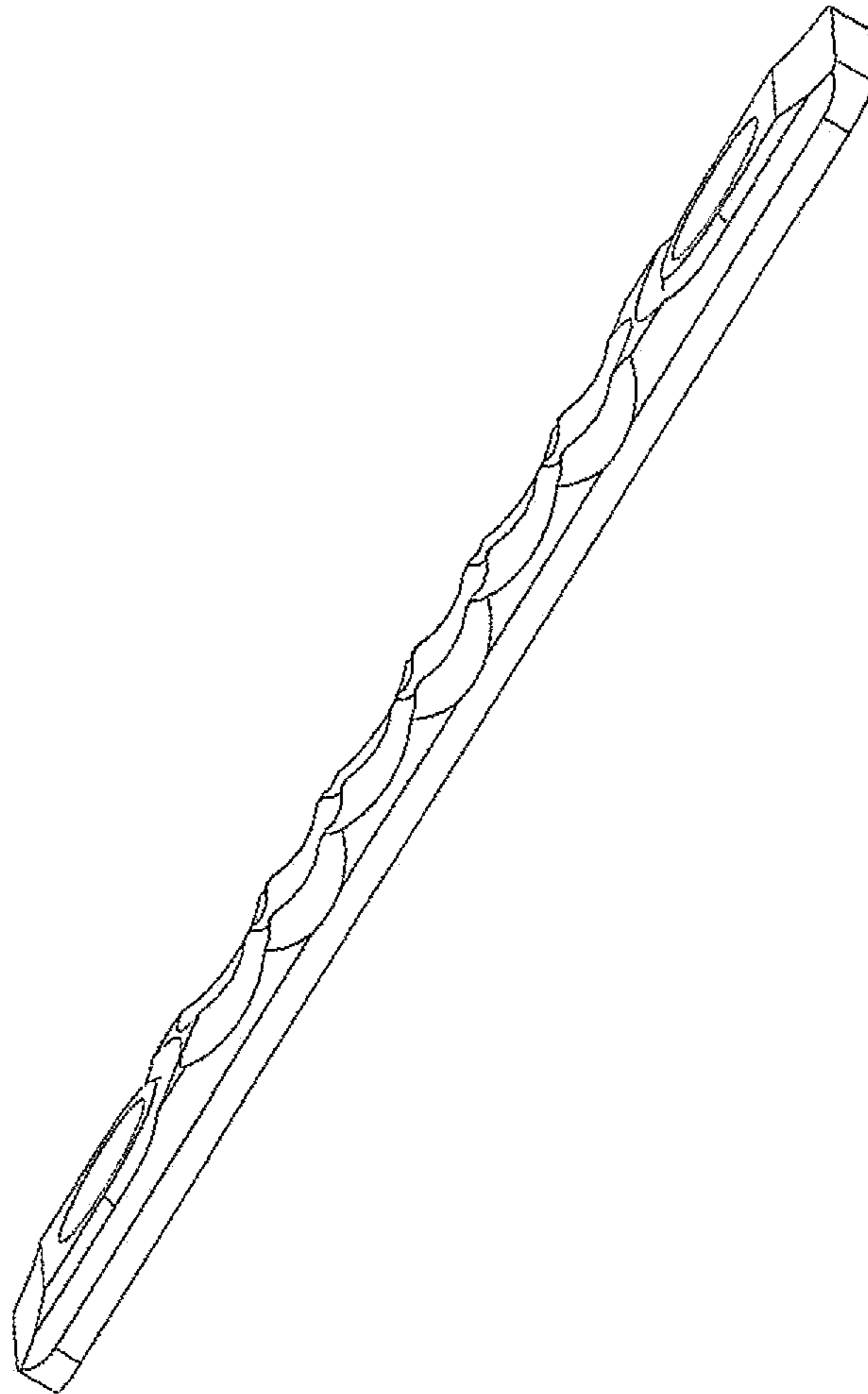

FIG. 2

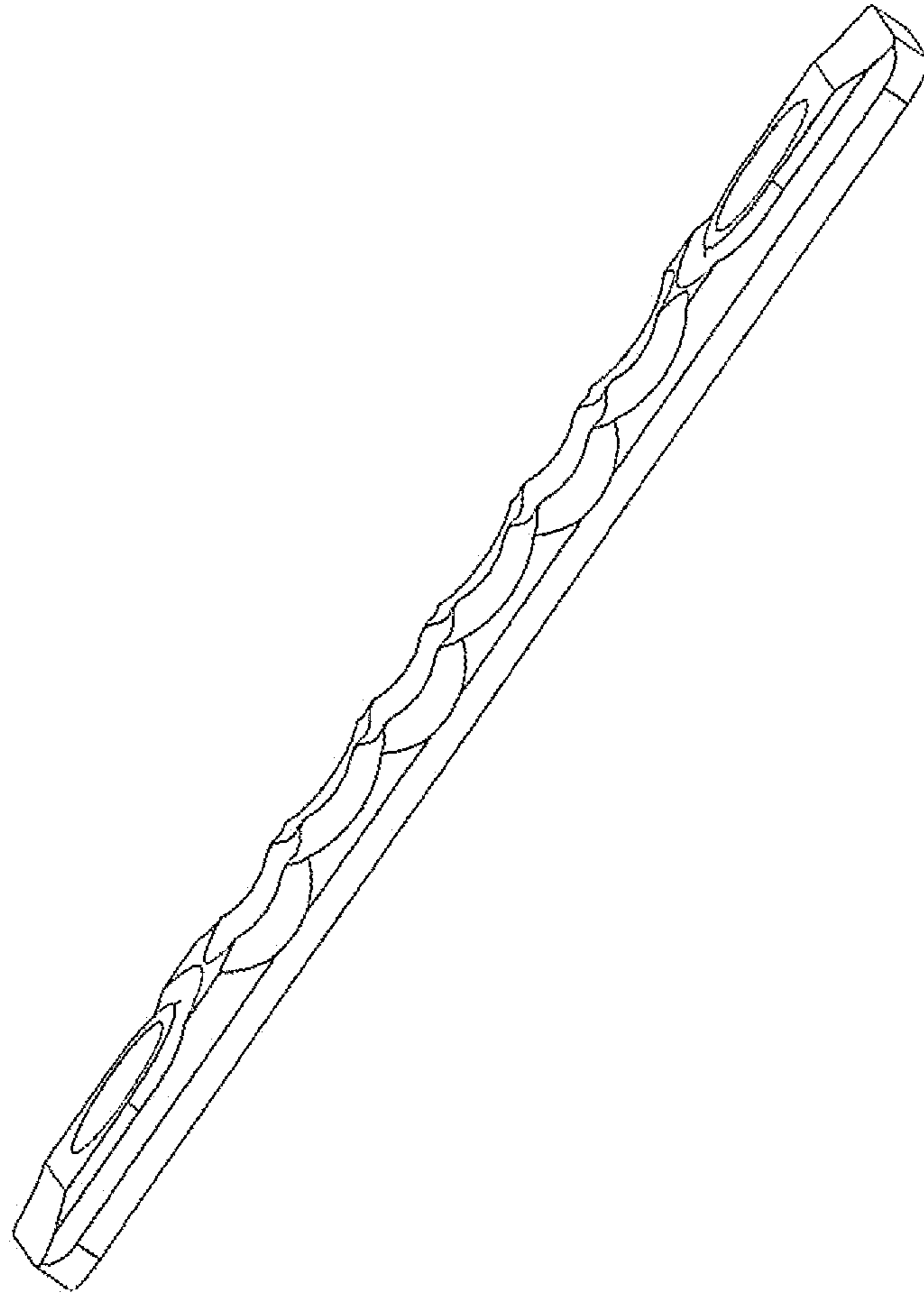

FIG. 3

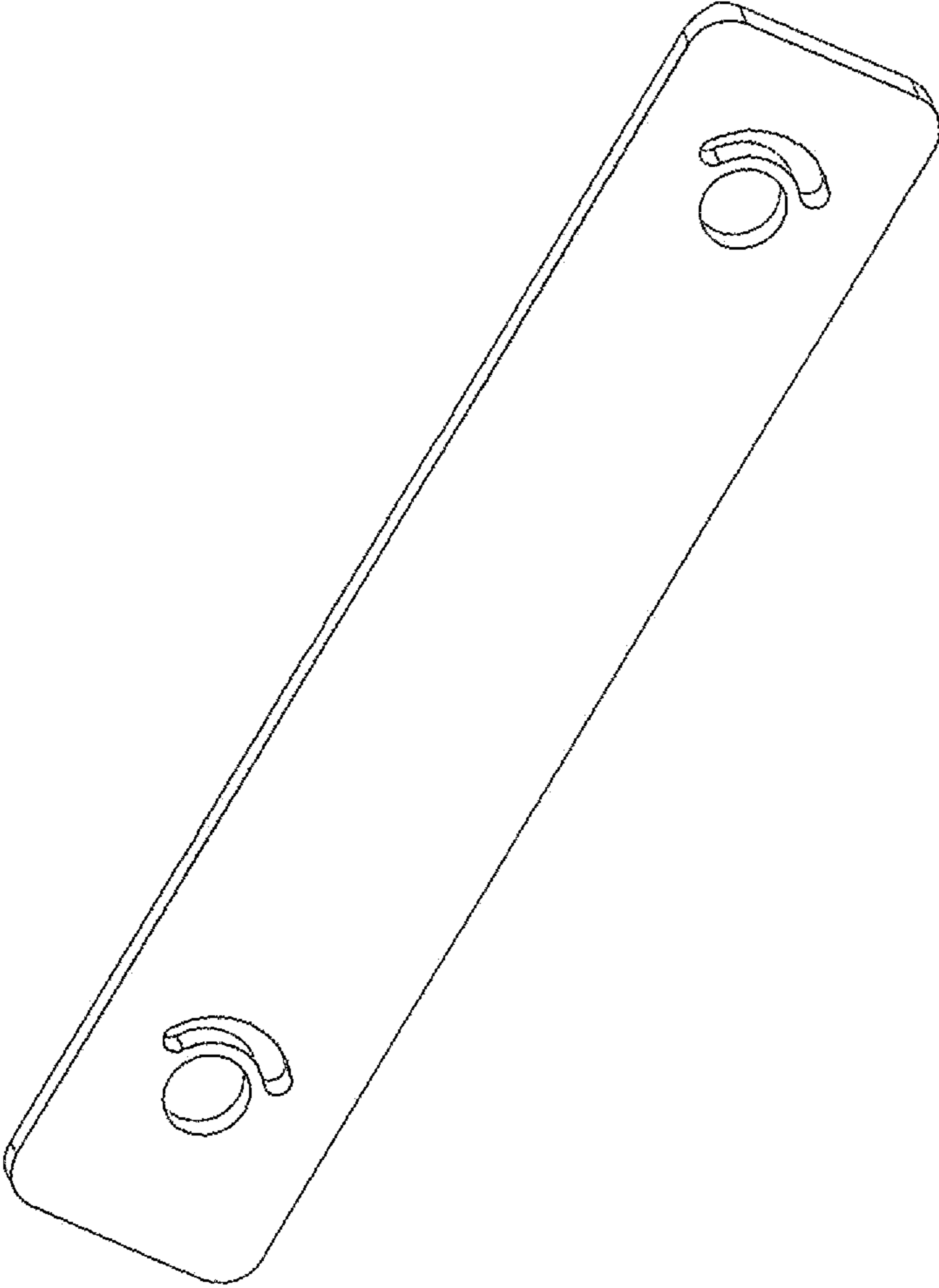

FIG. 4

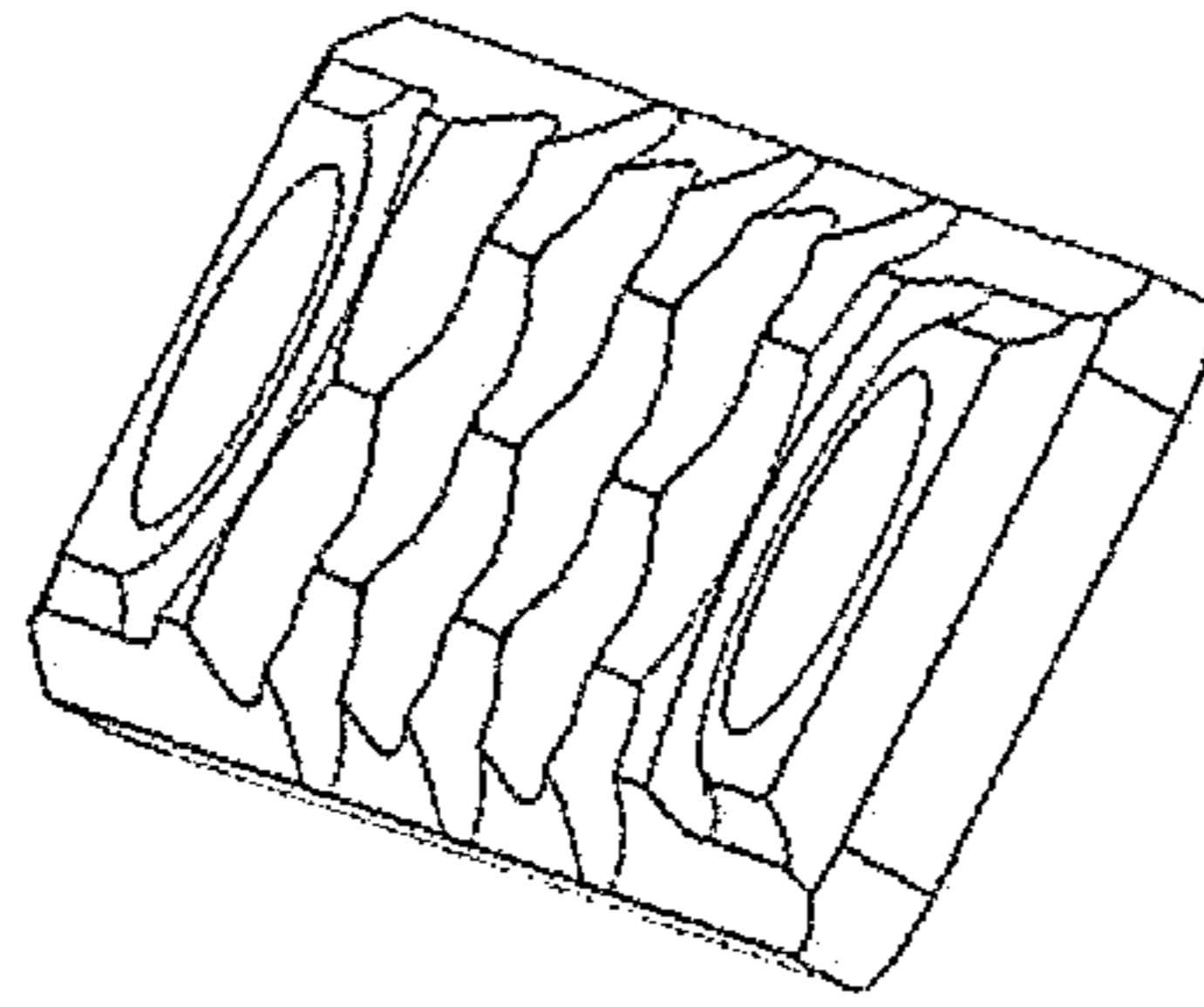

FIG. 5

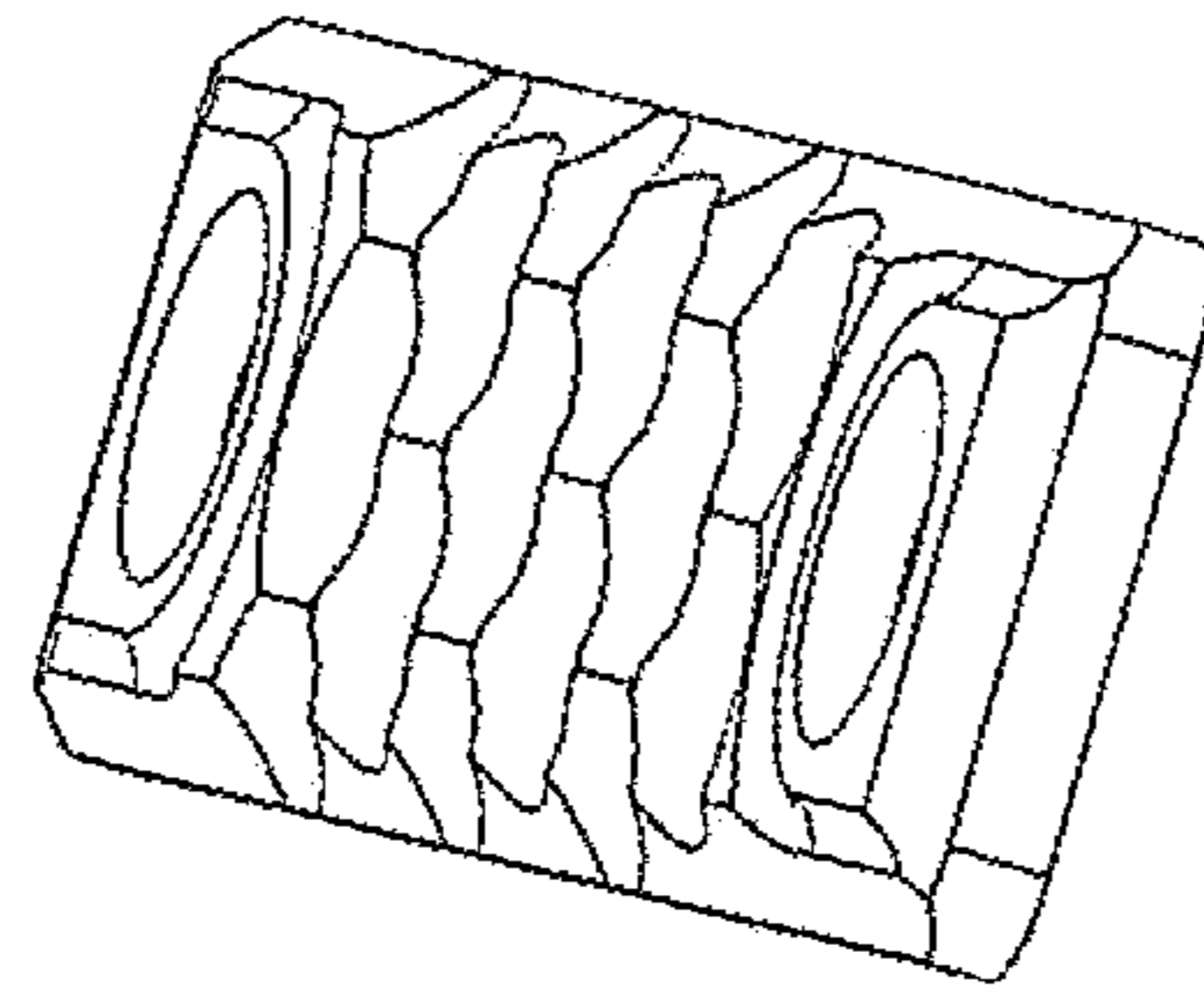

FIG. 6



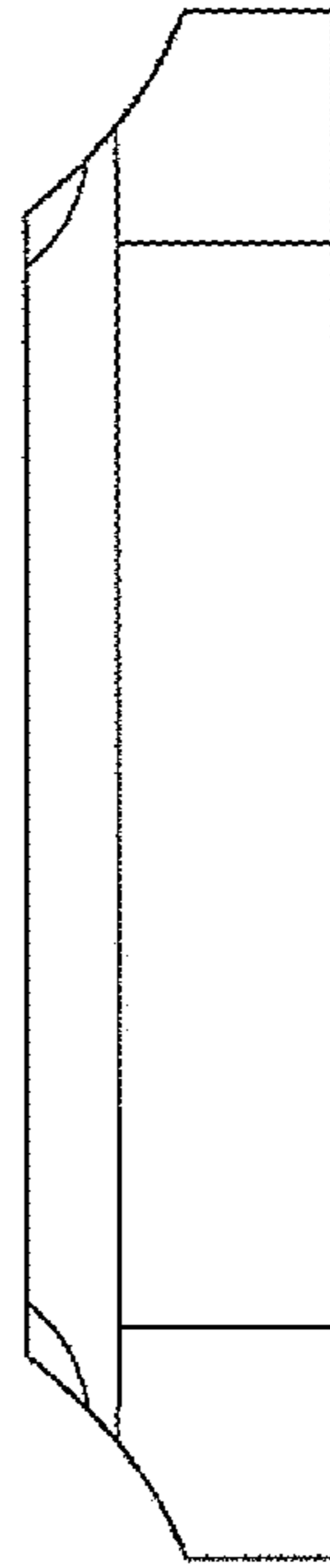

FIG. 7

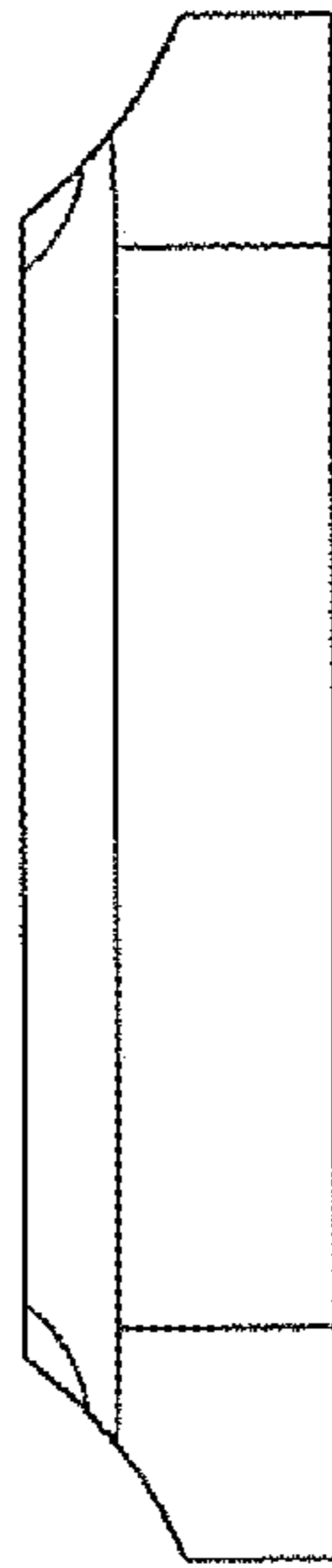

FIG. 8

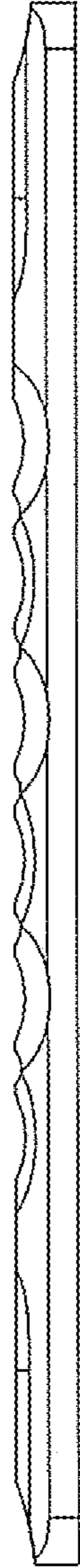

FIG. 9



FIG. 10

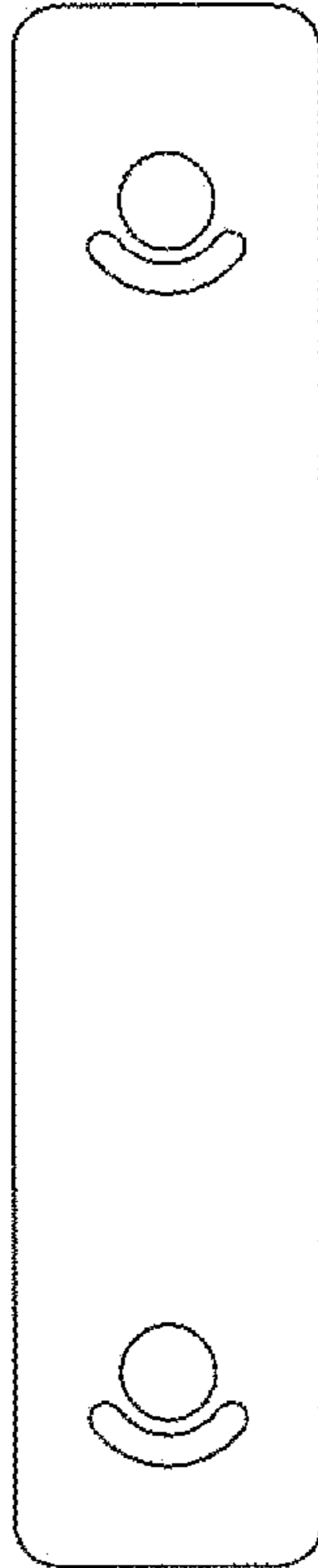

FIG. 11

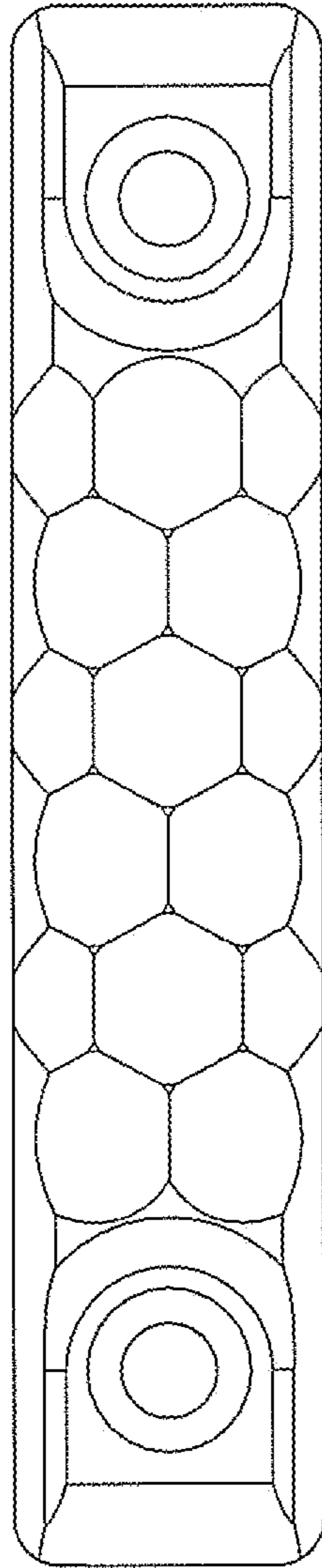

FIG. 12

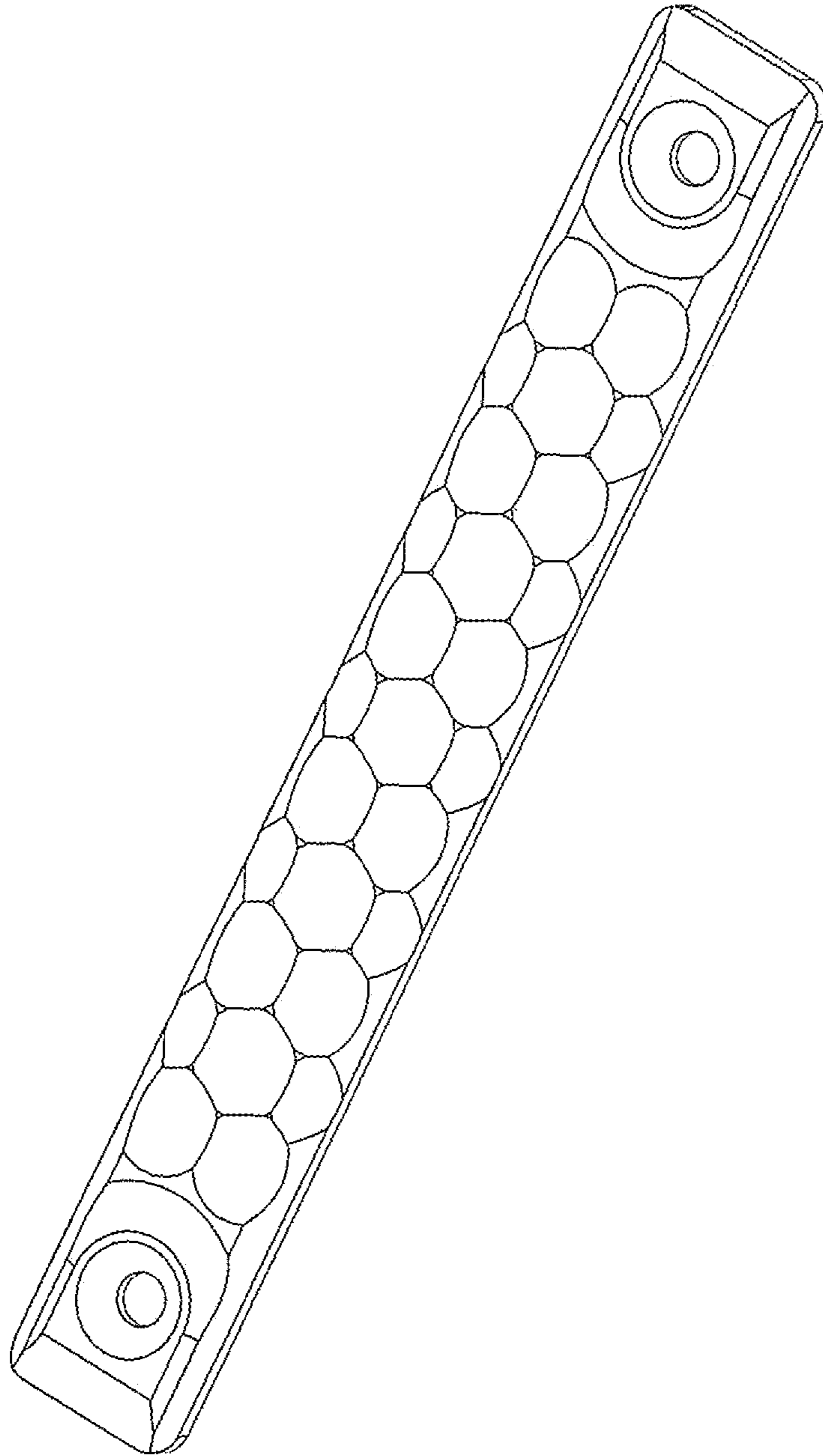

FIG. 13

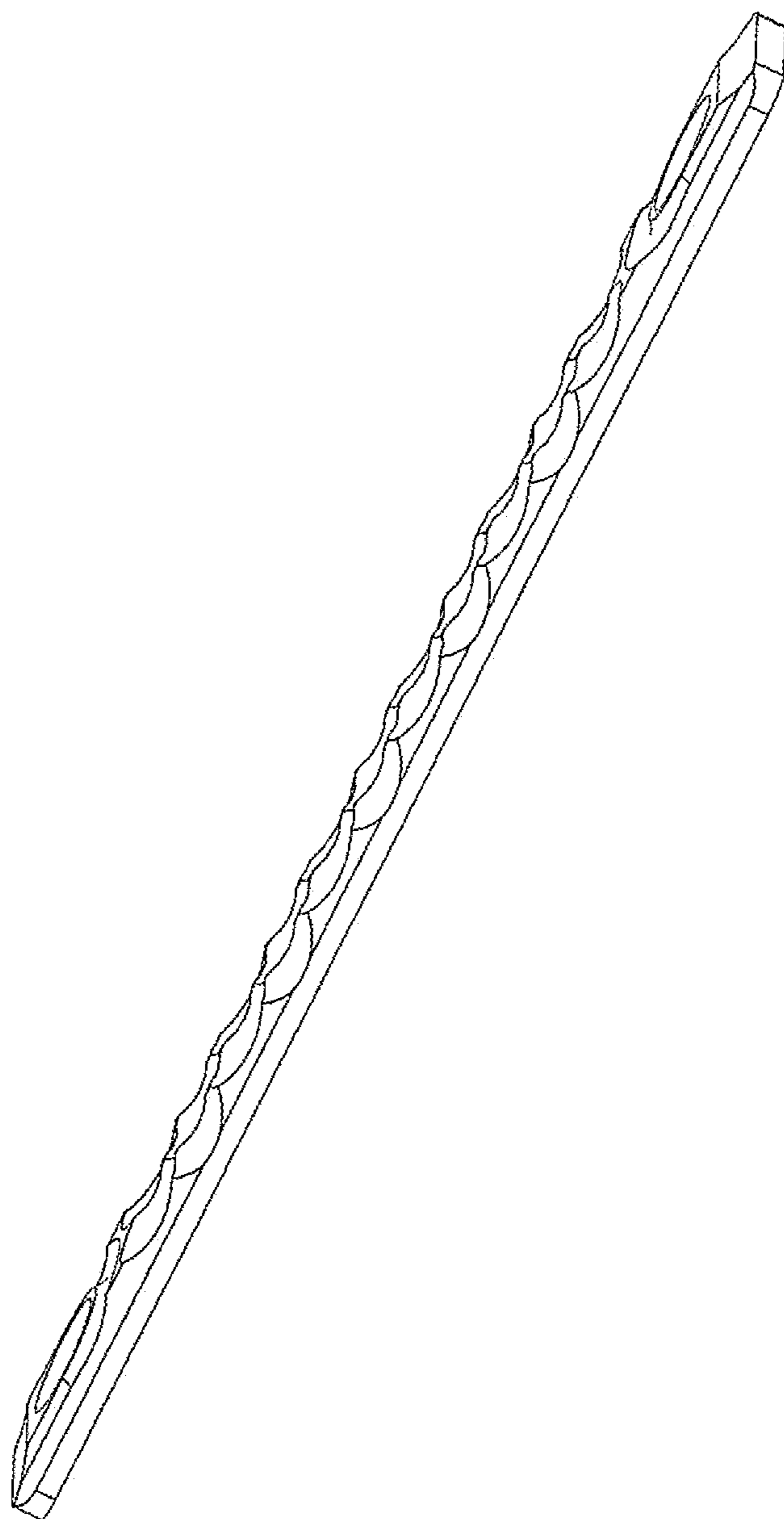

FIG. 14



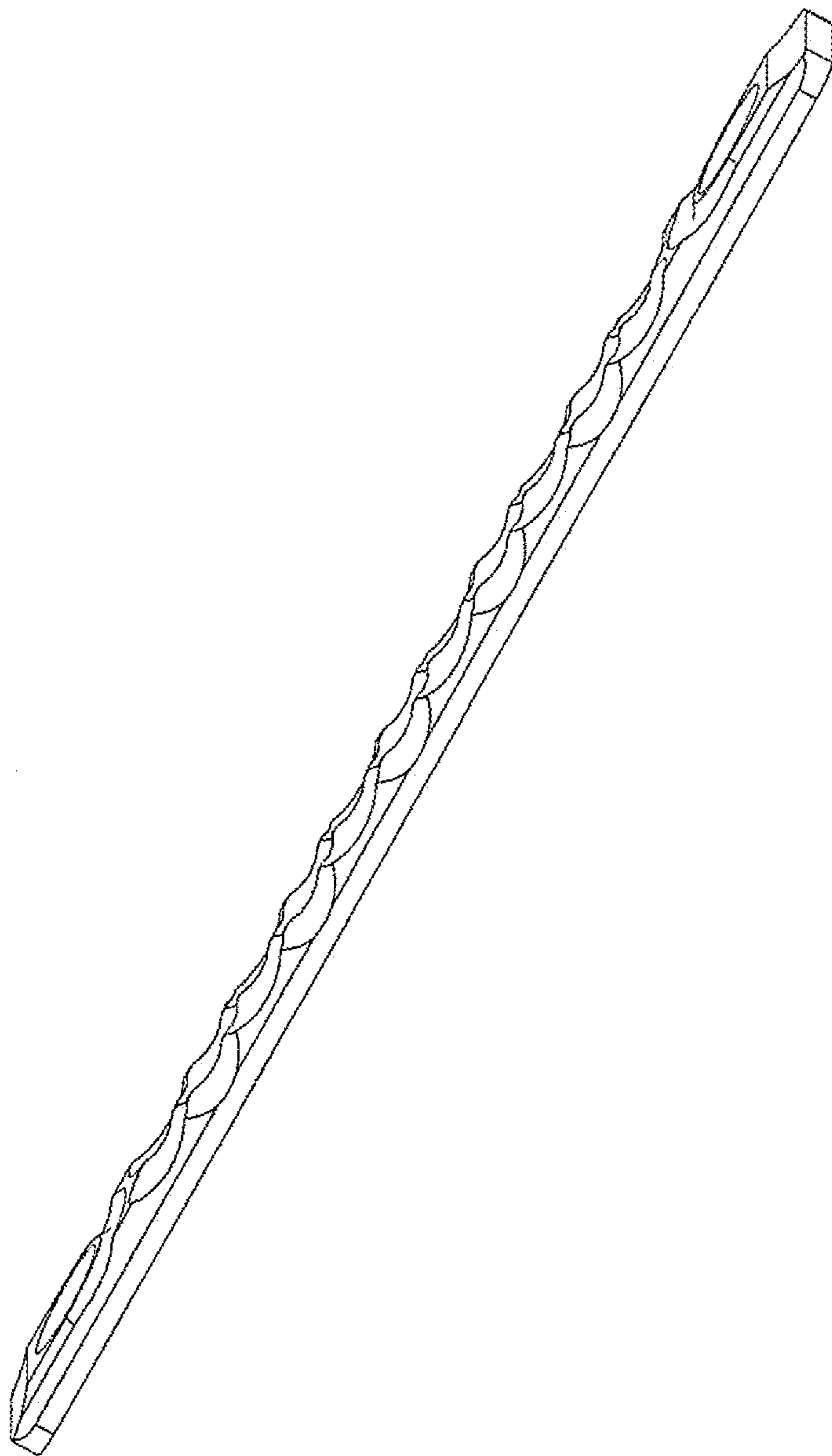

FIG. 15

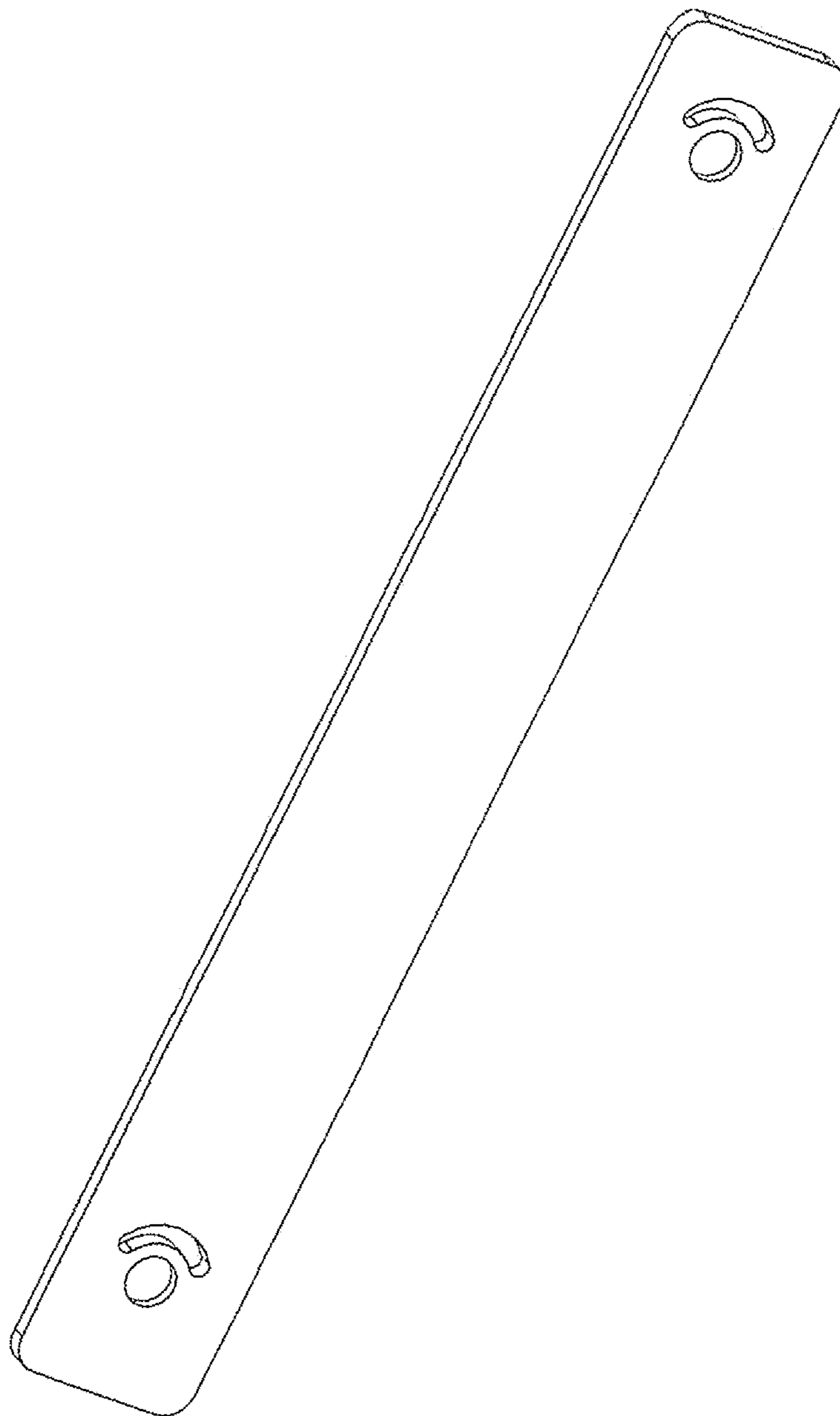

FIG. 16

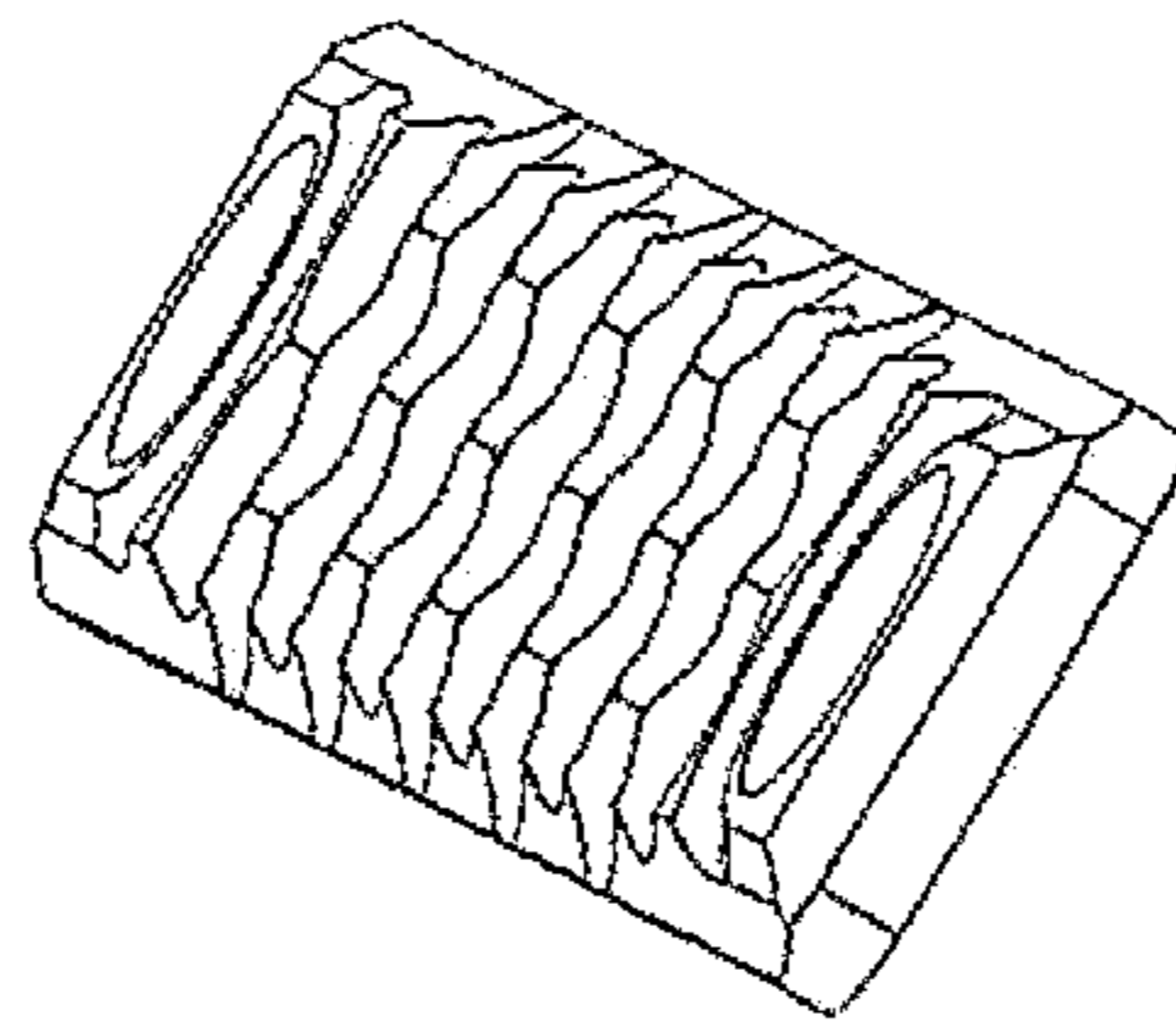

FIG. 17

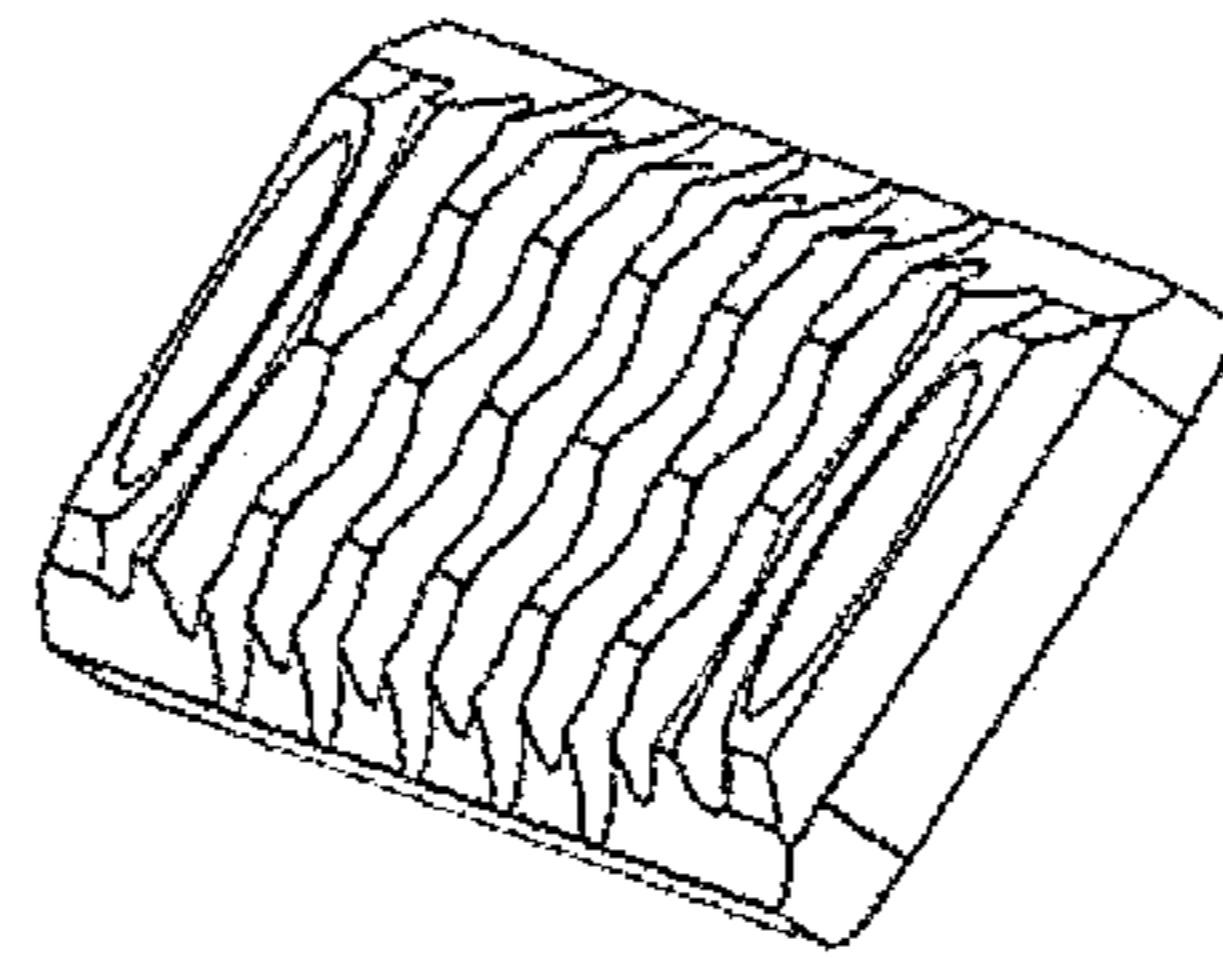

FIG. 18

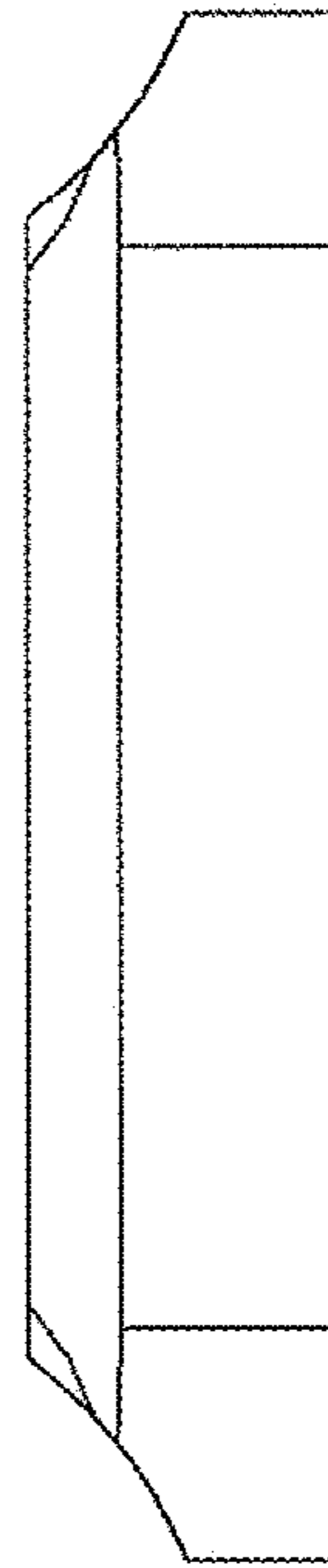

FIG. 19

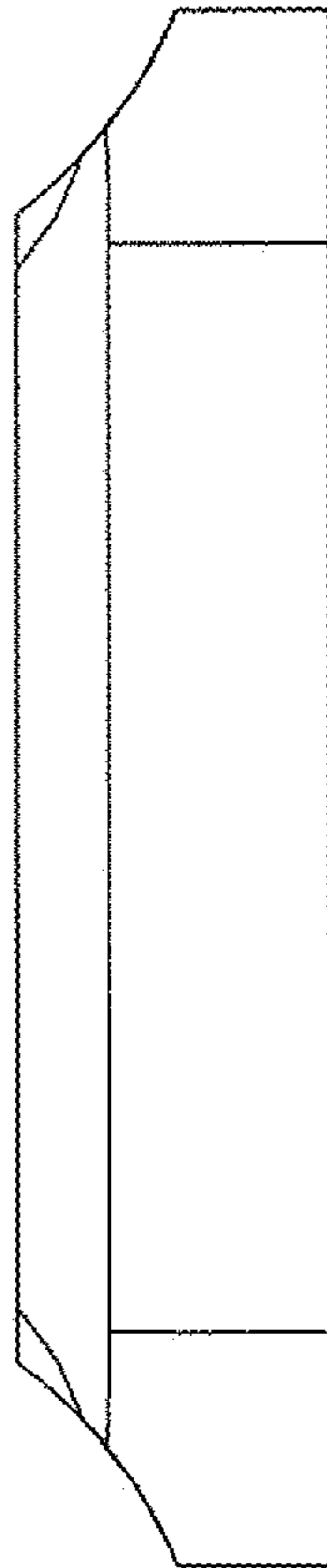

FIG. 20

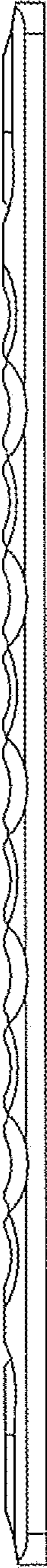

FIG. 21

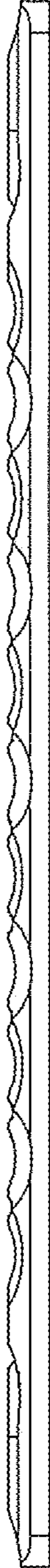

FIG. 22





FIG. 23

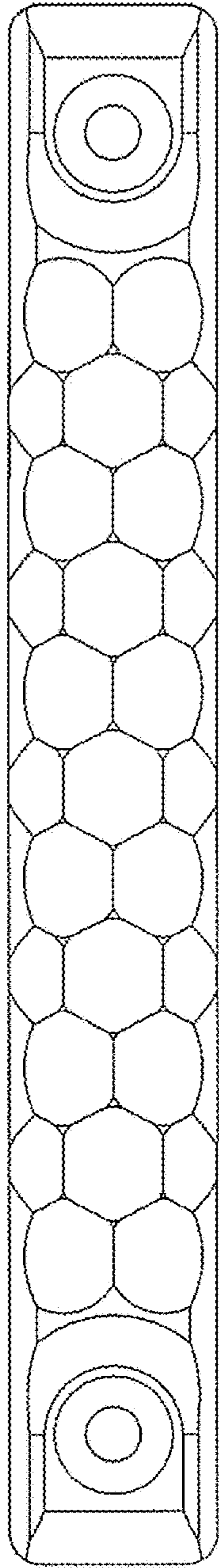

FIG. 24