



US00D774616S

(12) **United States Design Patent** (10) **Patent No.:** **US D774,616 S**
Barrett (45) **Date of Patent:** **** Dec. 20, 2016**

(54) **HANDGUARD FOR A FIREARM**

- (71) Applicant: **Ronnie Barrett**, Murfreesboro, TN (US)
- (72) Inventor: **Ronnie Barrett**, Murfreesboro, TN (US)
- (**) Term: **14 Years**
- (21) Appl. No.: **29/504,846**
- (22) Filed: **Oct. 9, 2014**
- (51) **LOC (10) Cl.** **22-01**
- (52) **U.S. Cl.**
USPC **D22/108**
- (58) **Field of Classification Search**
USPC D22/103, 108; D21/572-575
CPC F41C 23/10; F41C 23/14; F41C 23/16;
F41C 23/18
See application file for complete search history.

(56) **References Cited**

U.S. PATENT DOCUMENTS

| | | | |
|-----------|---|---------|----------------|
| 2,088,268 | A | 7/1937 | Lauf |
| 2,141,537 | A | 12/1938 | Laloux |
| 3,198,076 | A | 8/1965 | Stoner et al. |
| 3,342,171 | A | 9/1967 | James et al. |
| 3,386,336 | A | 6/1968 | Roy |
| 3,688,641 | A | 9/1972 | Curtis |
| 3,731,588 | A | 5/1973 | Curtis |
| 3,791,256 | A | 2/1974 | Curtis |
| 3,830,003 | A | 8/1974 | Clerke |
| 3,999,461 | A | 12/1976 | Johnson et al. |
| 4,066,000 | A | 1/1978 | Rostocil |
| 4,351,224 | A | 9/1982 | Curtis |
| 4,463,654 | A | 8/1984 | Barnes et al. |
| 4,553,469 | A | 11/1985 | Atchisson |
| 4,596,084 | A | 6/1986 | Martial |
| 4,601,123 | A | 7/1986 | Swearengen |
| 4,654,993 | A | 4/1987 | Atchisson |
| 4,663,876 | A | 5/1987 | Reaume |
| 4,693,170 | A | 9/1987 | Atchisson |

(Continued)

OTHER PUBLICATIONS

“Chapter 3: M240B Machine Gun”, Apr. 27, 2005, Globalsecurity.org.

(Continued)

Primary Examiner — Michael A Pratt

(74) *Attorney, Agent, or Firm* — Patterson Intellectual Property Law, P.C.; Ryan D. Levy

(57) **CLAIM**

What is claimed is the ornamental design for a handguard for a firearm, as shown and described.

DESCRIPTION

FIG. 1 is a top perspective view showing the handguard for a firearm of Applicant’s invention.
 FIG. 2 is a bottom perspective view of the handguard for a firearm of Applicant’s invention.
 FIG. 3 is a side view of the handguard for a firearm of Applicant’s invention.
 FIG. 4 is a side view of the handguard for a firearm of Applicant’s invention.
 FIG. 5 is a front view of the handguard for a firearm of Applicant’s invention.
 FIG. 6 is a back view of the handguard for a firearm of Applicant’s invention.
 FIG. 7 is a top view of the handguard for a firearm of Applicant’s invention.
 FIG. 8 is a bottom view of the handguard for a firearm of Applicant’s invention; and,
 FIG. 9 is a view of the handguard for a firearm of Applicant’s invention with a firearm.
 The dash-dot-dash lines shown in the Figures represent some embodiments of environmental structure and form no part of the claimed design. The dotted lines represent a firearm.

1 Claim, 4 Drawing Sheets

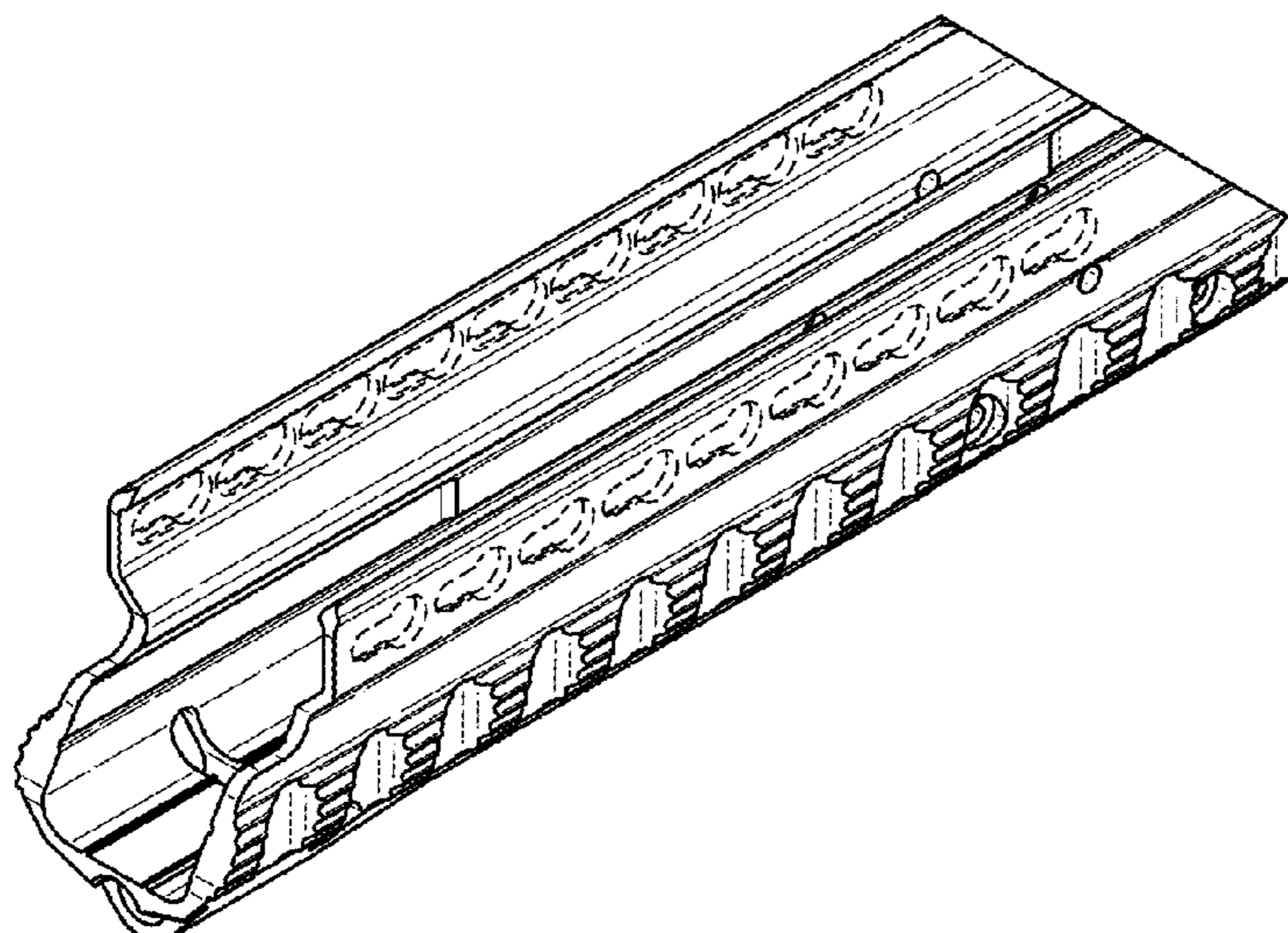

(56)

References Cited

U.S. PATENT DOCUMENTS

4,872,391 A 10/1989 Stoner
 4,893,547 A 1/1990 Atchisson
 5,195,226 A 3/1993 Bornancini
 5,256,100 A 10/1993 Wang
 5,440,099 A 8/1995 Smith
 6,695,676 B2 2/2004 Blake
 7,258,055 B1 8/2007 Javorsky
 7,356,958 B2 4/2008 Weir
 7,676,977 B1 3/2010 Cahill
 7,937,877 B2 5/2011 Barrett
 7,950,178 B1 5/2011 Landies
 8,104,213 B2 1/2012 Keng
 8,316,570 B2 11/2012 Potterfield
 8,402,684 B1 3/2013 Beltz
 D682,973 S 5/2013 KasanJian-King
 8,448,369 B2 5/2013 Hinds, Jr.
 8,496,212 B2 7/2013 Keng
 D747,426 S * 1/2016 Cheng D22/108
 D750,188 S * 2/2016 Fitzpatrick D22/108
 9,341,441 B2 * 5/2016 Cheng F41C 27/00
 2003/0196366 A1 10/2003 Beretta
 2007/0033850 A1 2/2007 Murello et al.
 2008/0092732 A1 4/2008 Becker
 2008/0229642 A1 9/2008 Hu
 2009/0126250 A1 5/2009 Keng
 2011/0283582 A1 11/2011 Hunter et al.
 2012/0144985 A1 6/2012 Beville et al.

2012/0198990 A1* 8/2012 Brittin F41A 5/26
 89/191.01
 2014/0115940 A1 5/2014 Bonelli
 2014/0190059 A1 7/2014 Ballard
 2014/0331538 A1* 11/2014 Spiegelhauer F41C 23/16
 42/71.01
 2015/0020429 A1 1/2015 Savoy
 2015/0198409 A1 7/2015 Desomma
 2015/0241160 A1 8/2015 McGinty
 2016/0040948 A1 2/2016 Barrett

OTHER PUBLICATIONS

M240LW Test Fire, YouTube video published on Aug. 19, 2011, at <https://www.youtube.com/watch?v=8xusEBOCeds>.
 Accuracy International Brochure, published on Jan. 14, 2014, at http://www.accuracyinternational.com/default/public/media/pdf/AI_brochure_download_2014_LR.pdf.
 PCT Application No. PCT/US2016/025294 filed Mar. 31 2016 to Barrett et al.
 PCT Application No. PCT/US2015/044642 filed Aug. 11, 2015 to Barrett et al.
 U.S. Appl. No. 29/504,851, filed Oct. 9, 2014 to Barrett.
 U.S. Appl. No. 14/823,111, filed Aug. 11, 2015 to Barrett.
 U.S. Appl. No. 29/504,850, filed Oct. 9, 2014 to Barrett.
 U.S. Appl. No. 29/504,849, filed Oct. 9, 2014 to Barrett.
 U.S. Appl. No. 15/086,876, filed Mar. 31, 2016 to Barrett et al.

* cited by examiner

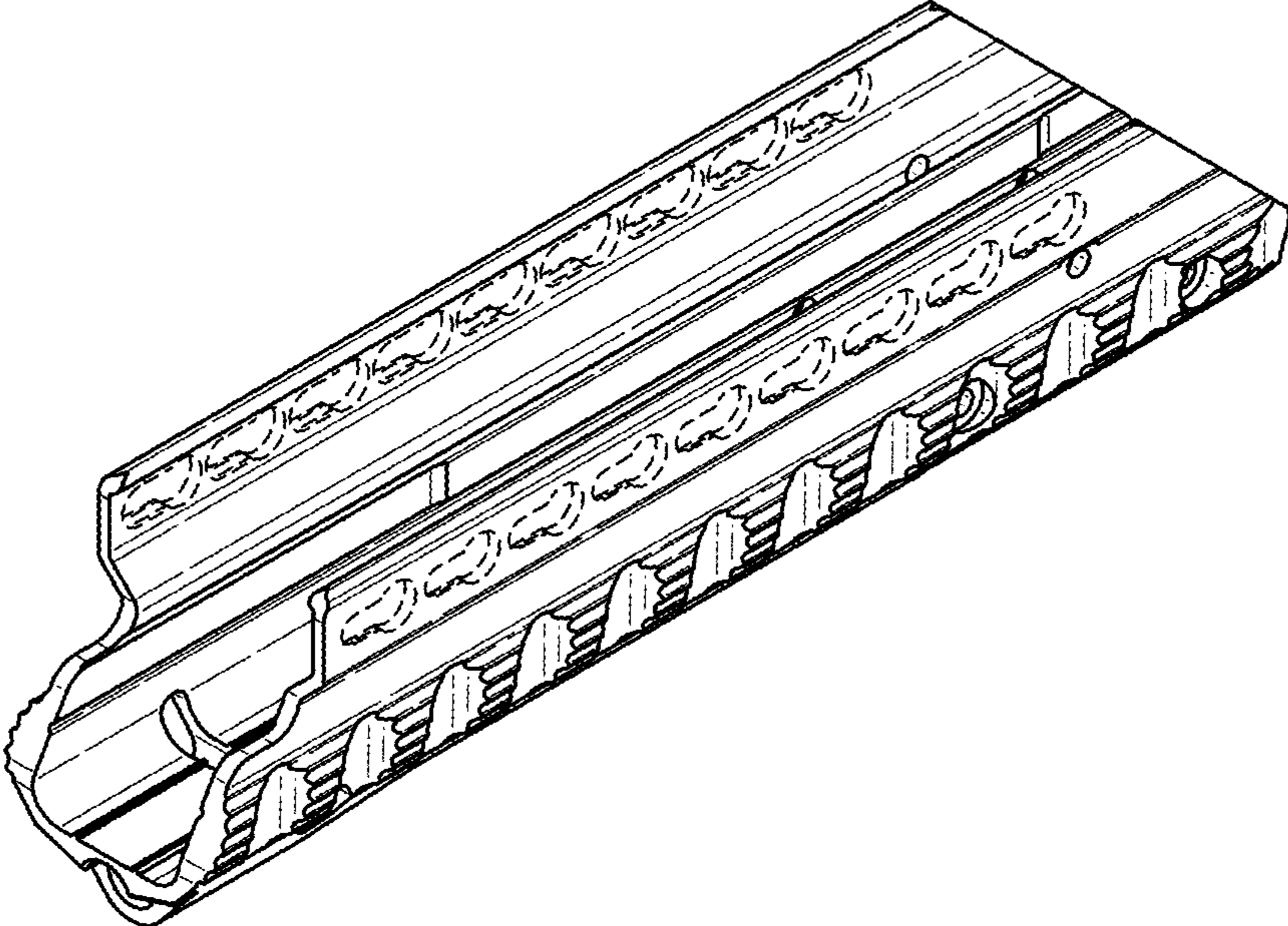

FIG. 1

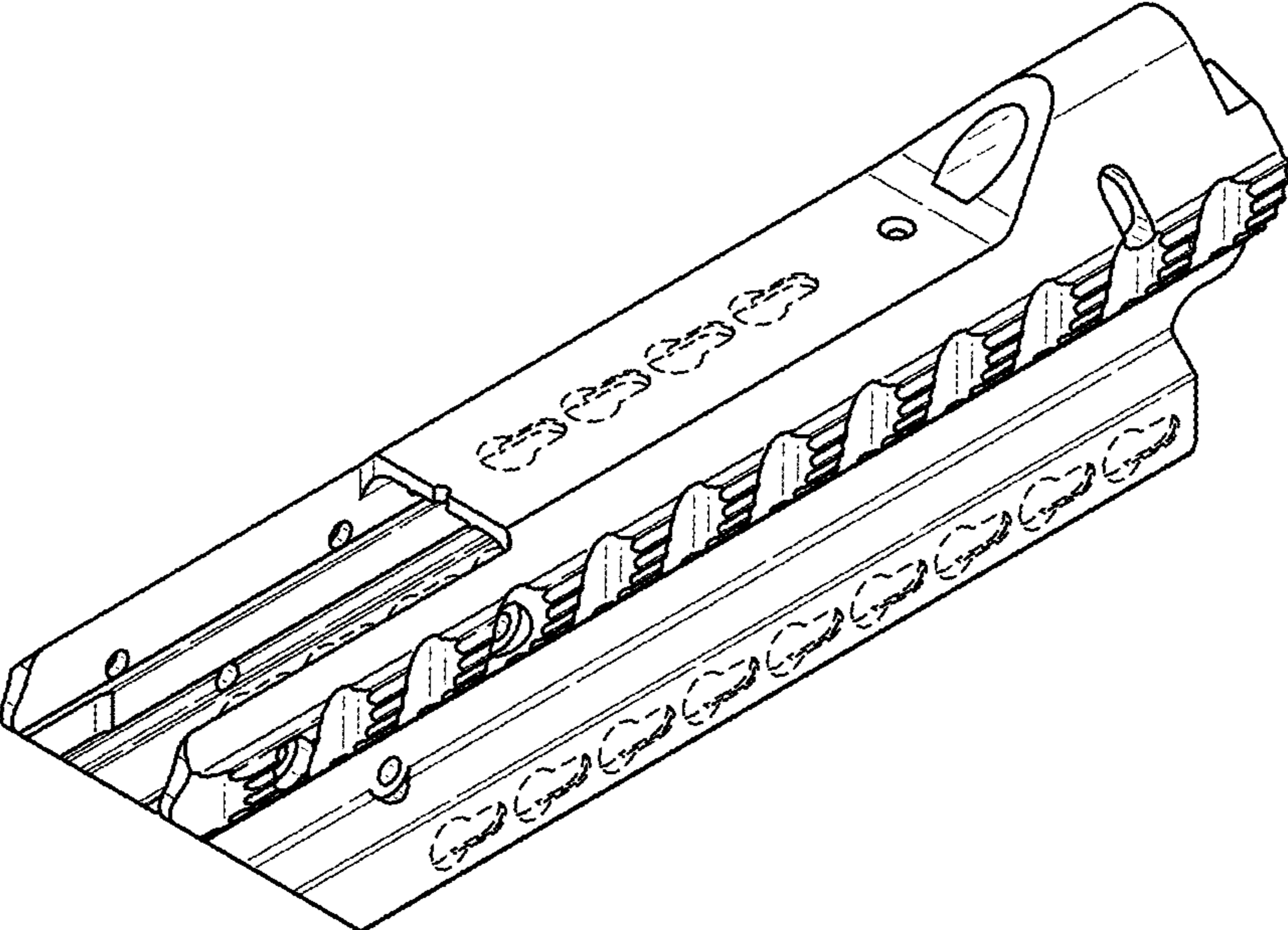

FIG. 2

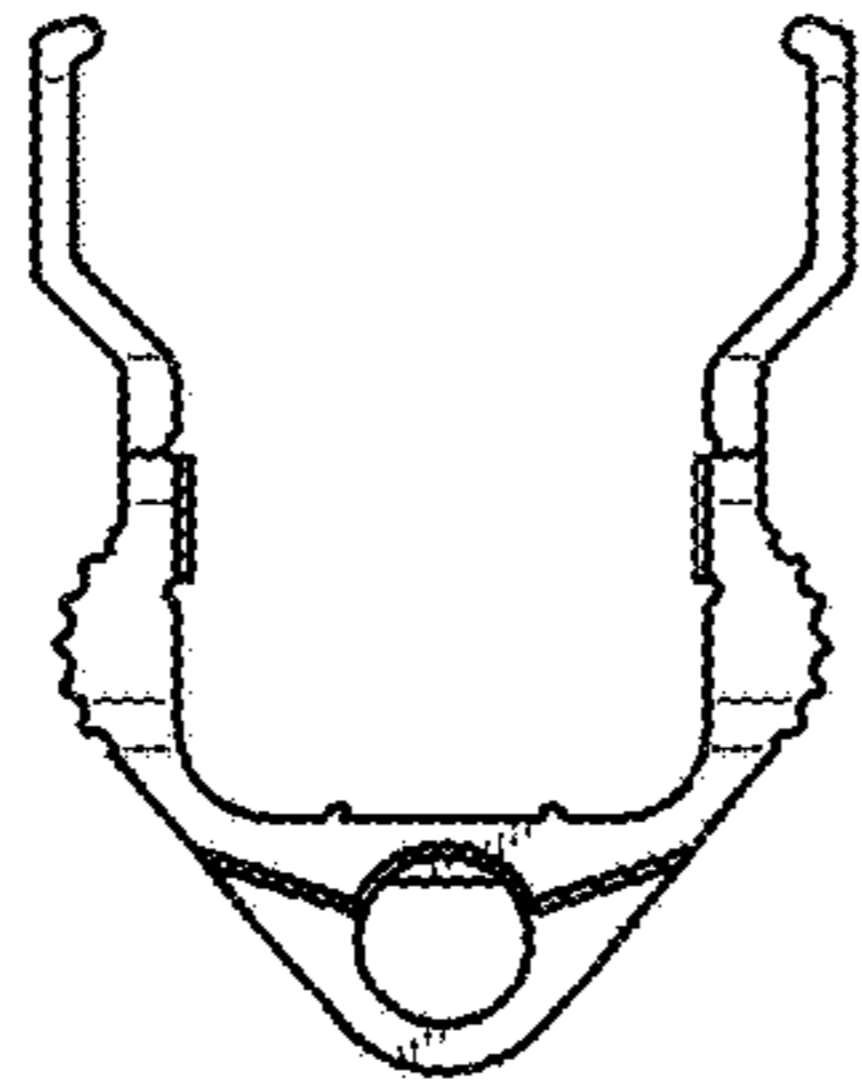

FIG. 5

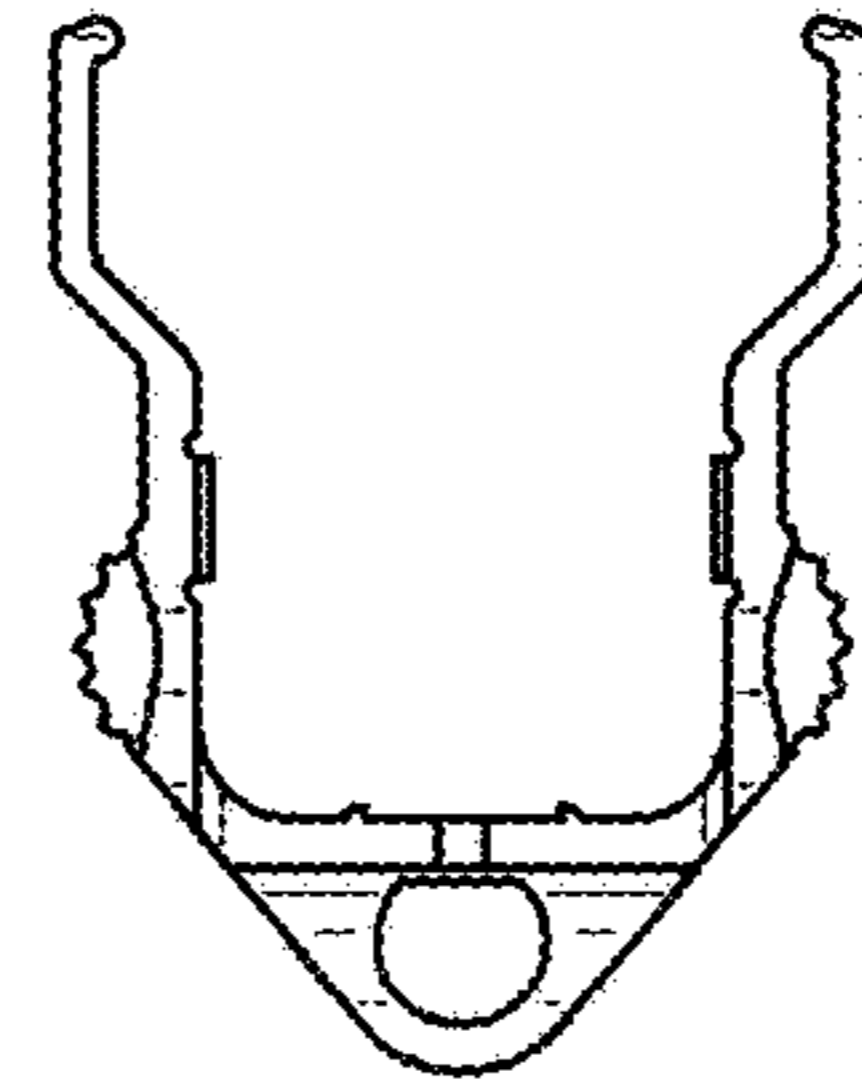

FIG. 6

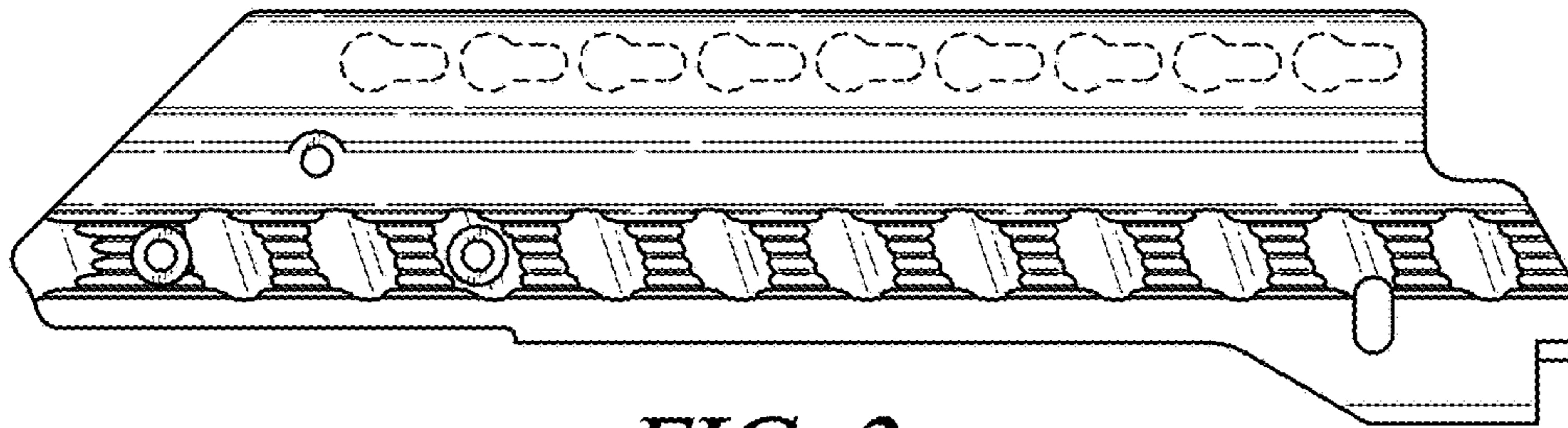

FIG. 3

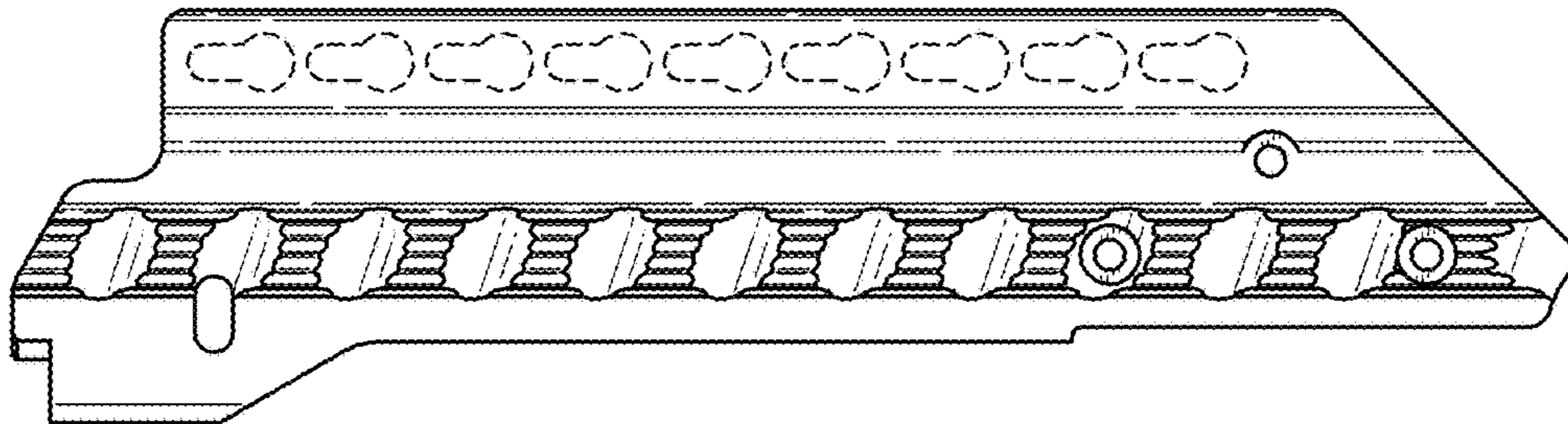

FIG. 4

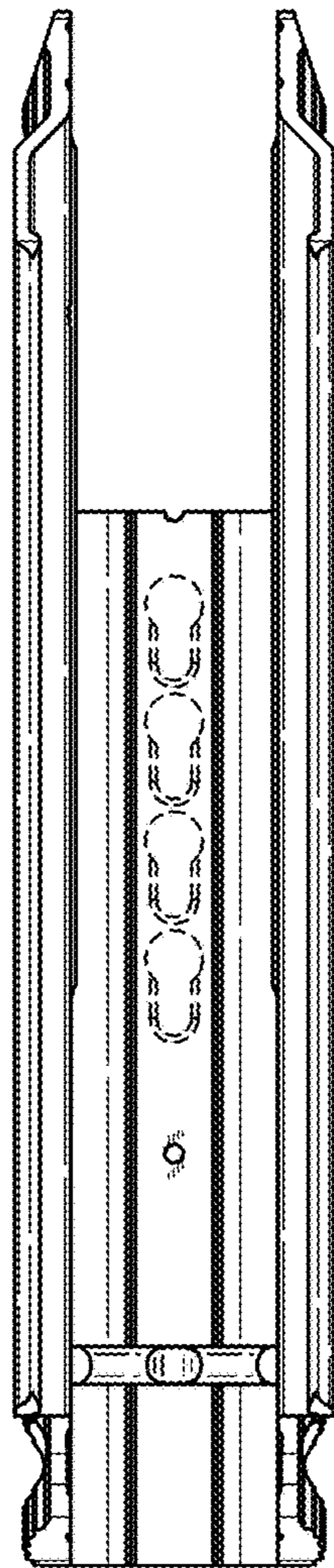

FIG. 7

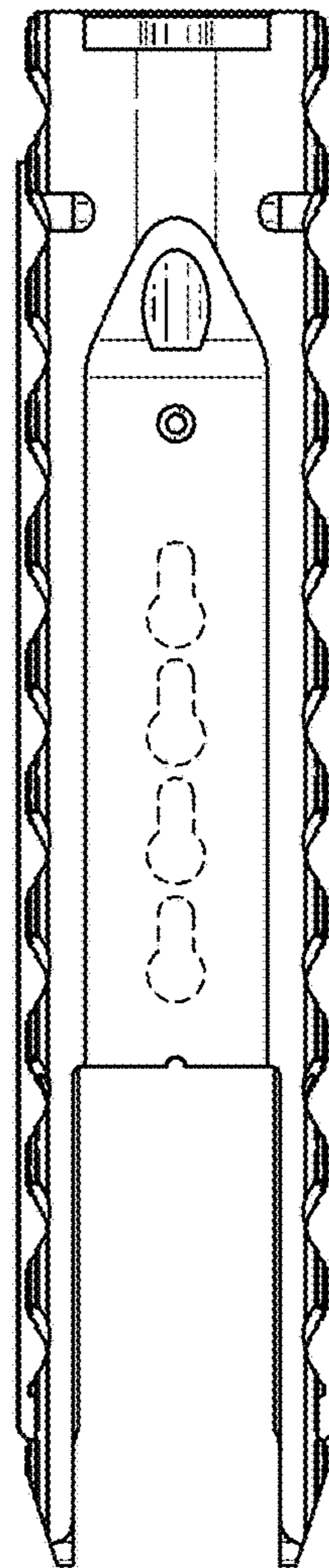

FIG. 8

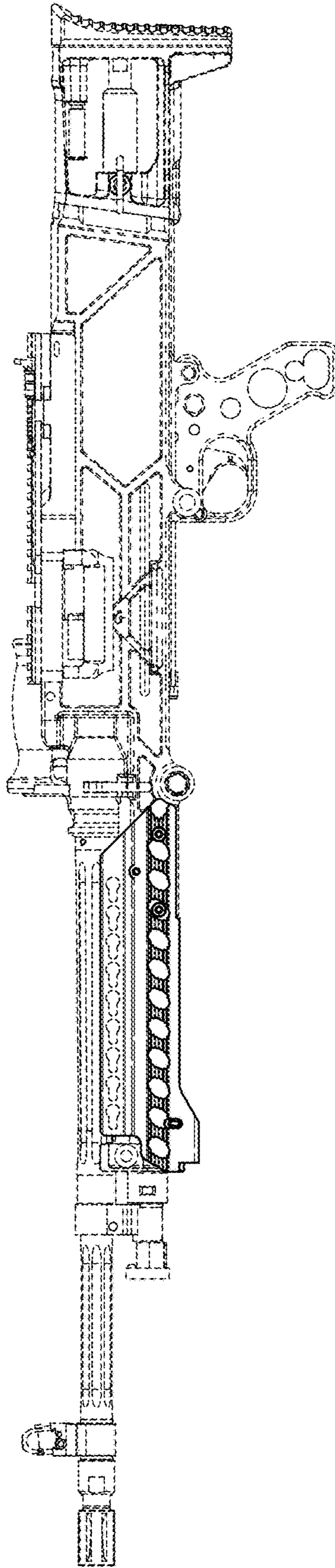

FIG. 9