



US00D774613S

(12) **United States Design Patent** (10) **Patent No.:** **US D774,613 S**
Kirkpatrick (45) **Date of Patent:** **** Dec. 20, 2016**

(54) **SKI POLE BASKET**

(71) Applicant: **Kristopher Kirkpatrick**, Berkeley, CA (US)

(72) Inventor: **Kristopher Kirkpatrick**, Berkeley, CA (US)

(73) Assignee: **Basket Buds, LLC**, Berkeley, CA (US)

(**) Term: **15 Years**

(21) Appl. No.: **29/527,272**

(22) Filed: **May 18, 2015**

(51) **LOC (10) Cl.** **21-02**

(52) **U.S. Cl.**
USPC **D21/775**

(58) **Field of Classification Search**
USPC D21/771, 775; D3/7, 12, 16, 5, 6;
280/819-824; 16/430, 421; 135/76
CPC A63C 11/24; A63C 11/005; A63C 11/222
See application file for complete search history.

(56) **References Cited**

U.S. PATENT DOCUMENTS

8,973,946 B2 *	3/2015	Carr	A63C 11/222 280/816
9,375,631 B2 *	6/2016	Ferraro	A63C 11/005
2006/0163866 A1 *	7/2006	Fleming	A63C 11/24 280/824
2008/0169012 A1 *	7/2008	Gillanders	A63C 11/24 135/84

(Continued)

Primary Examiner — Zenia Bennett

(74) *Attorney, Agent, or Firm* — Auror Consulting LLC

(57) **CLAIM**

The ornamental design for a ski pole basket, as shown and described.

DESCRIPTION

FIG. 1 is a front elevation view of a ski pole basket in accordance with a first embodiment of the present design; FIG. 2 is a right side elevation view thereof; FIG. 3 is a rear elevation view thereof; FIG. 4 is a left side elevation view thereof; FIG. 5 is a top elevation view thereof; FIG. 6 is a bottom elevation view thereof; FIG. 7 is a top perspective view thereof; FIG. 8 is a bottom perspective view thereof; FIG. 9 is a cross-sectional view thereof; FIG. 10 is a front elevation view of a ski pole basket in accordance with a second embodiment of the present design; FIG. 11 is a right side elevation view thereof; FIG. 12 is a rear elevation view thereof; FIG. 13 is a left side elevation view thereof; FIG. 14 is a top elevation view thereof; FIG. 15 is a bottom elevation view thereof; FIG. 16 is a top perspective view thereof; FIG. 17 is a bottom perspective view thereof; FIG. 18 is a cross-sectional view thereof; FIG. 19 is a front elevation view of a ski pole basket in accordance with a third embodiment of the present design; FIG. 20 is a right side elevation view thereof; FIG. 21 is a rear elevation view thereof; FIG. 22 is a left side elevation view thereof; FIG. 23 is a top elevation view thereof; FIG. 24 is a bottom elevation view thereof; FIG. 25 is a top perspective view thereof; FIG. 26 is a bottom perspective view thereof; and, FIG. 27 is a cross-sectional view thereof.

The broken lines are shown in the views for illustrative purposes only and form no part of the claimed design.

1 Claim, 27 Drawing Sheets

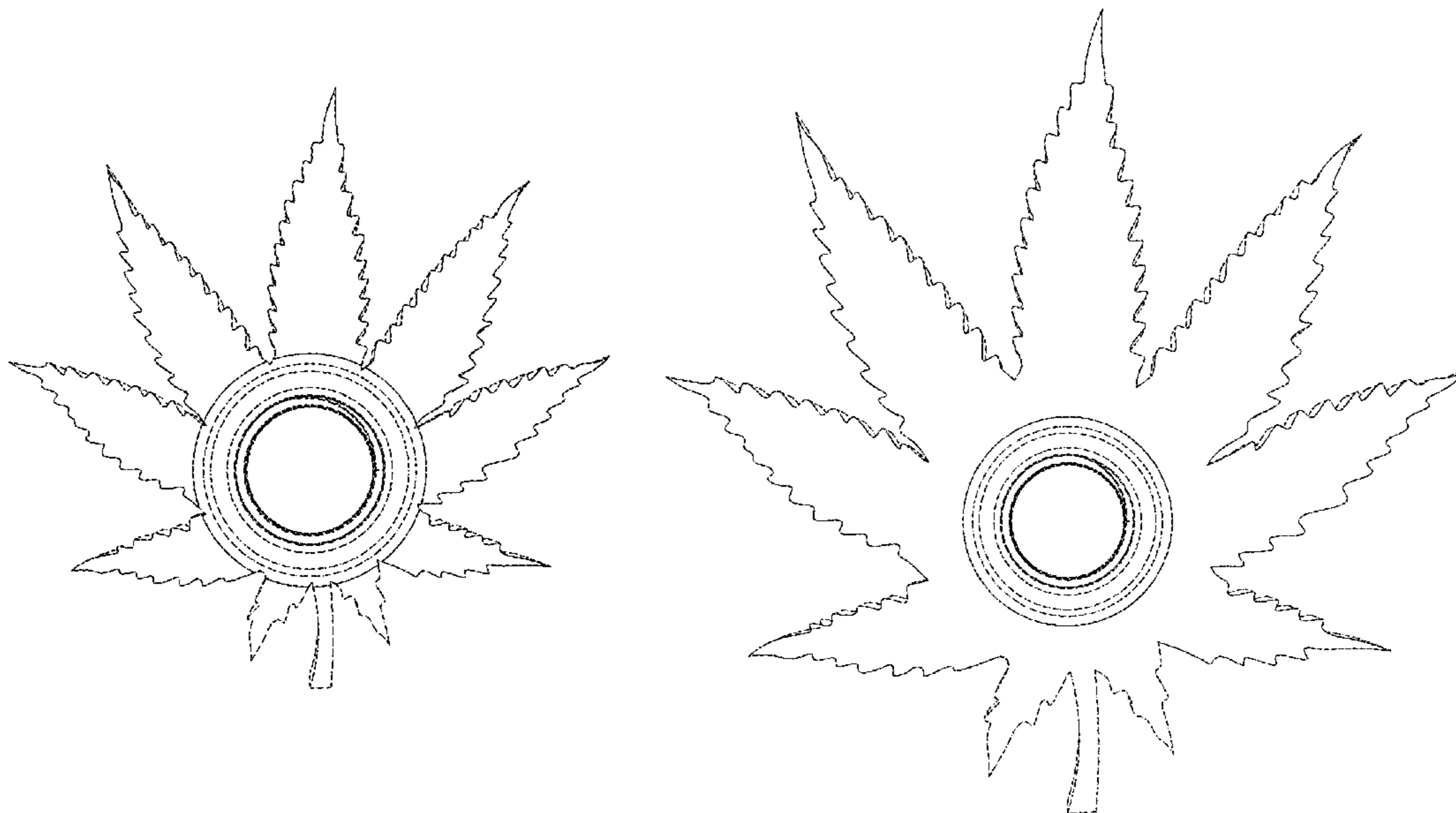

(56)

References Cited

U.S. PATENT DOCUMENTS

2009/0058064	A1 *	3/2009	Ford III	A63C 11/24 280/824
2009/0194986	A1 *	8/2009	Lenhart	A63C 11/24 280/824
2011/0084472	A1 *	4/2011	Karlof	A63C 11/24 280/824
2011/0187091	A1 *	8/2011	Nickaes	A45B 9/04 280/821
2011/0187092	A1 *	8/2011	Nickaes	A63C 11/24 280/824
2013/0264810	A1 *	10/2013	Carr	A63C 11/222 280/821

* cited by examiner

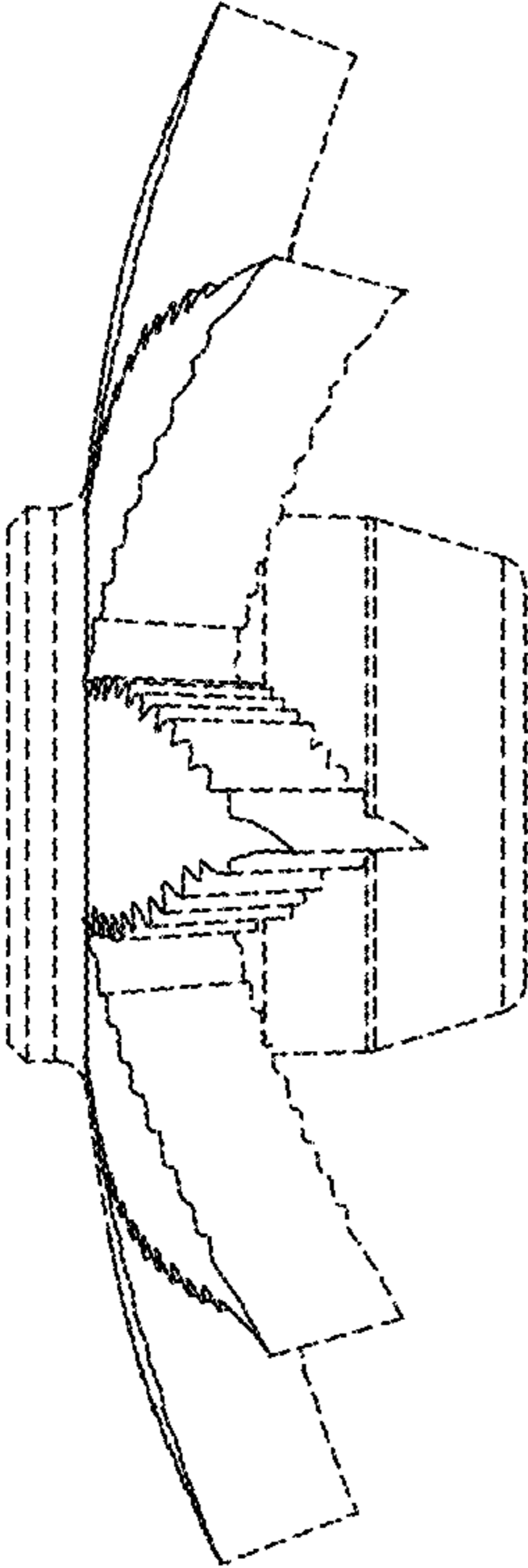

FIG. 1

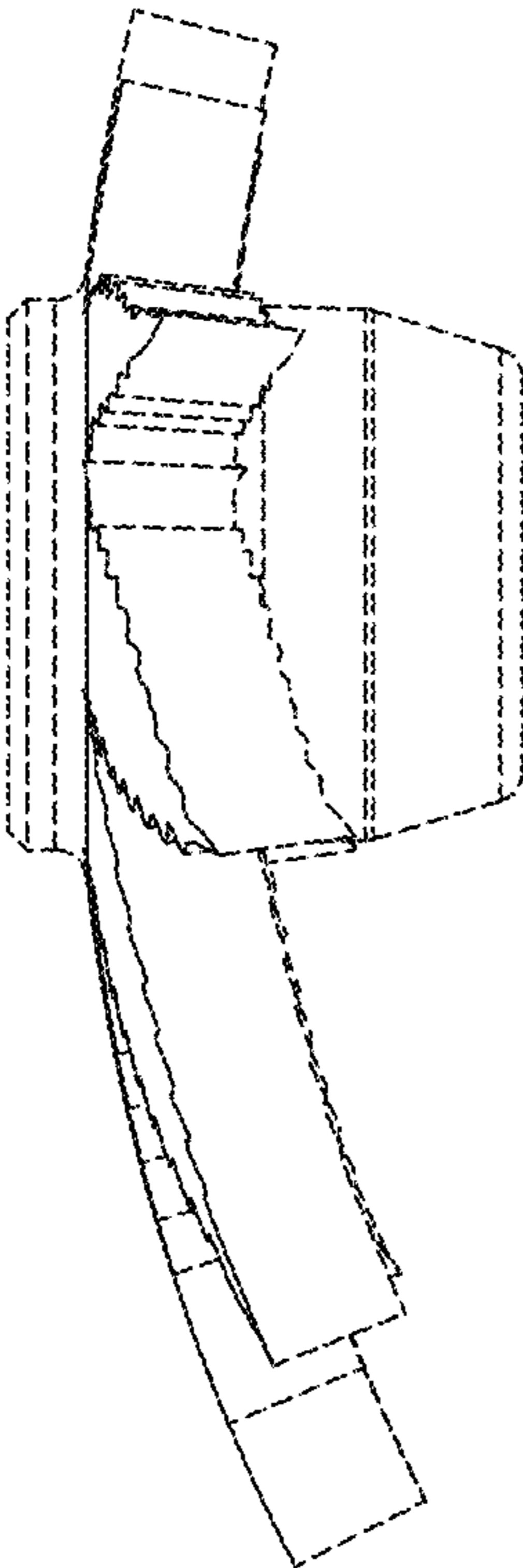

FIG. 2

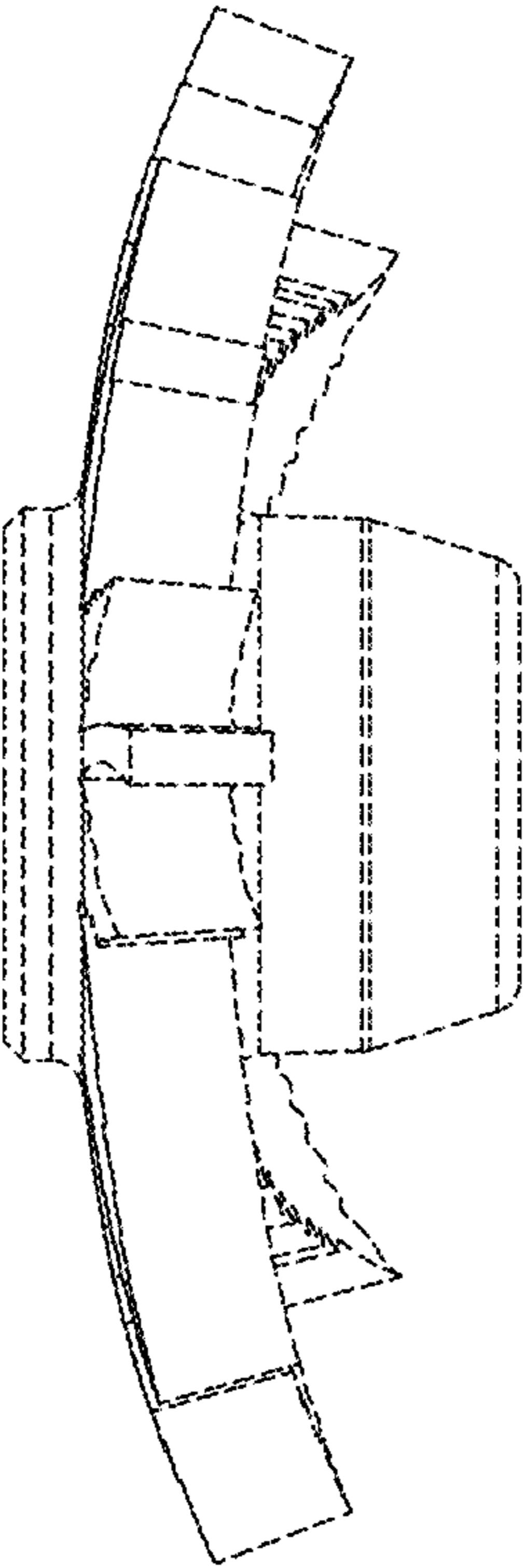

FIG. 3

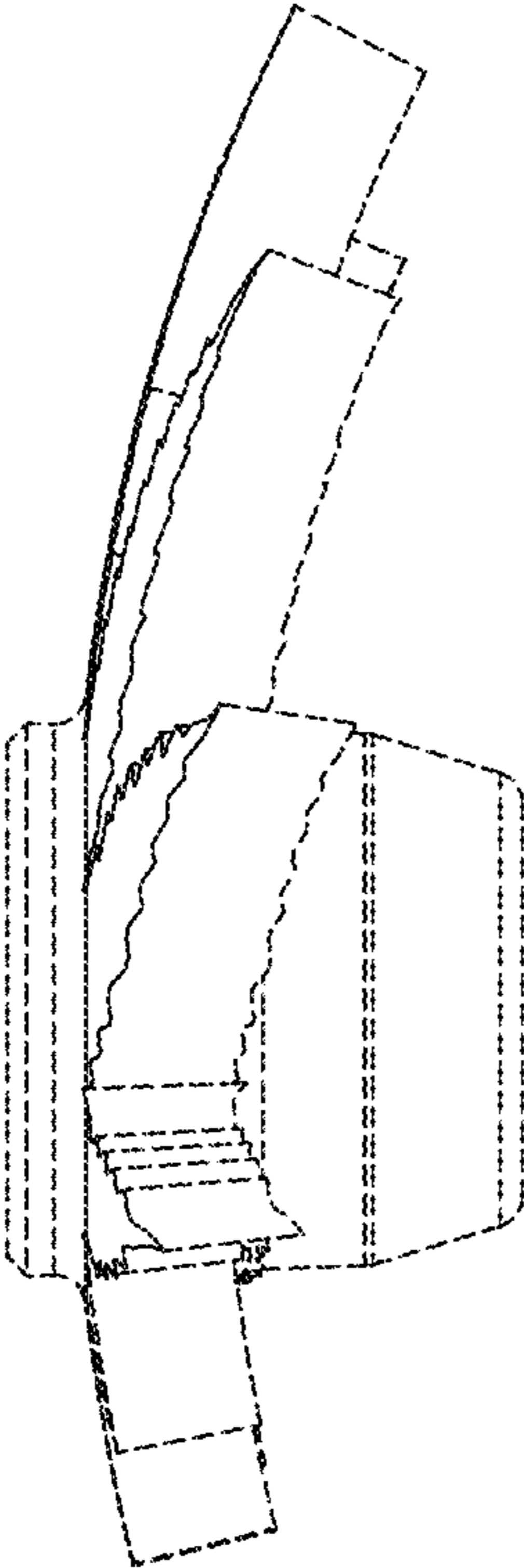

FIG. 4

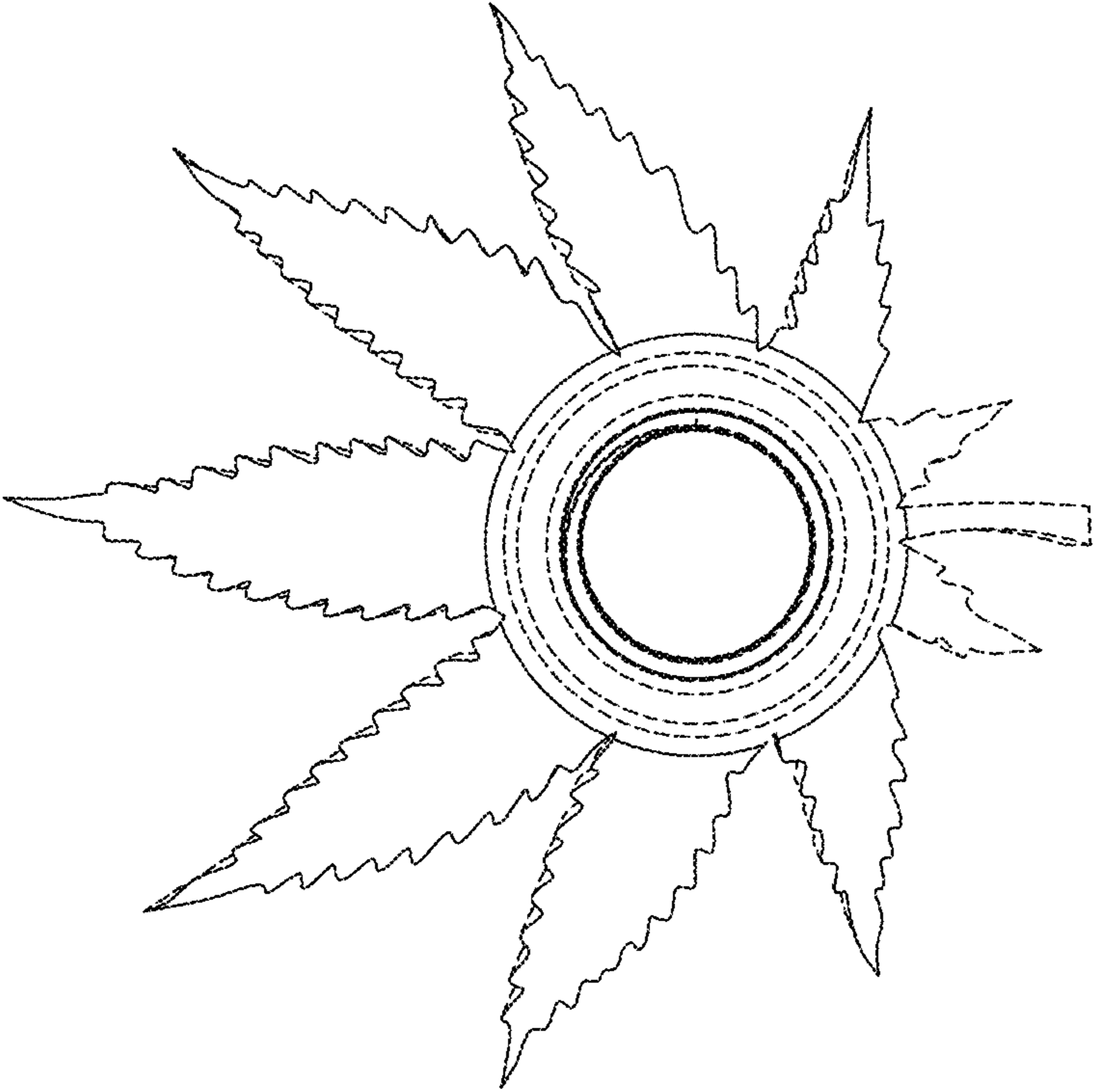
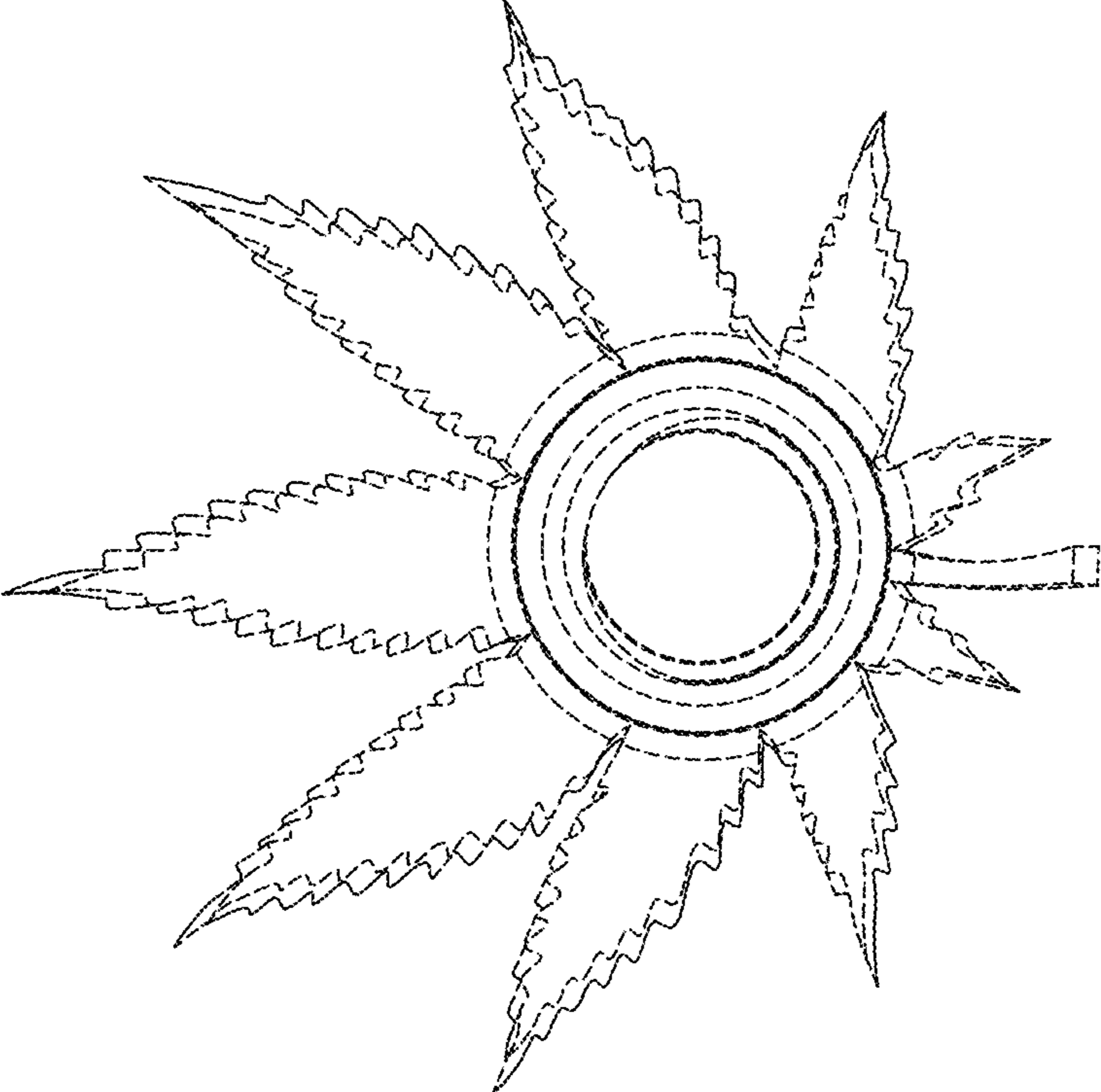

FIG. 5

FIG. 6



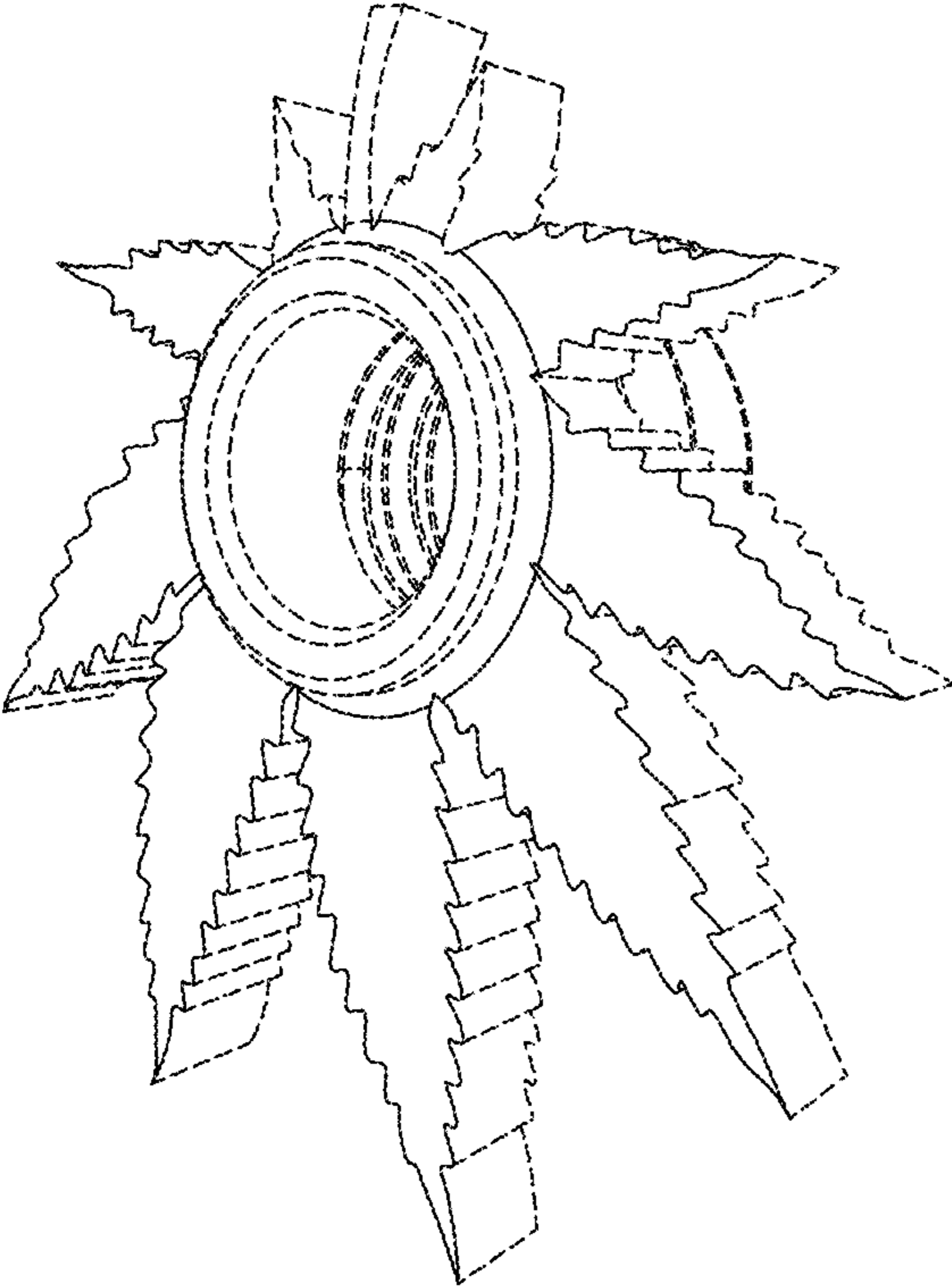

FIG. 7

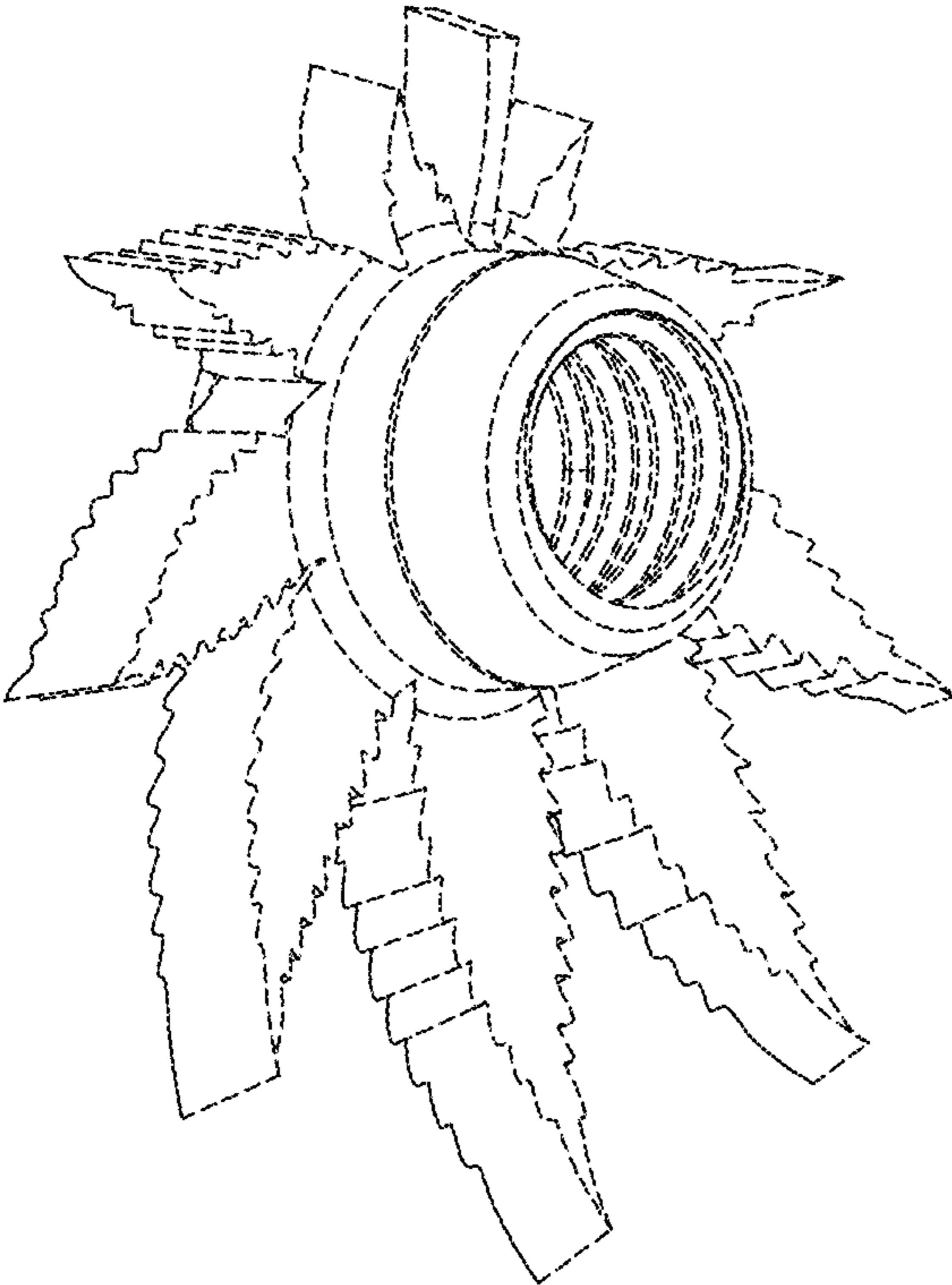

FIG. 8

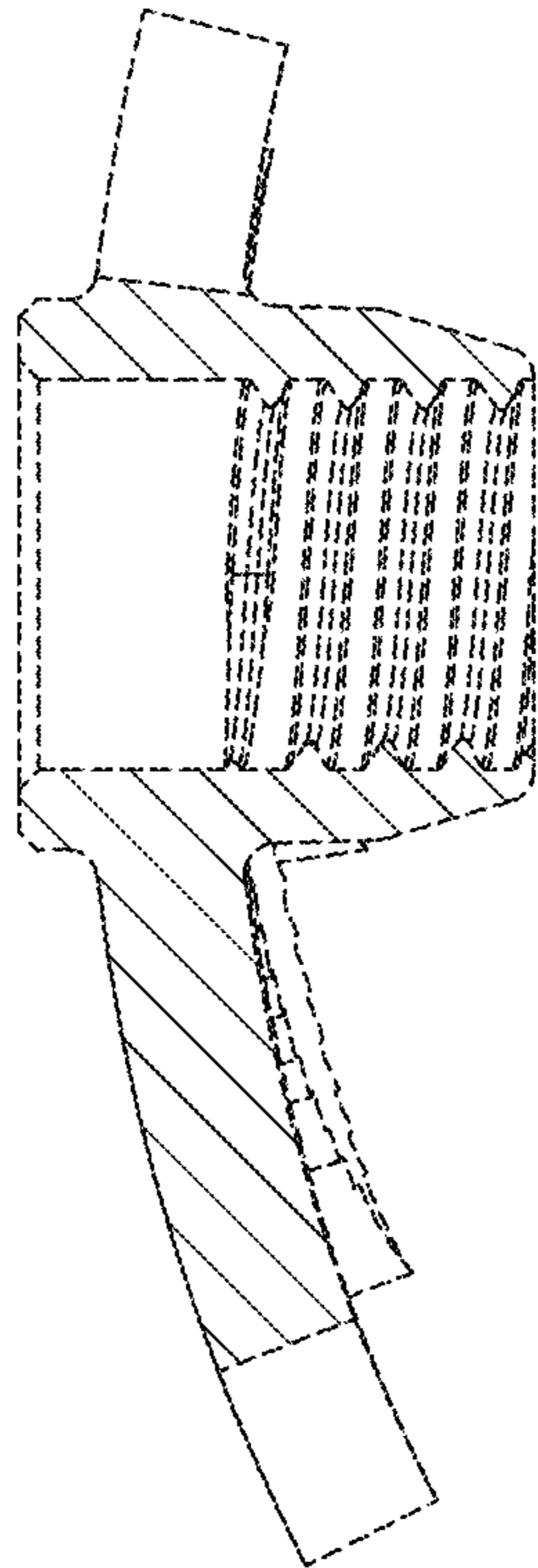

FIG. 9

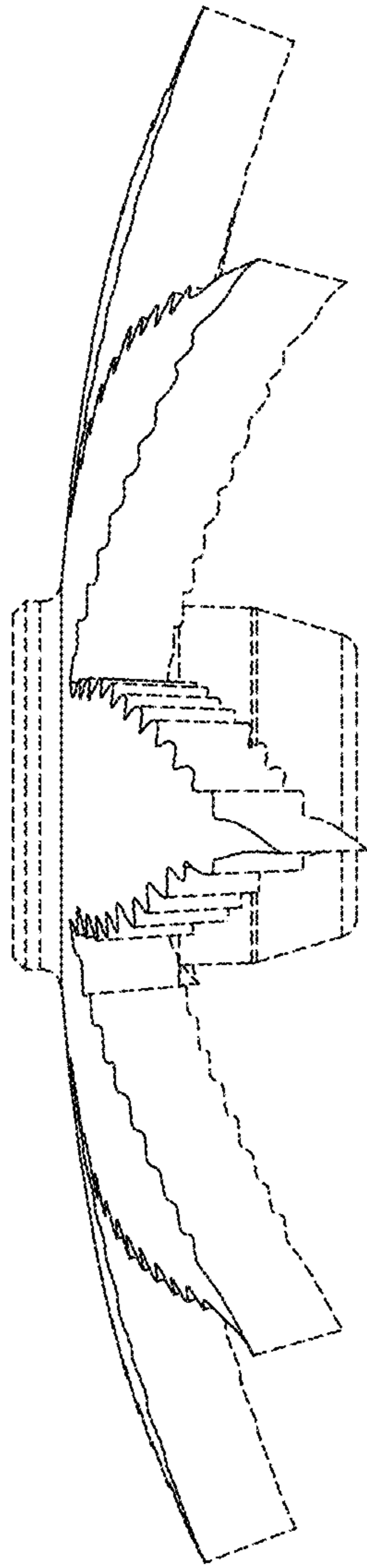

FIG. 10

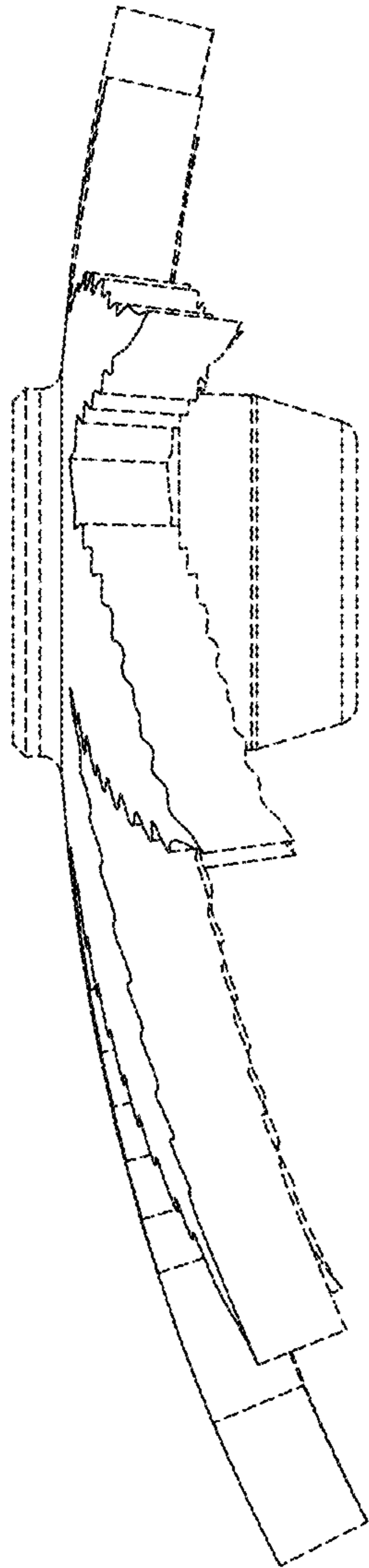

FIG. 11

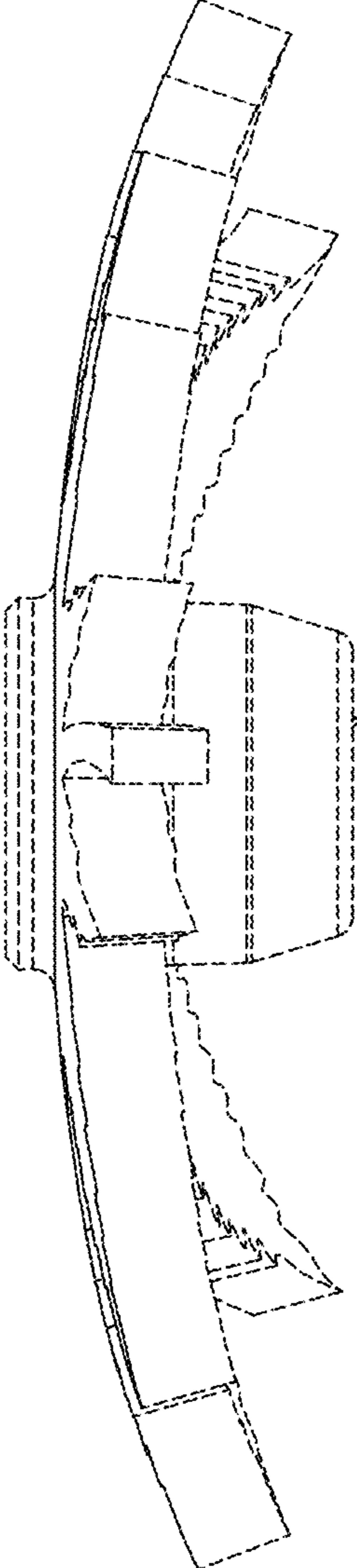

FIG. 12

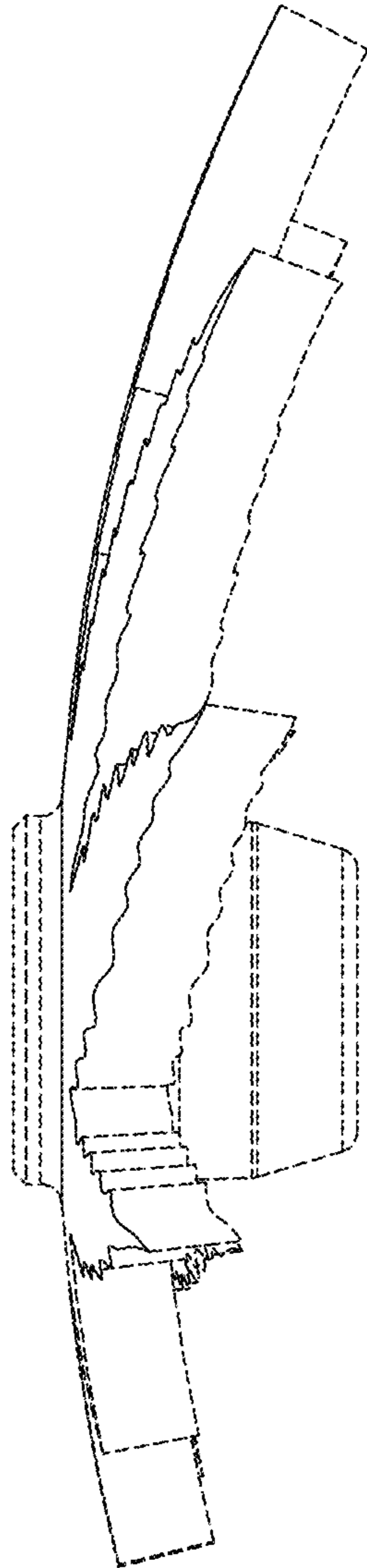

FIG. 13

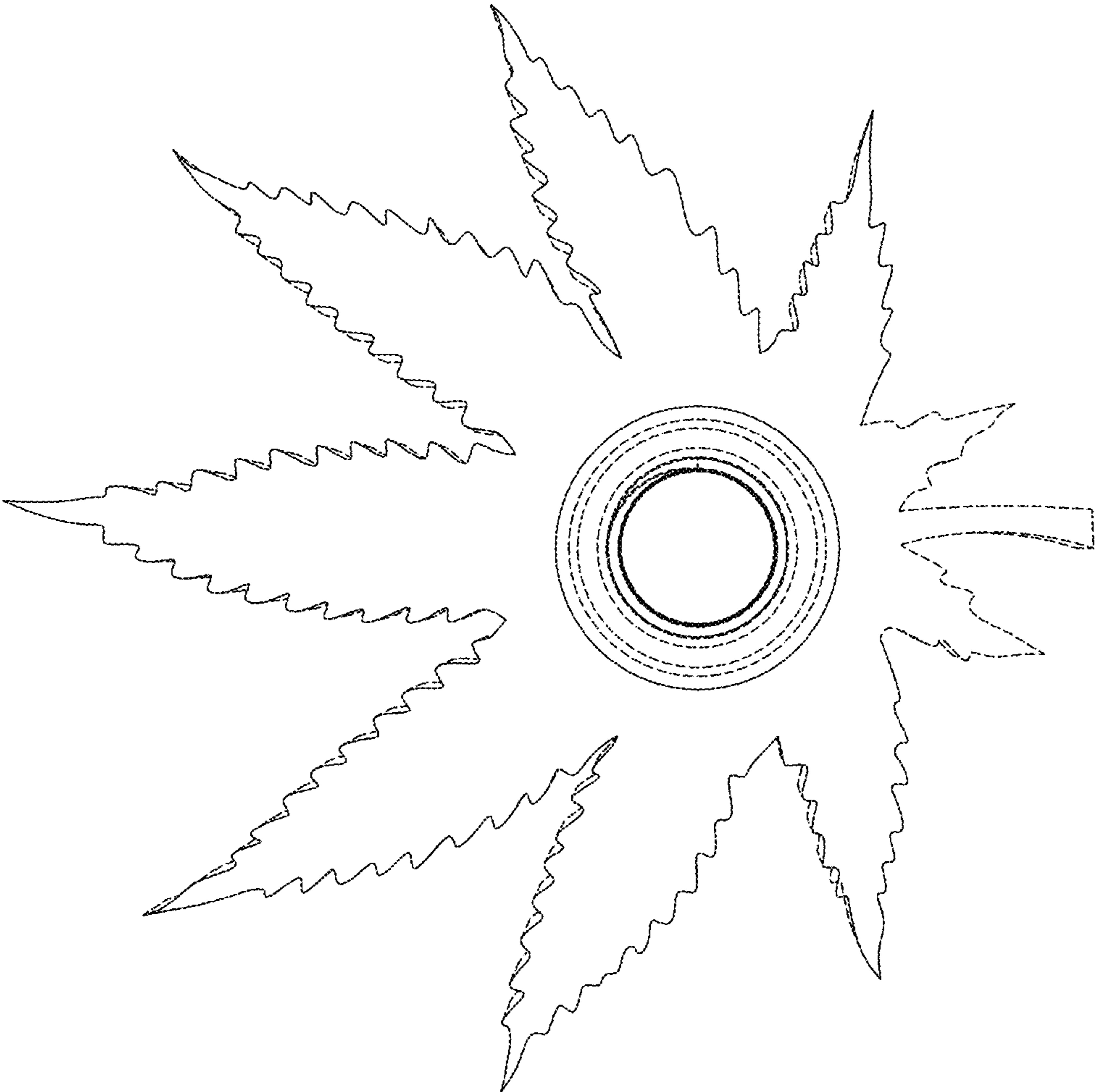

FIG. 14

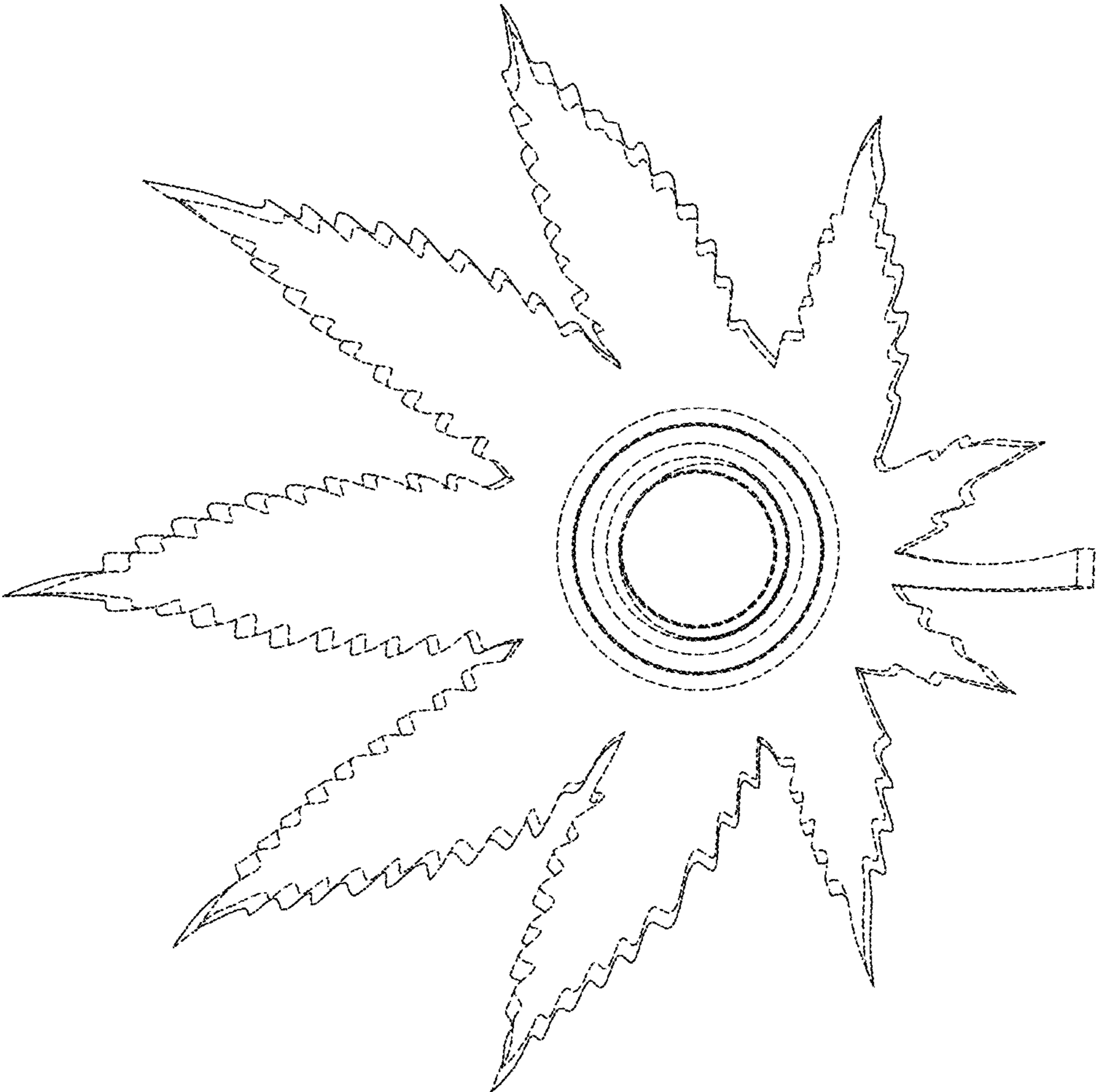

FIG. 15

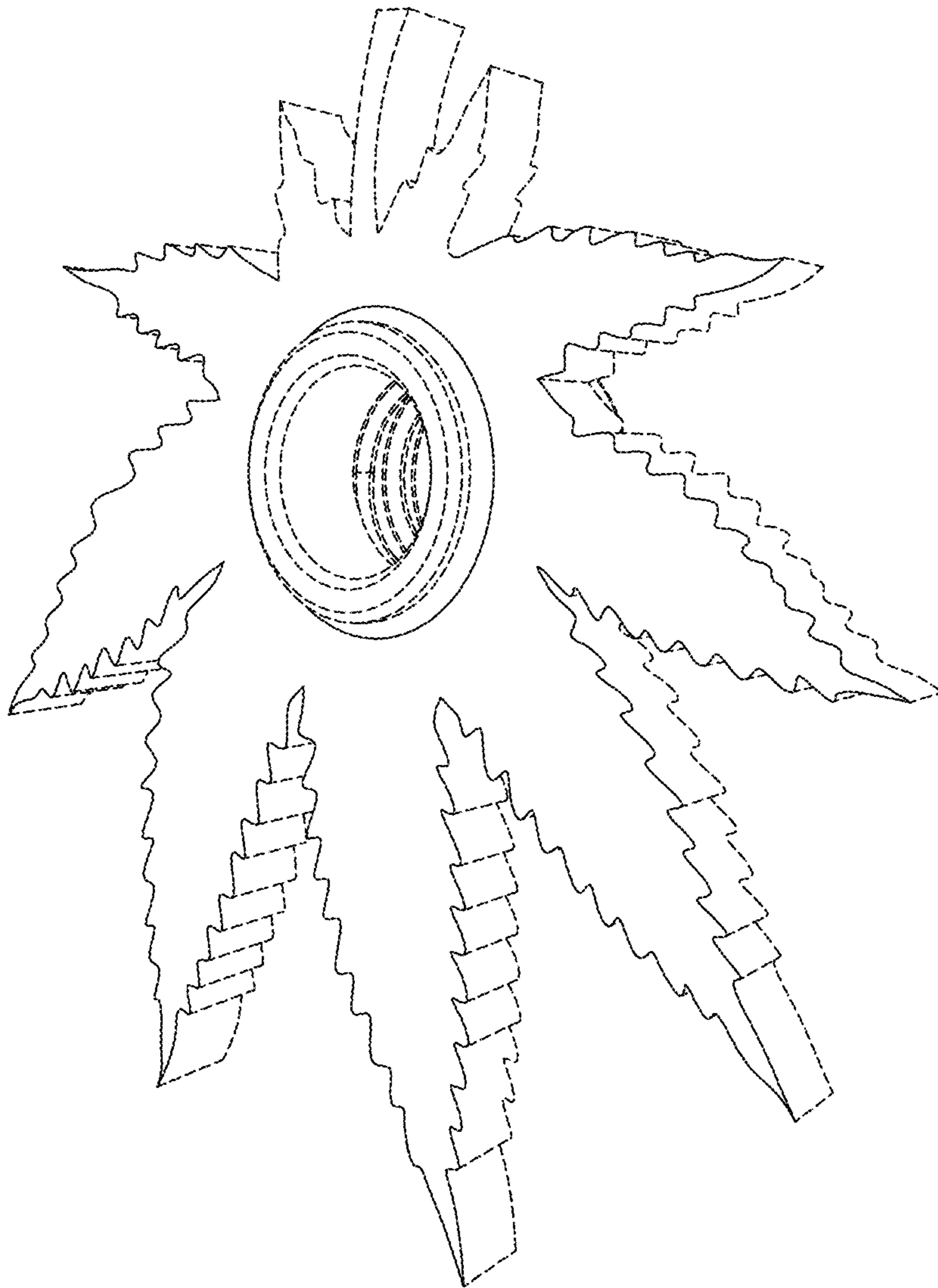

FIG. 16

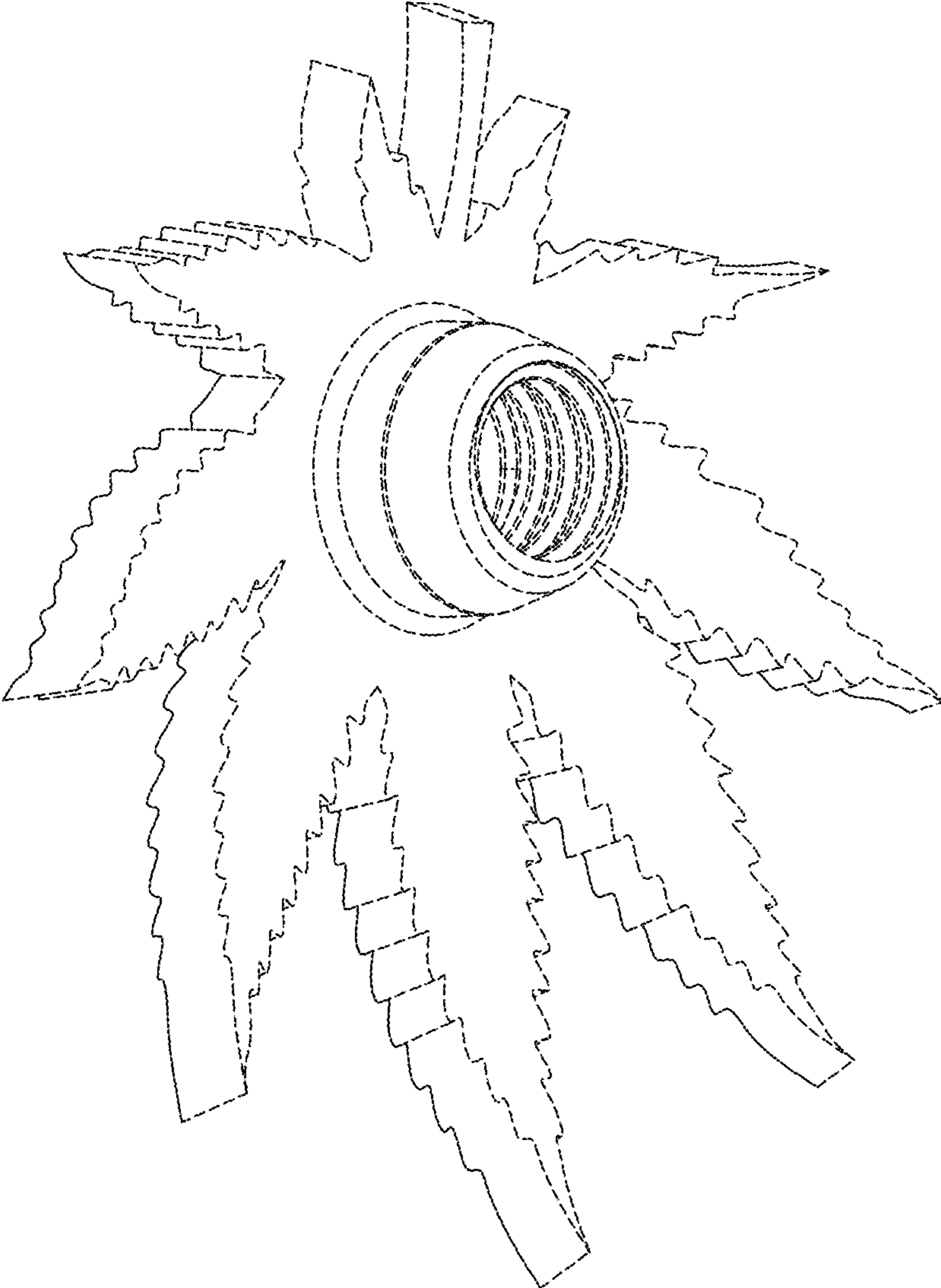

FIG. 17

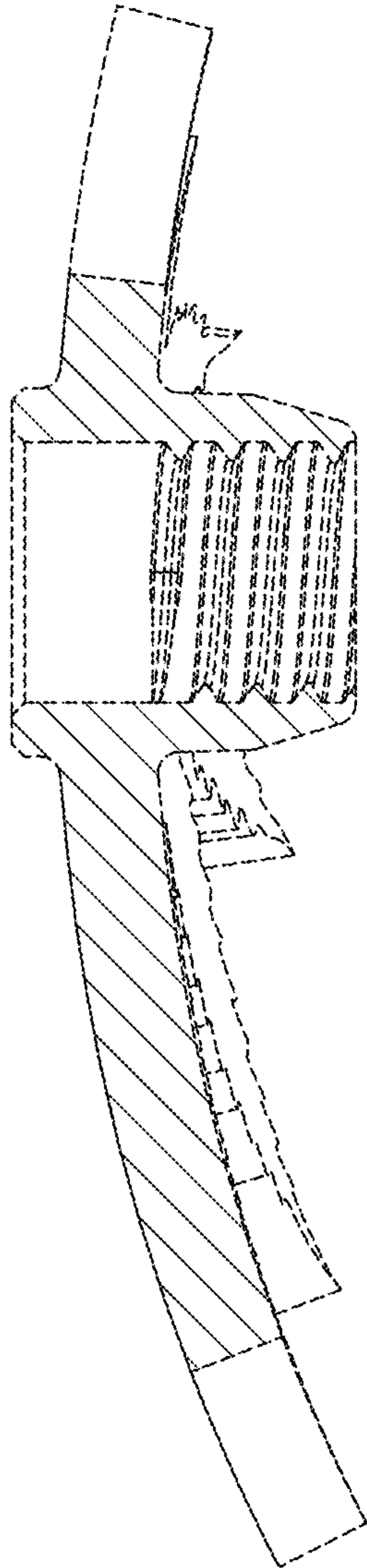

FIG. 18

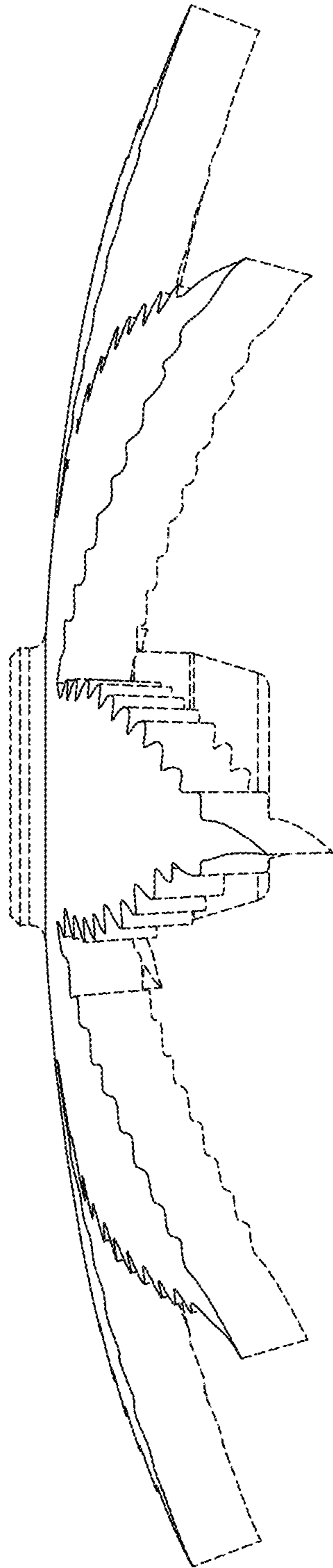

FIG. 19

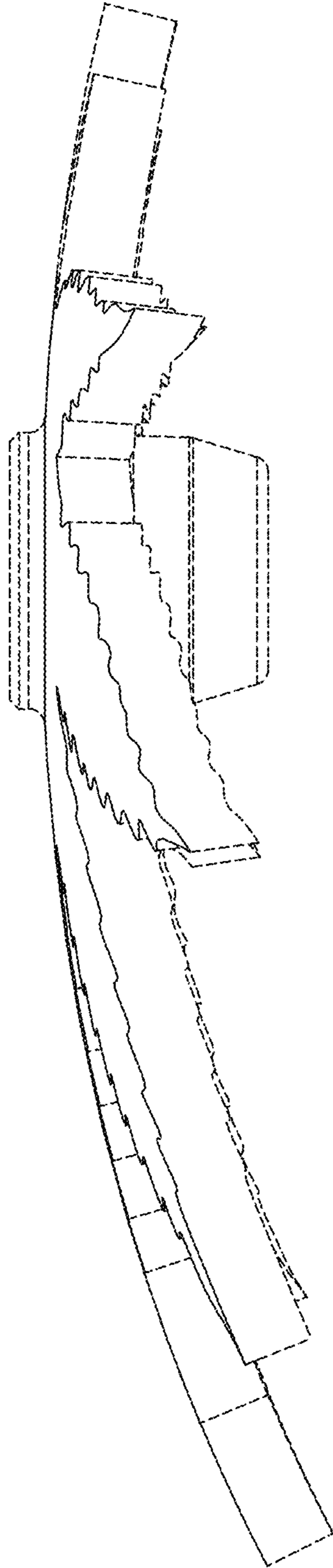

FIG. 20

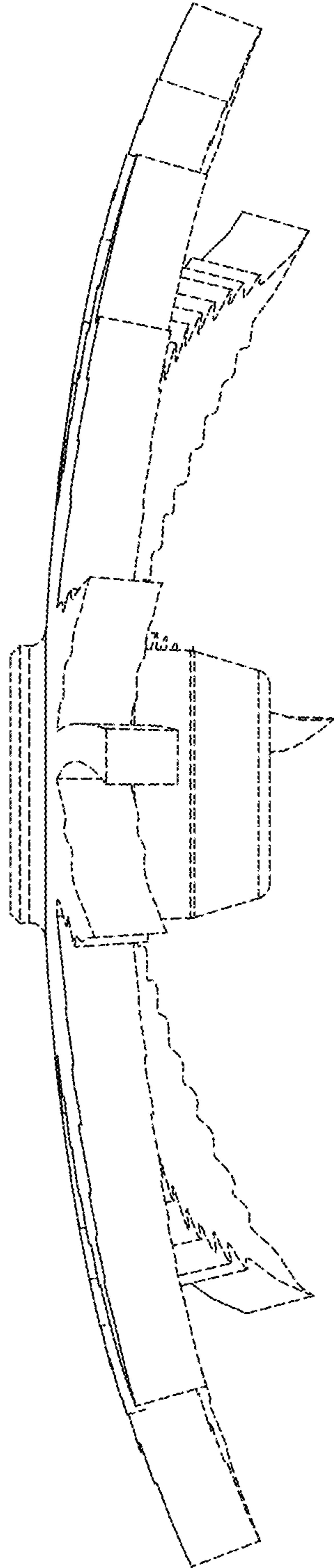

FIG. 21

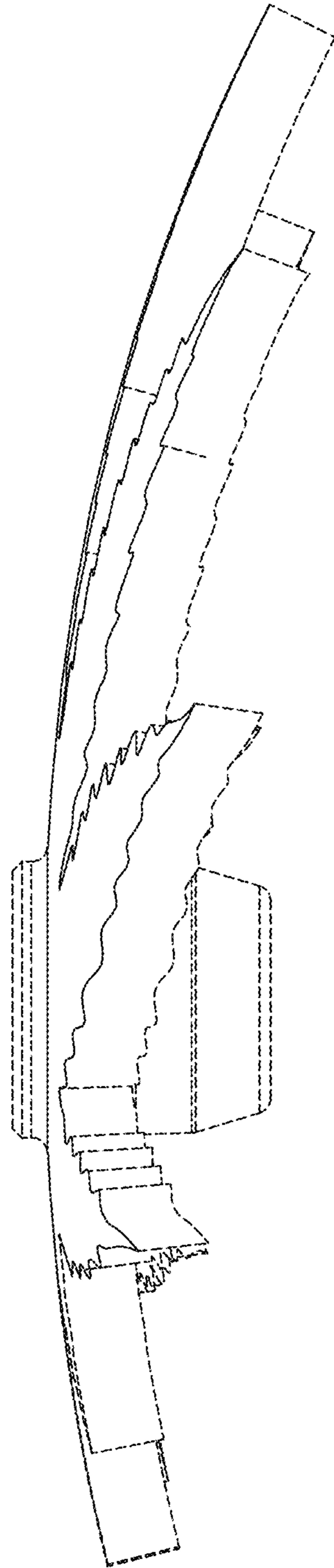

FIG. 22

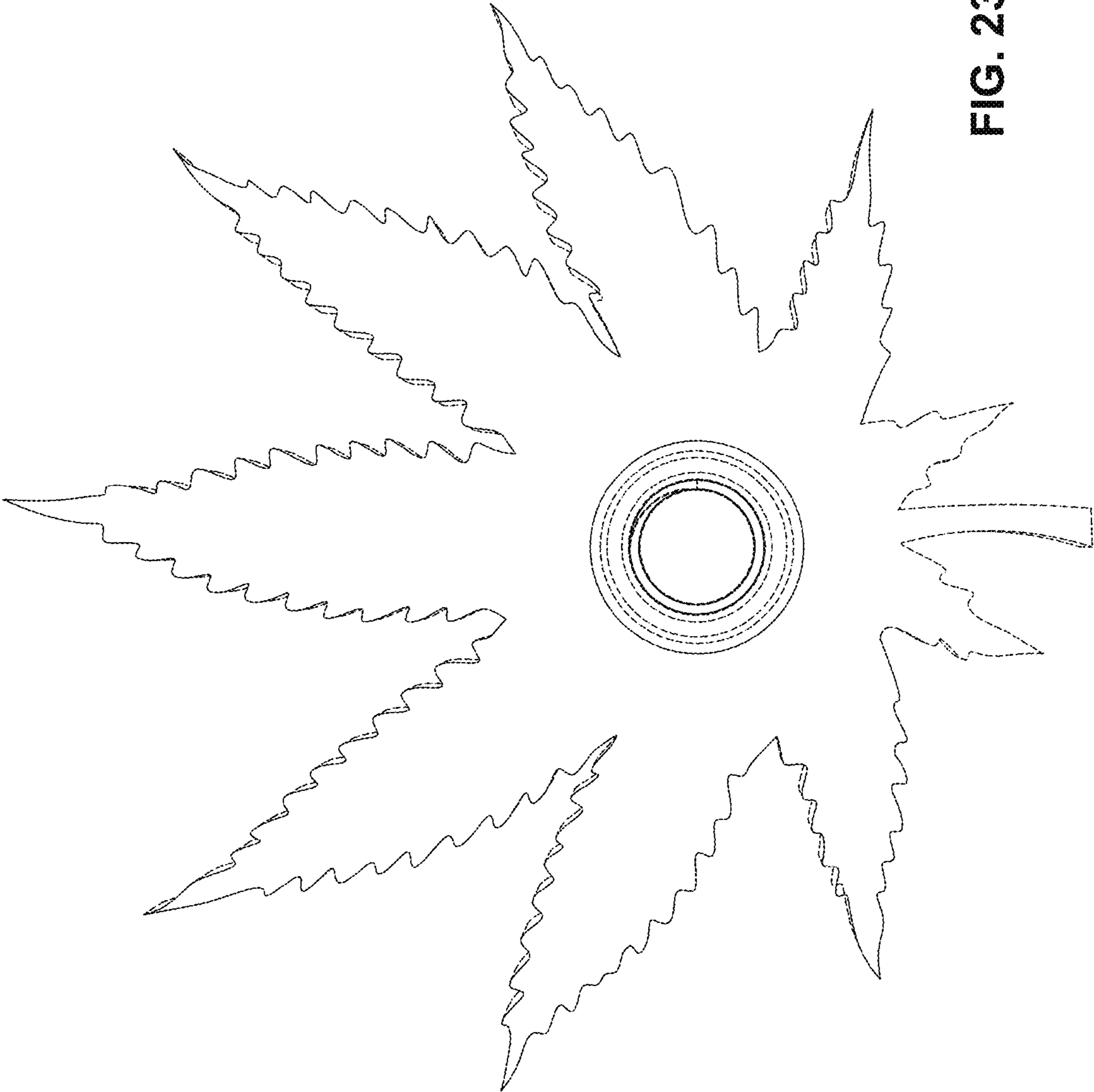

FIG. 23

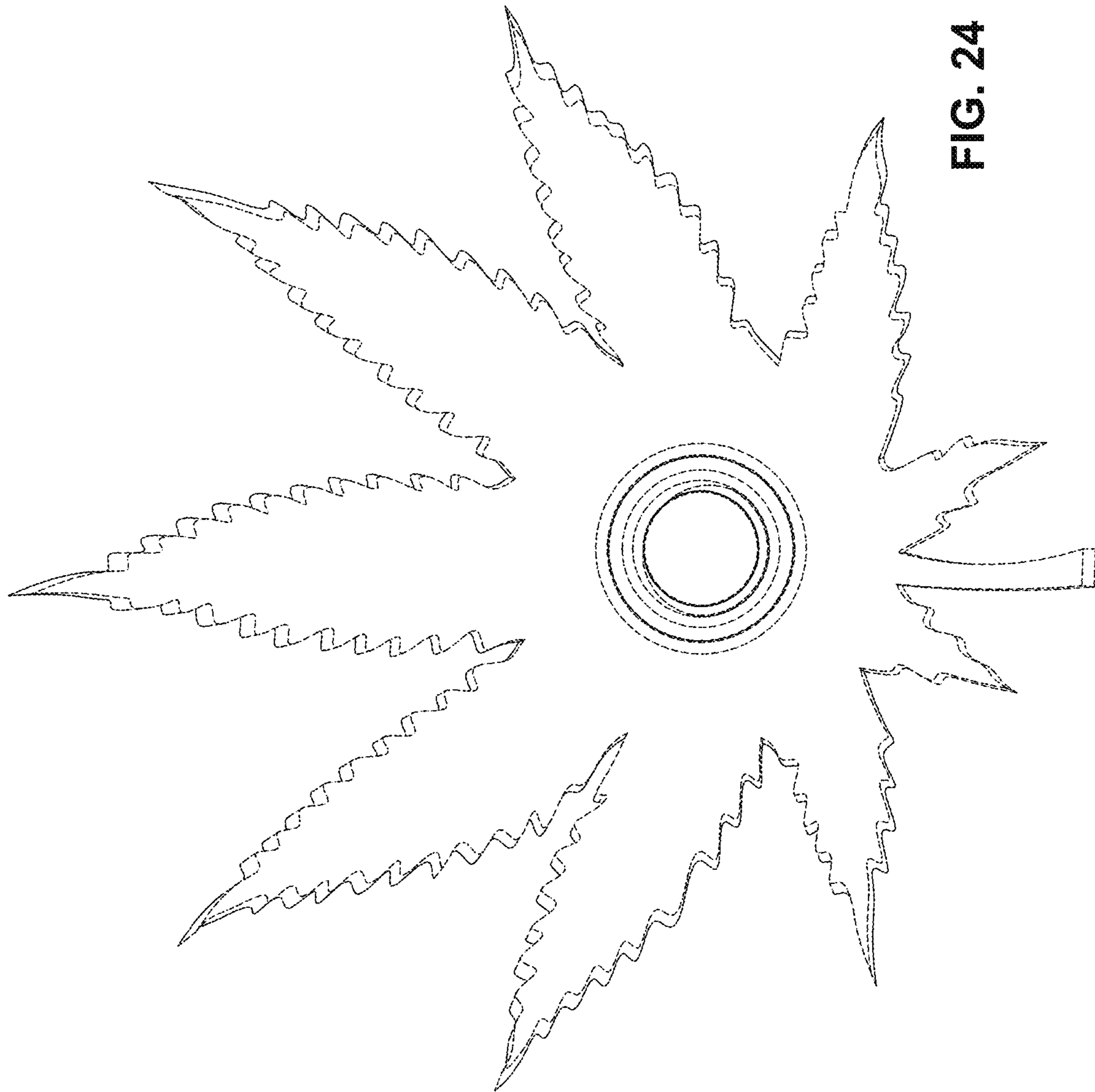

FIG. 24

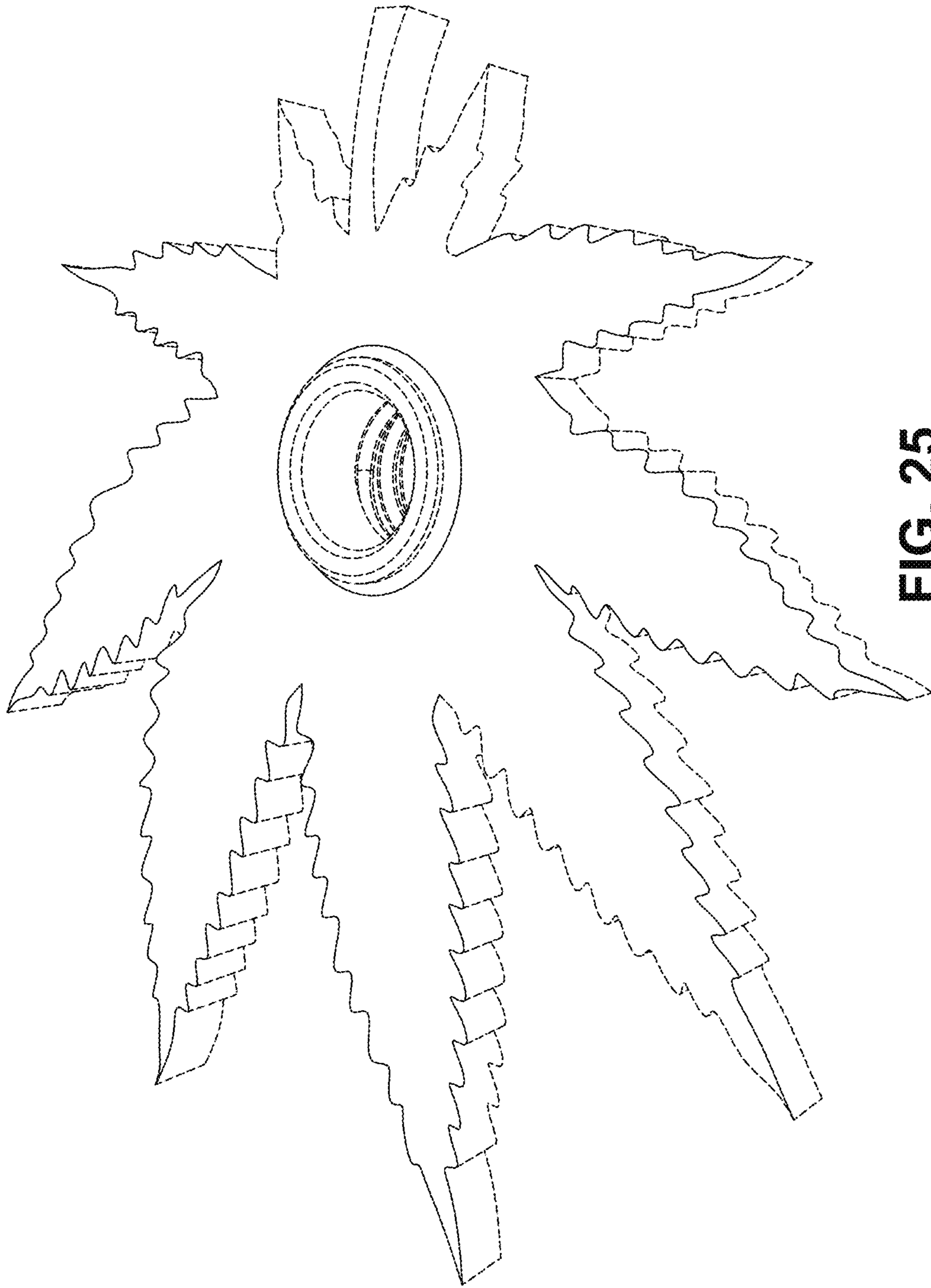

FIG. 25

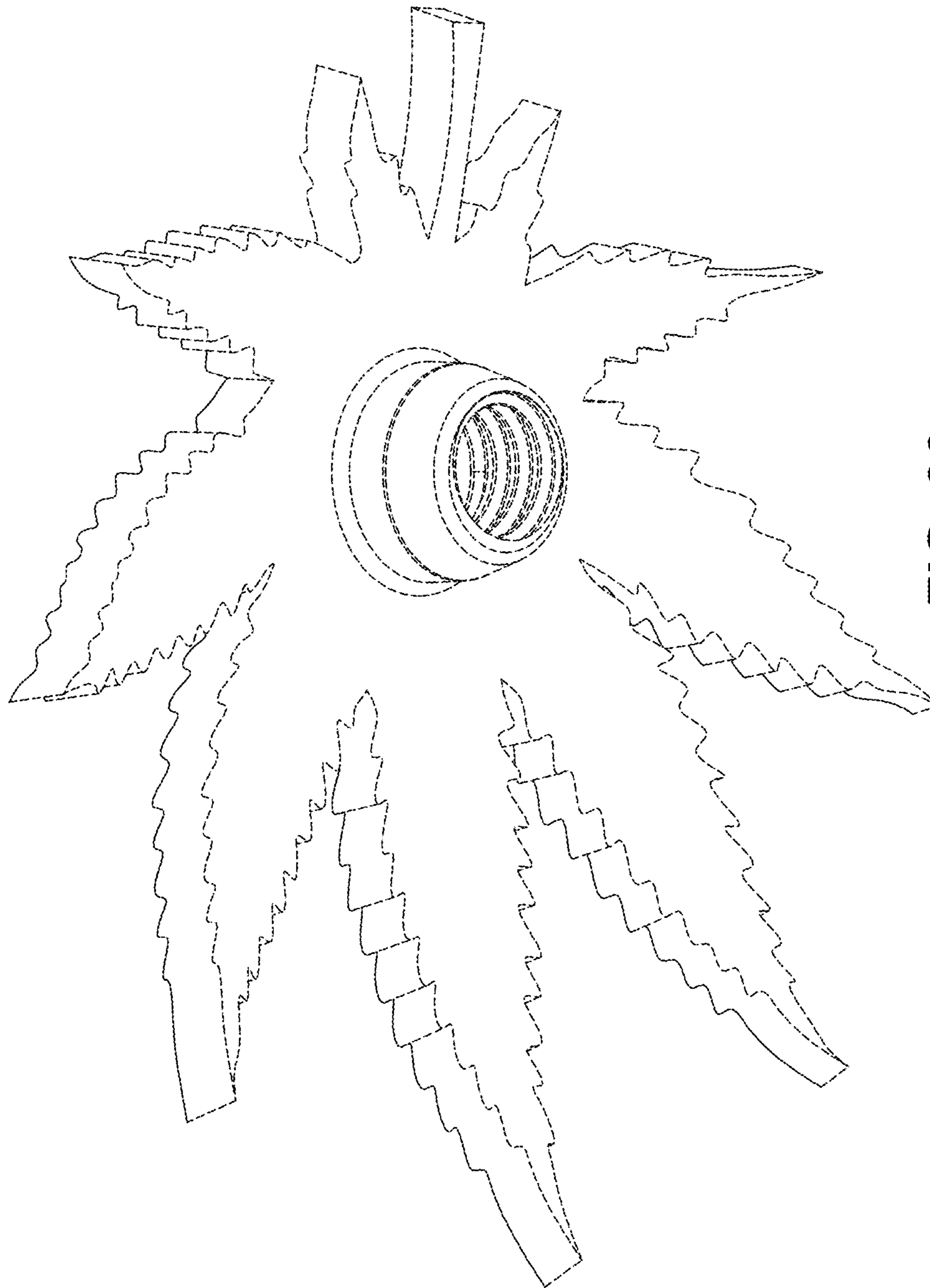

FIG. 26

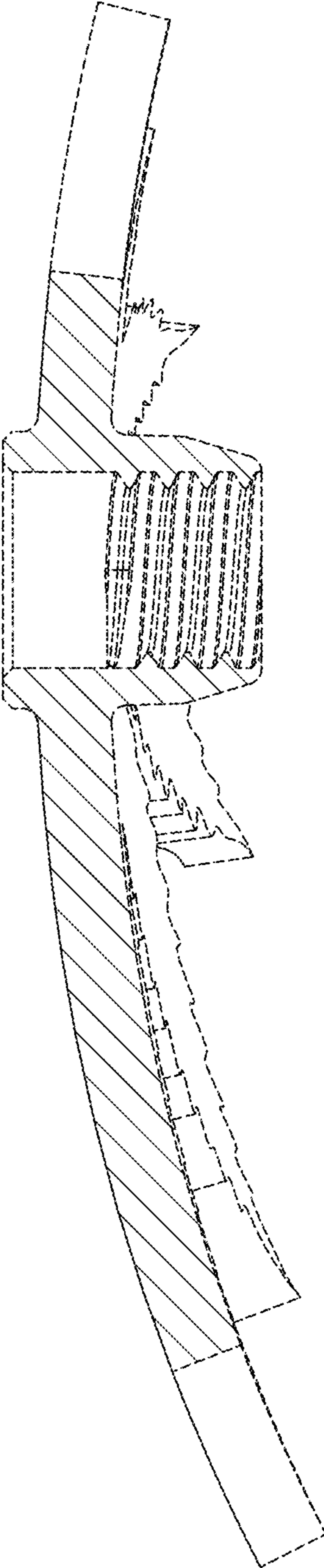

FIG. 27