



US00D774484S

(12) **United States Design Patent** (10) **Patent No.:** **US D774,484 S**
Han et al. (45) **Date of Patent:** **** Dec. 20, 2016**

(54) **TV RECEIVER**

(56) **References Cited**

(71) Applicant: **LG ELECTRONICS INC.**, Seoul (KR)

U.S. PATENT DOCUMENTS

(72) Inventors: **Youngsoo Han**, Seoul (KR); **Jongho Kim**, Seoul (KR); **Sunha Park**, Seoul (KR); **Youngkyoung Kim**, Seoul (KR); **Nari Lee**, Seoul (KR)

D529,005 S *	9/2006	Hong	D14/126
D535,630 S *	1/2007	Yokota	D14/126
D539,245 S *	3/2007	Bischoff	D14/126
D540,760 S *	4/2007	Macey	D14/126
D597,976 S *	8/2009	Gredler	D14/126
D599,791 S *	9/2009	Kuang	D14/314
D680,980 S *	4/2013	Park	D14/126
D715,756 S *	10/2014	Lim	D14/126
D722,300 S *	2/2015	Won	D14/126
D743,922 S *	11/2015	Li	D14/126
D744,439 S *	12/2015	Shin	D14/126
D755,785 S *	5/2016	Sirotych	D14/341
D759,619 S *	6/2016	Seo	D14/126

(73) Assignee: **LG ELECTRONICS INC.**, Seoul (KR)

(**) Term: **15 Years**

* cited by examiner

(21) Appl. No.: **29/551,468**

Primary Examiner — Raphael Barkai

(22) Filed: **Jan. 13, 2016**

(74) *Attorney, Agent, or Firm* — Birch, Stewart, Kolasch & Birch, LLP

(30) **Foreign Application Priority Data**

Jul. 14, 2015 (KR) 30-2015-0035388

(51) **LOC (10) Cl.** **14-03**

(57) **CLAIM**

(52) **U.S. Cl.**
USPC **D14/126**

The ornamental design for a TV receiver, as shown and described.

(58) **Field of Classification Search**

DESCRIPTION

USPC D14/125–134, 239, 371, 136, 374–377, D14/440, 450, 448, 336, 342, 159; 312/7.2; 348/836, 838, 180, 184, 325, 348/739; 248/917–924, 465; 345/104, 345/133, 156, 168, 87, 173; D21/329, D21/515, 577, 622, 333, 433, 448, 452, D21/450, 331, 505; D10/15, 26; 446/484, 446/175, 356; D6/477, 479, 300; D20/10, D20/19, 39; D16/203, 241; 160/24
CPC G06F 1/1601; G06F 1/1643; G06F 1/1652; G06F 1/1647; G06F 3/0412; H05K 5/0004; H05K 5/0017; H05K 5/02; H05K 5/0217; H04N 13/0459

FIG. 1 is a front, right side, perspective view of a TV receiver showing our new design;
FIG. 2 is a front view thereof;
FIG. 3 is a rear view thereof;
FIG. 4 is a left side view thereof;
FIG. 5 is a right side view thereof;
FIG. 6 is a top view thereof; and,
FIG. 7 is a bottom view thereof.
The broken lines indicate unclaimed portion of the article that form no part of the claimed design.

See application file for complete search history.

1 Claim, 4 Drawing Sheets

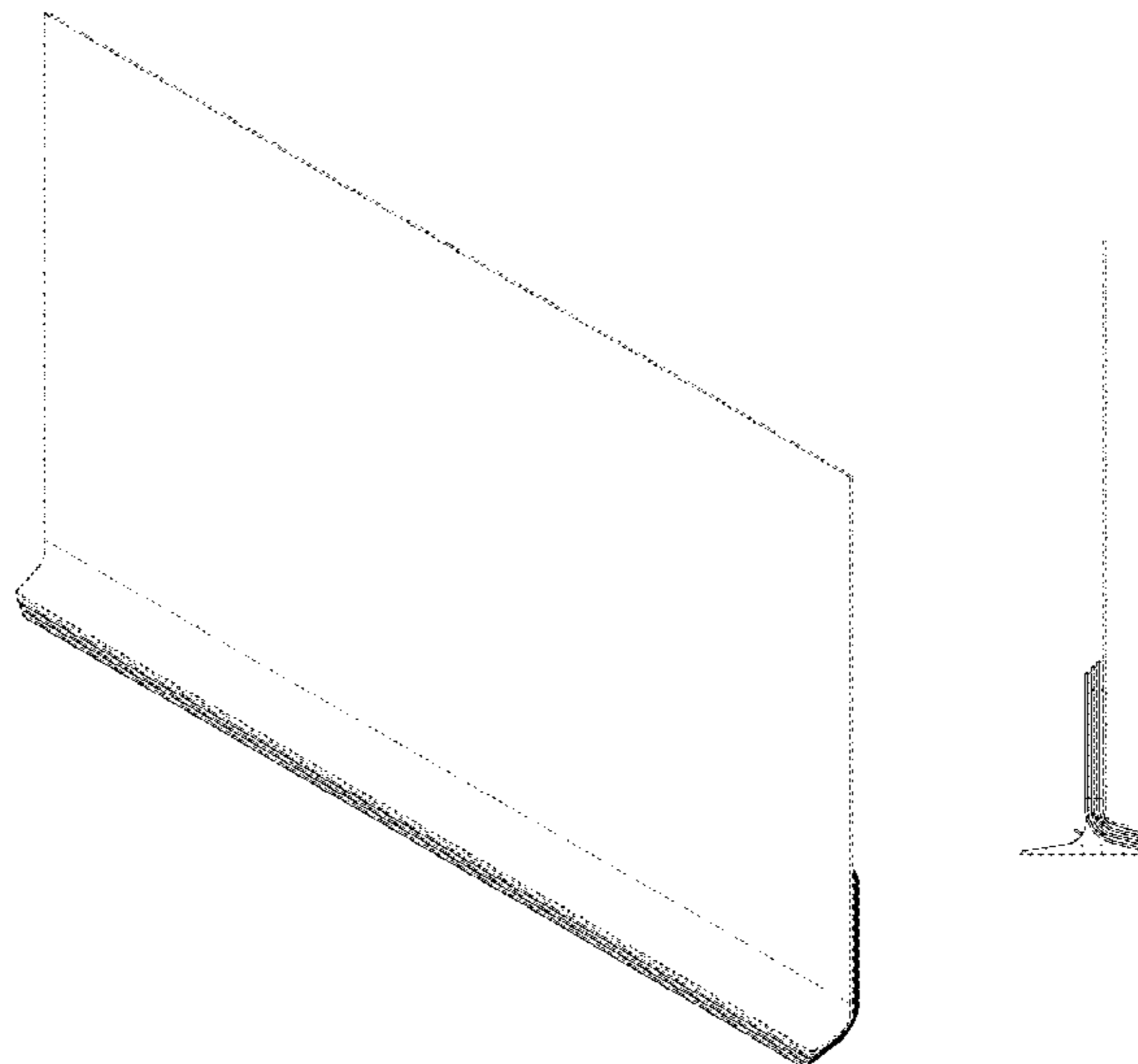

FIG. 1

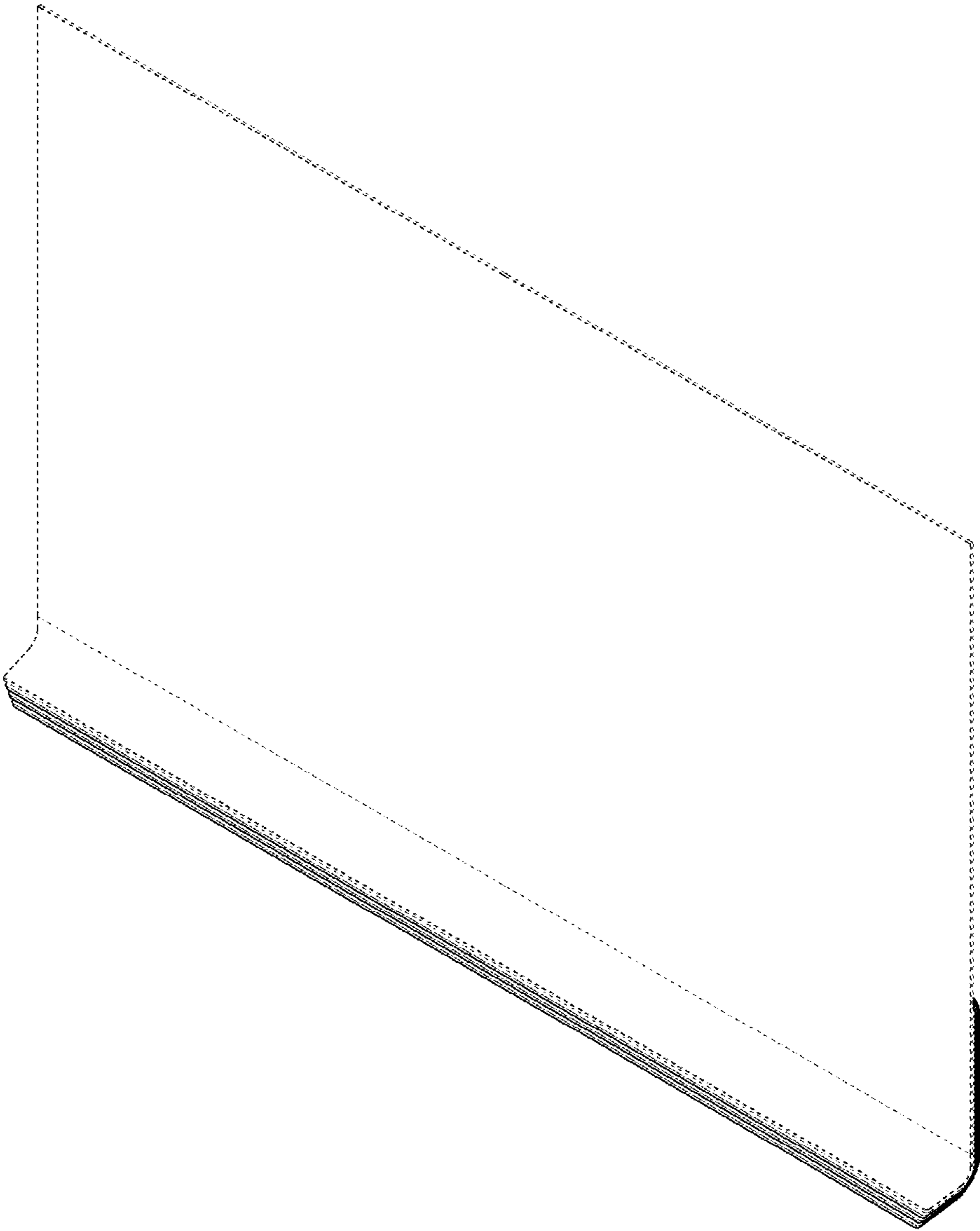

FIG. 2

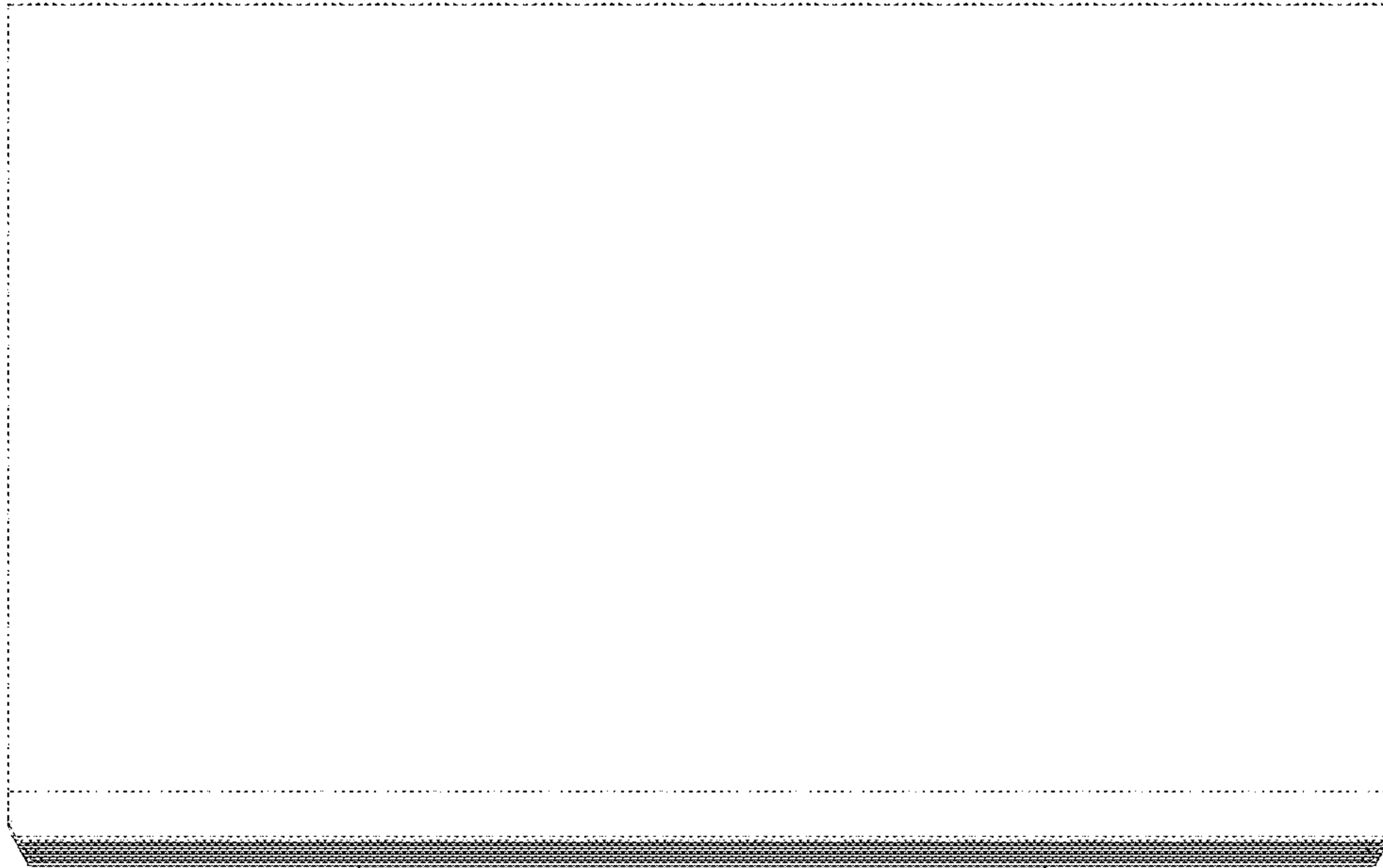

FIG. 3

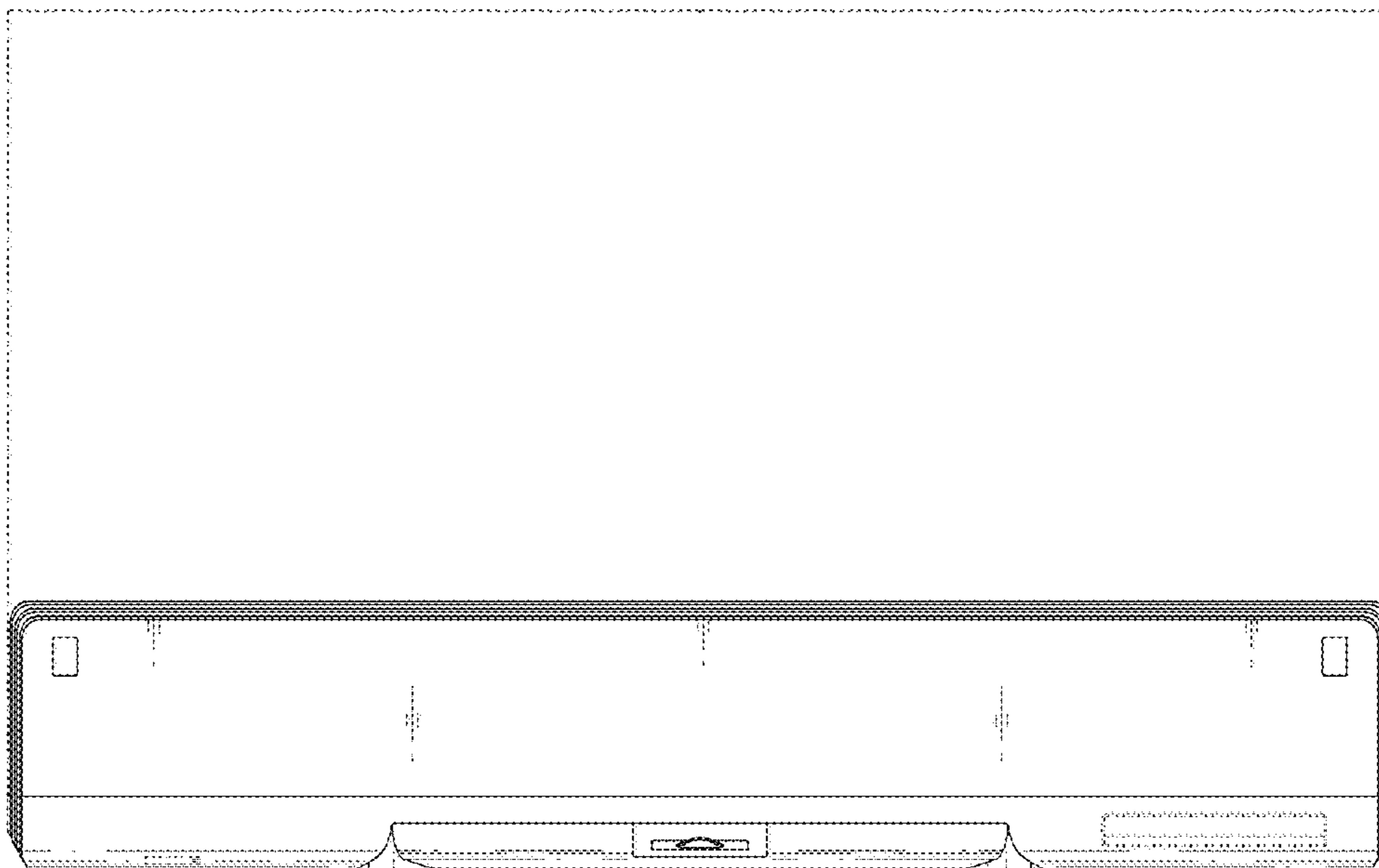

FIG. 4

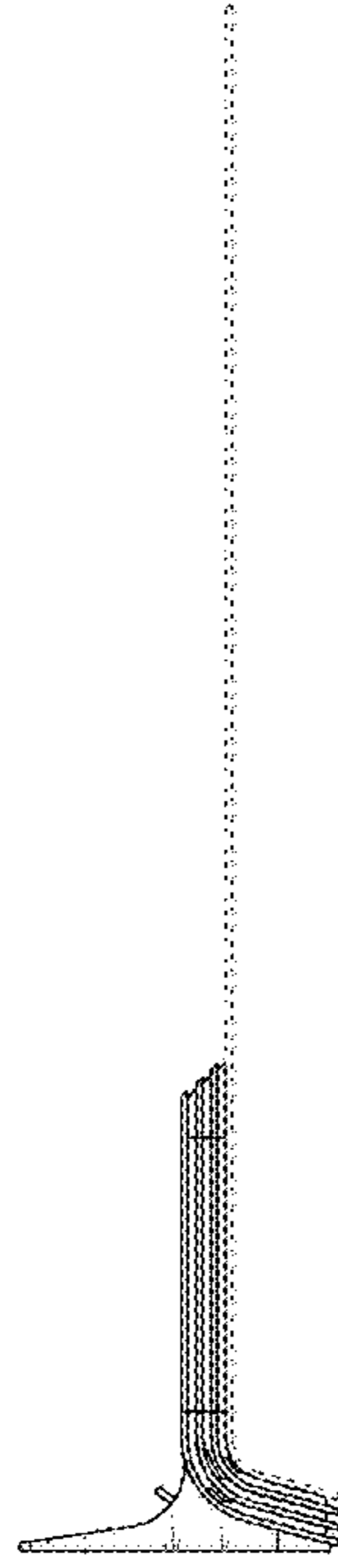

FIG. 5

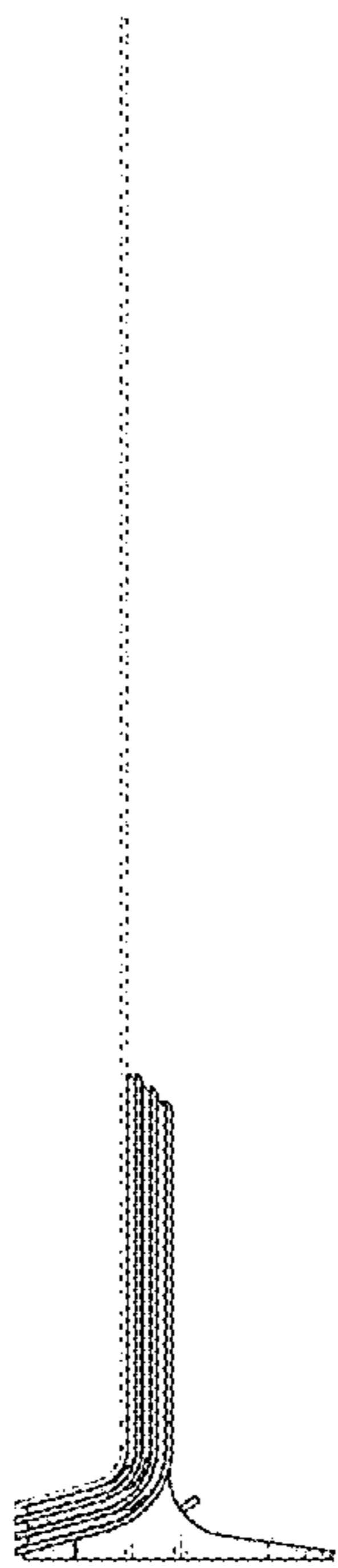

FIG. 6

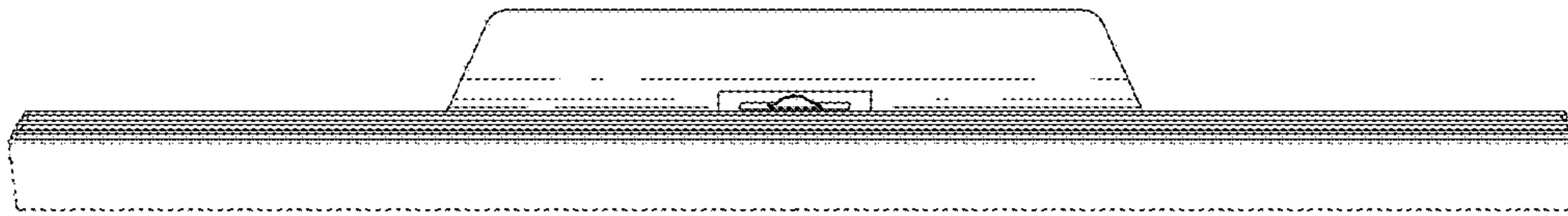

FIG. 7

