



US00D774467S

(12) **United States Design Patent**
Maccarone

(10) **Patent No.:** **US D774,467 S**

(45) **Date of Patent:** **** Dec. 20, 2016**

(54) **DRAFT SEAL FOR AN ELECTRICAL BOX**

(71) Applicant: **Madison Electric Products**, Bedford Heights, OH (US)

(72) Inventor: **Dave Maccarone**, Hudson, OH (US)

(73) Assignee: **MADISON ELECTRIC PRODUCTS**, Bedford Heights, OH (US)

(**) Term: **15 Years**

(21) Appl. No.: **29/540,568**

(22) Filed: **Sep. 25, 2015**

(51) **LOC (10) Cl.** **13-03**

(52) **U.S. Cl.**
USPC **D13/152**

(58) **Field of Classification Search**
USPC D13/152, 133, 137.1, 137.4, 139.3, D13/139.2, 153-156, 184, 199; D8/349, D8/353; 220/3.2, 3.3, 3.4-3.9, 3.92, 3.94; 174/50.52, 50.53, 50.56, 51, 53-60, 66, 174/67, 521; 439/373, 335-337, 541, 675, 439/668, 623, 892, 938
CPC G06F 1/181; H02G 3/08; H02G 3/081; H02G 3/14; H02G 5/08; H05K 5/03; H05K 5/0204
See application file for complete search history.

(56) **References Cited**

U.S. PATENT DOCUMENTS

D711,834 S * 8/2014 Jones D13/152
D766,186 S * 9/2016 Hagarty D13/152
2015/0261345 A1 * 9/2015 Hsu G06F 3/044
345/174

OTHER PUBLICATIONS

Photographs of a Carlon Super Blue Draft Tight Kit previously sold by Lamson & Sessions in 2007; pp. 1-2.

* cited by examiner

Primary Examiner — Wan Laymon

Assistant Examiner — Mark Booker

(74) *Attorney, Agent, or Firm* — Pearne & Gordon LLP

(57) **CLAIM**

The ornamental design for a draft seal for an electrical box, as shown and described.

DESCRIPTION

FIG. 1 is a front perspective view of a first draft seal showing my new design of which the color green forms part of the design;

FIG. 2 is a rear perspective view thereof;

FIG. 3 is a left side view thereof;

FIG. 4 is a right side view thereof;

FIG. 5 is a top view thereof;

FIG. 6 is a bottom view thereof;

FIG. 7 is a front view thereof;

FIG. 8 is a rear view thereof;

FIG. 9 is a front perspective view of a second draft seal showing my new design of which the color green forms part of the design;

FIG. 10 is a rear perspective view thereof;

FIG. 11 is a left side view thereof;

FIG. 12 is a right side view thereof;

FIG. 13 is a top view thereof;

FIG. 14 is a bottom view thereof;

FIG. 15 is a front view thereof; and,

FIG. 16 is a rear view thereof.

This patent contains a least one drawing in which elements of the design include color. Elements embodied with color are represented by black and white cross-hatching for the color green. The stippling utilized in the drawings indicates a contrasting appearance that contrasts with the color green, and does not depict any particular color, texture, or material.

1 Claim, 12 Drawing Sheets

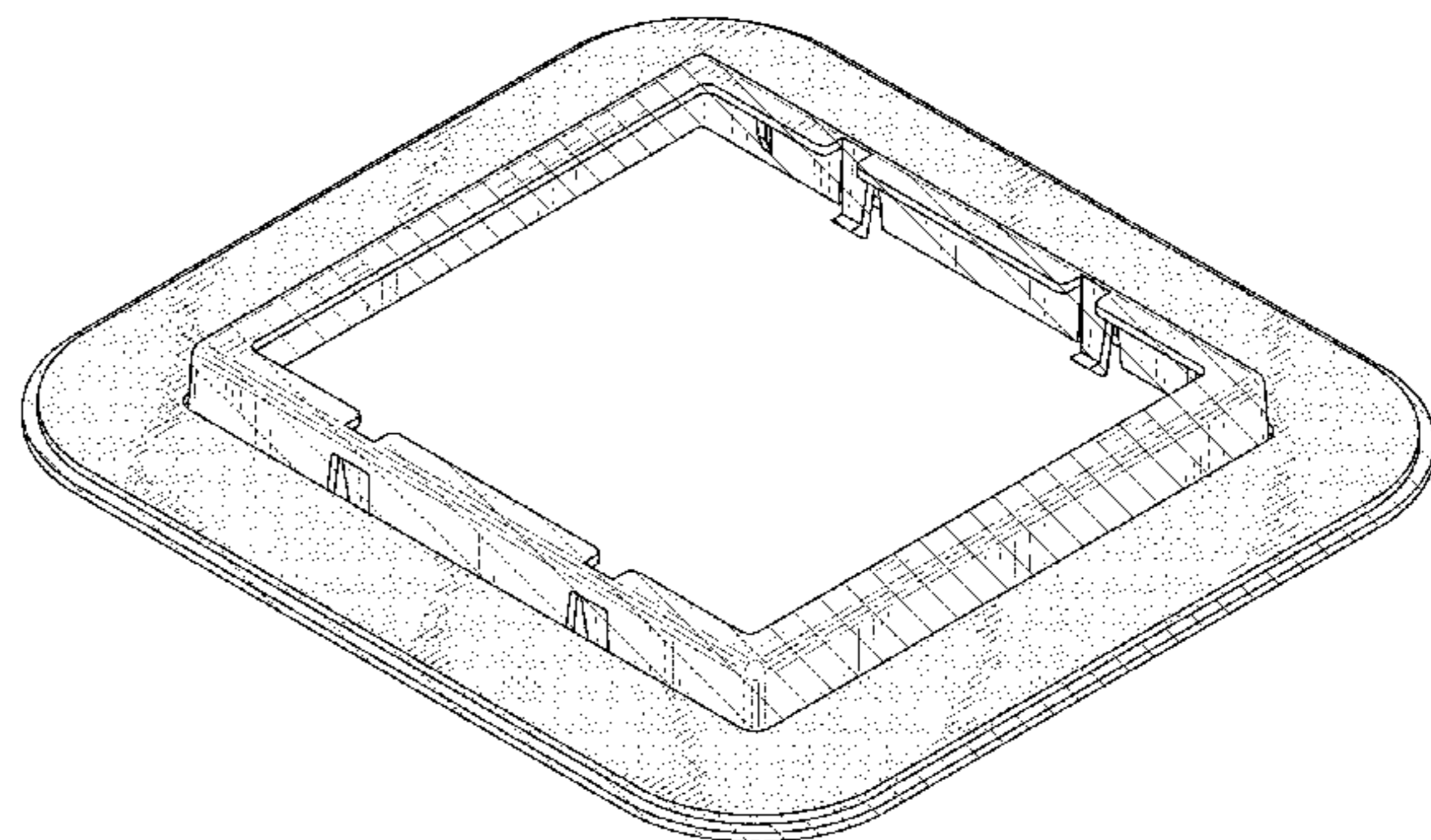
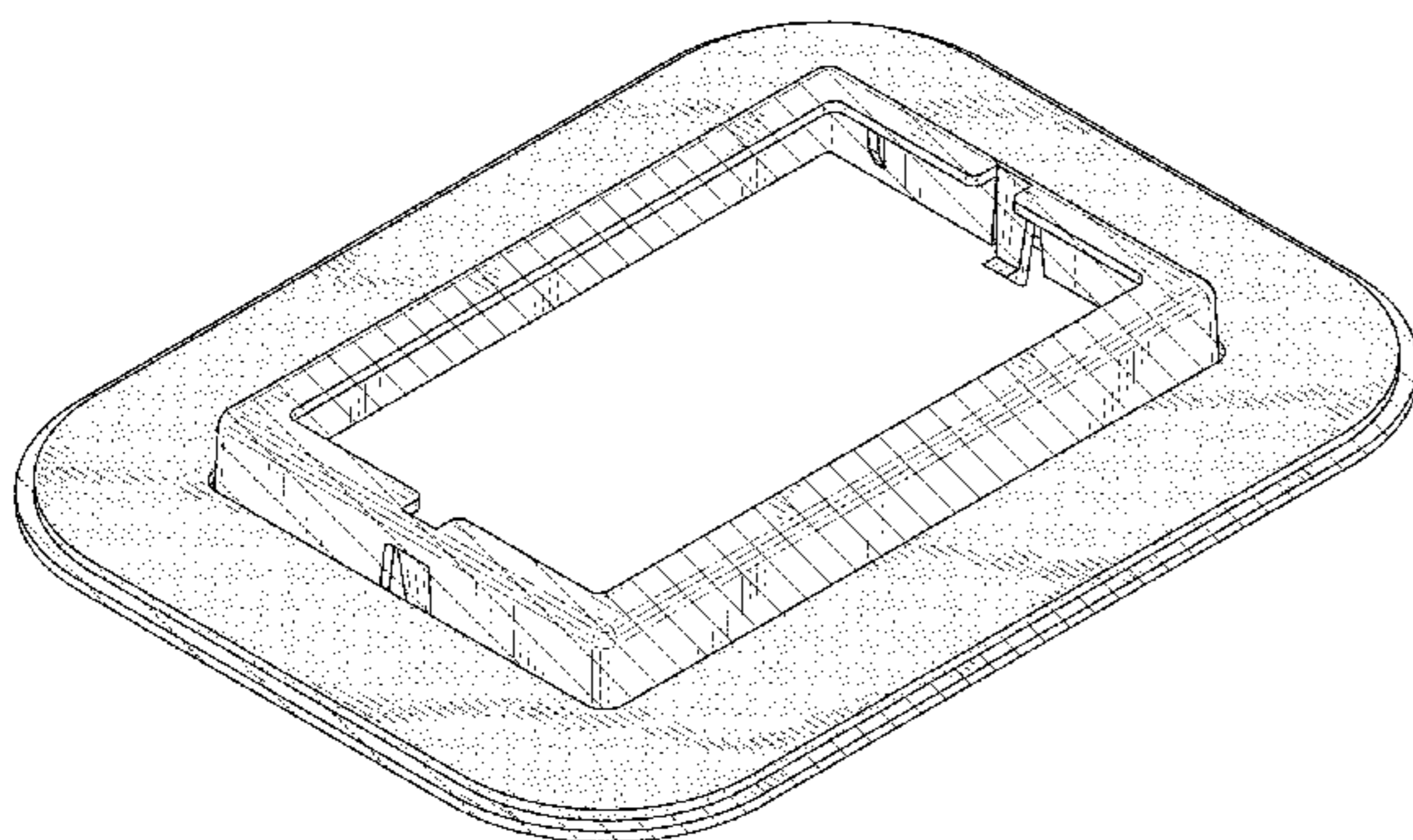

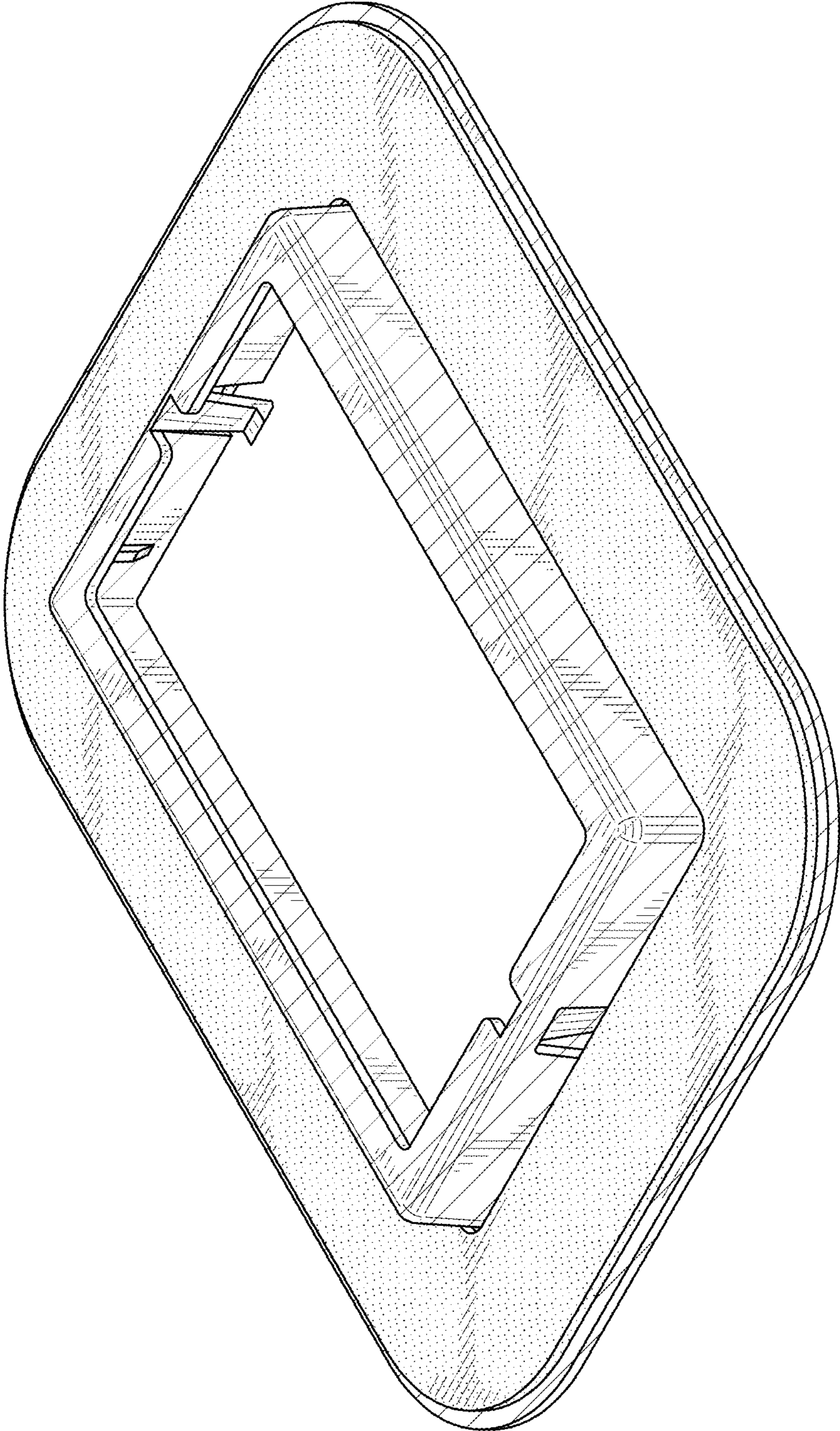

FIG. 1

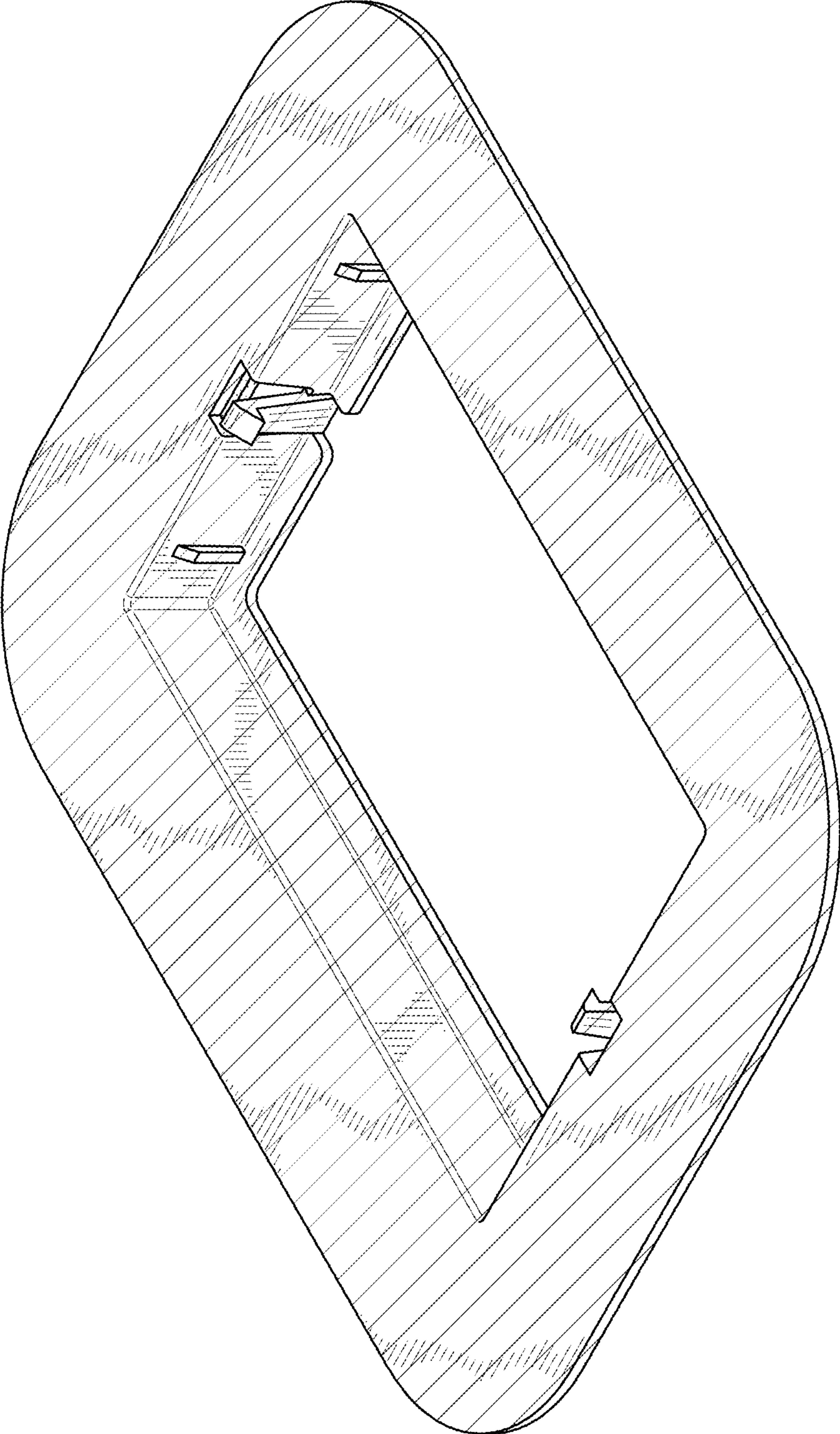

FIG. 2

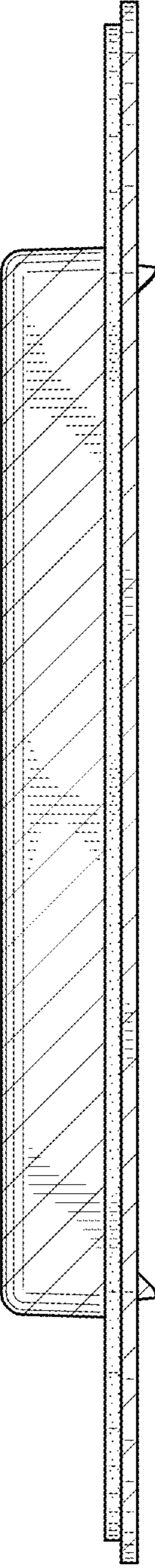

FIG. 3

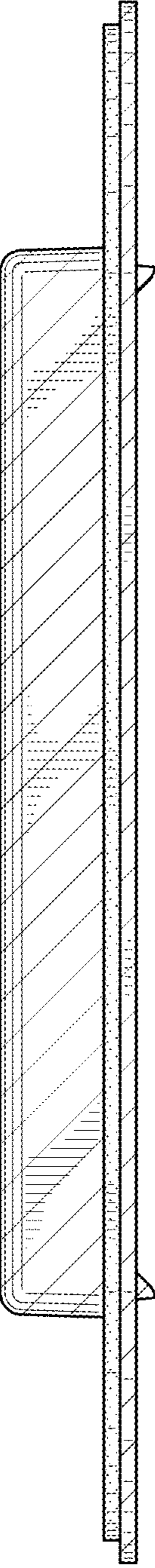

FIG. 4

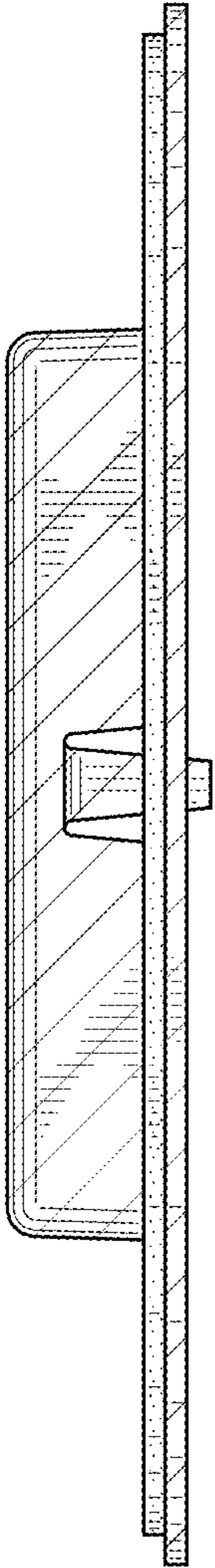

FIG. 5

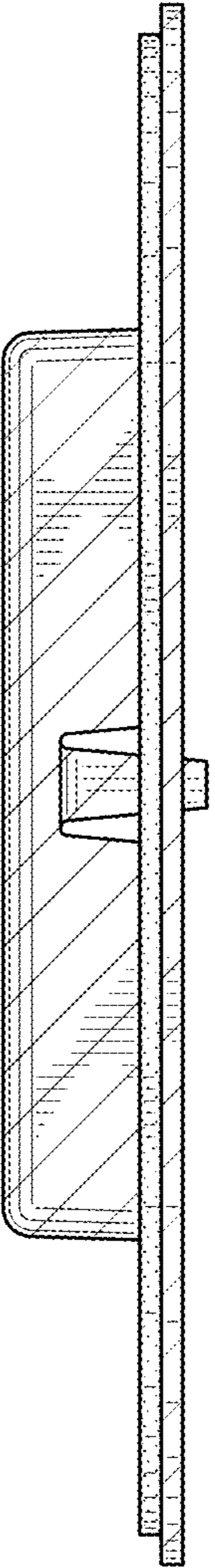

FIG. 6

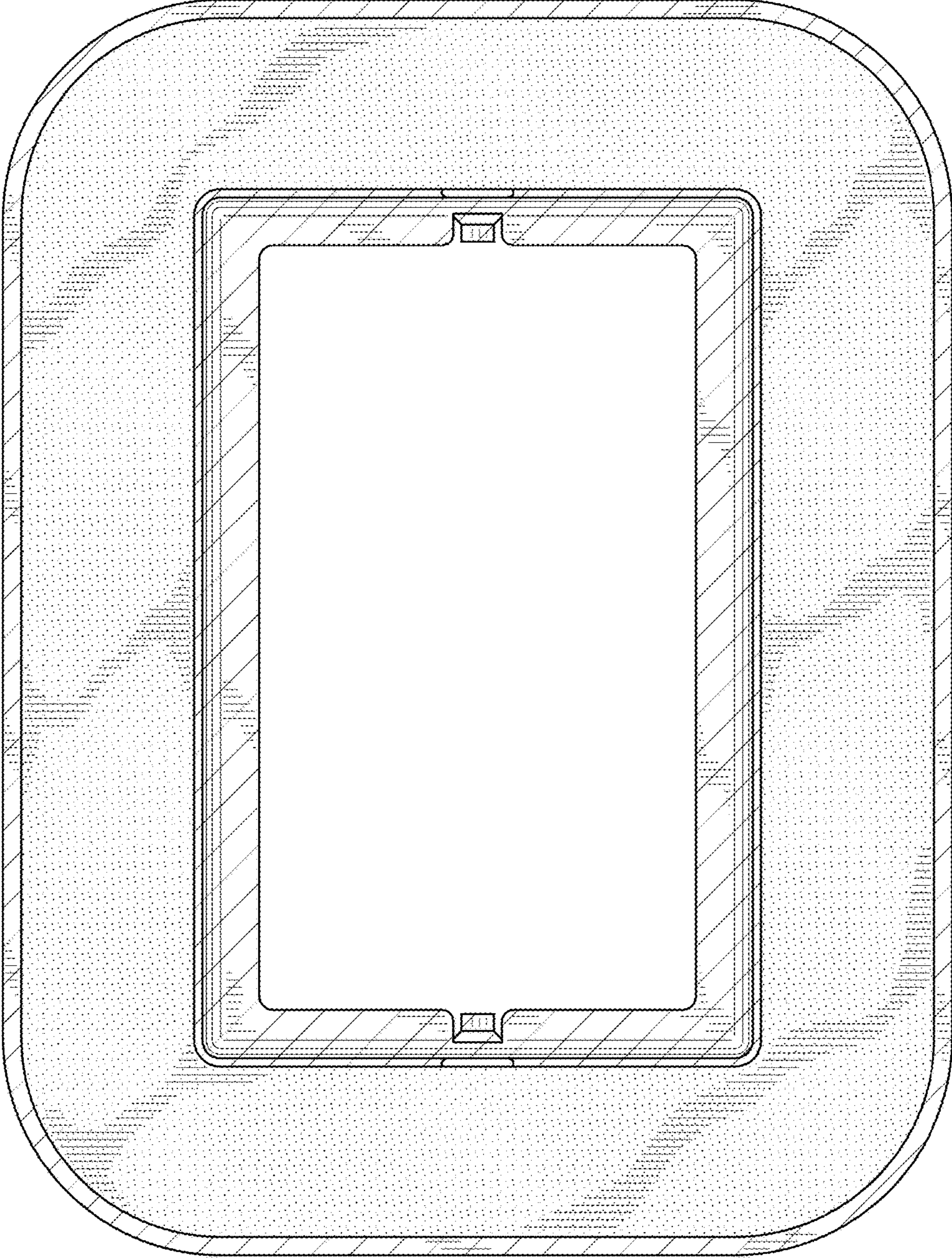

FIG. 7

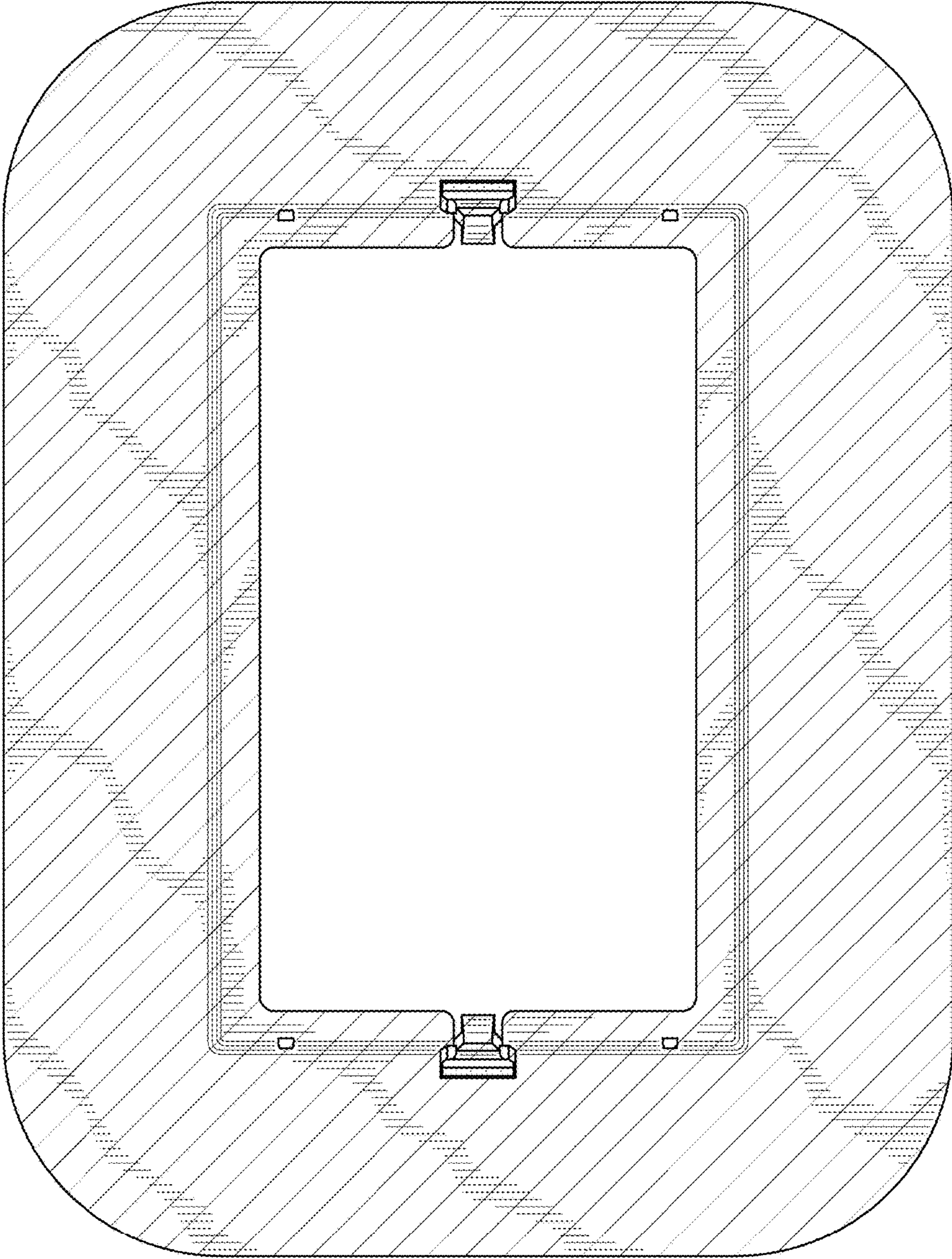

FIG. 8

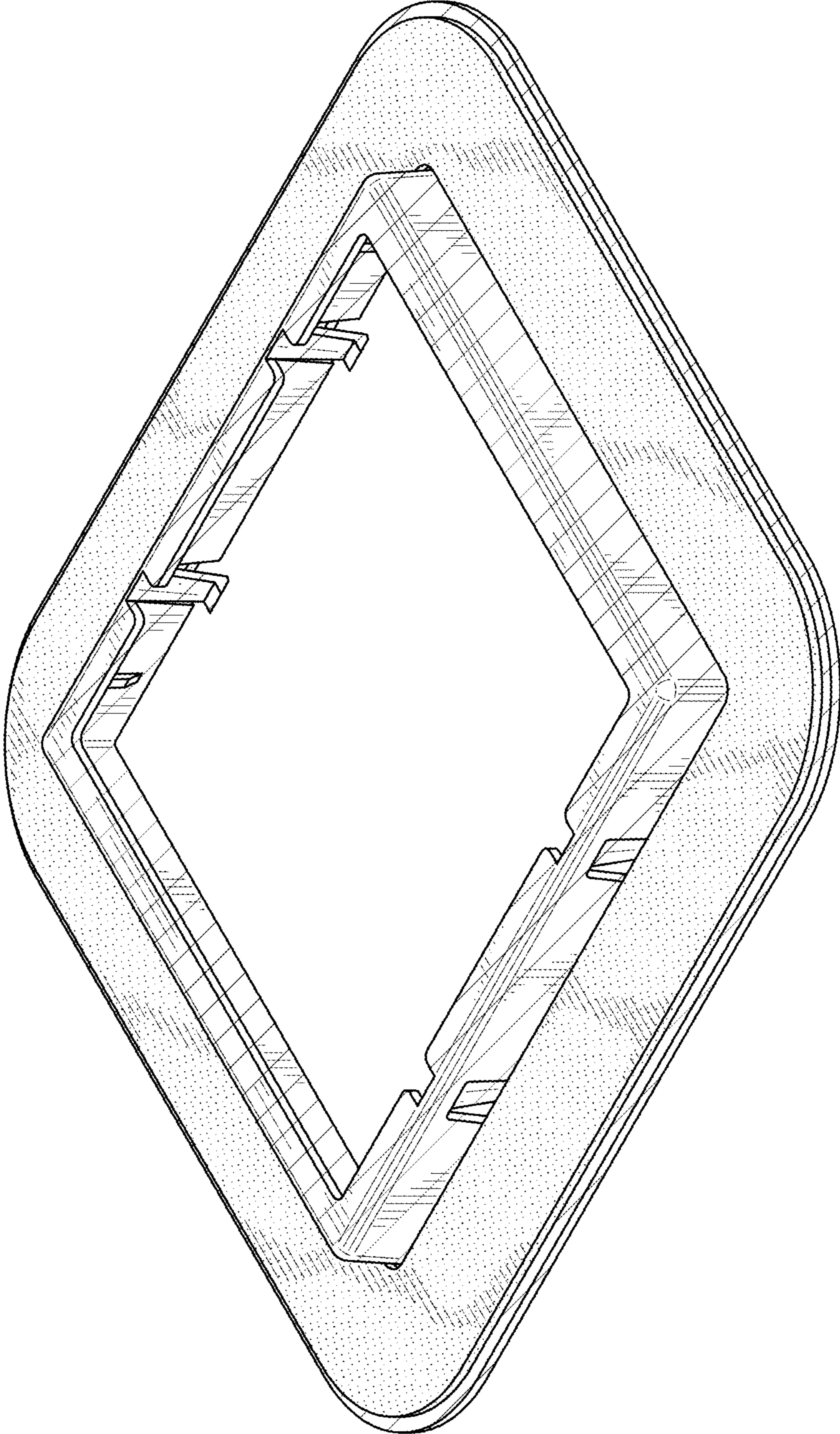

FIG. 9

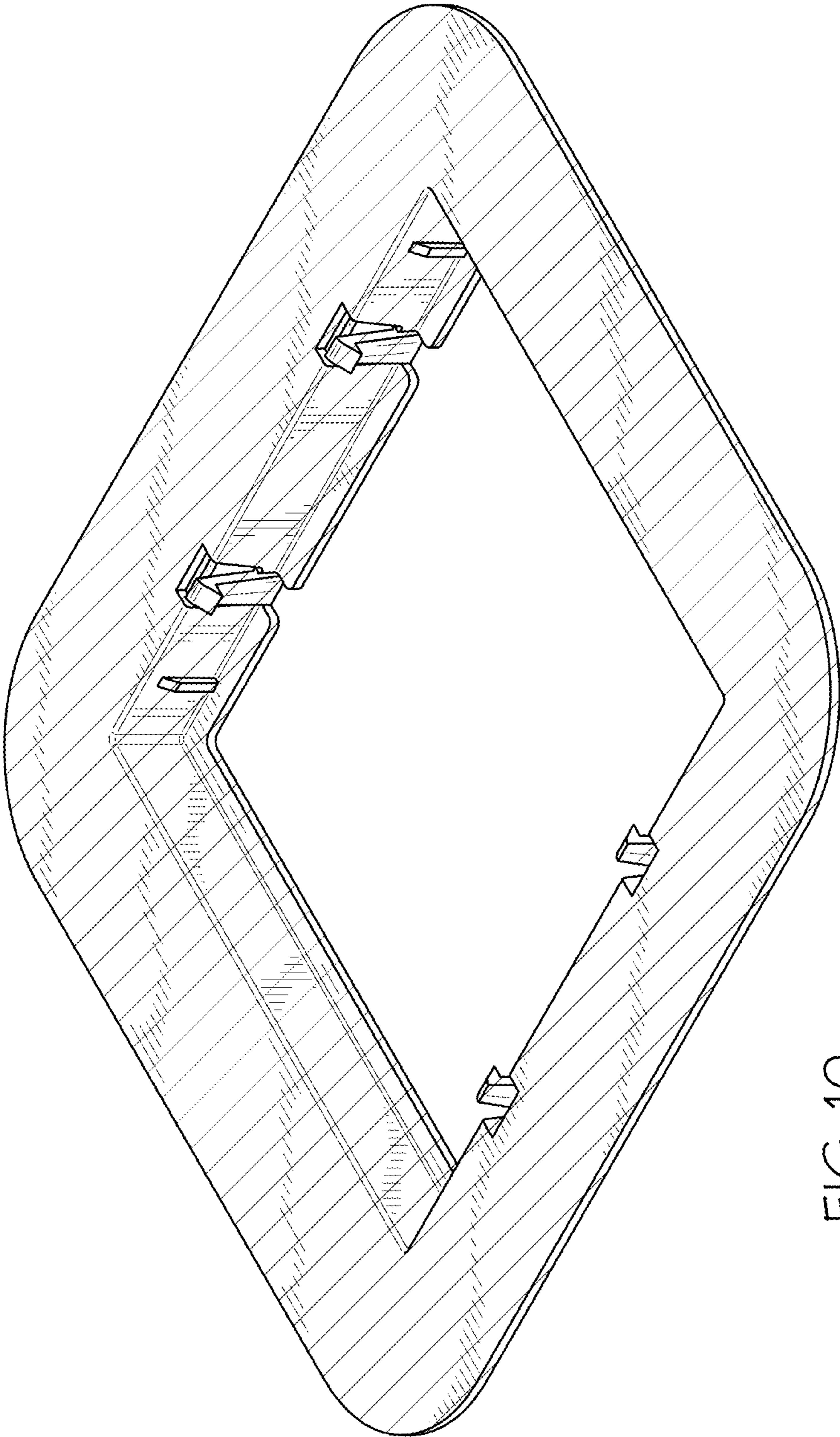

FIG. 10

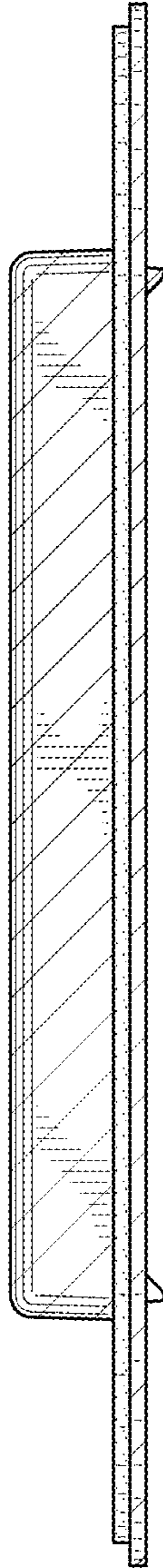

FIG. 11

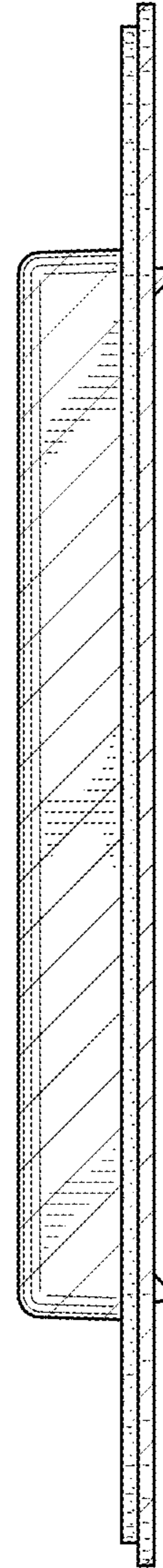

FIG. 12

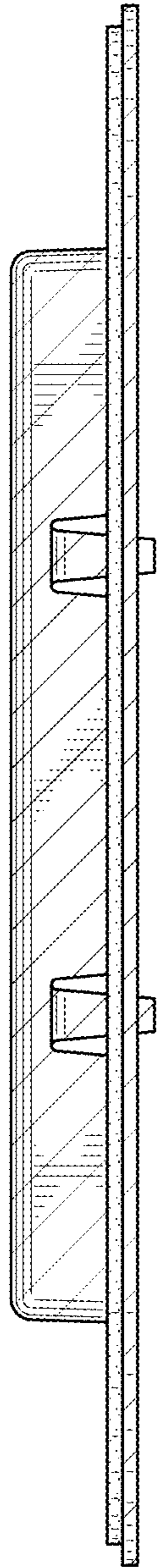

FIG. 13

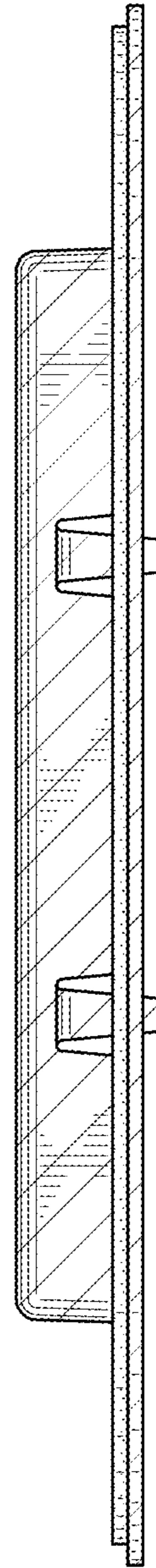

FIG. 14

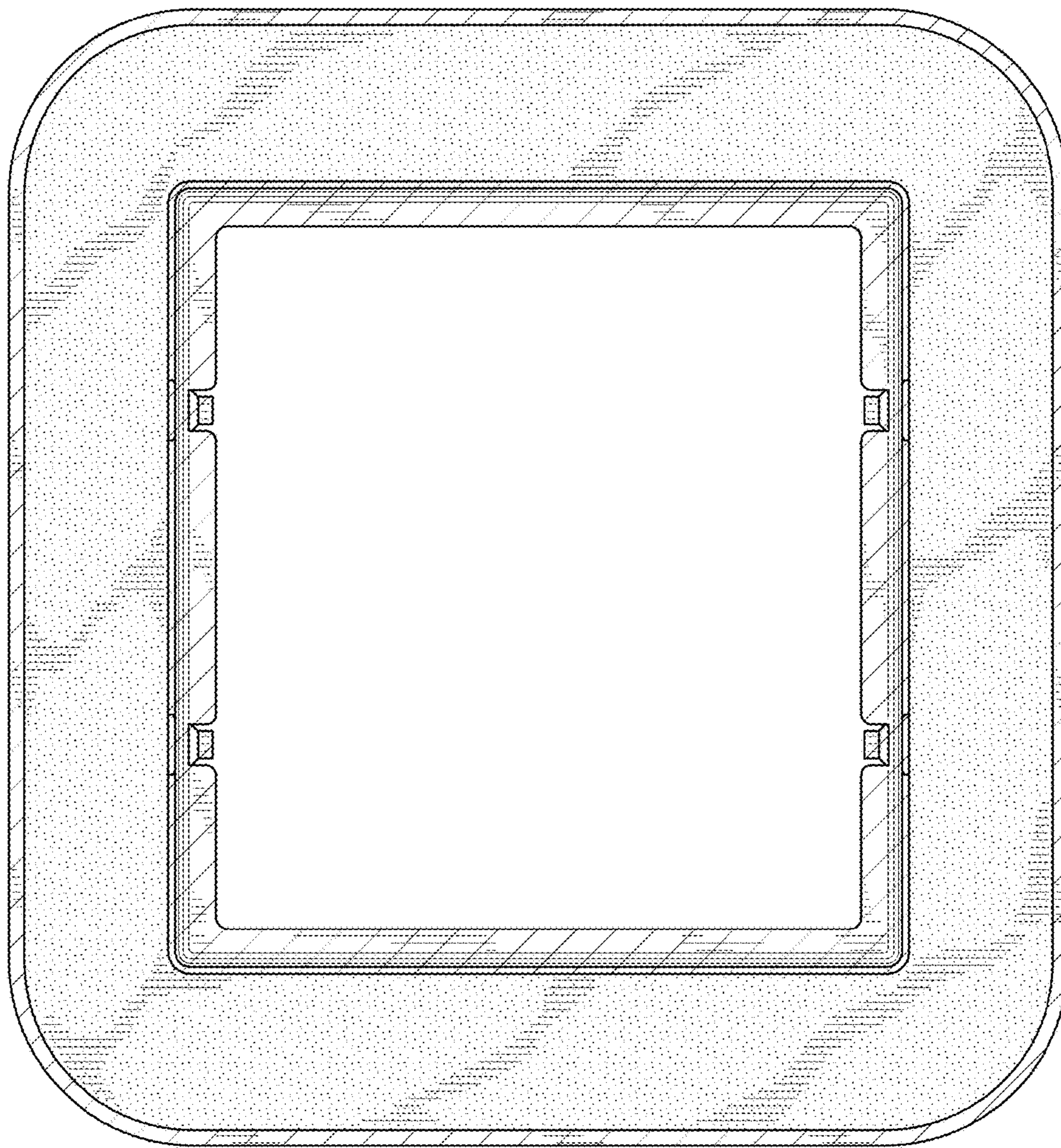

FIG. 15

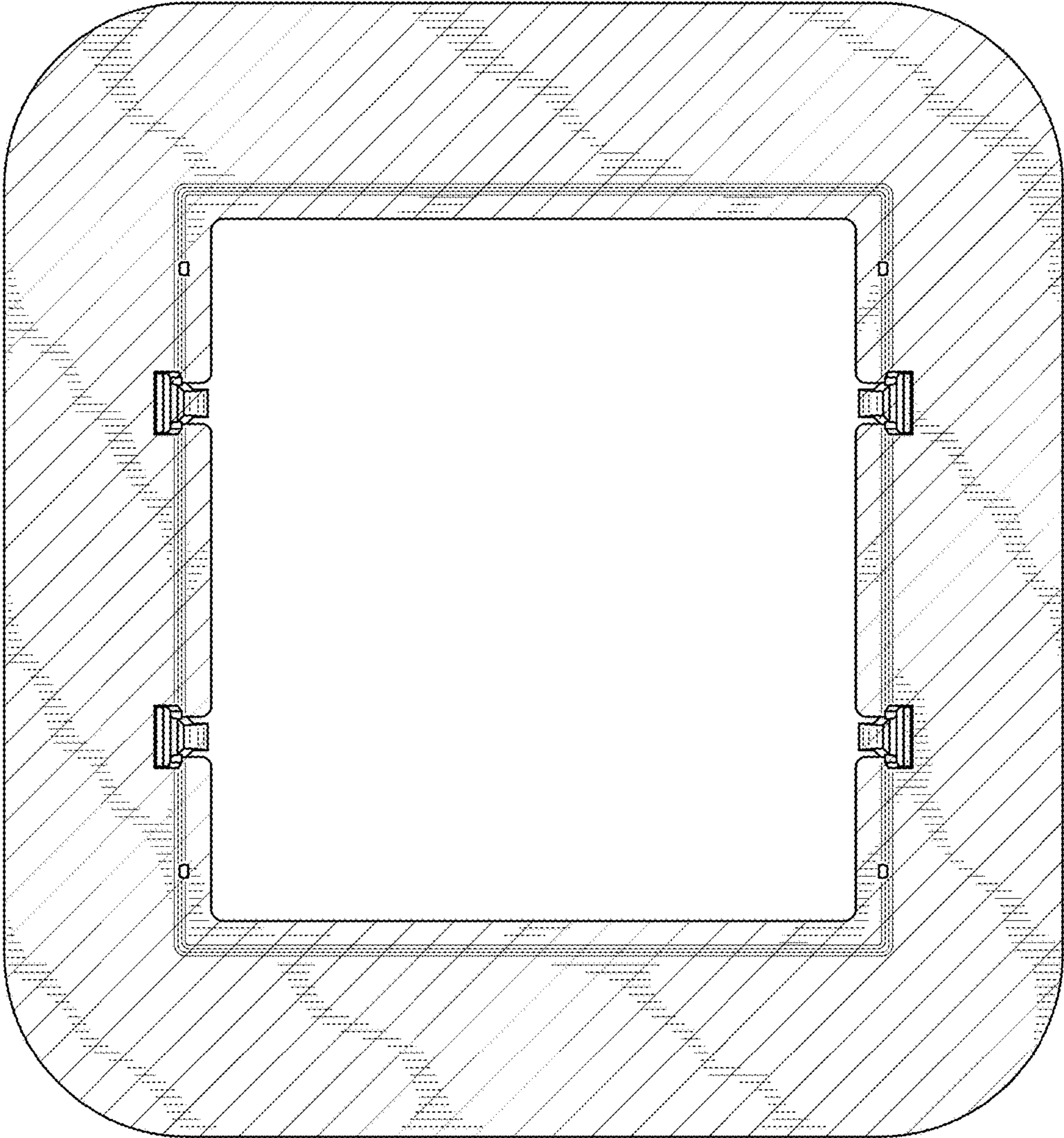

FIG. 16