



US00D774408S

(12) **United States Design Patent** (10) **Patent No.:** **US D774,408 S**
Rymer et al. (45) **Date of Patent:** **** Dec. 20, 2016**

(54) **WAVE-SHAPED ROADWAY RUMBLE STRIP**

(71) Applicant: **State of California, Department of Transportation**, Sacramento, CA (US)

(72) Inventors: **Bruce C. Rymer**, Sacramento, CA (US); **Paul R. Donovan**, Petaluma, CA (US)

(**) Term: **15 Years**

(21) Appl. No.: **29/541,381**

(22) Filed: **Oct. 2, 2015**

Related U.S. Application Data

(63) Continuation of application No. 14/451,638, filed on Aug. 5, 2014, now abandoned.

(51) **LOC (10) Cl.** **10-05**

(52) **U.S. Cl.**
USPC **D10/113.1**

(58) **Field of Classification Search**
USPC D10/113.1, 113.3

(Continued)

(56) **References Cited**

U.S. PATENT DOCUMENTS

5,327,850 A * 7/1994 Sly E01F 9/553
116/63 P
5,392,728 A * 2/1995 Speer E01F 9/553
116/63 R

(Continued)

Primary Examiner — George D Kirschbaum

(74) *Attorney, Agent, or Firm* — Craig A. Simmermon

(57) **CLAIM**

The ornamental design for a wave-shaped roadway rumble strip, as shown and described.

DESCRIPTION

FIG. 1 is a top perspective view of a wave-shaped roadway rumble strip showing my new design.

FIG. 2 is a top plan view thereof.

FIG. 3 is a longitudinal cross sectional view taken along the lines 3-3 in FIG. 2 thereof.

FIG. 4 is a lateral cross sectional view taken along the lines 4-4 in FIG. 2 thereof.

FIG. 5 is an enlarged view thereof.

FIG. 6 is another top perspective view thereof.

FIG. 7 is another top plan view thereof.

FIG. 8 is a top perspective view of a second embodiment of my design.

FIG. 9 is a top plan view thereof.

FIG. 10 is a longitudinal cross sectional view taken along the lines 10-10 in FIG. 9 thereof.

FIG. 11 is a lateral cross sectional view taken along the lines 11-11 in FIG. 9 thereof.

FIG. 12 is a top perspective view of a third embodiment of my new design.

FIG. 13 is a top plan view thereof.

FIG. 14 is a longitudinal cross sectional view taken along the lines 14-14 in FIG. 13 thereof.

FIG. 15 is a lateral cross sectional view taken along the lines 15-15 in FIG. 13 thereof.

FIG. 16 is a top perspective view of a fourth embodiment of my new design.

FIG. 17 is a top plan view thereof.

FIG. 18 is a longitudinal cross sectional view taken along the lines 18-18 in FIG. 17 thereof.

FIG. 19 is a lateral cross sectional view taken along the lines 19-19 in FIG. 17 thereof.

FIG. 20 is an enlarged view thereof.

FIG. 21 is another top perspective view thereof.

FIG. 22 is another top plan view thereof.

FIG. 23 is a top perspective view of a fifth embodiment of my new design.

FIG. 24 is a top plan view thereof.

FIG. 25 is a longitudinal cross sectional view taken along the lines 25-25 in FIG. 24 thereof.

FIG. 26 is a lateral cross sectional view taken along the lines 26-26 in FIG. 24 thereof.

FIG. 27 is a top perspective view of a sixth embodiment of my new design.

FIG. 28 is a top plan view thereof.

(Continued)

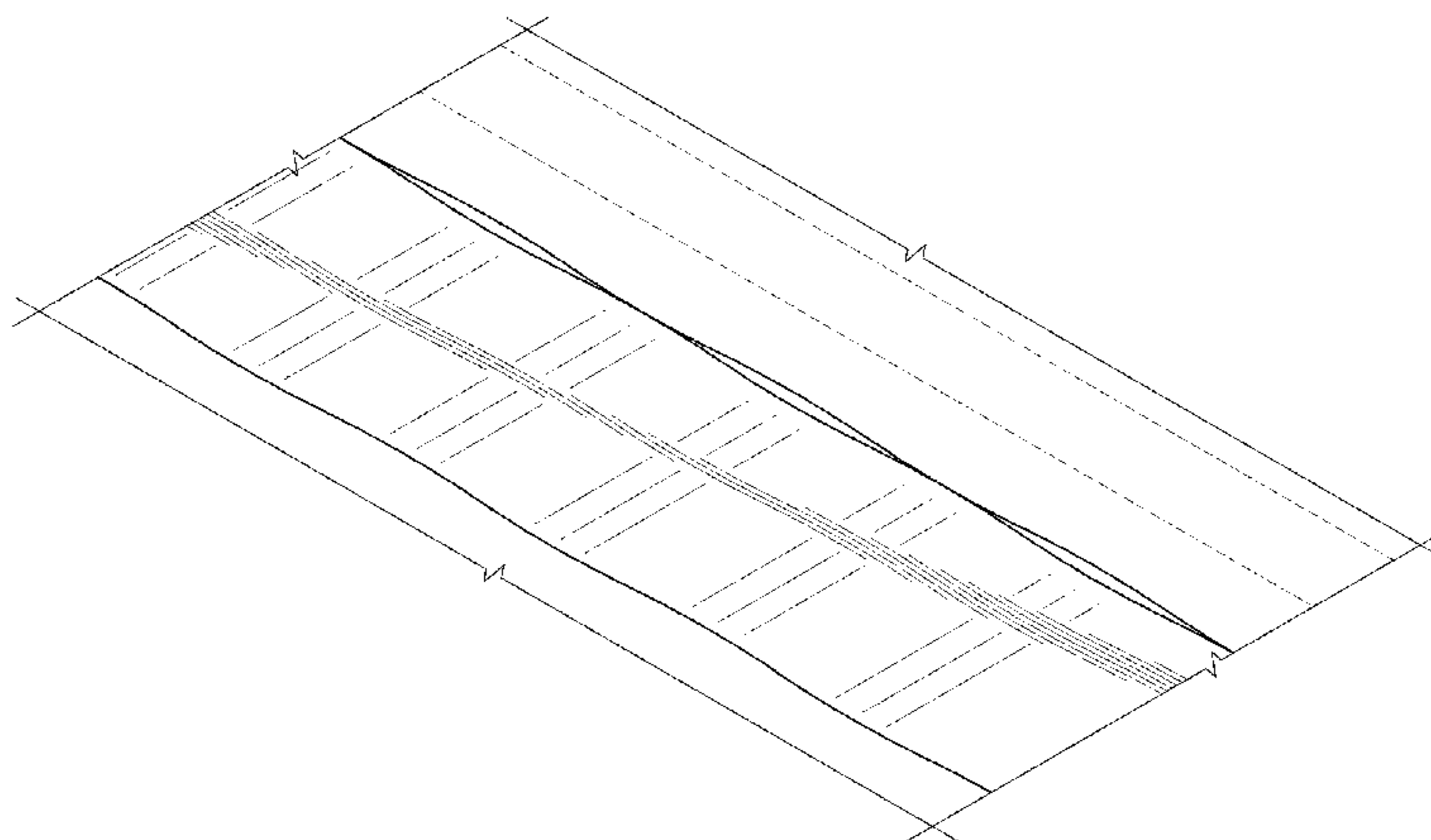

FIG. 29 is a longitudinal cross sectional view taken along the lines 29-29 in FIG. 28 thereof.
 FIG. 30 is a lateral cross sectional view taken along the lines 30-30 in FIG. 29 thereof.
 FIG. 31 is a top perspective view of a seventh embodiment of my new design.
 FIG. 32 is a top plan view thereof.
 FIG. 33 is a longitudinal cross sectional view taken along the lines 33-33 in FIG. 32 thereof.
 FIG. 34 is a lateral cross sectional view taken along the lines 34-34 in FIG. 32 thereof.
 FIG. 35 is an enlarged view thereof.
 FIG. 36 is another top perspective view thereof.
 FIG. 37 is another top plan view thereof.
 FIG. 38 is a top perspective view of eighth embodiment of my new design.
 FIG. 39 is a top plan view thereof.
 FIG. 40 is a longitudinal cross sectional view taken along the lines 40-40 in FIG. 39 thereof.
 FIG. 41 is a lateral cross sectional view taken along the lines 41-41 in FIG. 39 thereof.
 FIG. 42 is a top perspective view of a ninth embodiment of my new design.
 FIG. 43 is a top plan view thereof.
 FIG. 44 is a longitudinal cross sectional view taken along the lines 44-44 in FIG. 43 thereof; and,
 FIG. 45 is a lateral cross sectional view taken along the lines 45-45 in FIG. 43 thereof.

Broken lines in the drawings represent unclaimed environmental subject matter and form no part of the claimed design.

1 Claim, 36 Drawing Sheets

(58) **Field of Classification Search**
 CPC E01F 9/553; E01F 9/512; E01F 9/529;
 G01M 17/06; E01C 5/08
 See application file for complete search history.

(56) **References Cited**

U.S. PATENT DOCUMENTS

5,769,563	A *	6/1998	Flynn	E01F 9/512 116/63 P
7,118,305	B1 *	10/2006	Corbett	E01F 13/12 404/6
7,302,825	B2 *	12/2007	Knox	G01M 17/06 73/11.04
7,625,152	B2 *	12/2009	Swamidass	E01F 9/529 404/12
7,731,448	B2 *	6/2010	Fillie	E01F 9/529 404/15
7,736,087	B1 *	6/2010	Mettler	E01F 9/529 116/63 P
7,950,276	B1 *	5/2011	Freyhof	E01O 5/08 73/146

* cited by examiner

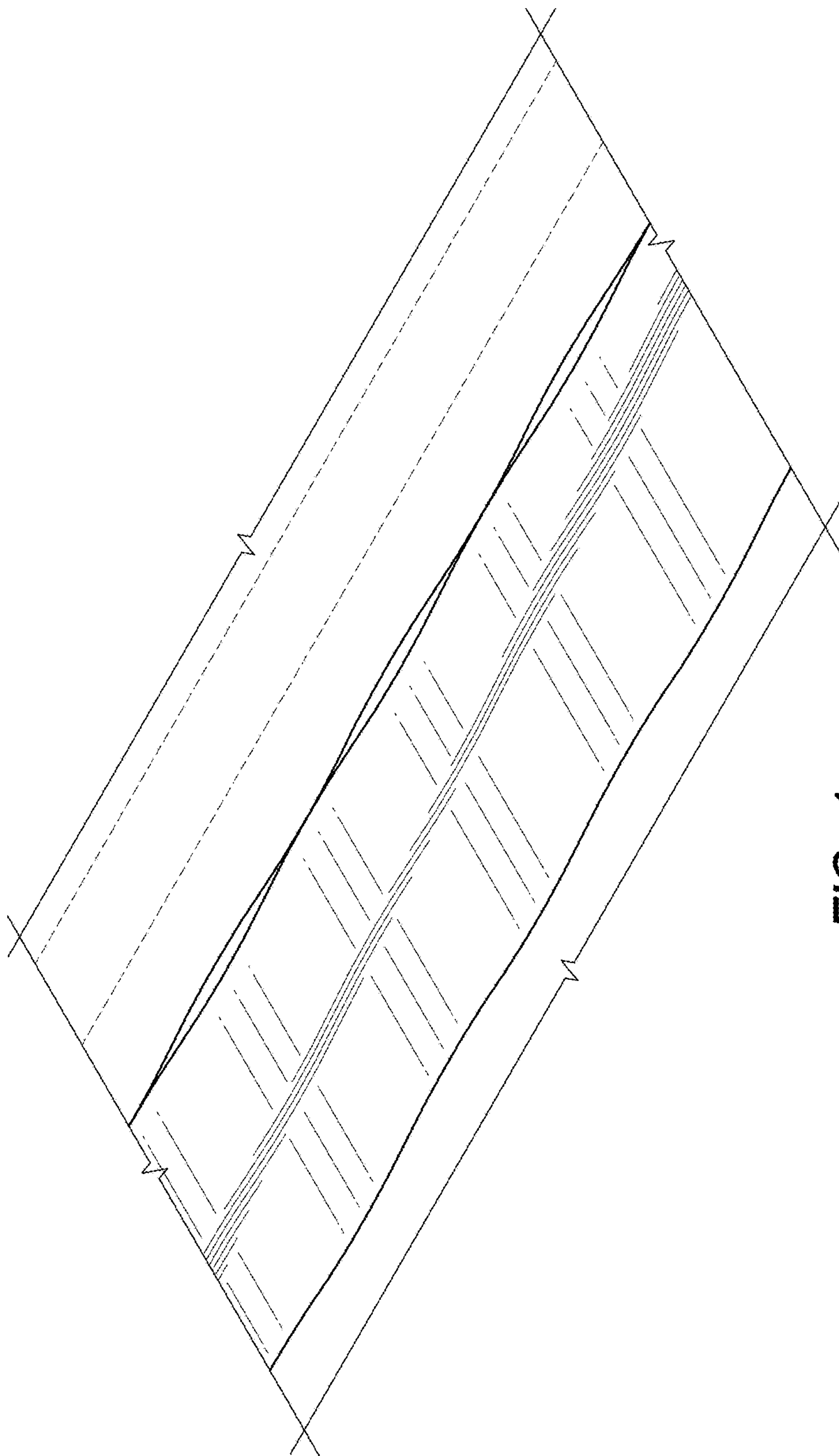

FIG. 1

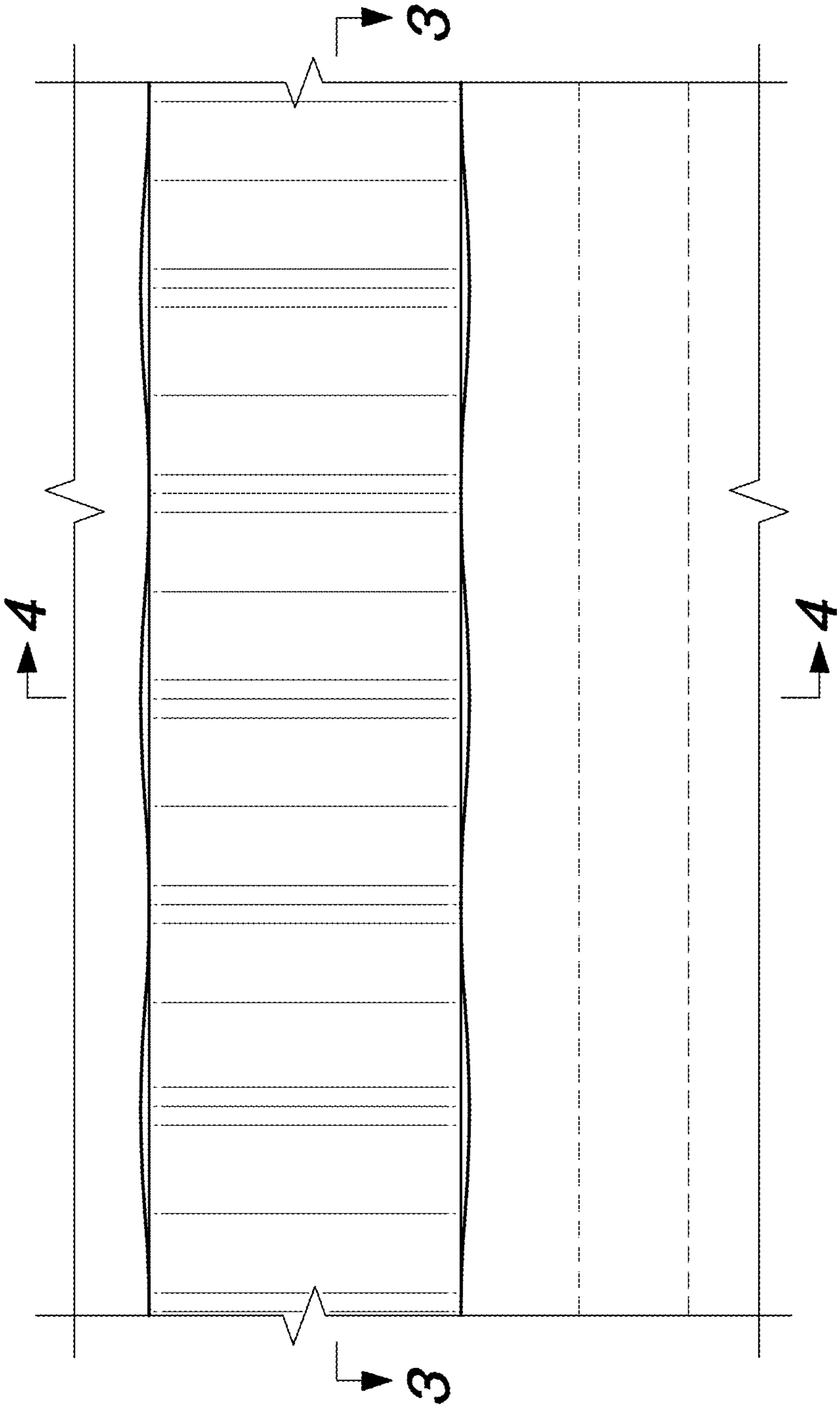

FIG. 2

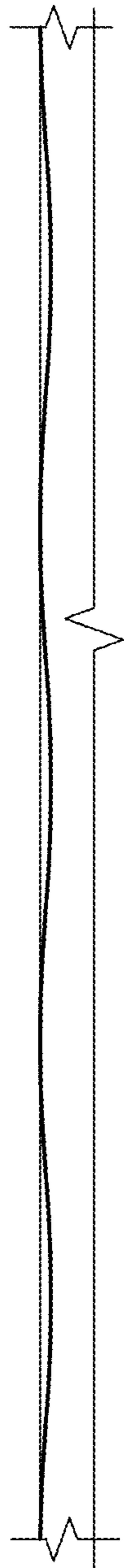

FIG. 3

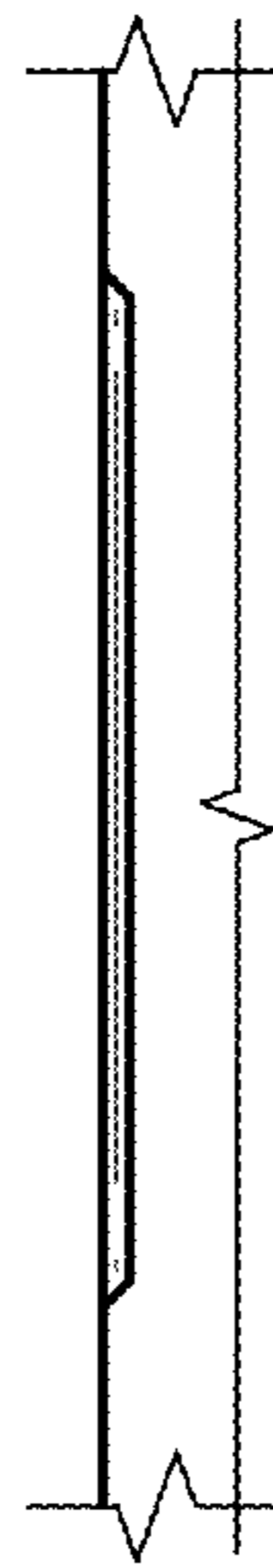

FIG. 4

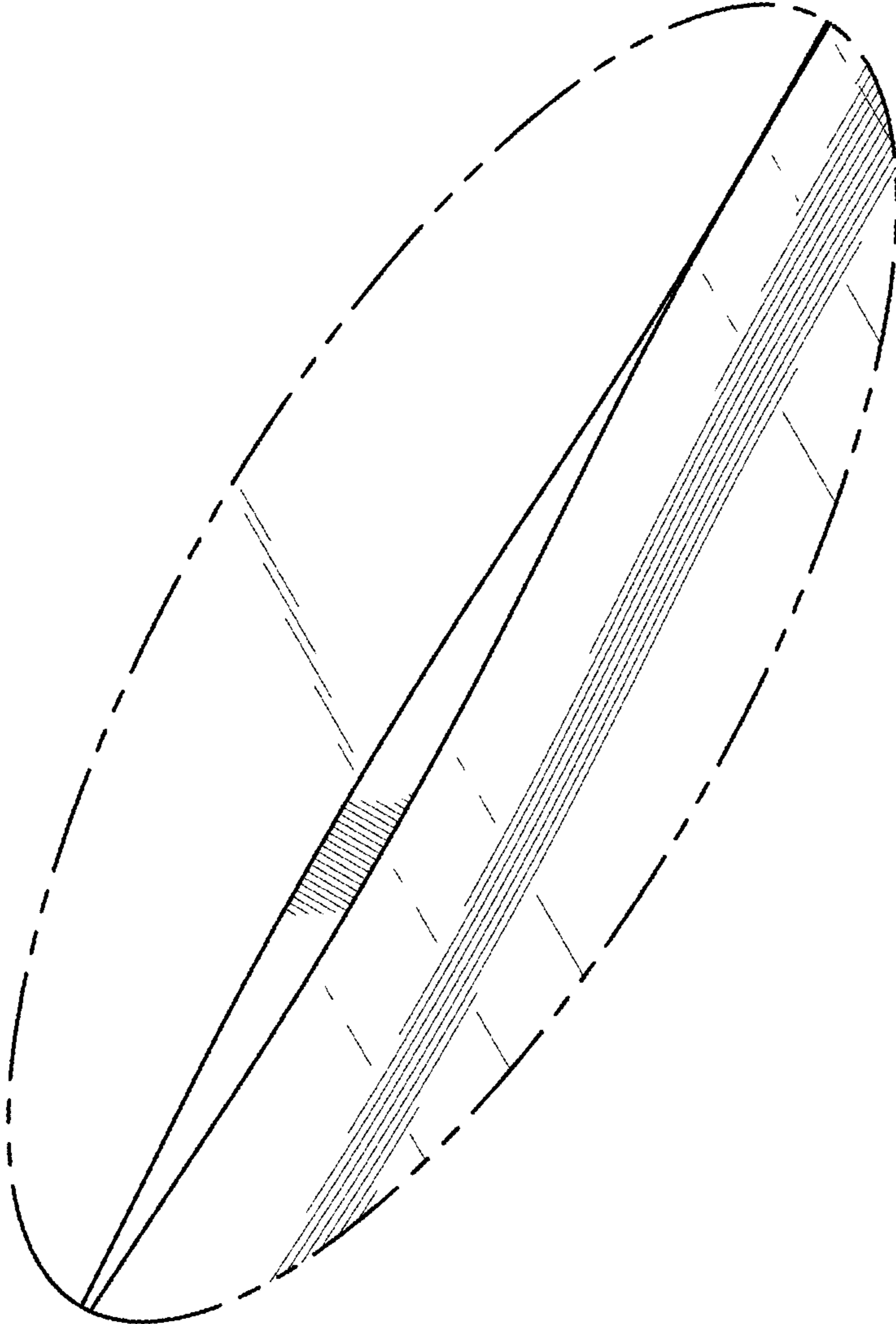

FIG. 5

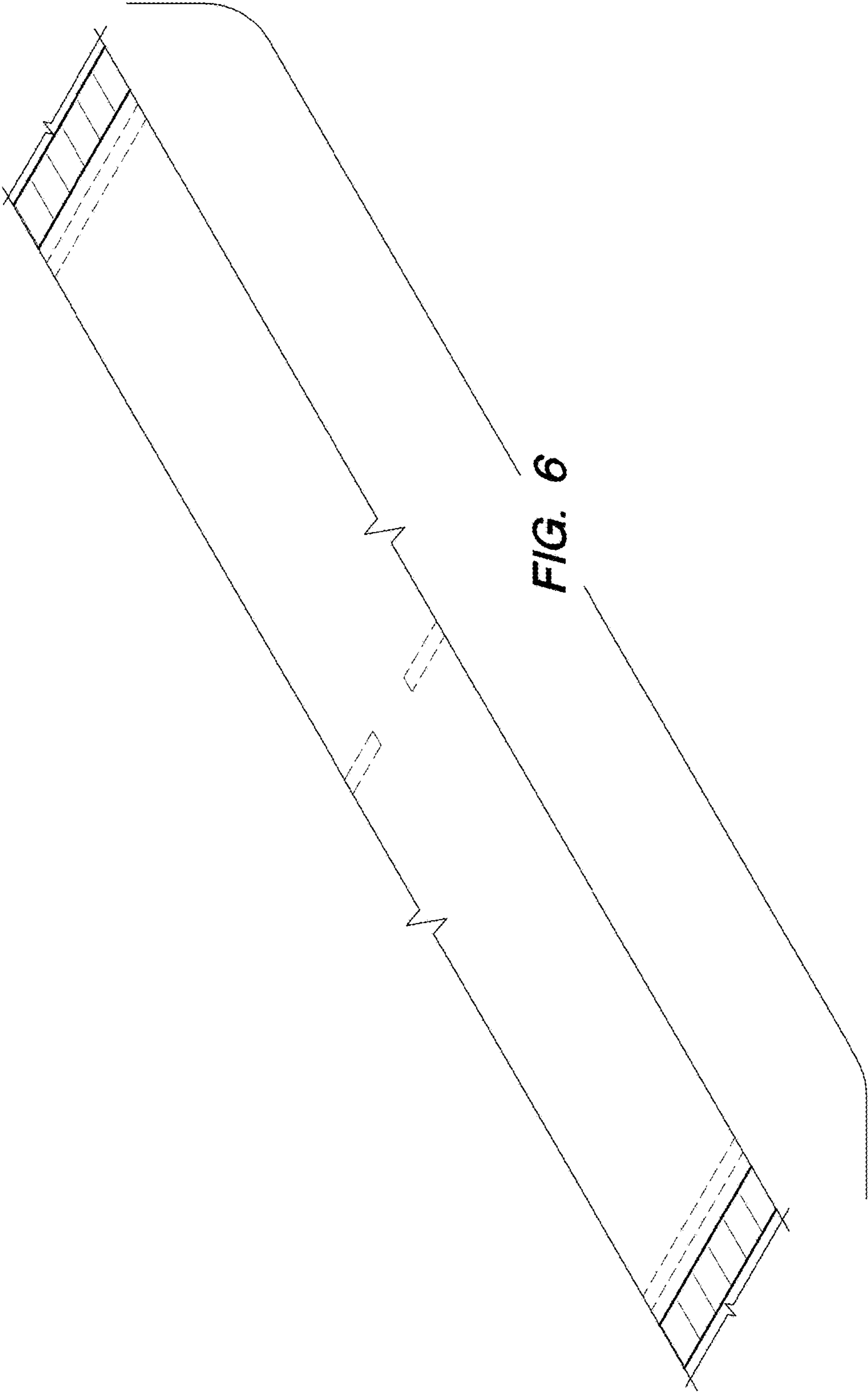

FIG. 6

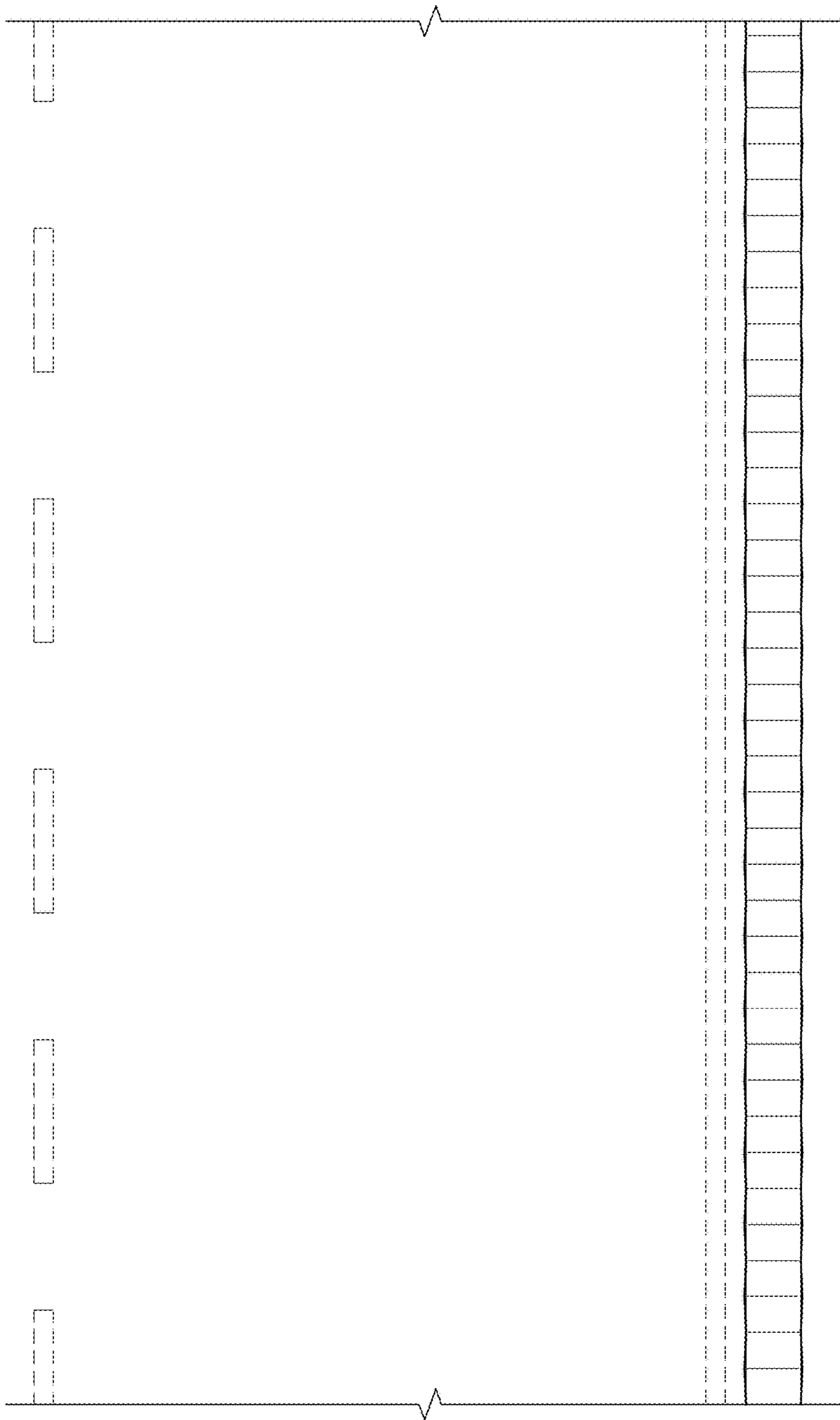

FIG. 7

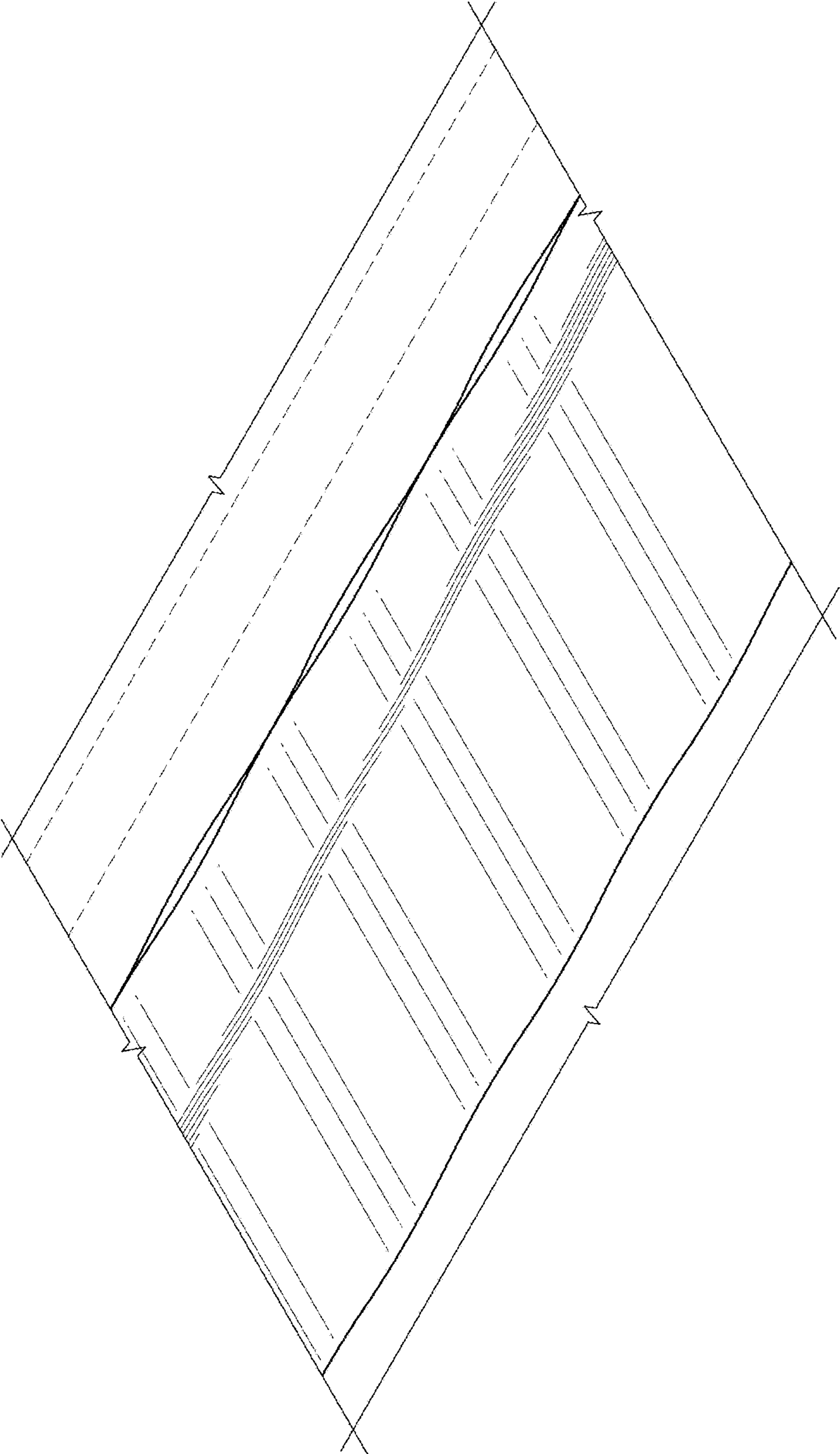

FIG. 8

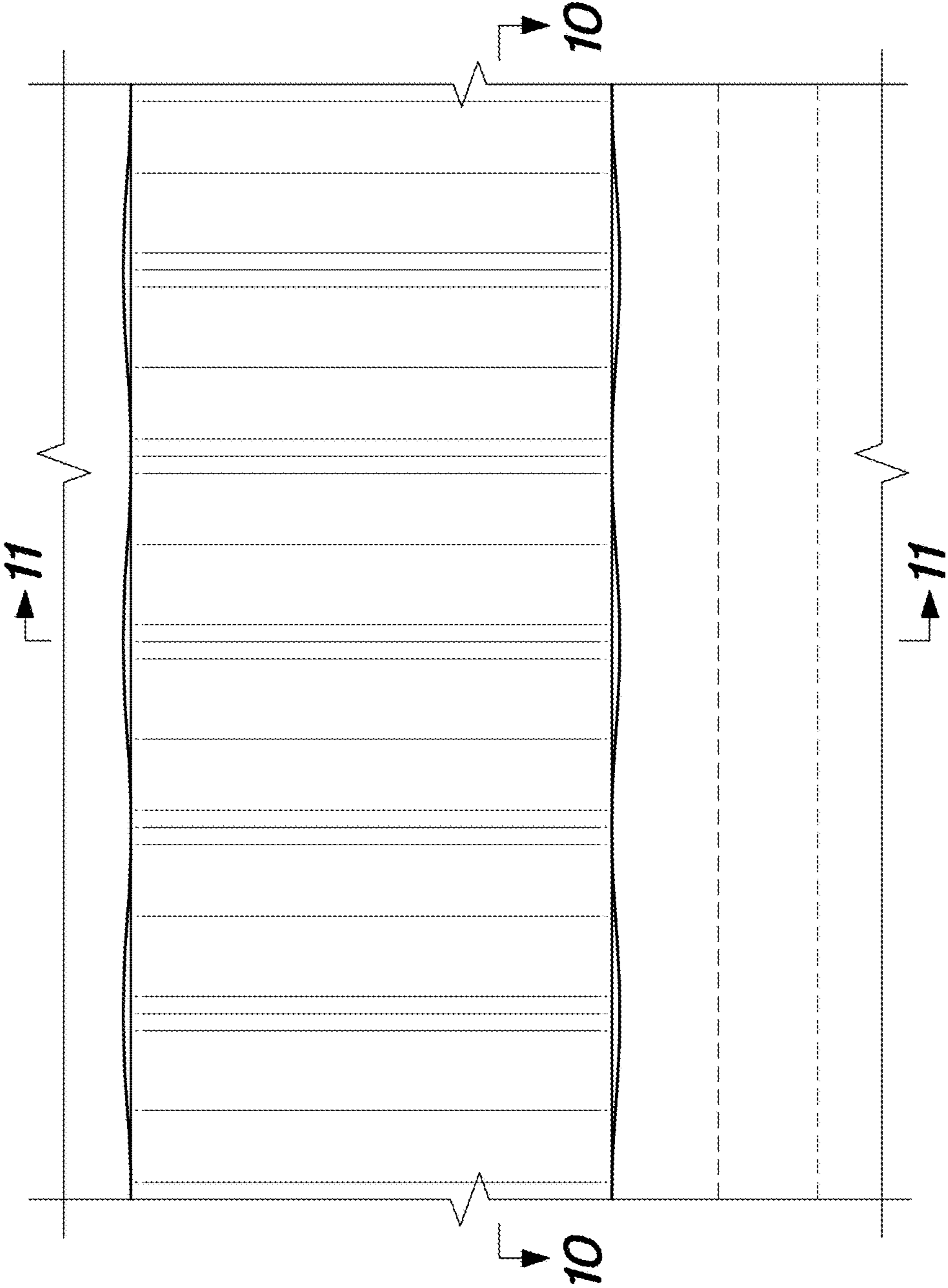

FIG. 9

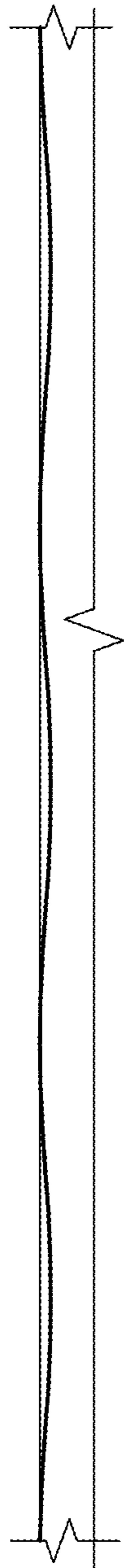

FIG. 10

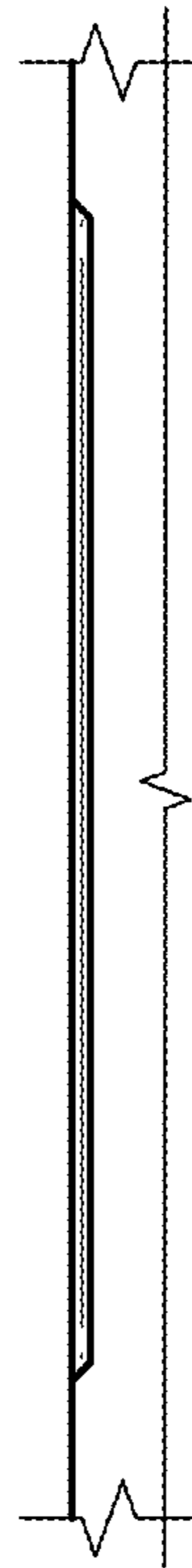

FIG. 11

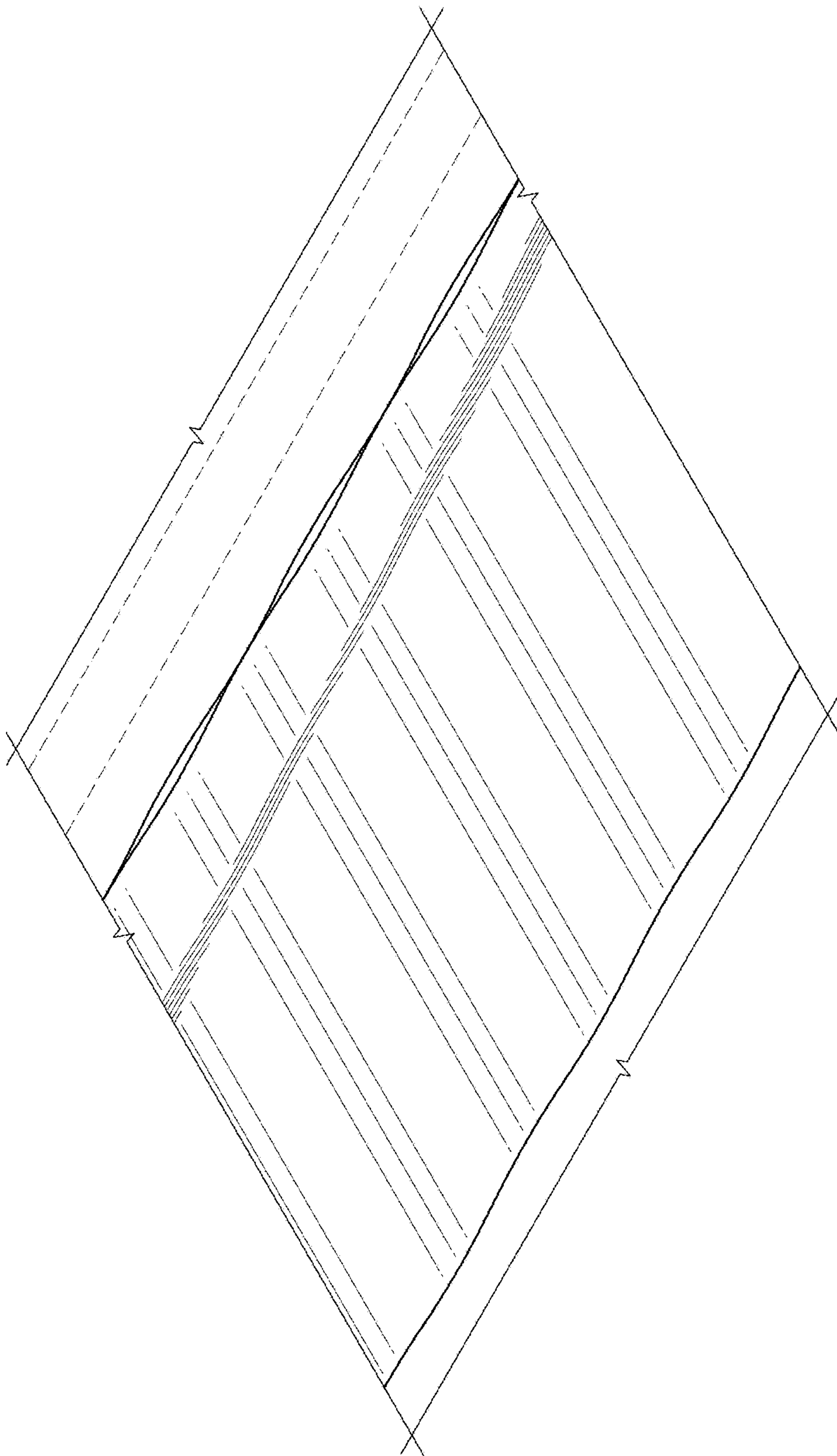

FIG. 12

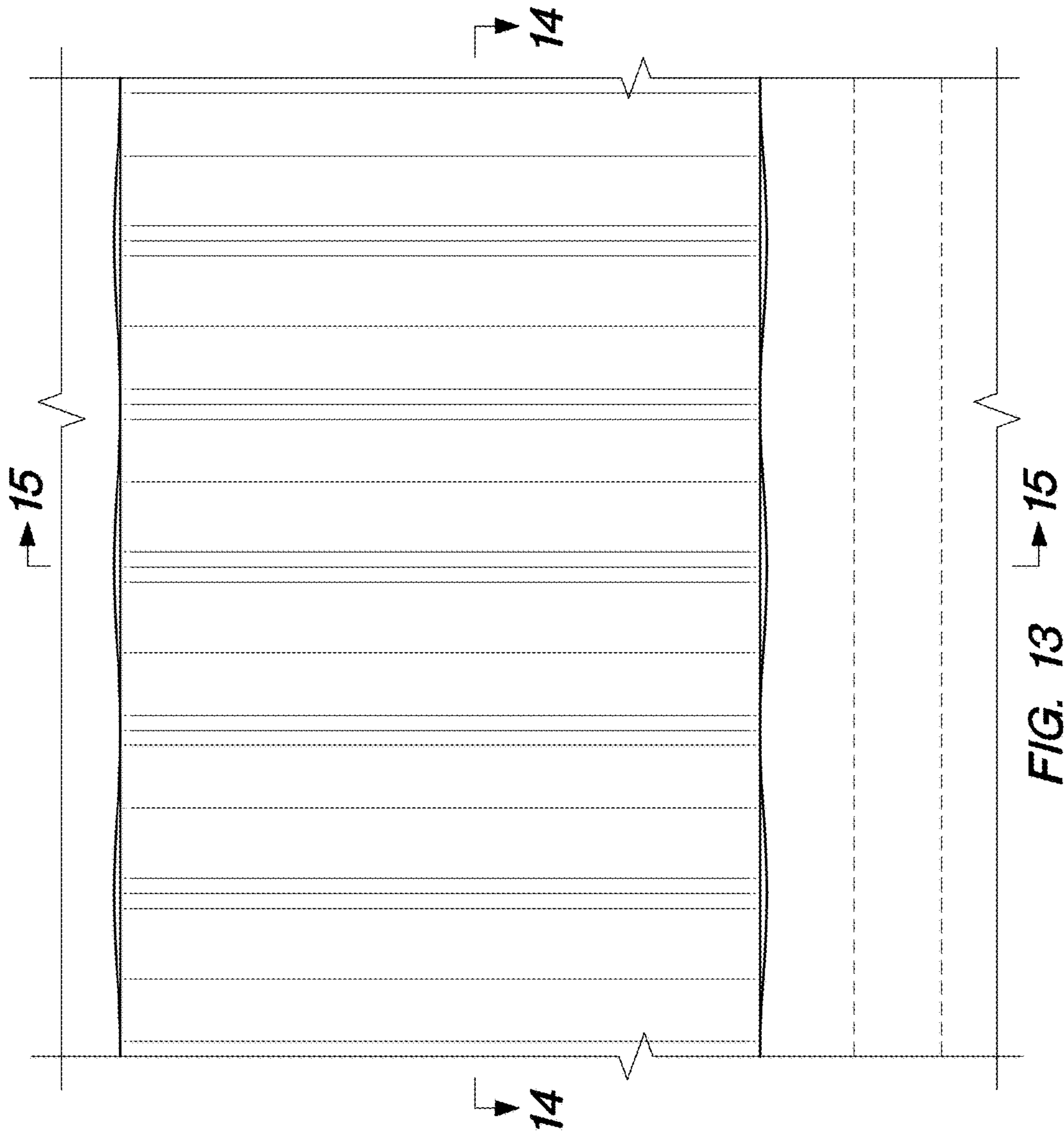

FIG. 13

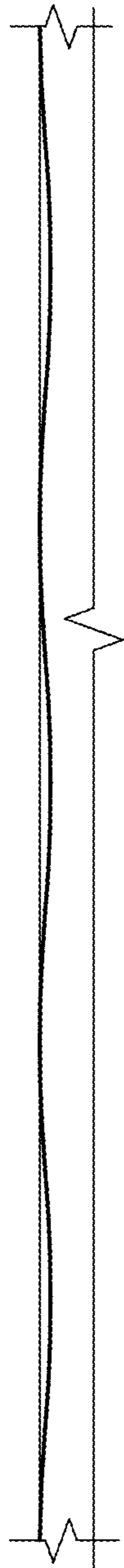

FIG. 14

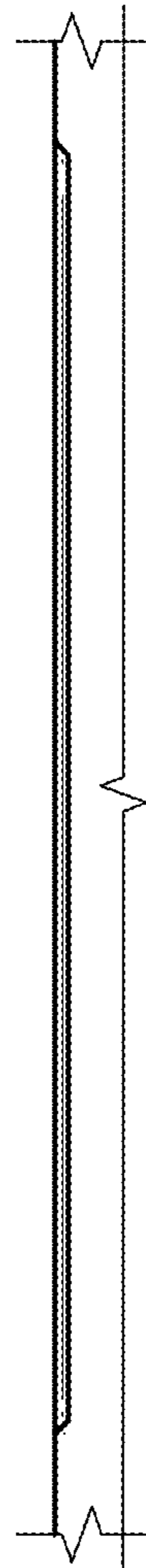

FIG. 15

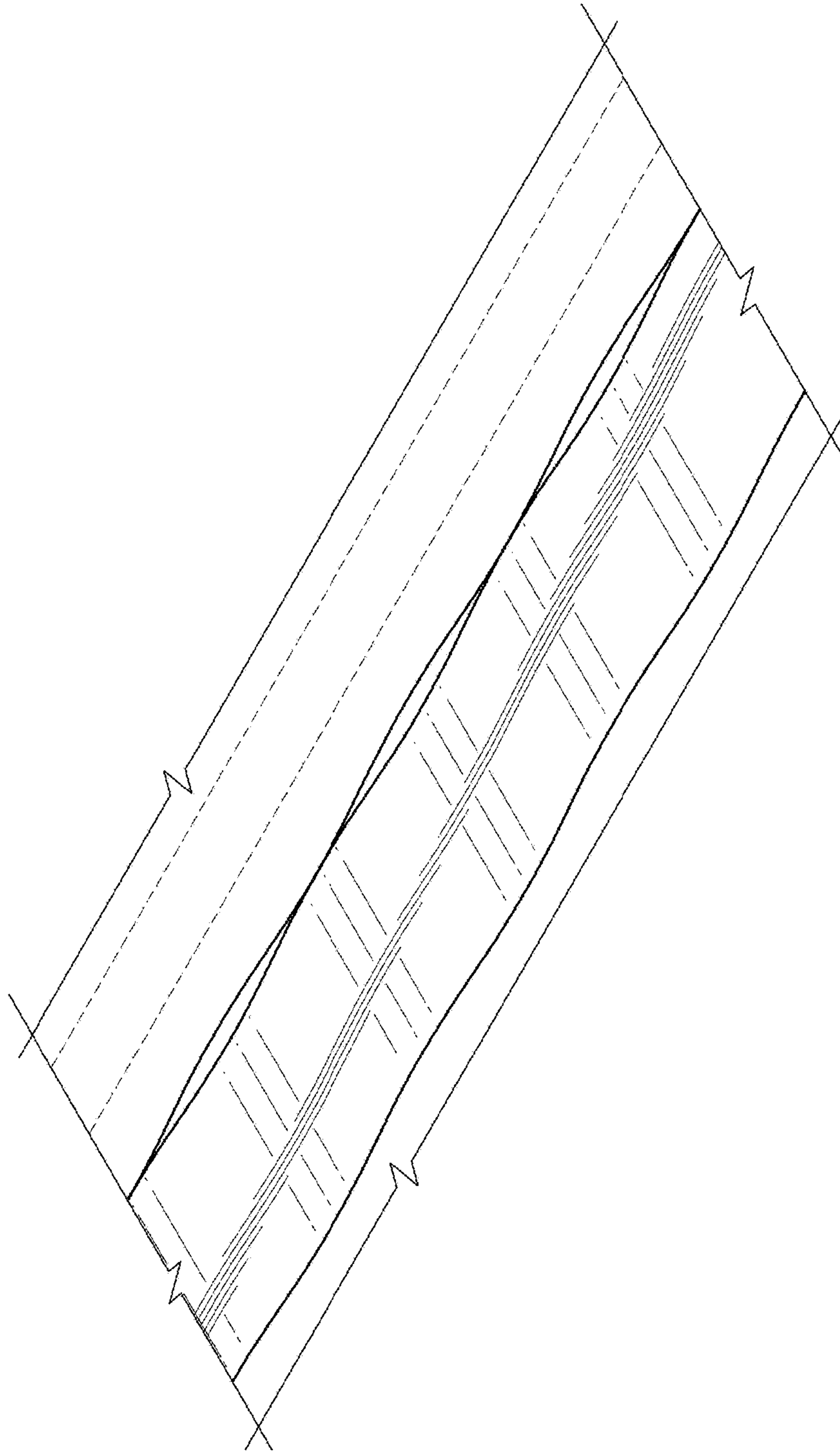

FIG. 16

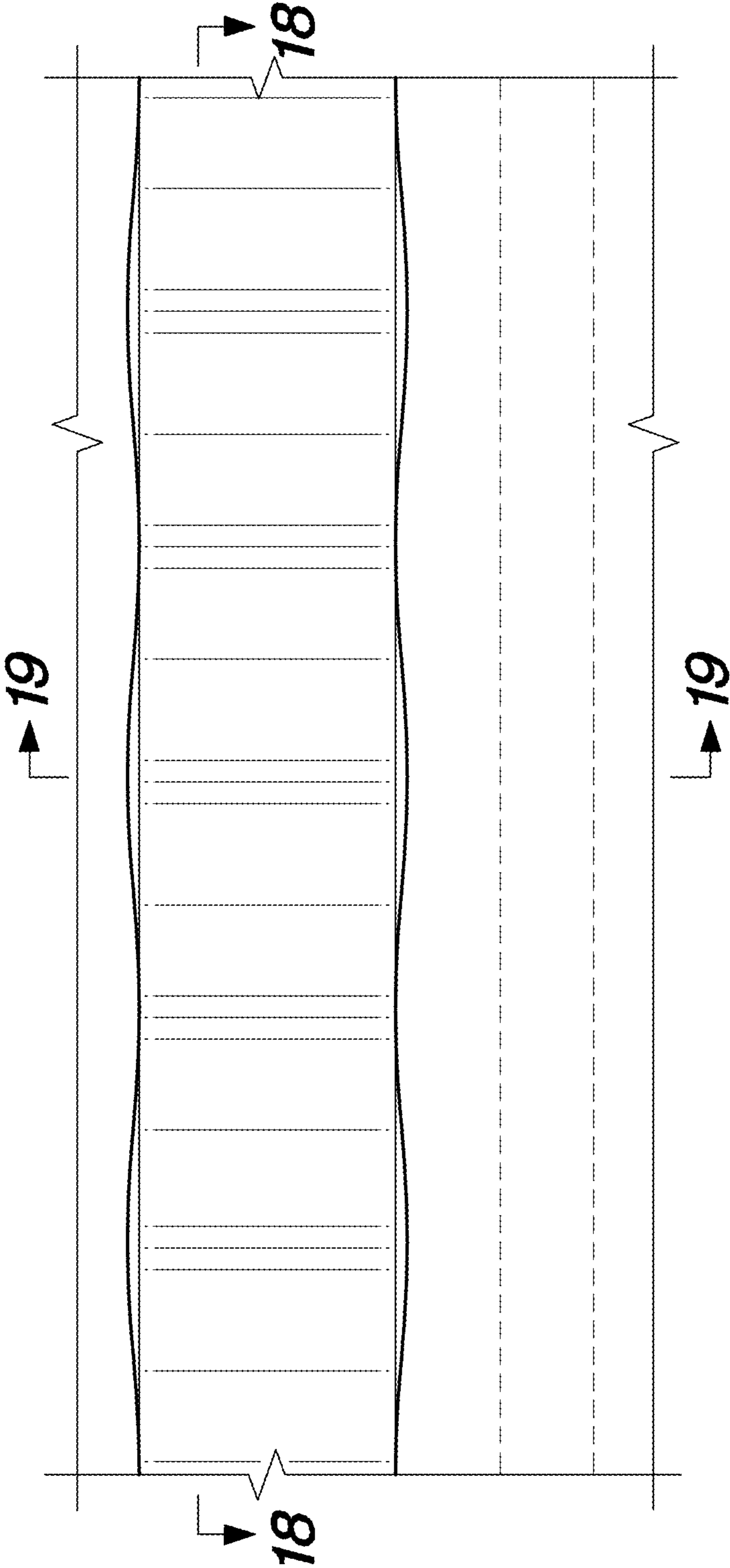

FIG. 17

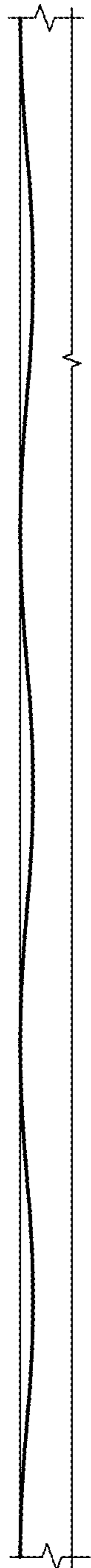

FIG. 18



FIG. 19

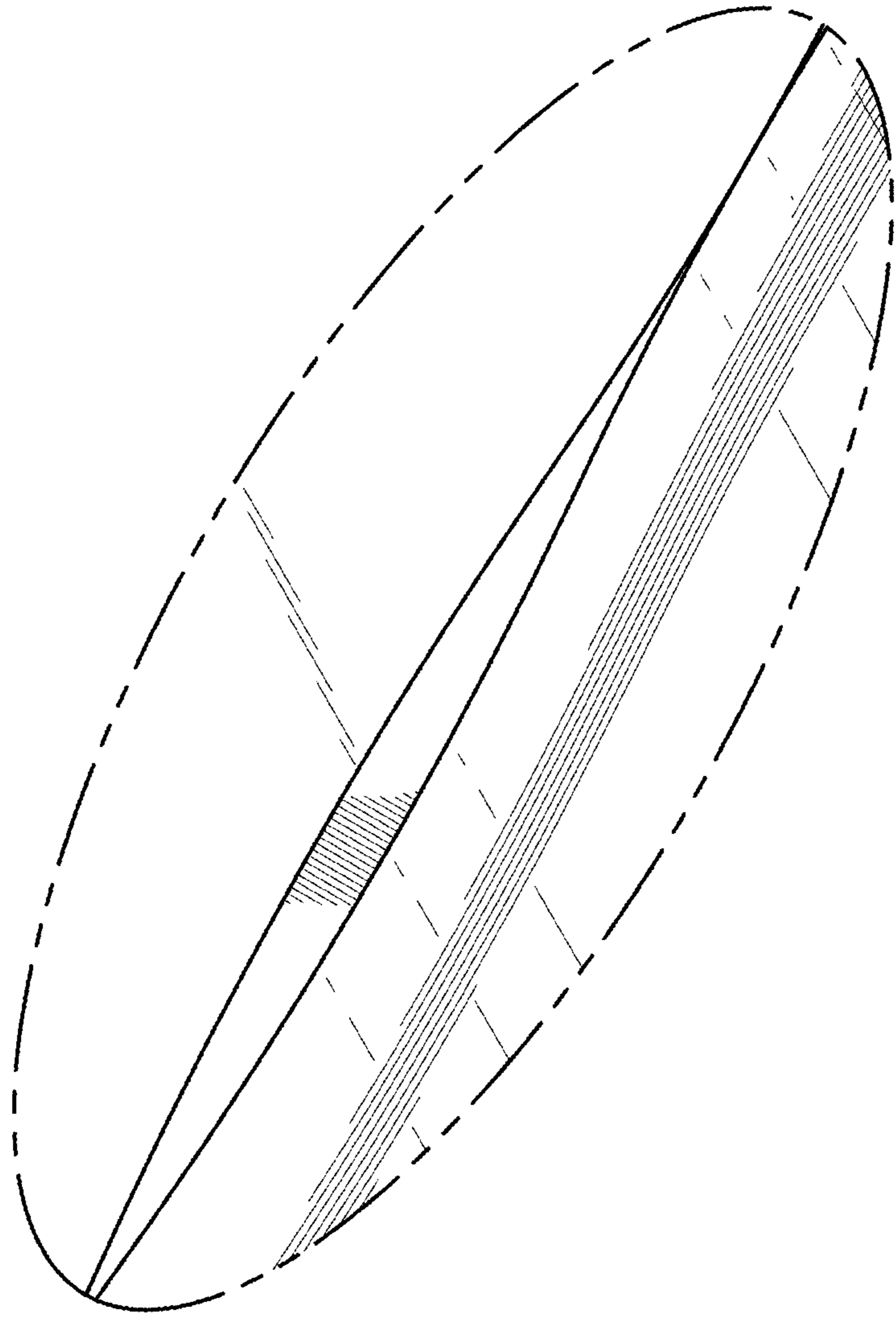
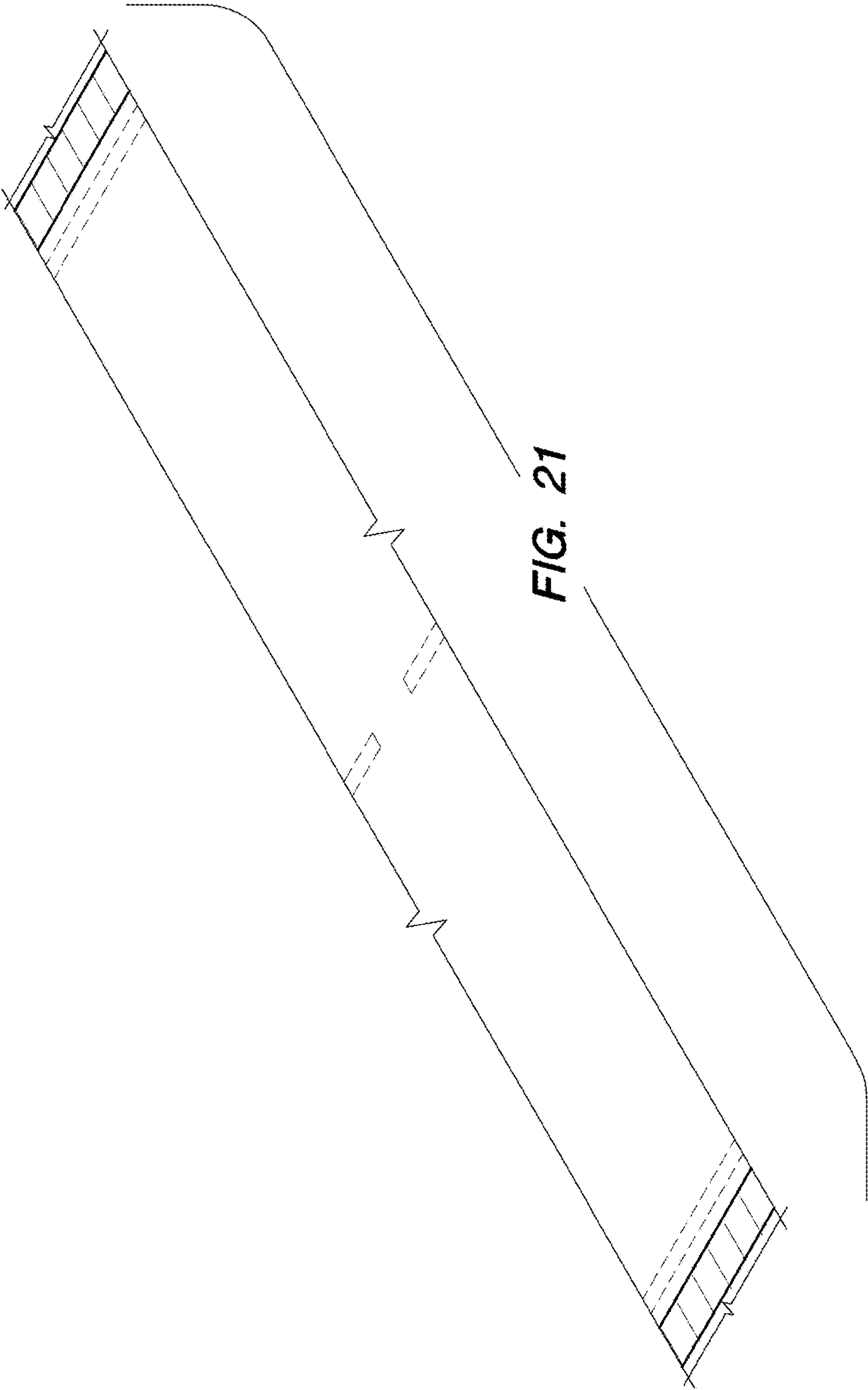

FIG. 20



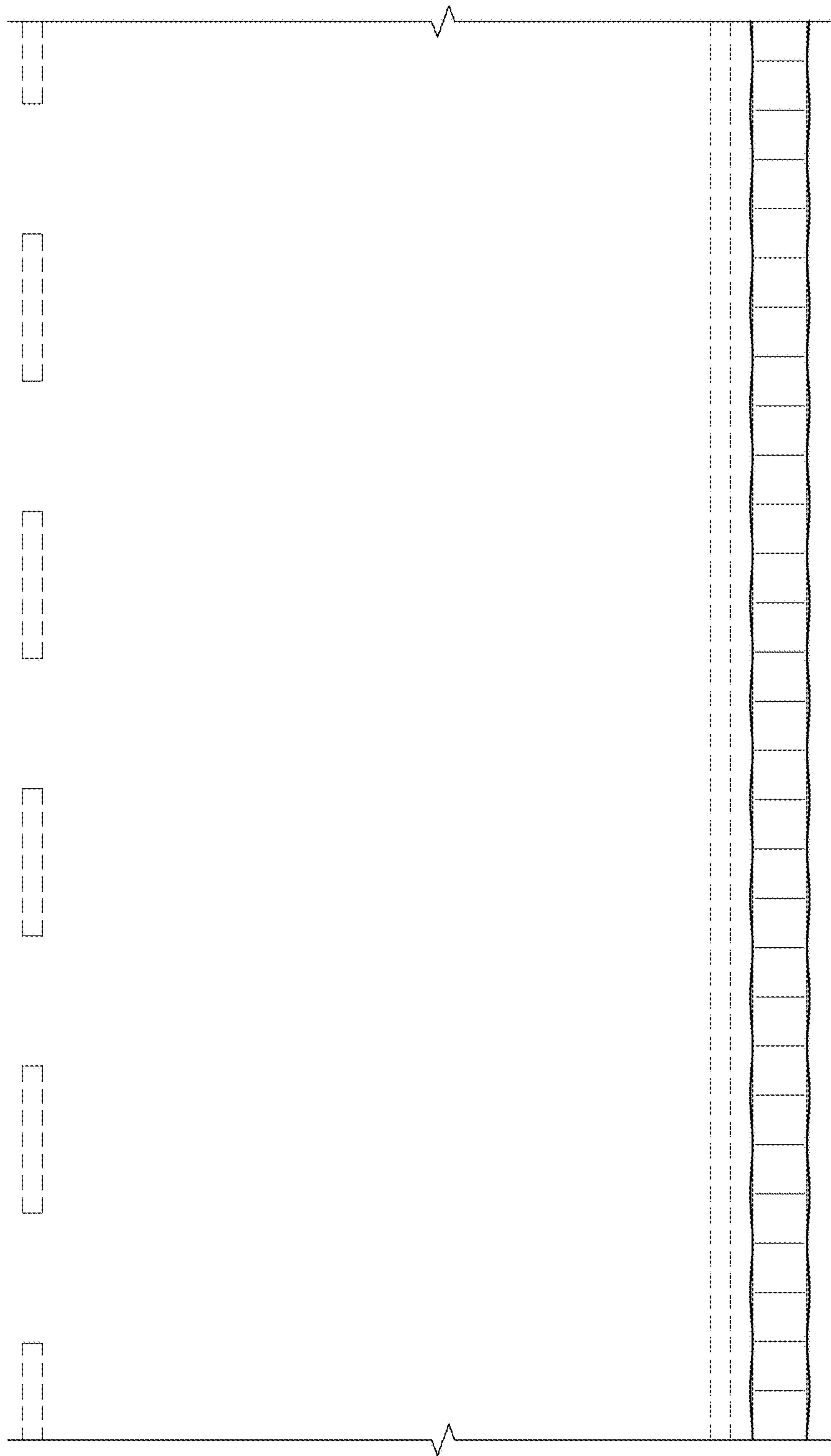

FIG. 22

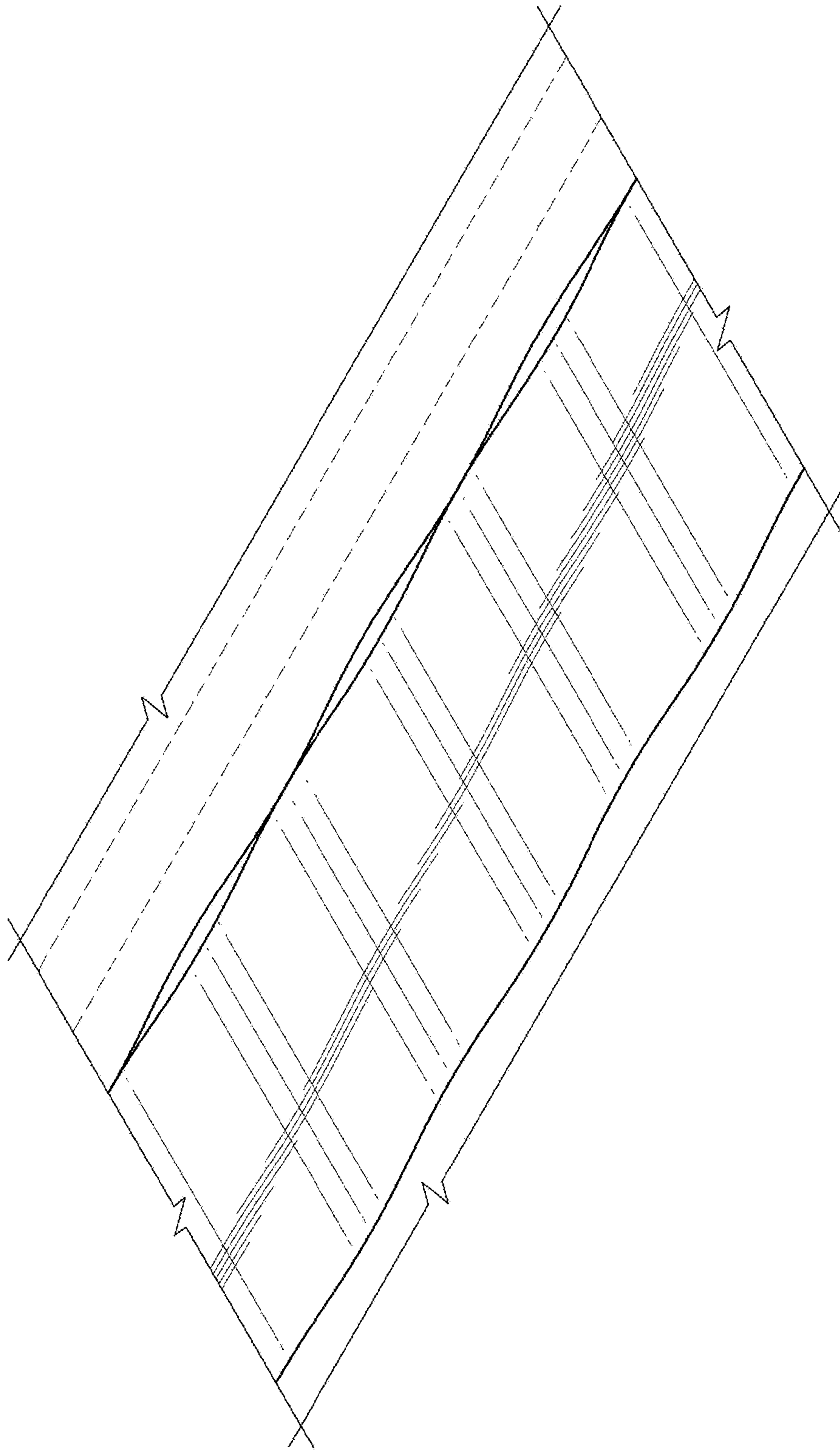

FIG. 23

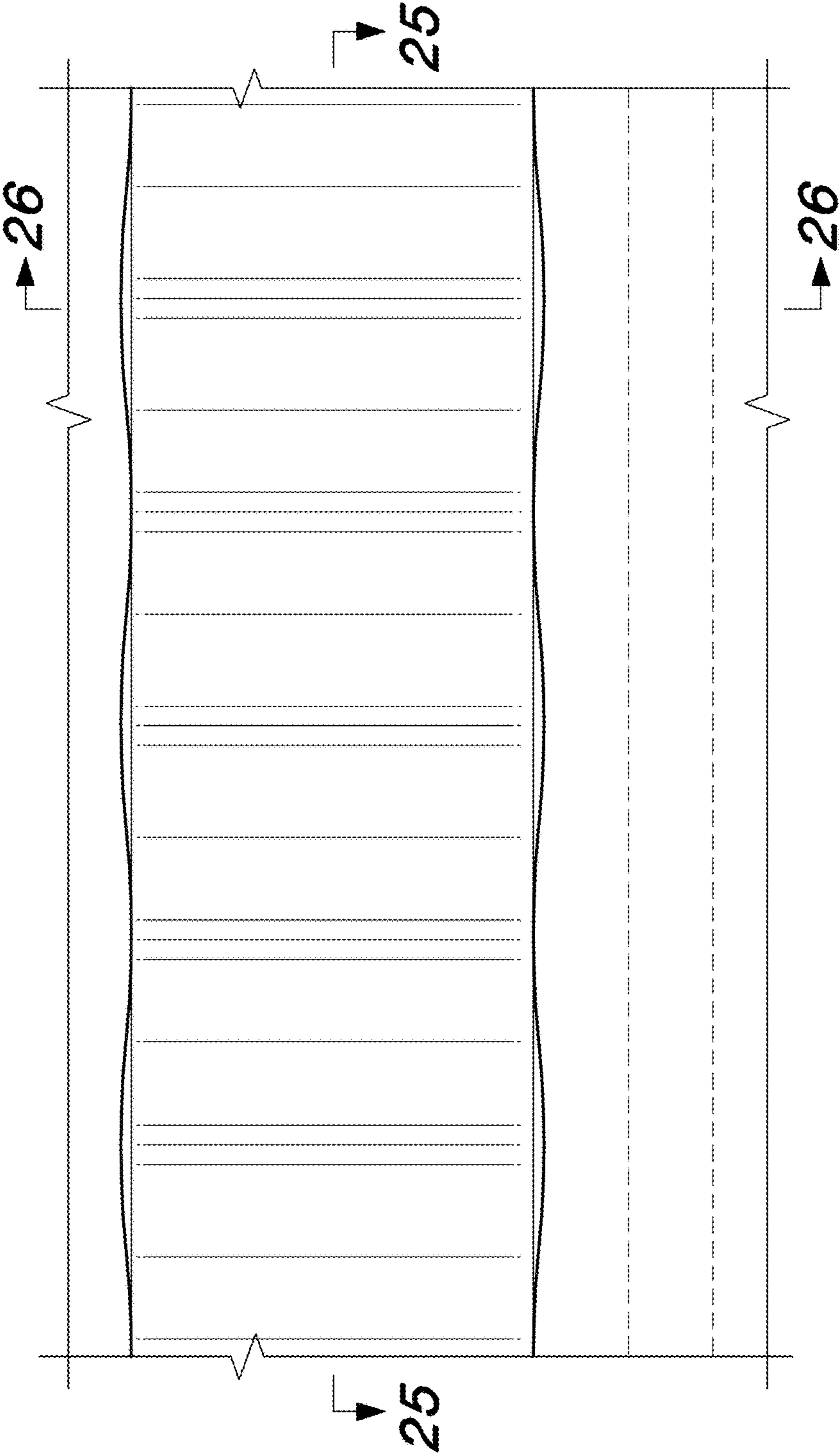

FIG. 24

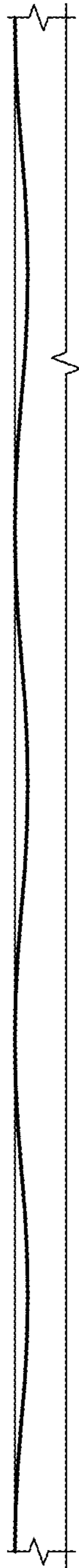

FIG. 25

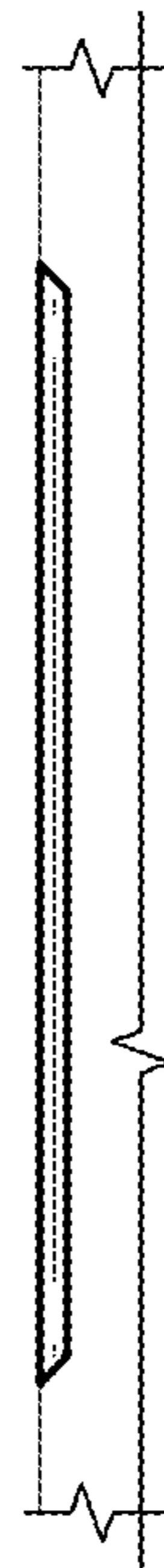

FIG. 26

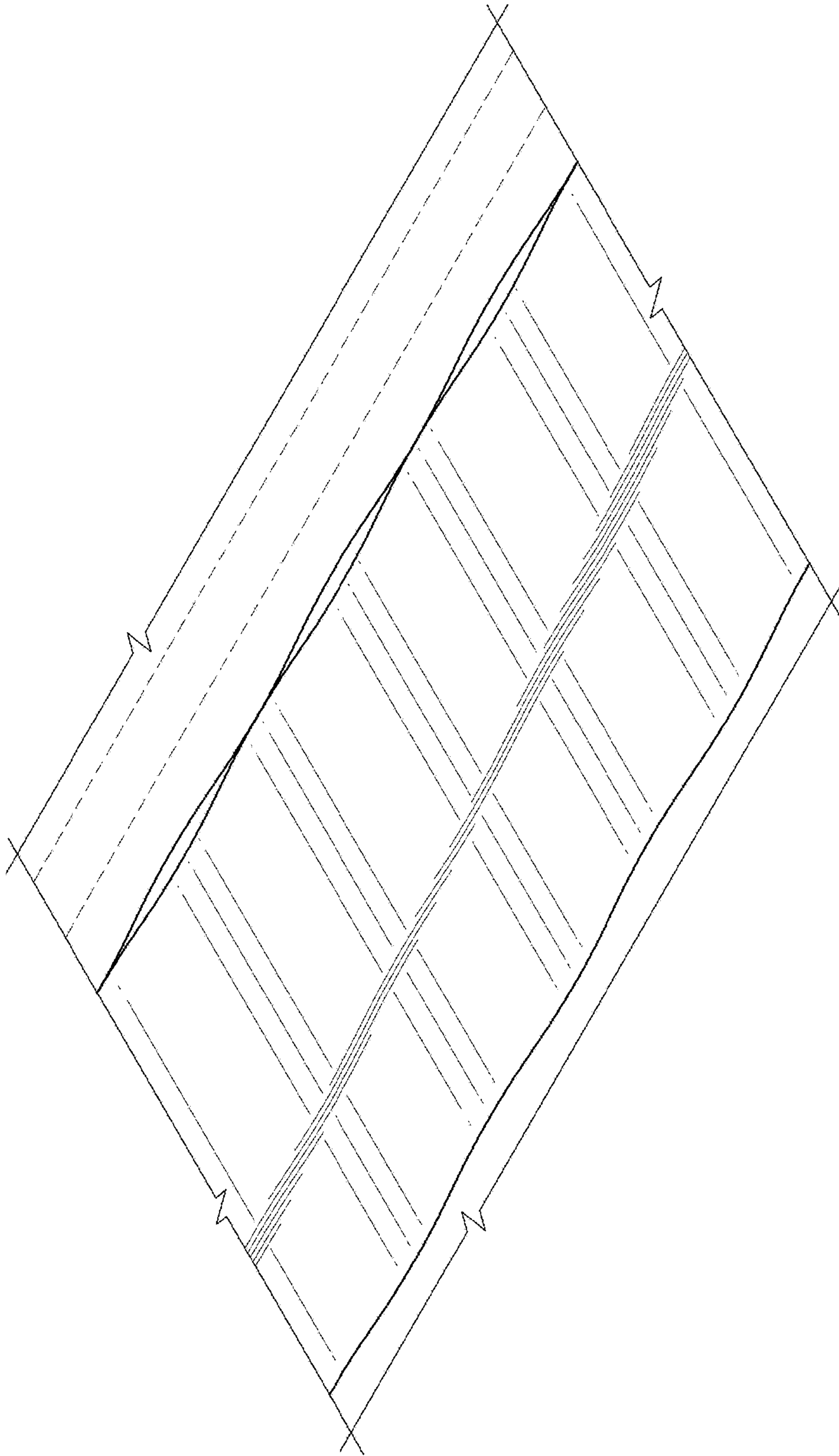

FIG. 27

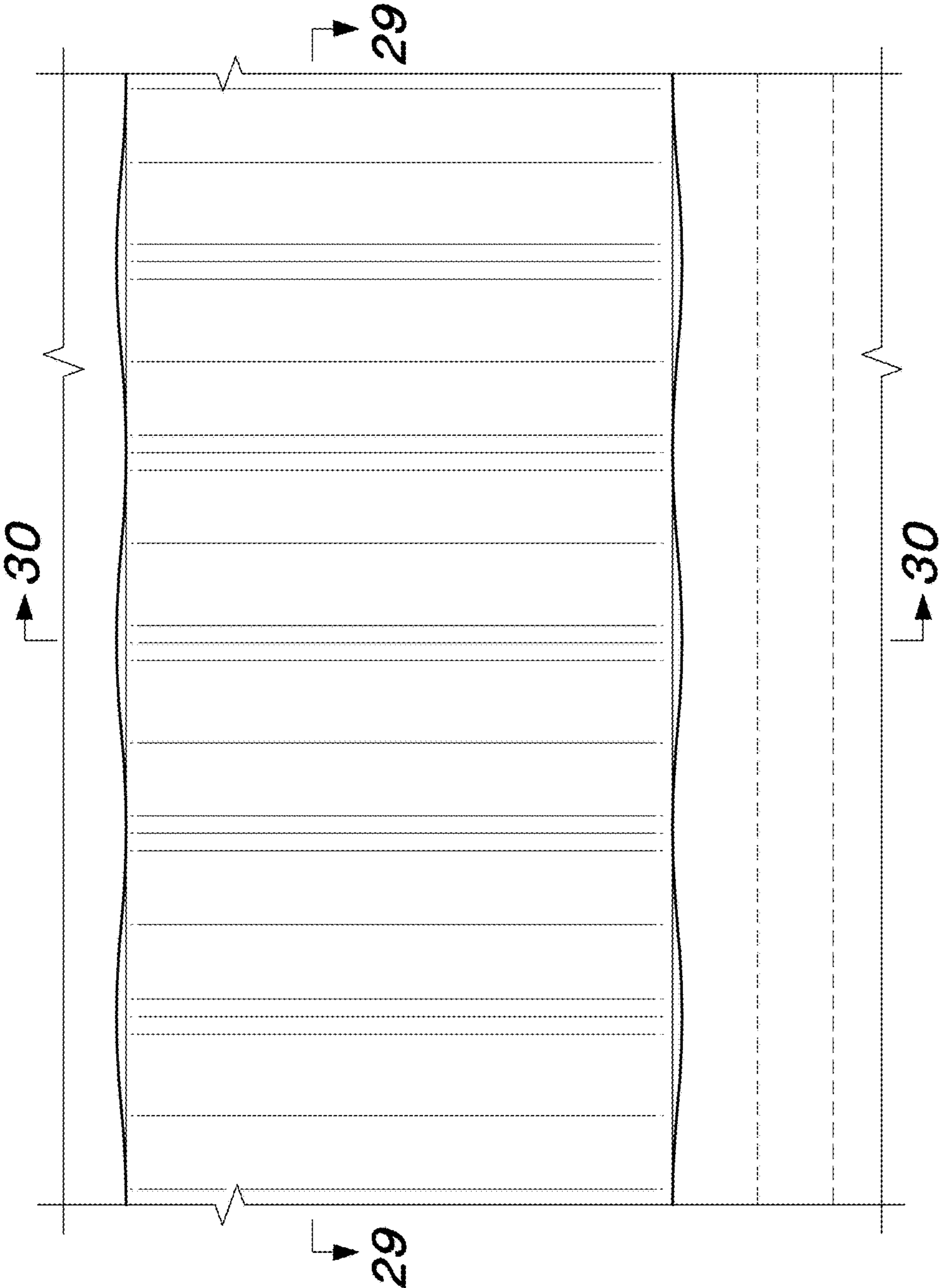

FIG. 28

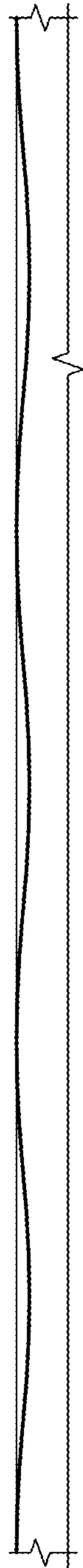

FIG. 29

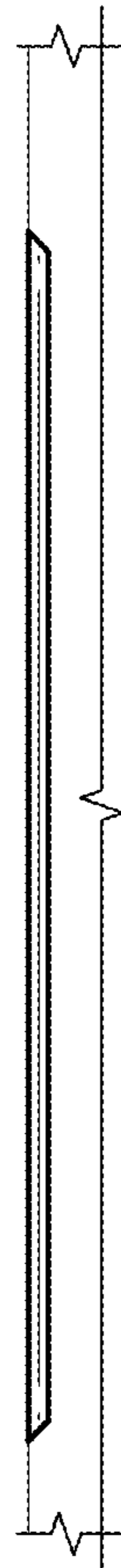

FIG. 30

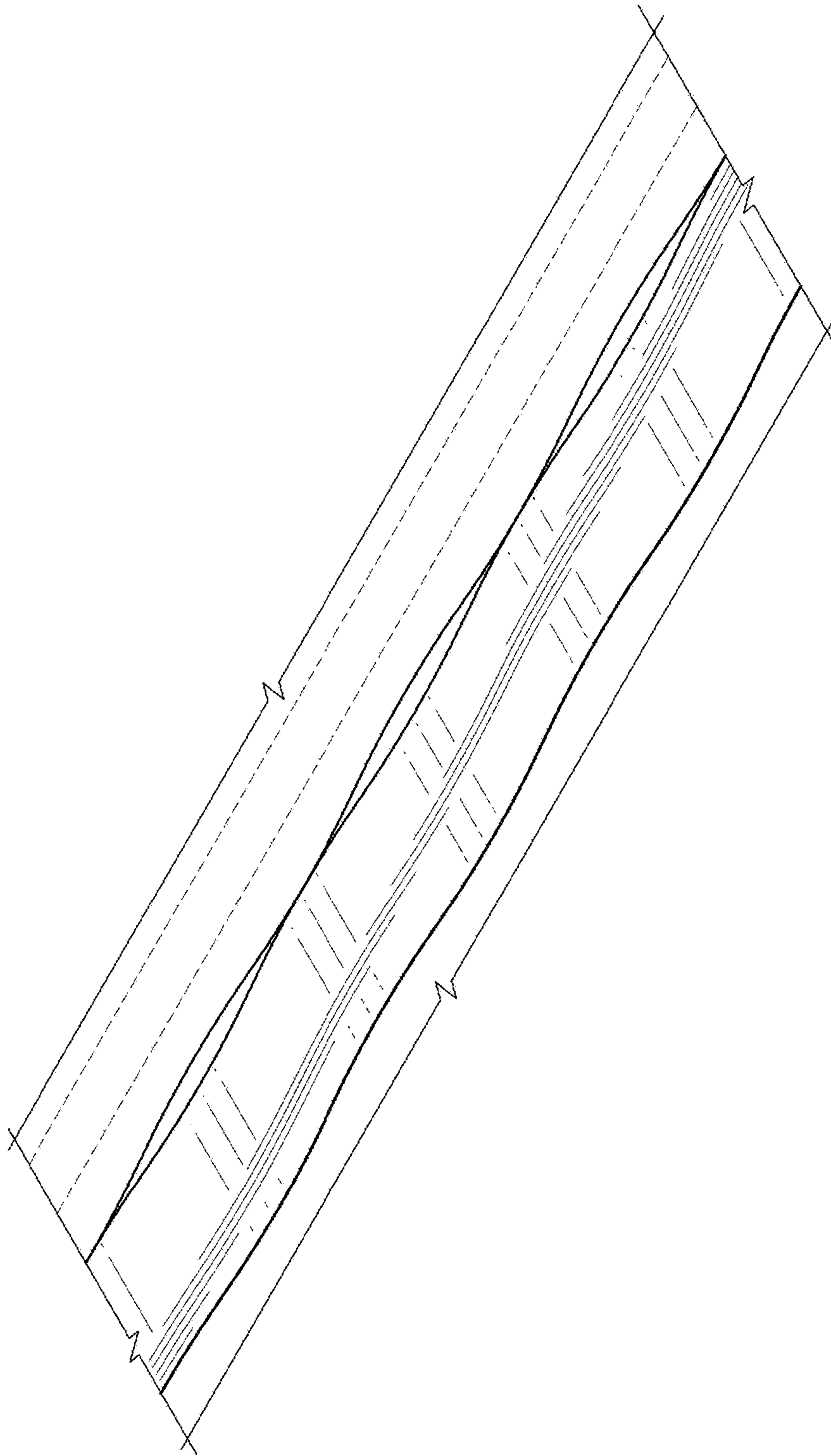

FIG. 31

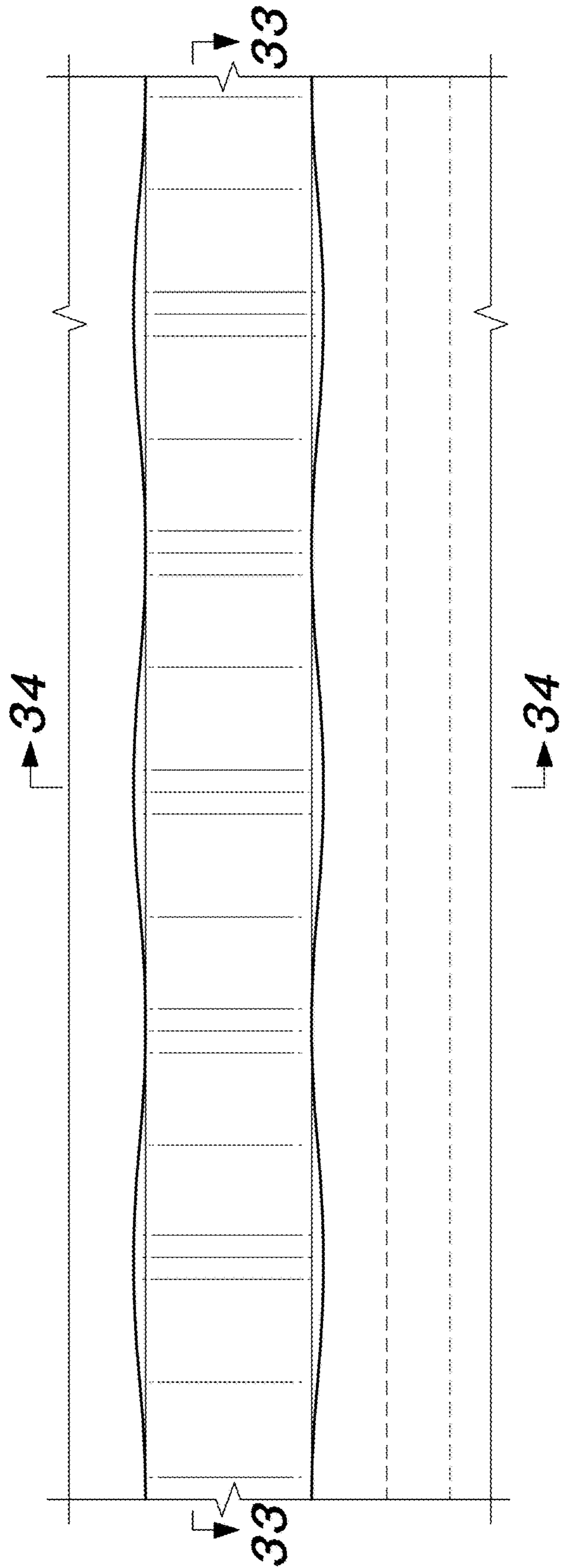

FIG. 32

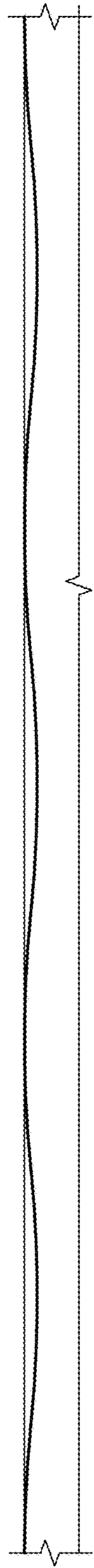

FIG. 33

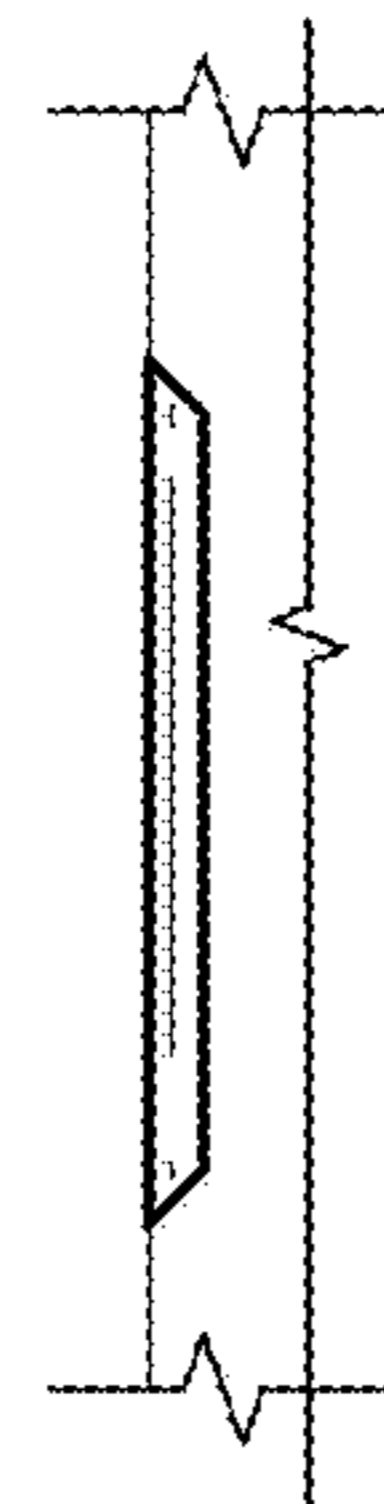

FIG. 34

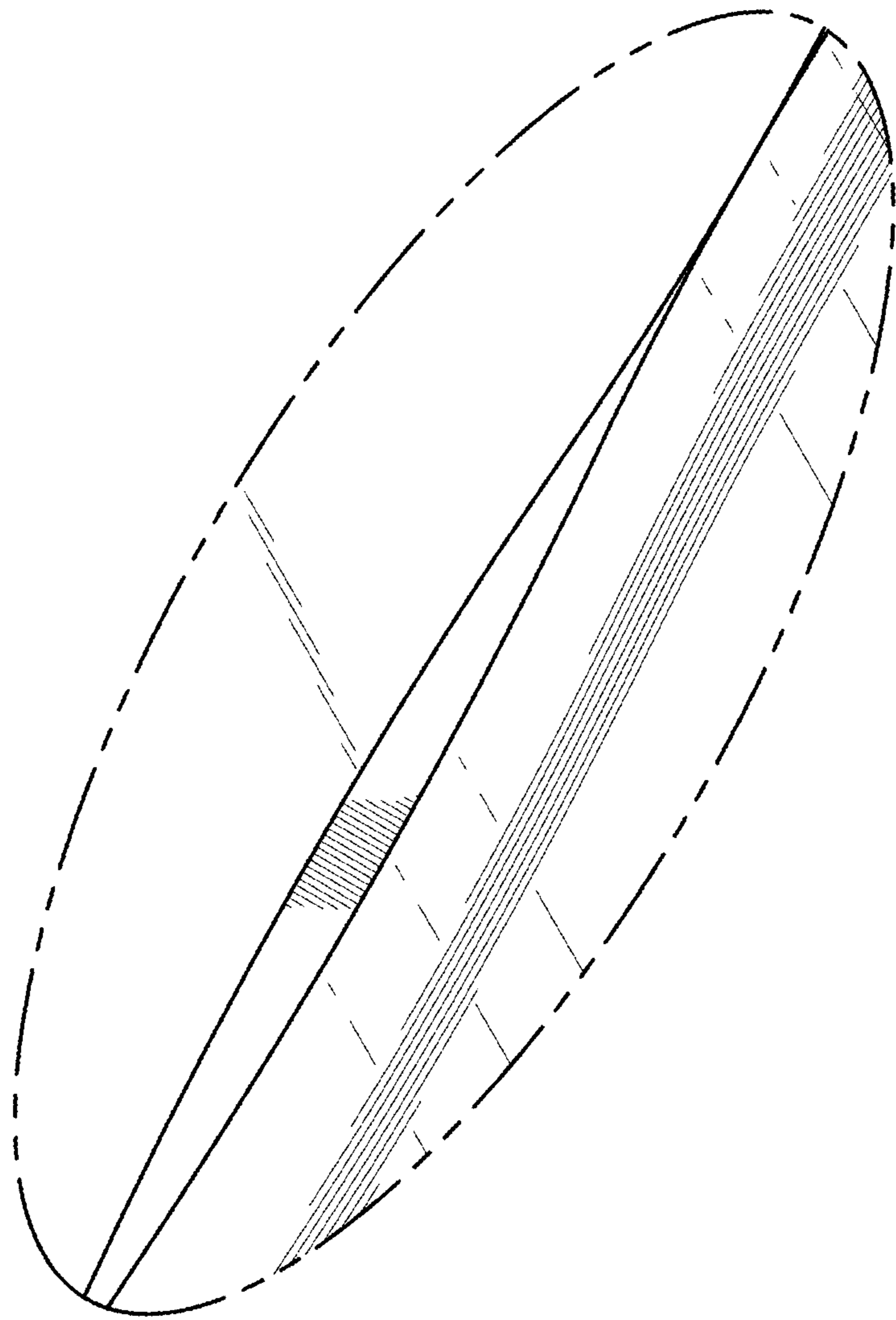
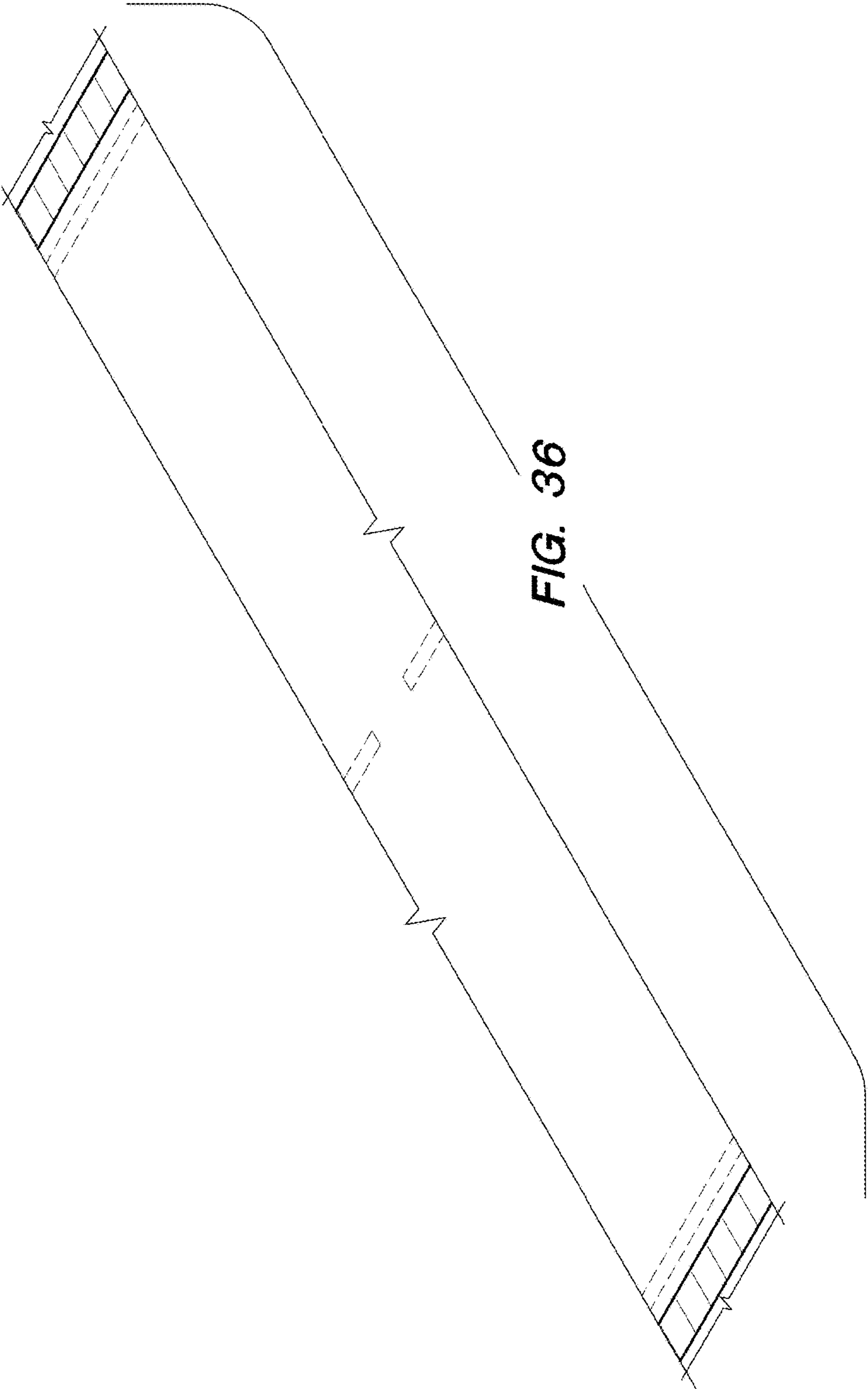

FIG. 35



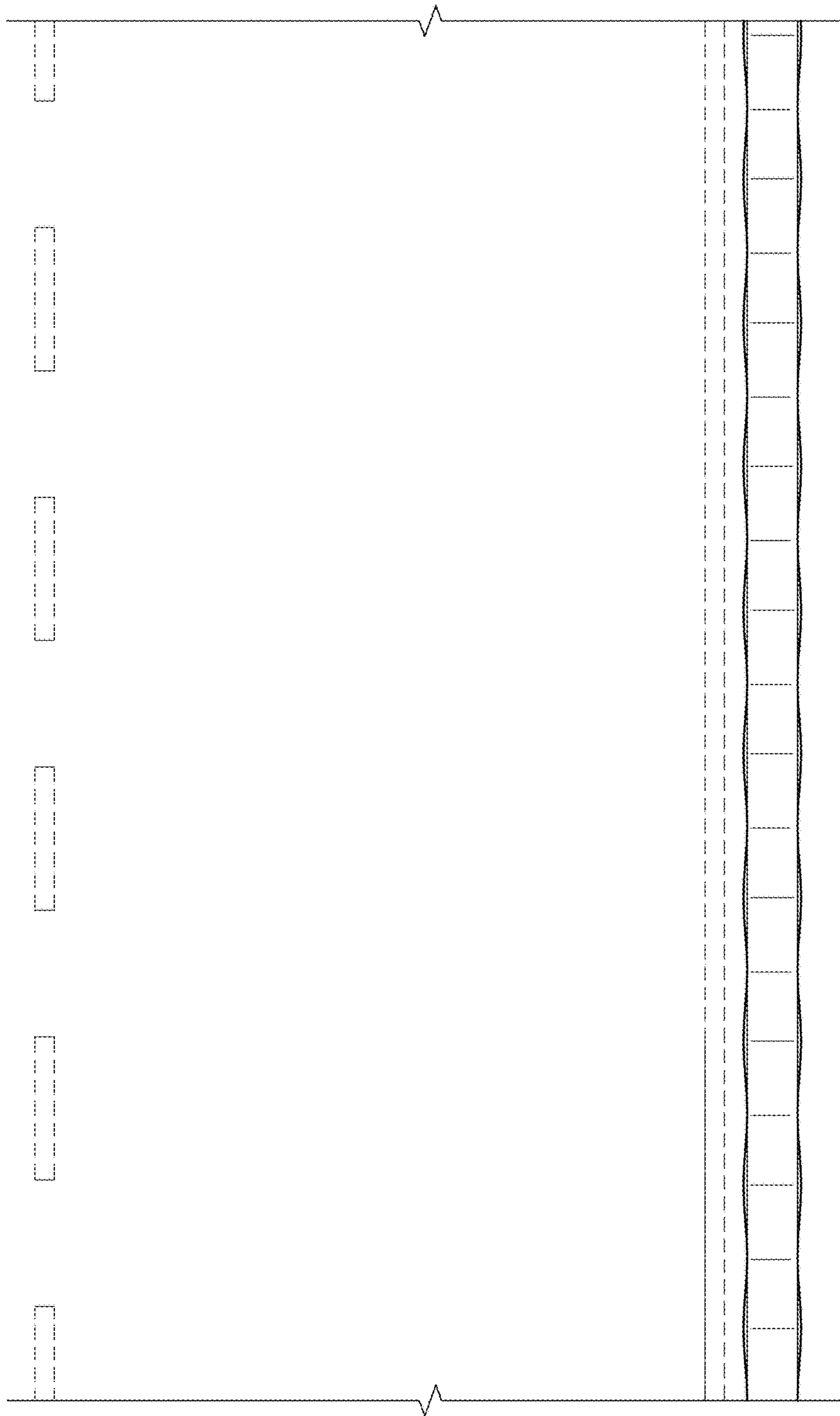

FIG. 37

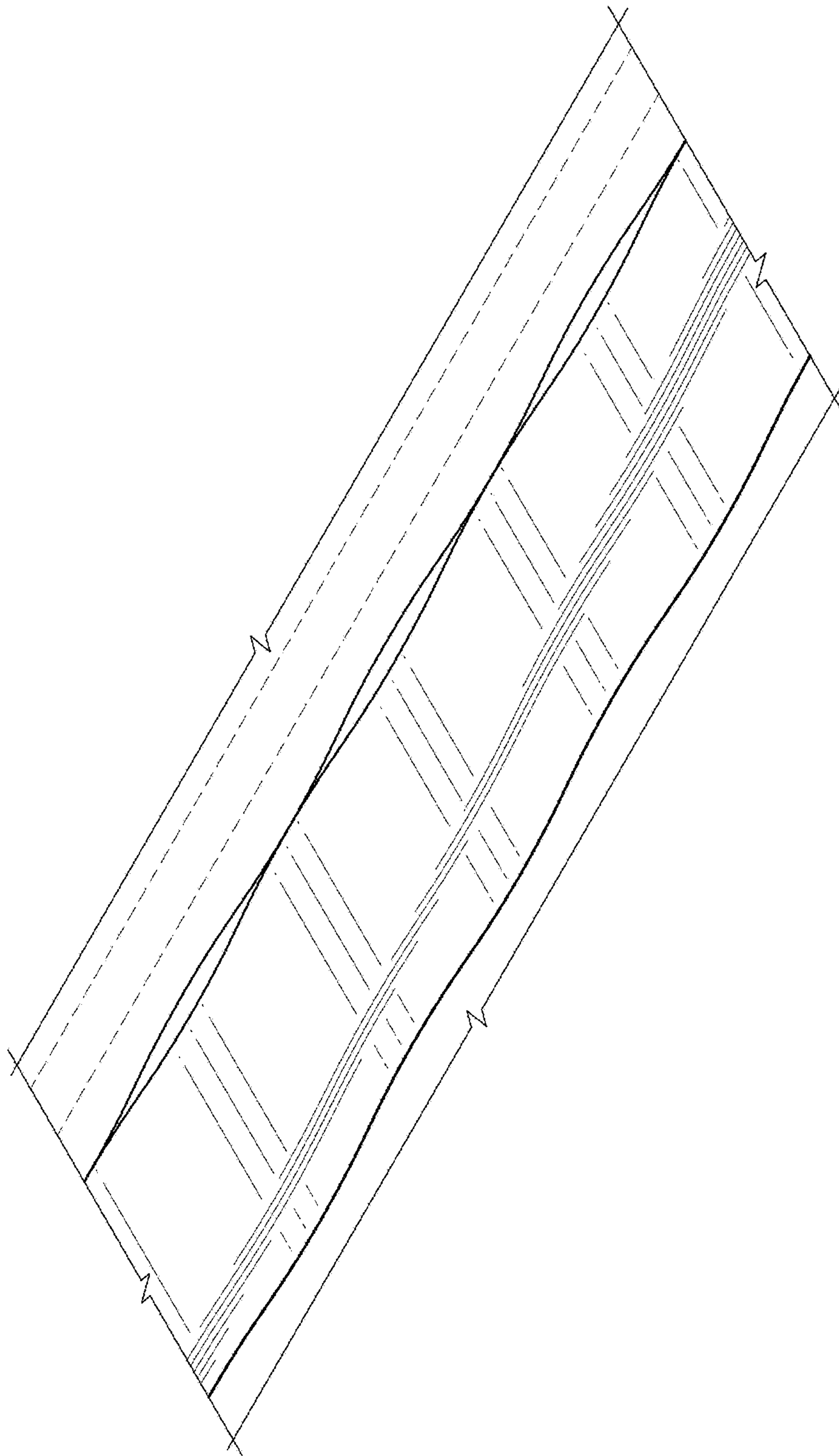

FIG. 38

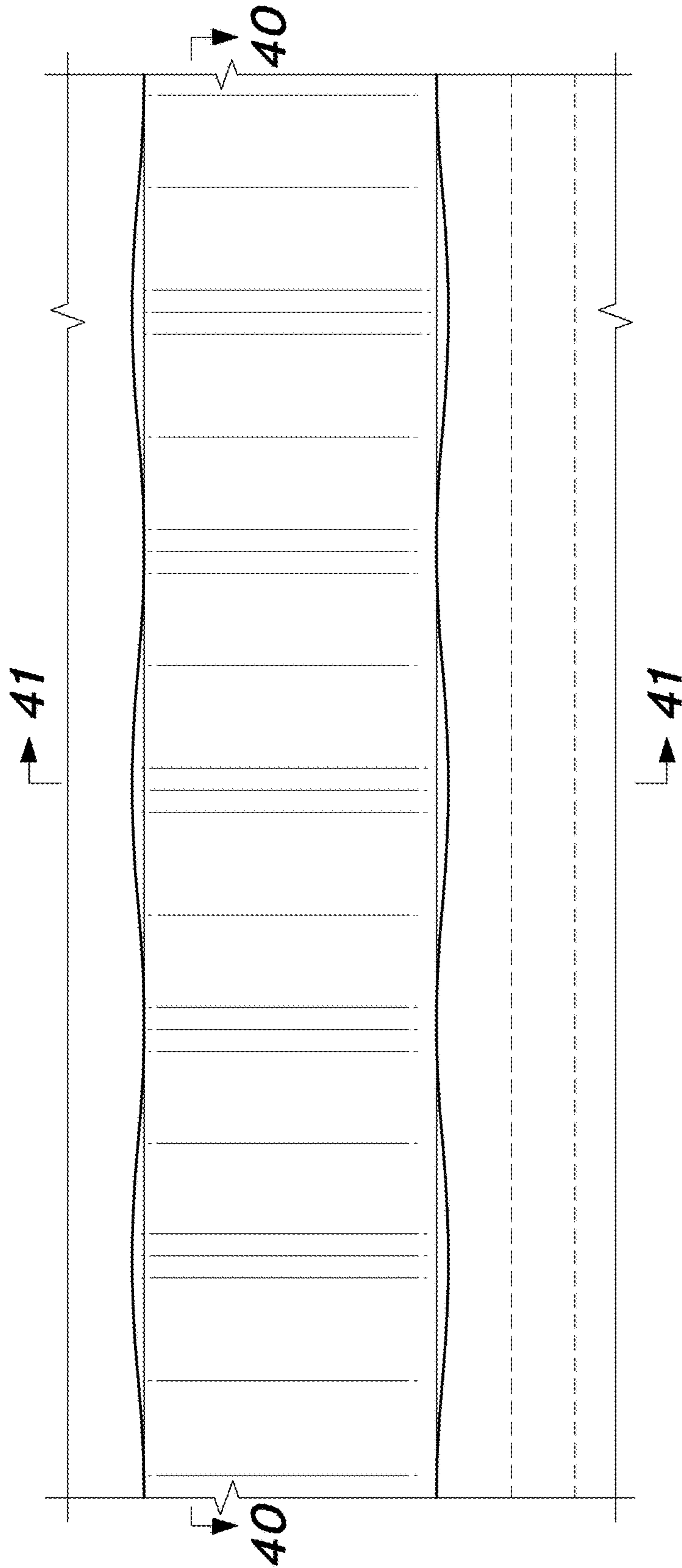

FIG. 39

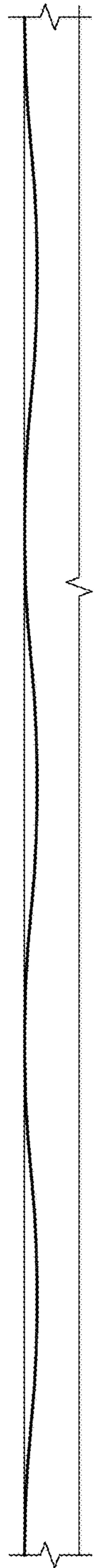

FIG. 40

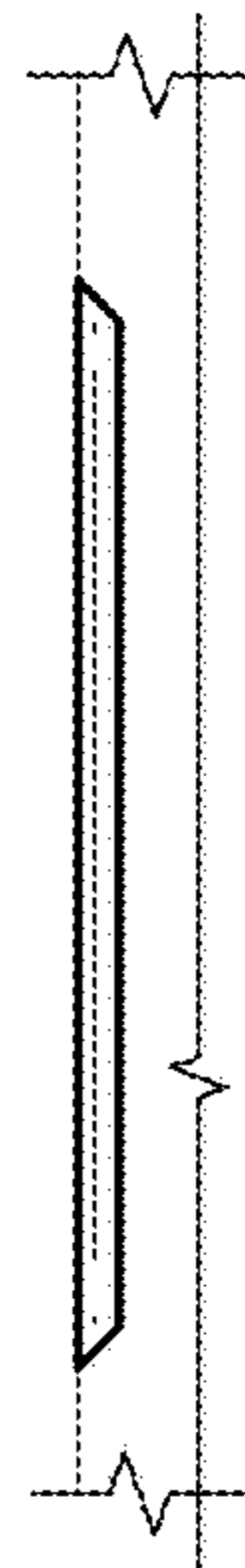

FIG. 41

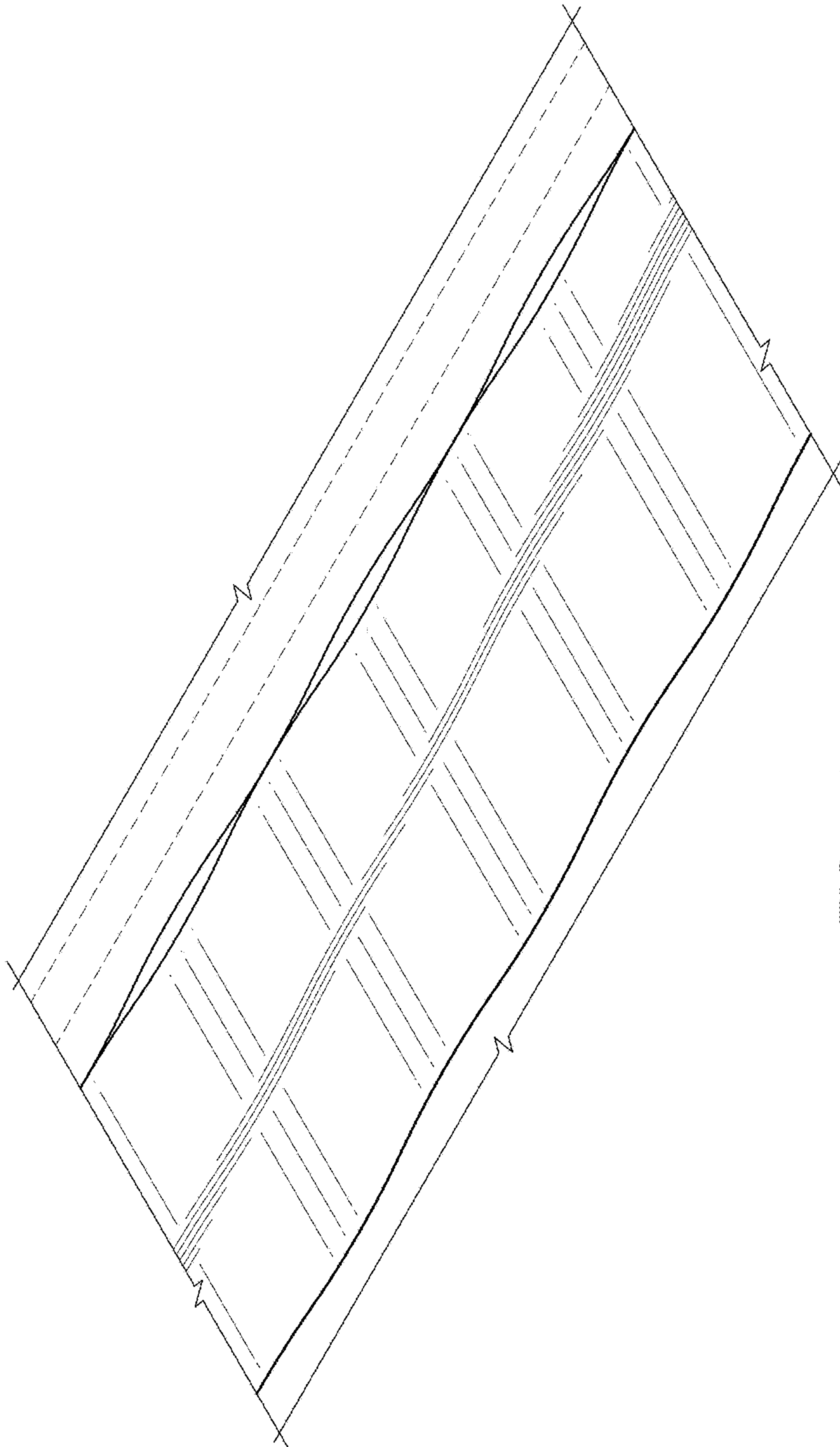

FIG. 42

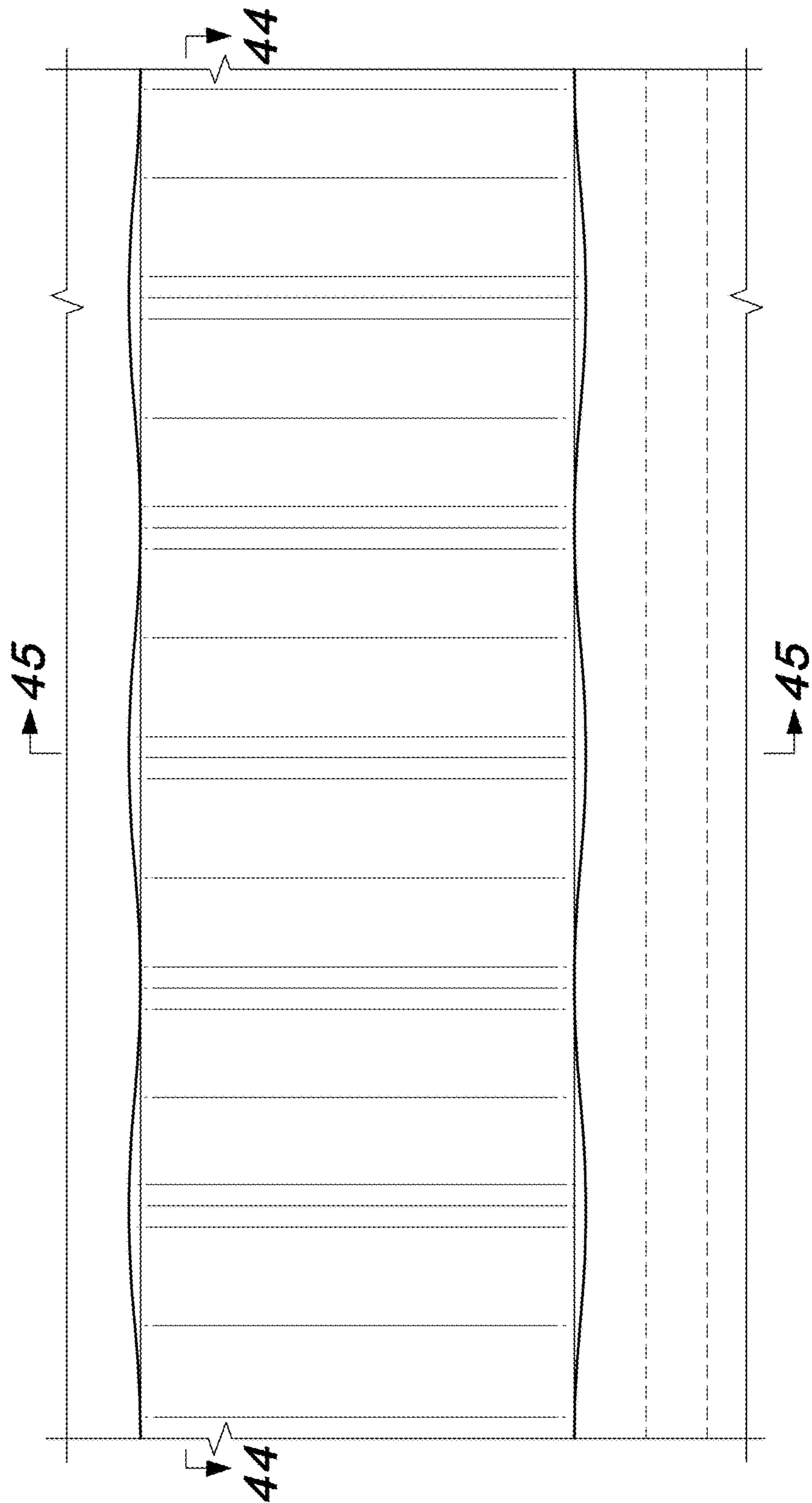

FIG. 43

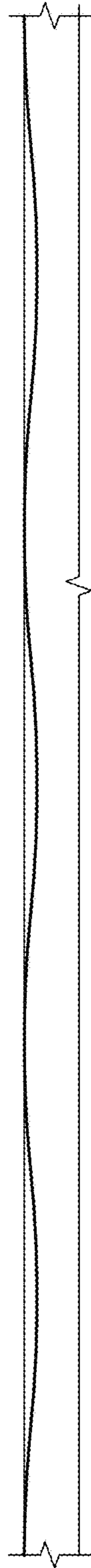

FIG. 44

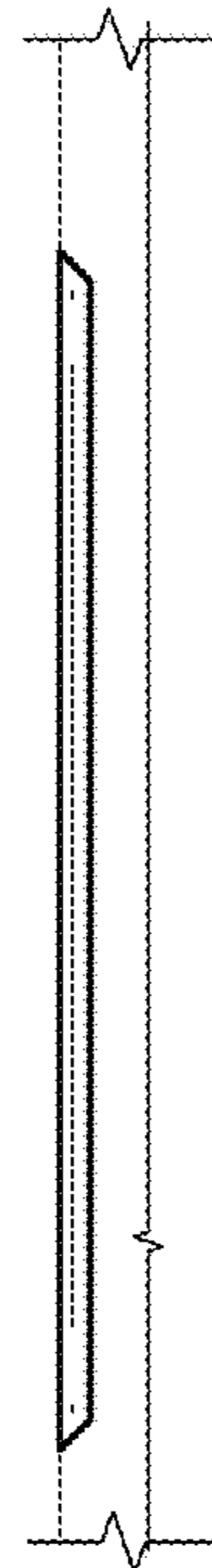

FIG. 45