



US00D774354S

(12) **United States Design Patent**
Scobey, Jr.

(10) **Patent No.:** **US D774,354 S**
(45) **Date of Patent:** **** Dec. 20, 2016**

- (54) **KNIFE COMFORT GRIP**
- (71) Applicant: **Fred Bradley Scobey, Jr.**, North Hollywood, CA (US)
- (72) Inventor: **Fred Bradley Scobey, Jr.**, North Hollywood, CA (US)
- (**) Term: **15 Years**
- (21) Appl. No.: **29/546,509**
- (22) Filed: **Nov. 23, 2015**
- (51) **LOC (10) Cl.** **07-03**
- (52) **U.S. Cl.**
USPC **D7/401.2; D7/649; D7/650**
- (58) **Field of Classification Search**
USPC D7/387, 393-395, 401.2, 642-652, 688, D7/693, 695-696; D8/91, 93, 97-100, D8/107, 300, 321; D22/117-118
CPC A01B 1/20; A01B 1/22; A22C 25/006; A22C 25/025; A47G 21/06; A47G 21/065; A47J 17/02; A61B 17/3211; A61B 17/3213; B21D 53/64; B25G 3/36; B26B 1/00; B26B 1/08; B26B 1/10; B26B 3/00; B26B 3/02; B26B 3/03; B26B 3/04; B26B 3/06; B26B 5/00; B26B 5/001; B26B 5/007; B26B 7/00; B26B 7/005; B26B 9/00; B26B 9/02; B26B 11/00; B26B 11/006; B26B 17/00; B26B 17/006; B26B 29/02; B67B 7/24
See application file for complete search history.

- (56) **References Cited**
U.S. PATENT DOCUMENTS
492,409 A * 2/1893 May B26B 29/02 30/295
649,059 A * 5/1900 Kern B26B 29/02 30/295
673,506 A * 5/1901 Pitts B67B 7/24 15/143.1

- 1,750,577 A * 3/1930 De Bracht A47J 17/02 30/295
- 2,569,022 A * 9/1951 Sagers A22C 25/025 119/631
- D397,282 S * 8/1998 Derkatz D8/107
- D445,643 S * 7/2001 Kazaklaris D7/401.2
- D539,086 S * 3/2007 Aston, III D7/401.2
- 7,434,320 B2 * 10/2008 Aston, III B26B 29/02 30/295
- D610,399 S * 2/2010 Hamlin D7/387
- D643,261 S * 8/2011 Spiegel D7/649
- D719,405 S * 12/2014 Miller D7/401.2
- 8,931,381 B2 * 1/2015 Poran B26B 29/02 30/1

* cited by examiner

Primary Examiner — Ricky Pham
(74) *Attorney, Agent, or Firm* — Colin P. Abrahams

(57) **CLAIM**
The ornamental design for a knife comfort grip, as shown and described.

DESCRIPTION
FIG. 1 is a perspective view of a knife comfort grip in accordance with the invention;
FIG. 2 is an inside view of the knife comfort grip as illustrated in FIG. 1 of the drawings;
FIG. 3 is an outside view of the knife comfort grip as illustrated in FIG. 1 of the drawings;
FIG. 4 is a left side view of the knife comfort grip as illustrated in FIG. 1 of the drawings;
FIG. 5 is a right side view of the knife comfort grip as illustrated in FIG. 1 of the drawings;
FIG. 6 is a bottom view of the knife comfort grip as illustrated in FIG. 1 of the drawings;
FIG. 7 is a top view of a knife comfort grip as illustrated in FIG. 1 of the drawings; and,
FIG. 8 is a perspective view of the knife comfort grip mounted on a knife.
The broken lines shown in the drawings are for illustrative purposes only and form no part of the claimed design.

1 Claim, 4 Drawing Sheets

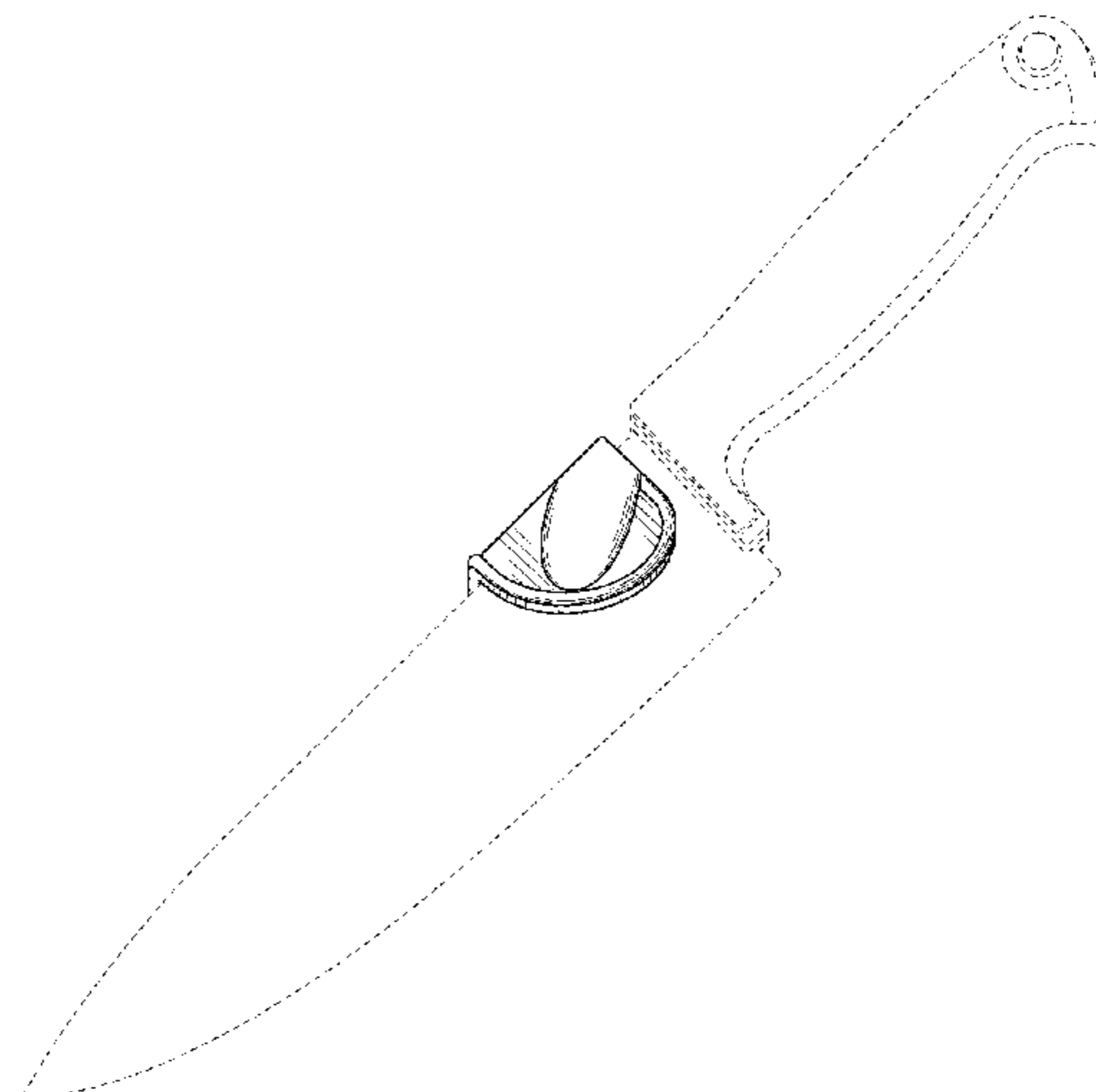
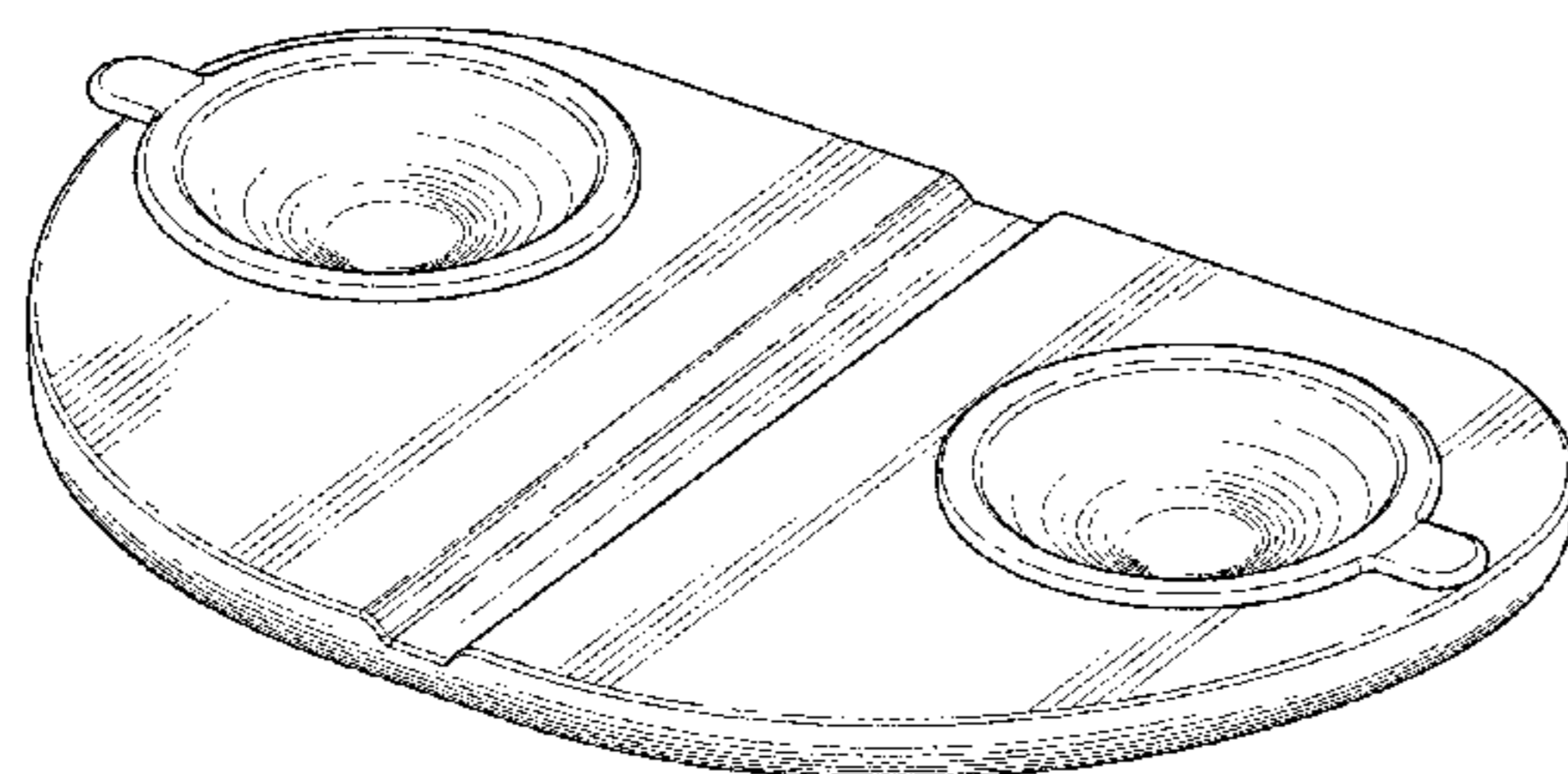

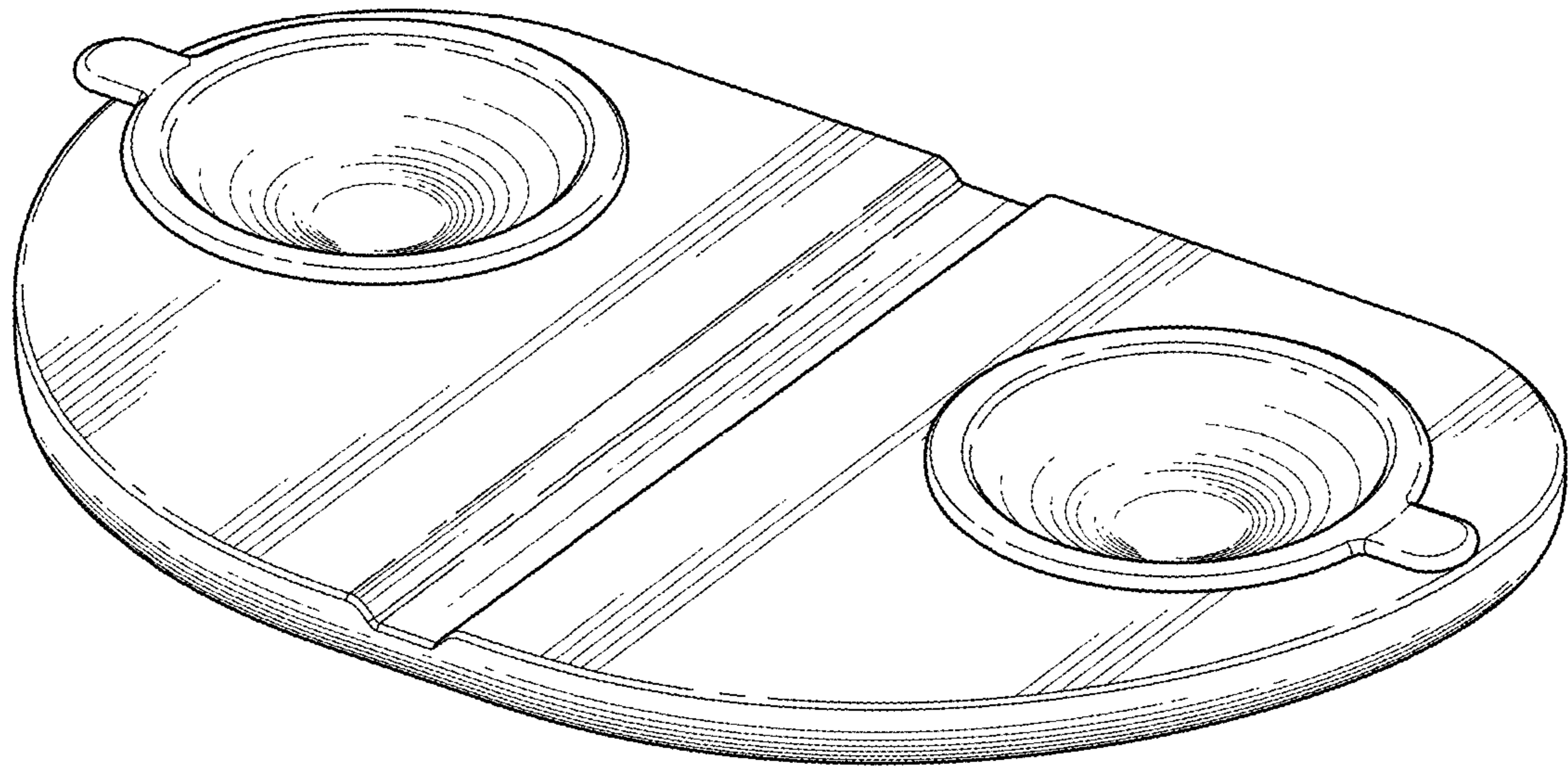

FIG. 1

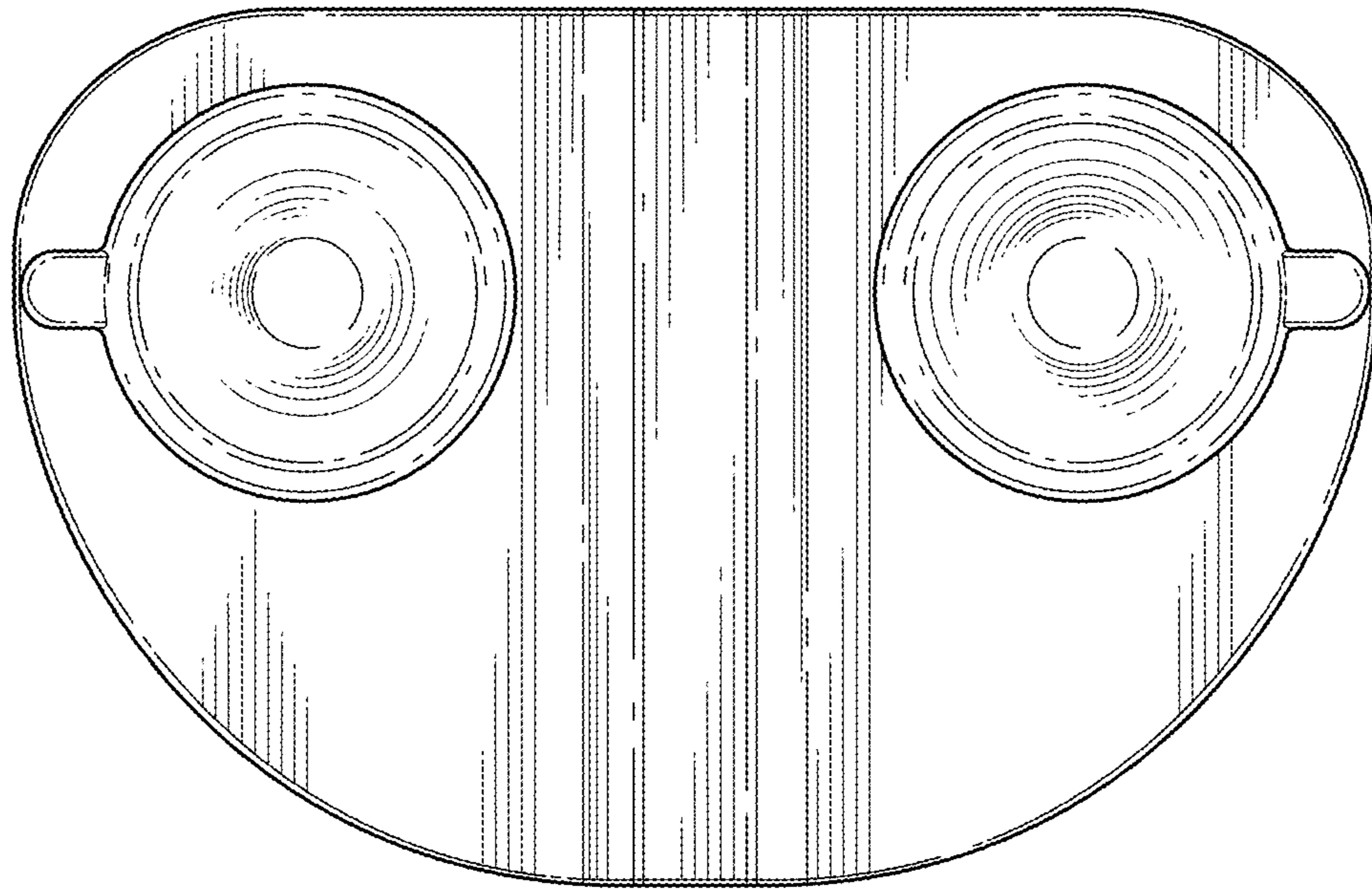

FIG. 2

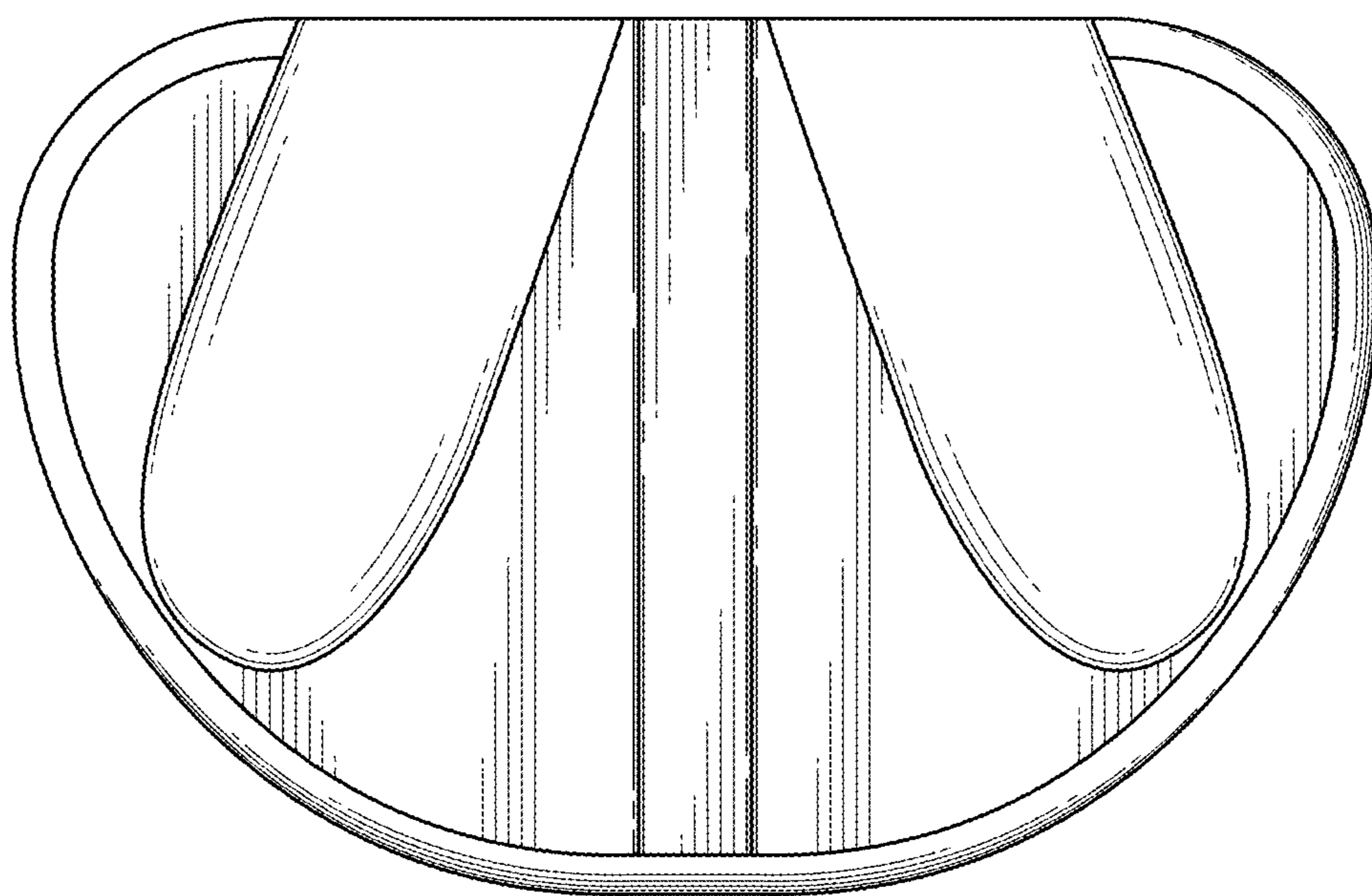

FIG. 3

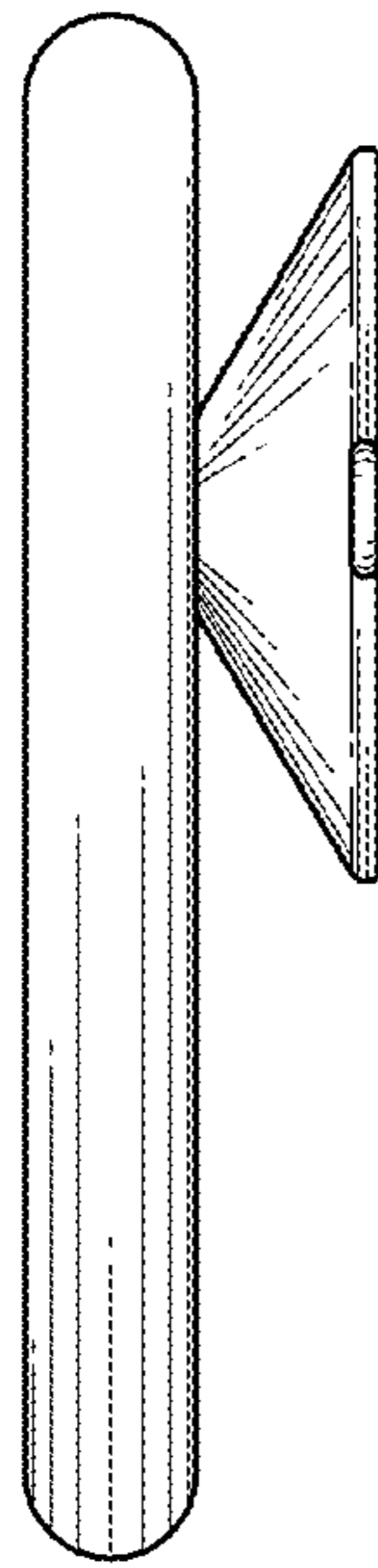

FIG. 4

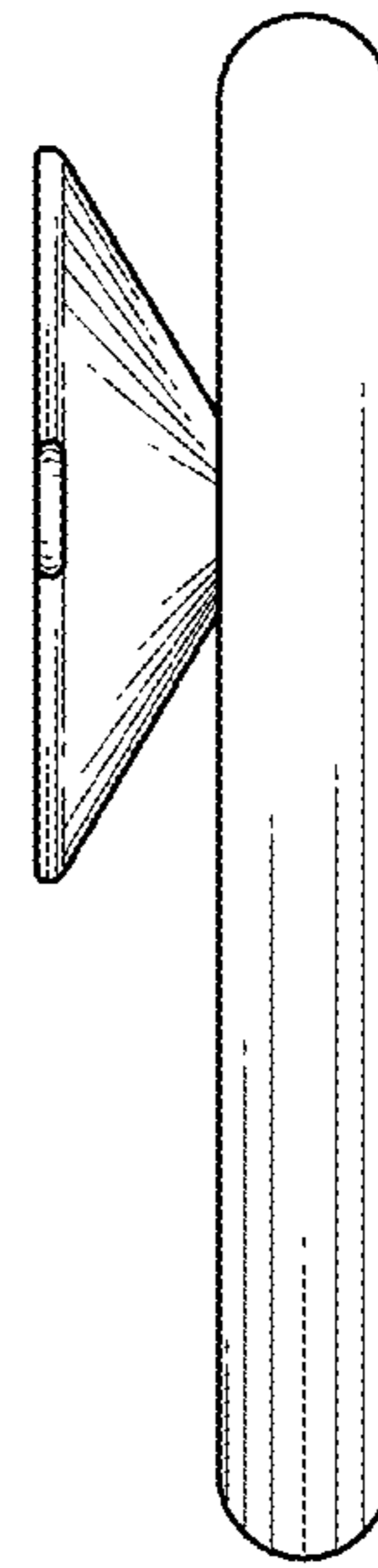

FIG. 5

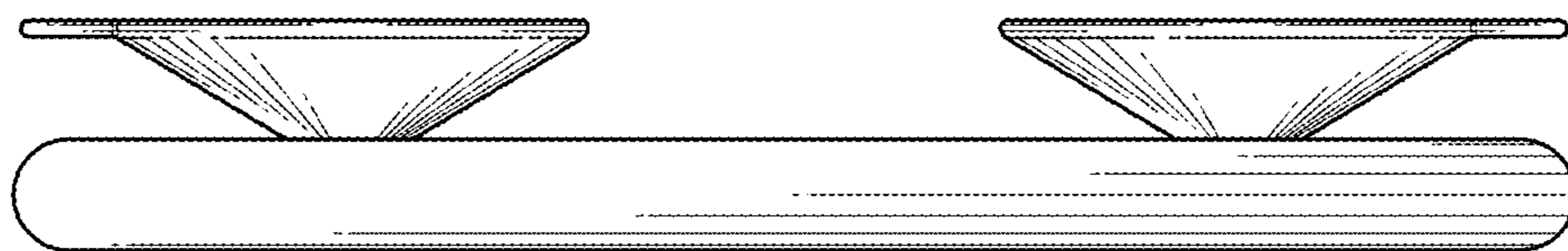

FIG. 6

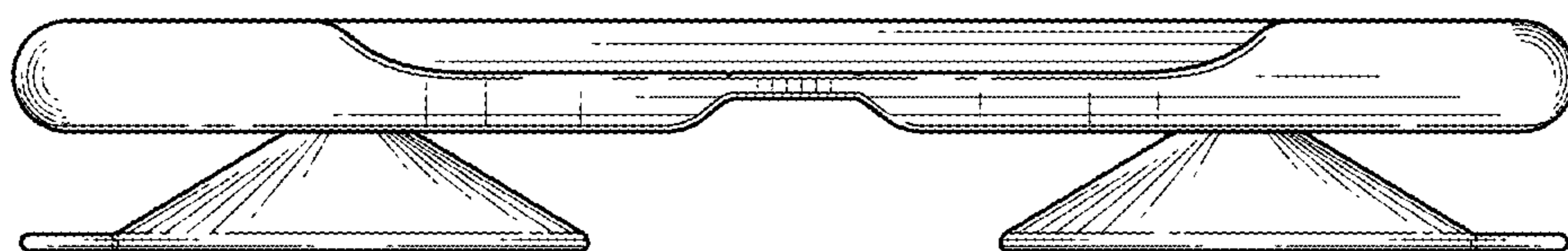

FIG. 7

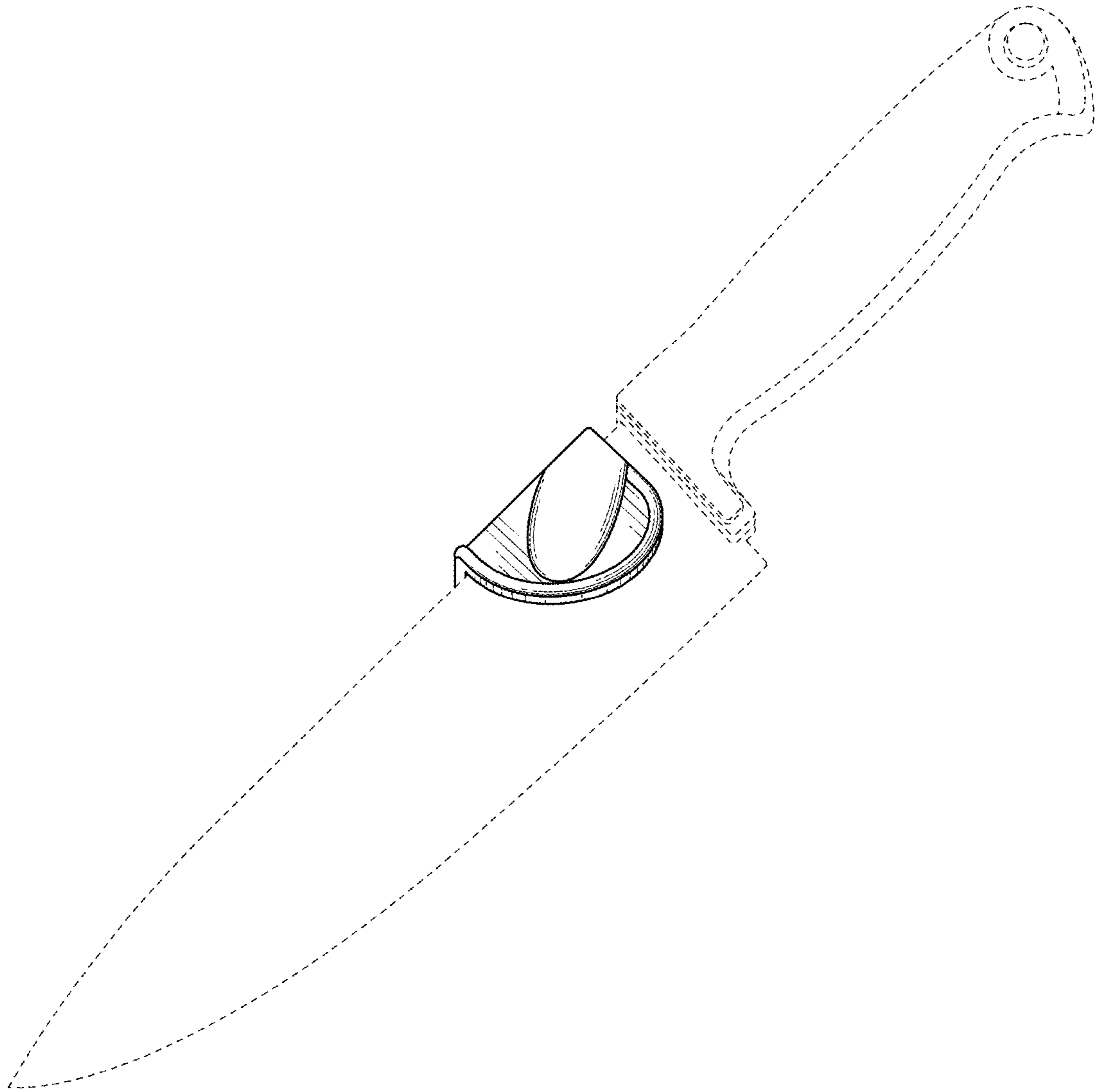

FIG. 8