



US00D774321S

(12) **United States Design Patent** (10) **Patent No.:** **US D774,321 S**
Webb (45) **Date of Patent:** **** Dec. 20, 2016**

- (54) **FURNITURE MODULE**
- (71) Applicant: **Roger Webb Associates Ltd.**, London (GB)
- (72) Inventor: **Roger Webb**, London (GB)
- (73) Assignee: **ROGER WEBB ASSOCIATES LTD.**, London (GB)
- (**) Term: **15 Years**
- (21) Appl. No.: **29/559,431**
- (22) Filed: **Mar. 28, 2016**

Related U.S. Application Data

- (60) Continuation of application No. 29/540,339, filed on Sep. 23, 2015, now abandoned, which is a division of (Continued)
- (51) **LOC (10) Cl.** **06-01**
- (52) **U.S. Cl.**
USPC **D6/381**
- (58) **Field of Classification Search**
USPC D6/334-338, 349, 355, 361, 368-370, D6/376, 379-381, 716, 716.1, 716.2, 340, D6/354, 377; 297/16.1, 42, 94, 135, 175, 297/232, 233, 350, 351, 445.1, 448.1, 297/448.2, 451.9; 5/12.1, 12.2; D21/809 (Continued)

References Cited

U.S. PATENT DOCUMENTS

- D132,793 S * 6/1942 Reiss D6/364
 - D239,671 S * 4/1976 Offredi D6/371
- (Continued)

Primary Examiner — Sandra Snapp

(74) *Attorney, Agent, or Firm* — Abelman, Frayne & Schwab

(57) **CLAIM**

The ornamental design for furniture module, as shown and described.

DESCRIPTION

FIG. 1 is a front elevation view of furniture module showing my new design,
 FIG. 2 is a left side elevation thereof, the right side elevation view is a mirror image of the left side elevation view,
 FIG. 3 is a rear elevation view thereof,
 FIG. 4 is a top plan view thereof,
 FIG. 5 is a top, front, and right side perspective view thereof,
 FIG. 6 is a top, rear, and left side perspective view thereof,
 FIG. 7 is a front elevation view of furniture module, according to another embodiment of the present invention,
 FIG. 8 is a left side elevation view thereof, the right side elevation view is a mirror image thereof,
 FIG. 9 is a rear elevation view thereof,
 FIG. 10 is a top plan view thereof,
 FIG. 11 is a top, front, and right side perspective view thereof,
 FIG. 12 is a top, front, and left side perspective view thereof,
 FIG. 13 is a front elevation view of furniture modules, according to another embodiment of the present invention,
 FIG. 14 is a left side elevation view thereof, the right side elevation view is a mirror image of the left side elevation view,
 FIG. 15 is a rear elevation view thereof,
 FIG. 16 is a top plan view thereof,
 FIG. 17 is a top, front, and right side perspective view thereof; and,
 FIG. 18 is a top, rear, and left side perspective view thereof.
 In all the above figures the bottom view is not shown and is not claimed.

1 Claim, 18 Drawing Sheets

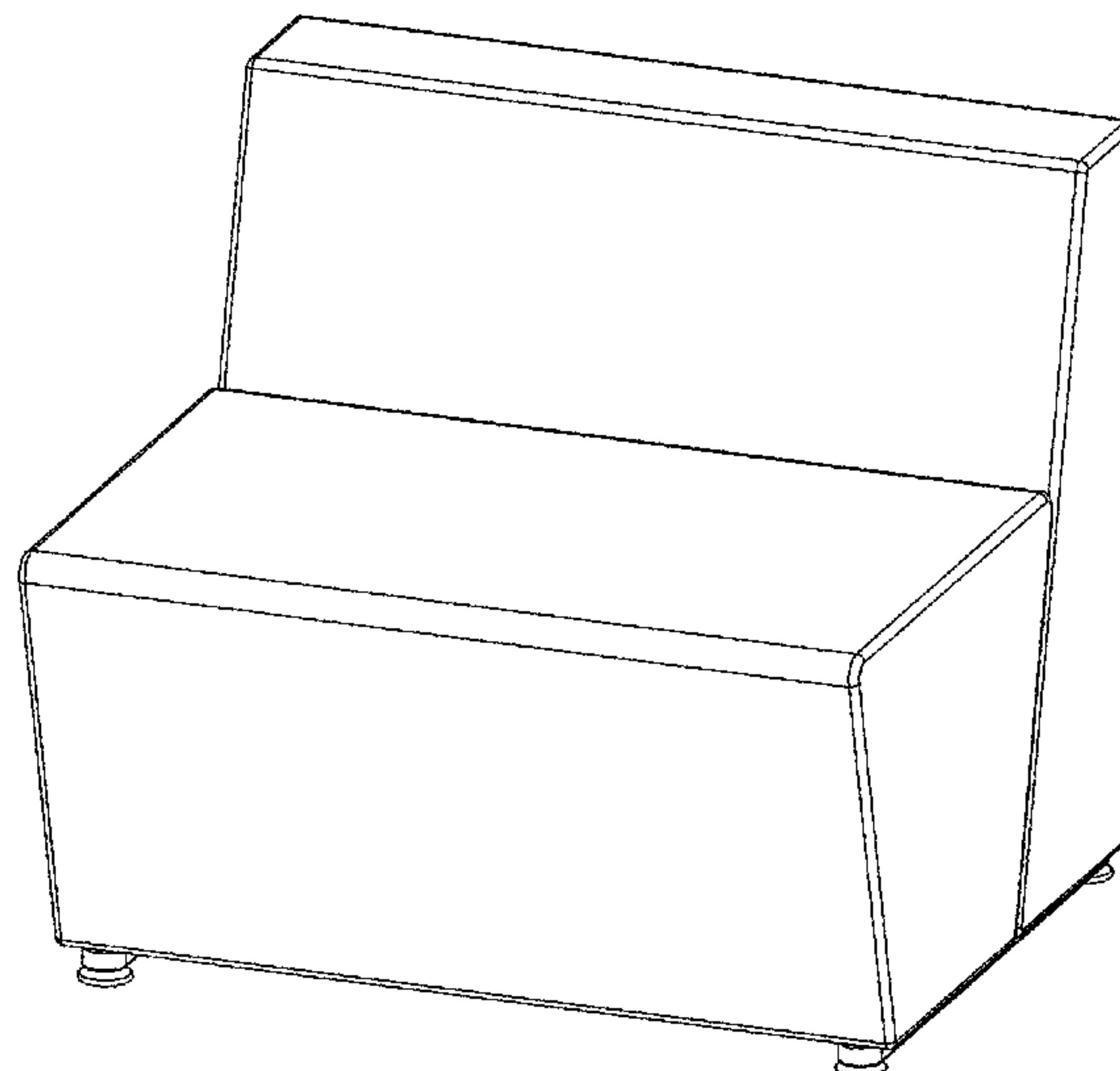

Related U.S. Application Data

application No. 29/475,308, filed on Dec. 2, 2013,
now Pat. No. Des. 739,662.

(58) **Field of Classification Search**

CPC A47C 1/12; A47C 11/00; A47C 17/00;
A47C 17/02

See application file for complete search history.

(56) **References Cited**

U.S. PATENT DOCUMENTS

D244,894 S * 7/1977 Tillberg D6/381
D261,953 S * 11/1981 Aronowitz D6/363
D261,954 S * 11/1981 Aronowitz D6/363
D261,955 S * 11/1981 Aronowitz D6/363
D262,163 S * 12/1981 Aronowitz D6/364
D262,164 S * 12/1981 Aronowitz D6/364
D262,166 S * 12/1981 Aronowitz D6/378
D262,421 S * 12/1981 Aronowitz D6/364

D264,027 S * 4/1982 Aronowitz D6/364
D284,142 S * 6/1986 Raftery D6/334
D336,377 S * 6/1993 Gibson D6/334
D384,827 S * 10/1997 Hutton D6/334
D433,825 S * 11/2000 Piretti D6/334
D545,070 S * 6/2007 Hutton D6/334
7,287,816 B1 * 10/2007 Karl A47C 31/113
297/452.11
D577,211 S * 9/2008 Natuzzi D6/334
D586,590 S * 2/2009 Schweikarth D6/716
D624,328 S * 9/2010 Grandin D6/381
D639,083 S * 6/2011 Martin D6/381
D657,155 S * 4/2012 Grandin D6/381
D657,964 S * 4/2012 Amini D6/334
D662,733 S * 7/2012 Metcalf D6/717
D668,892 S * 10/2012 Metcalf D6/717
D699,460 S * 2/2014 Bosman D6/371
D717,552 S * 11/2014 Baraldi D6/334
D717,553 S * 11/2014 Baraldi D6/334
D753,928 S * 4/2016 Webb D6/378

* cited by examiner

FIG. 1

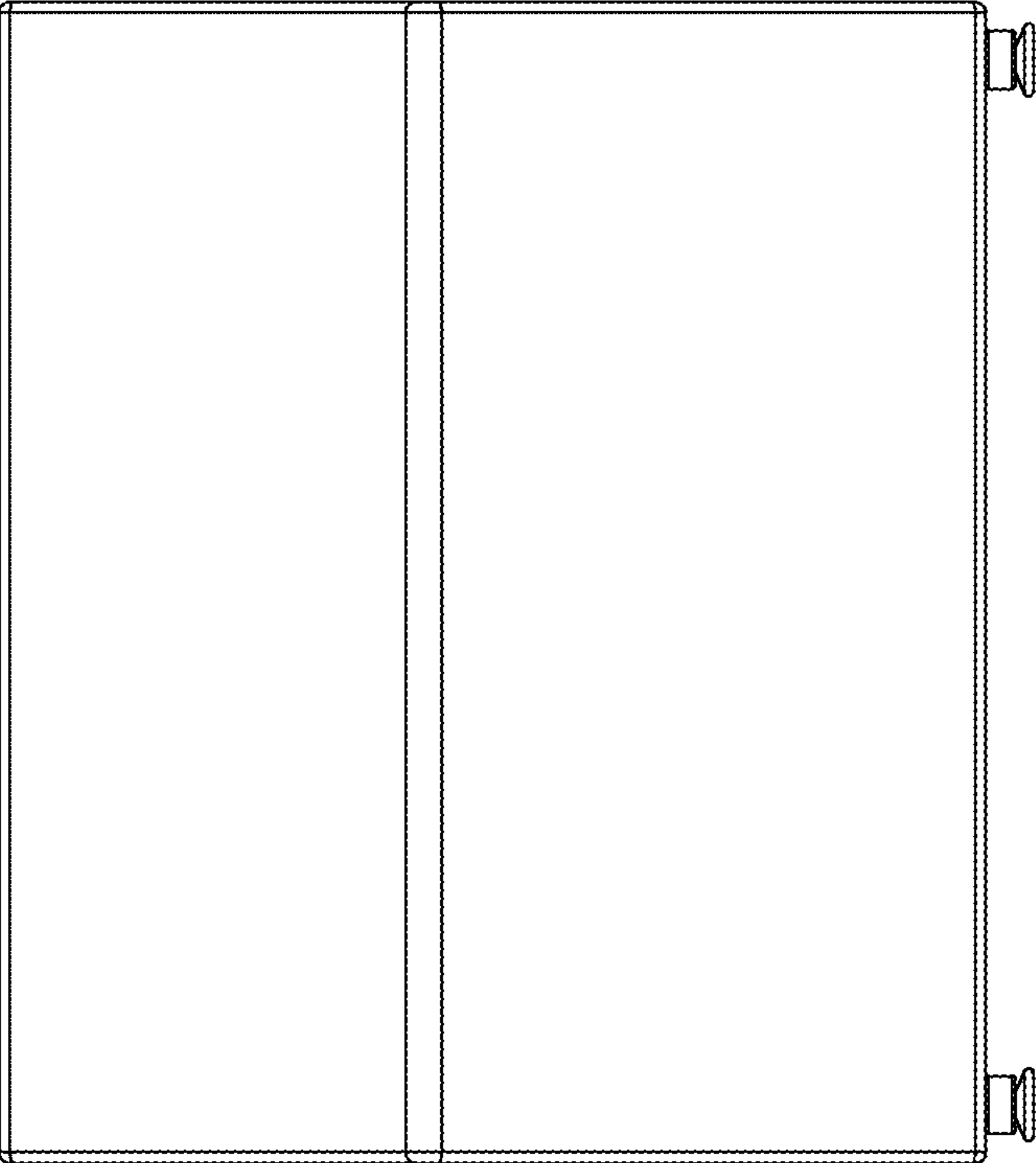

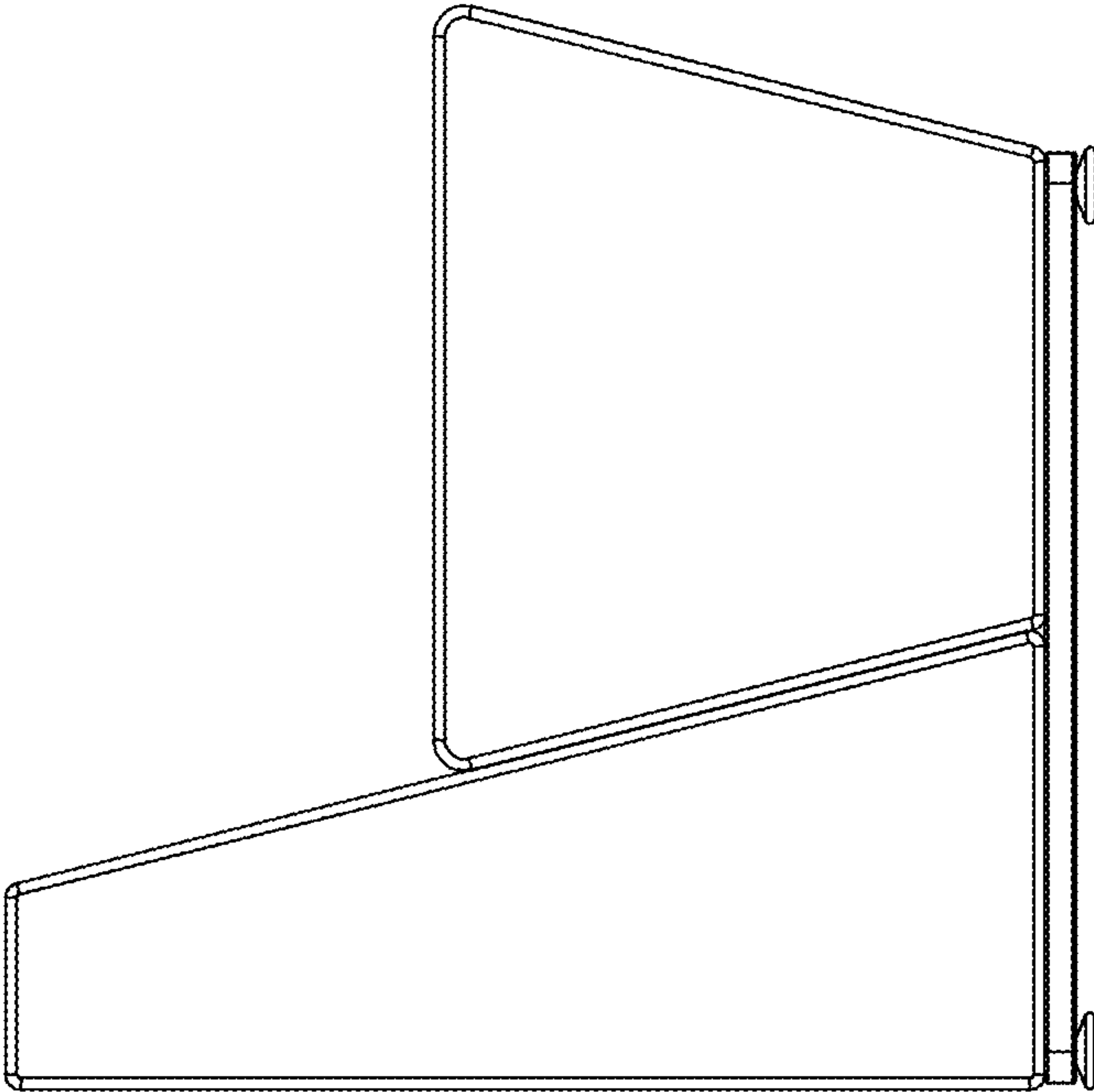

FIG. 2

FIG. 3

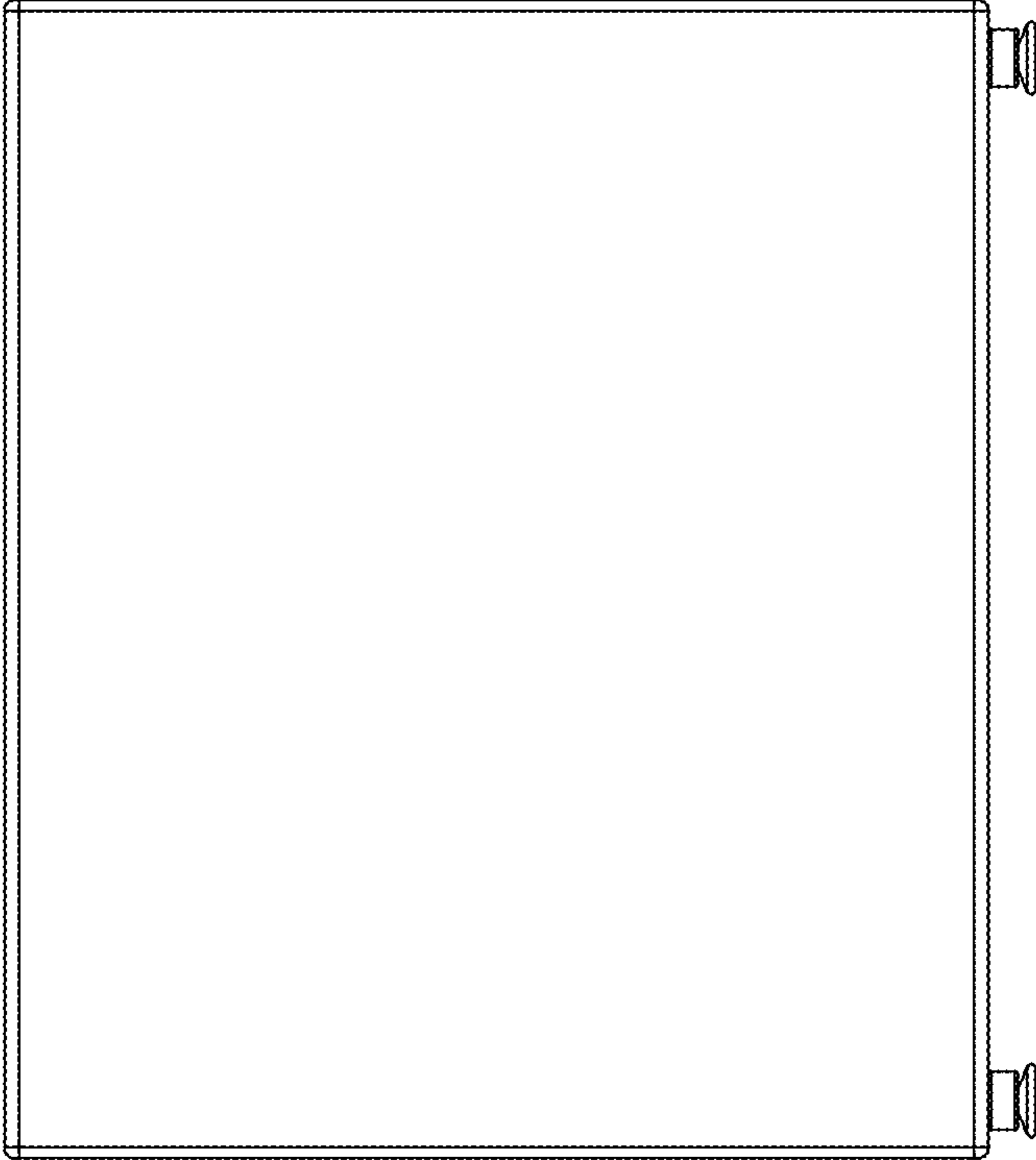

FIG. 4

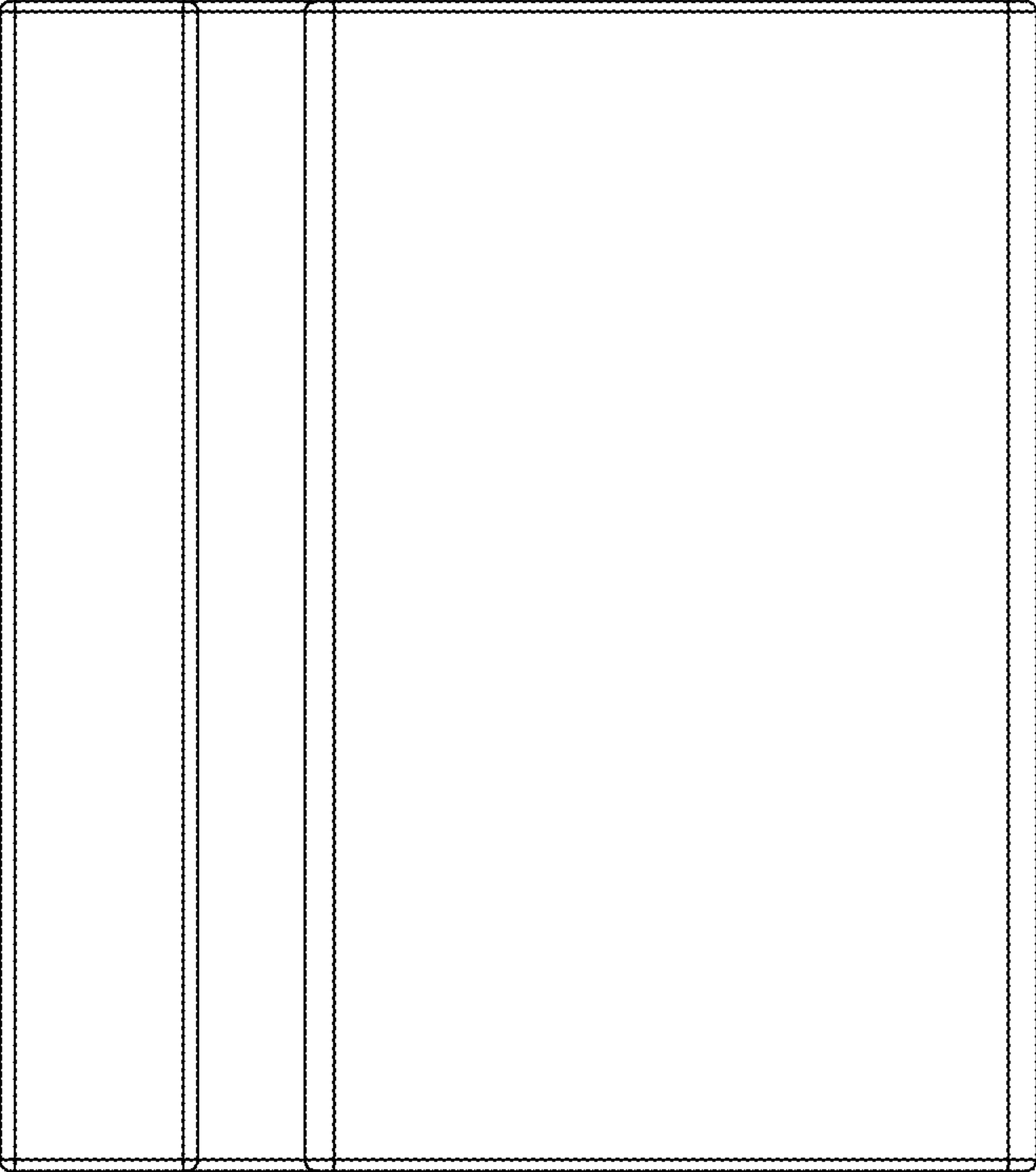

FIG. 5

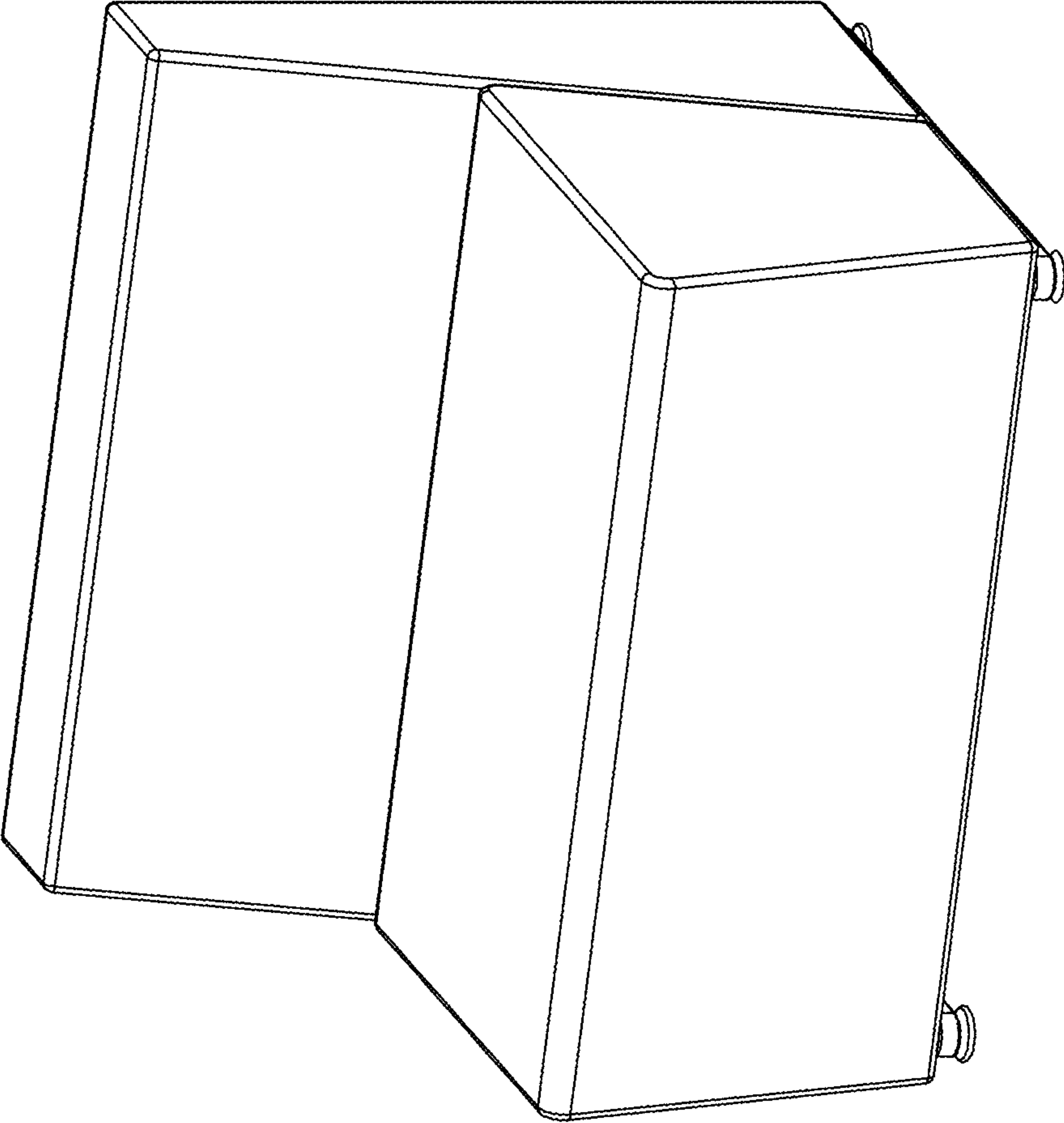

FIG. 6

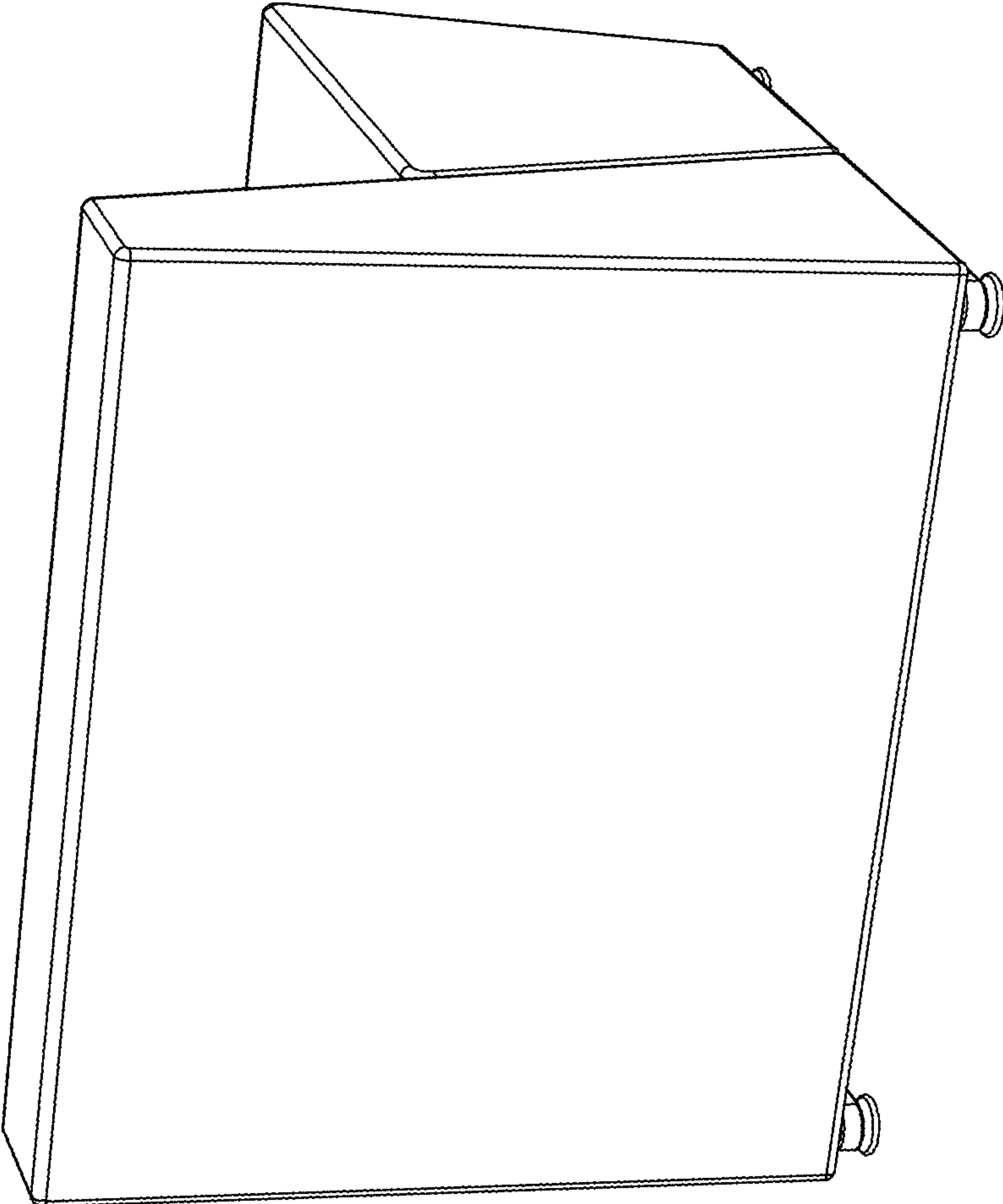

FIG. 7

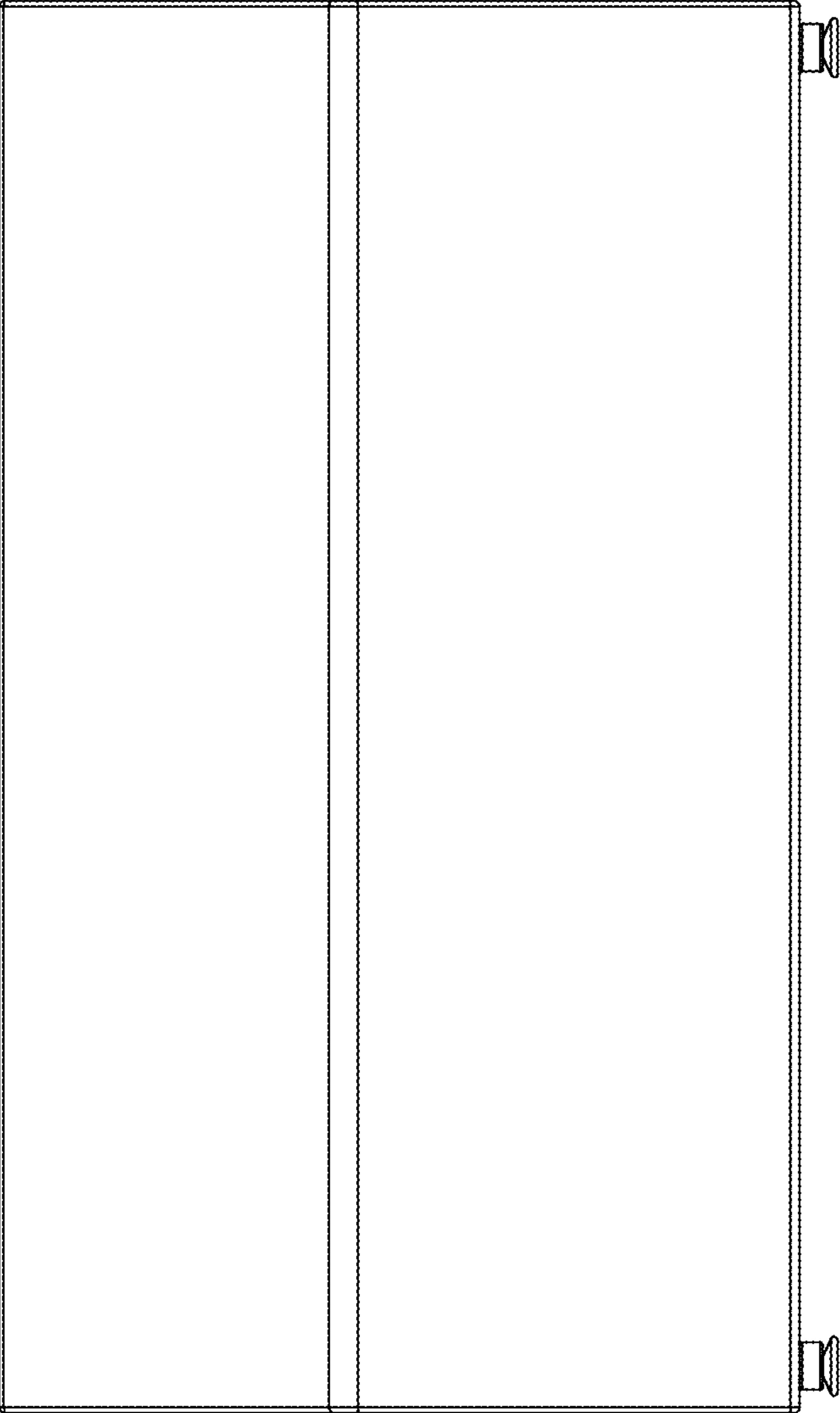

FIG. 8

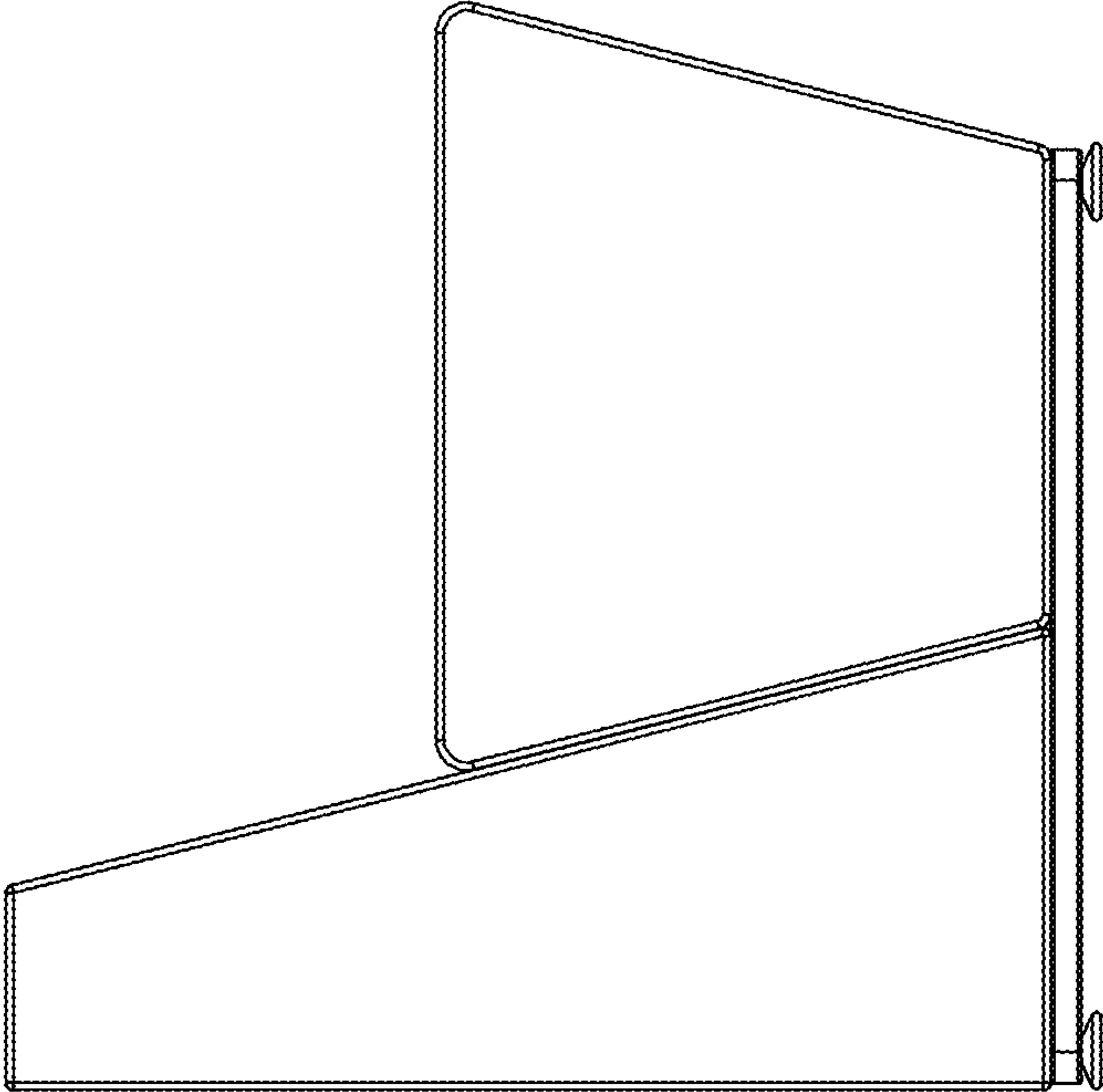

FIG. 9

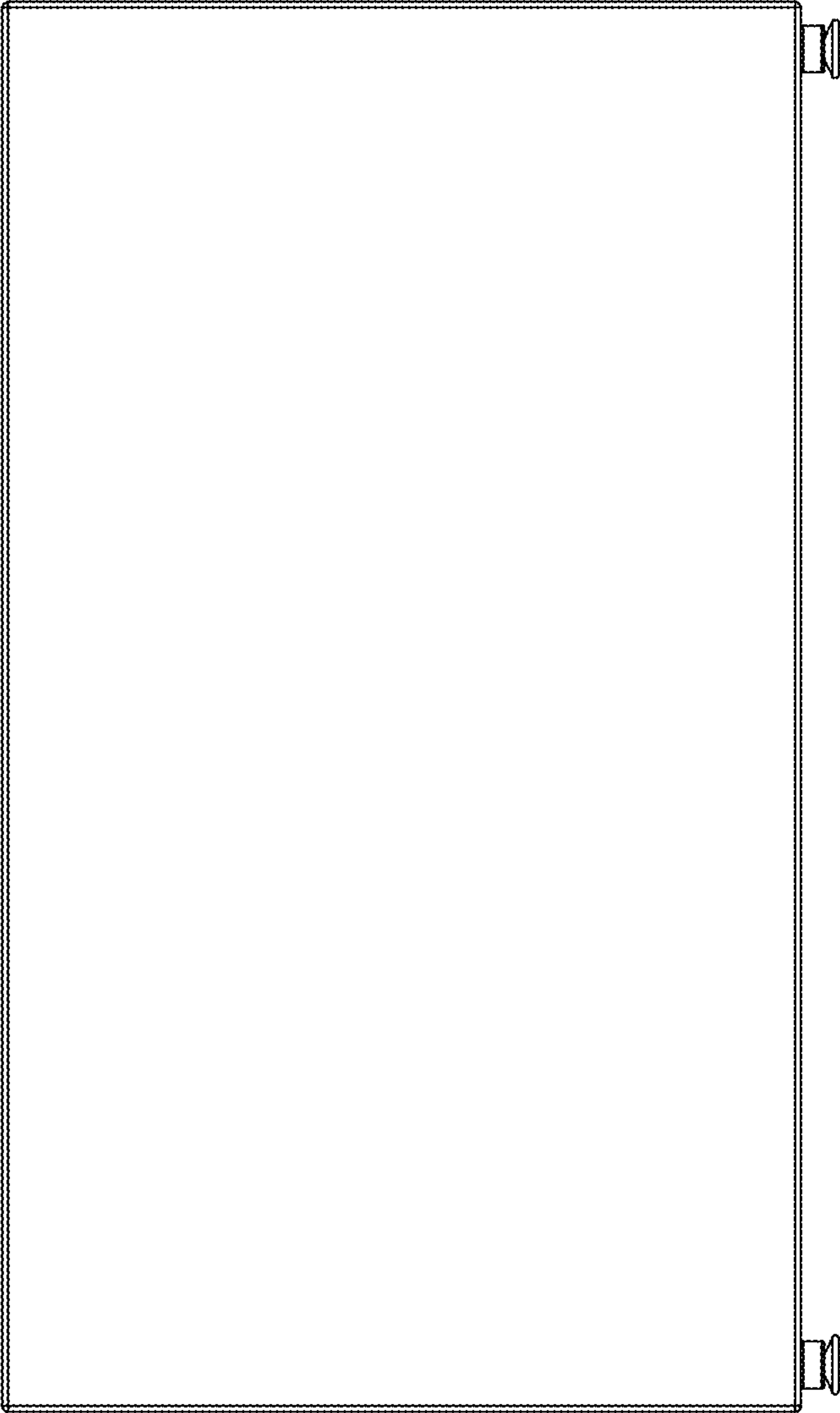

FIG. 10

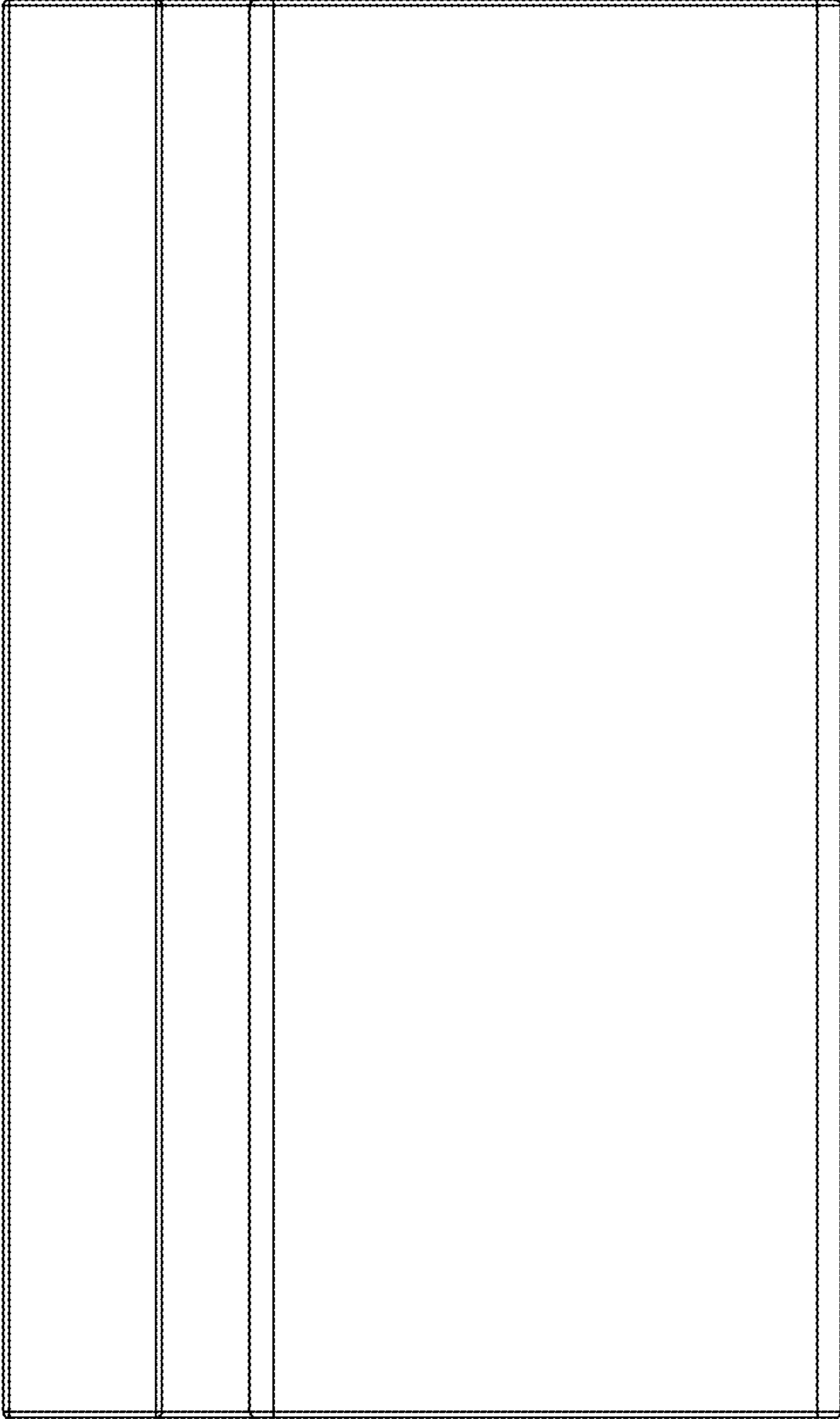
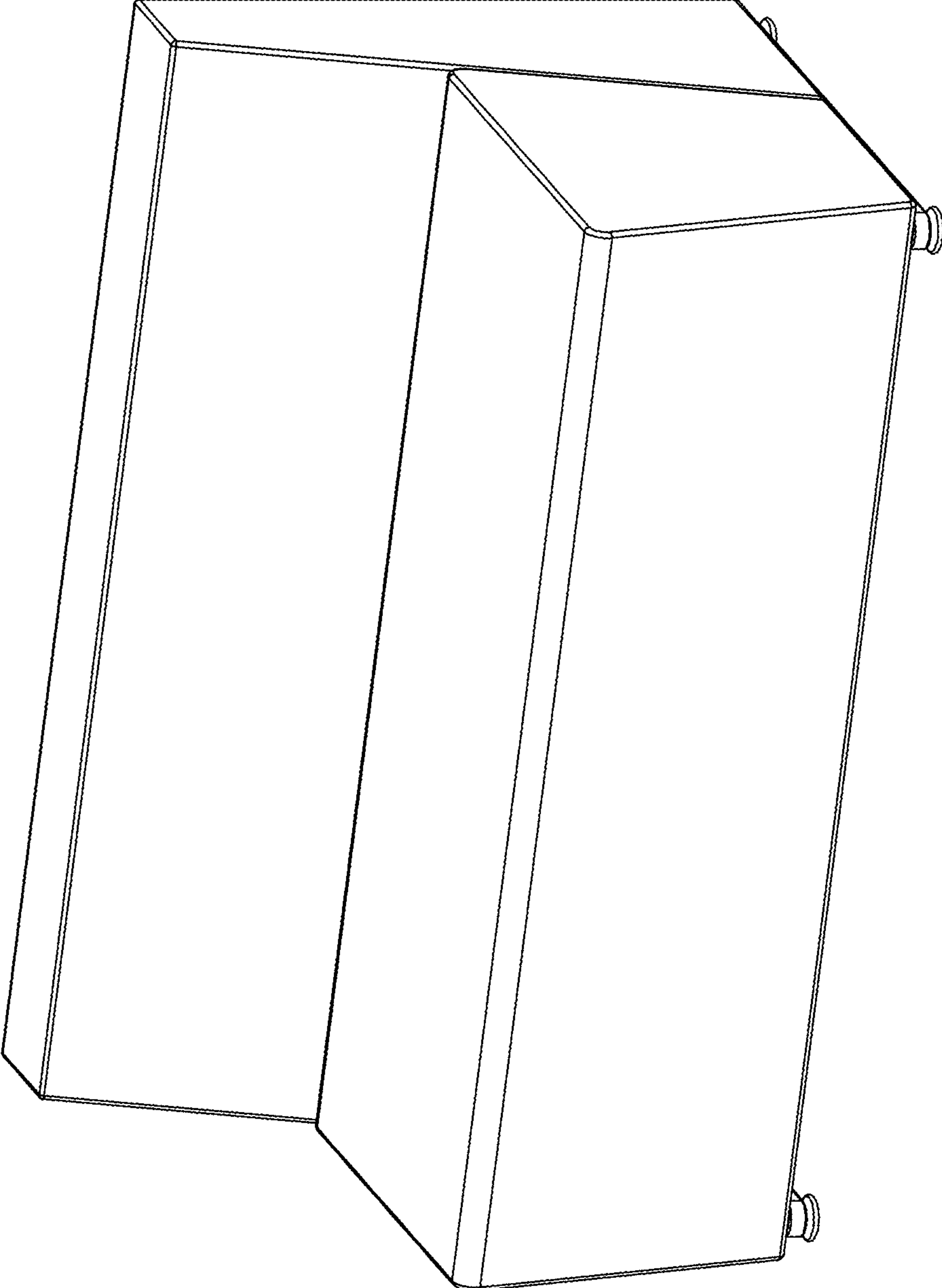

FIG. 11



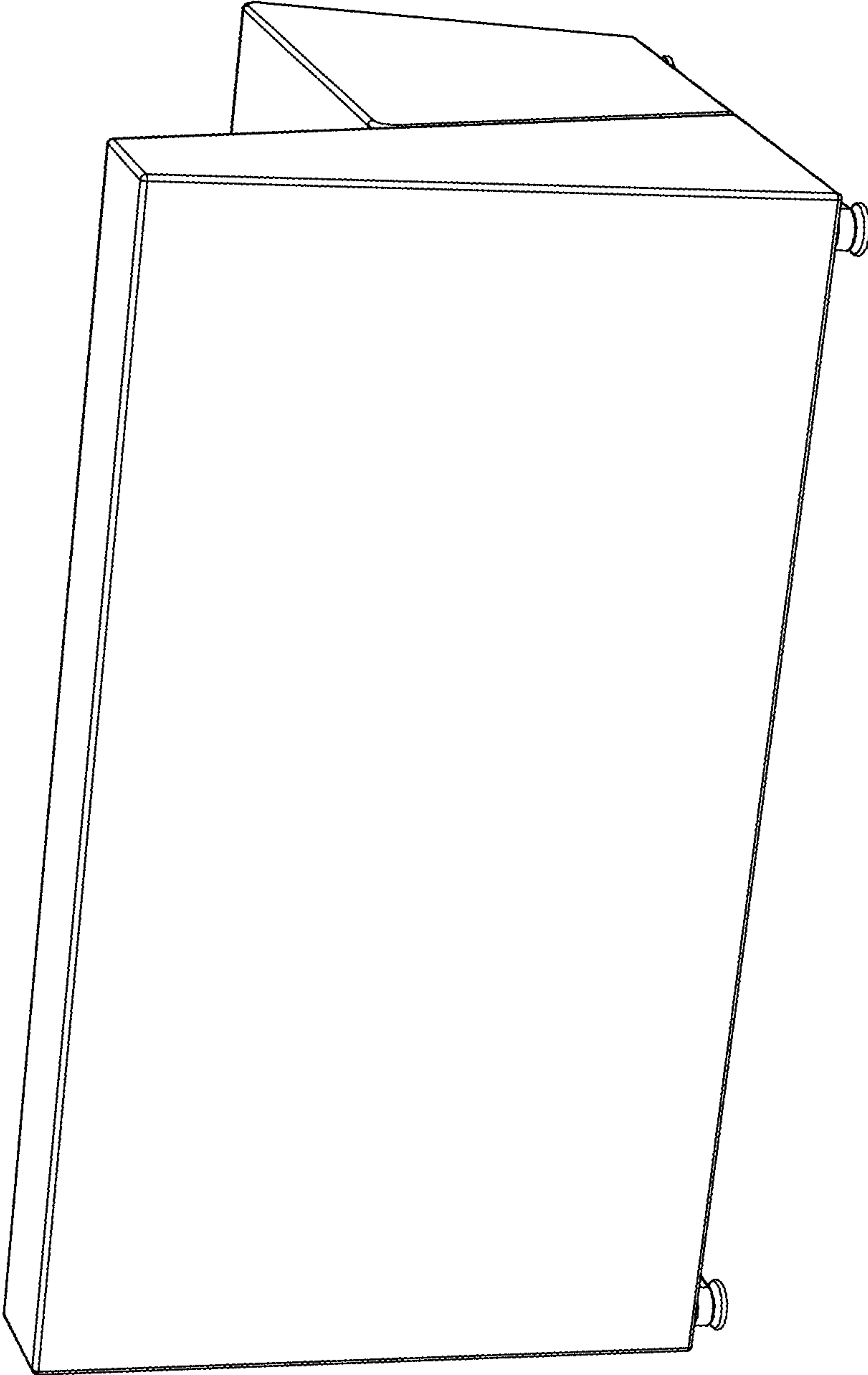

FIG. 12

FIG. 13

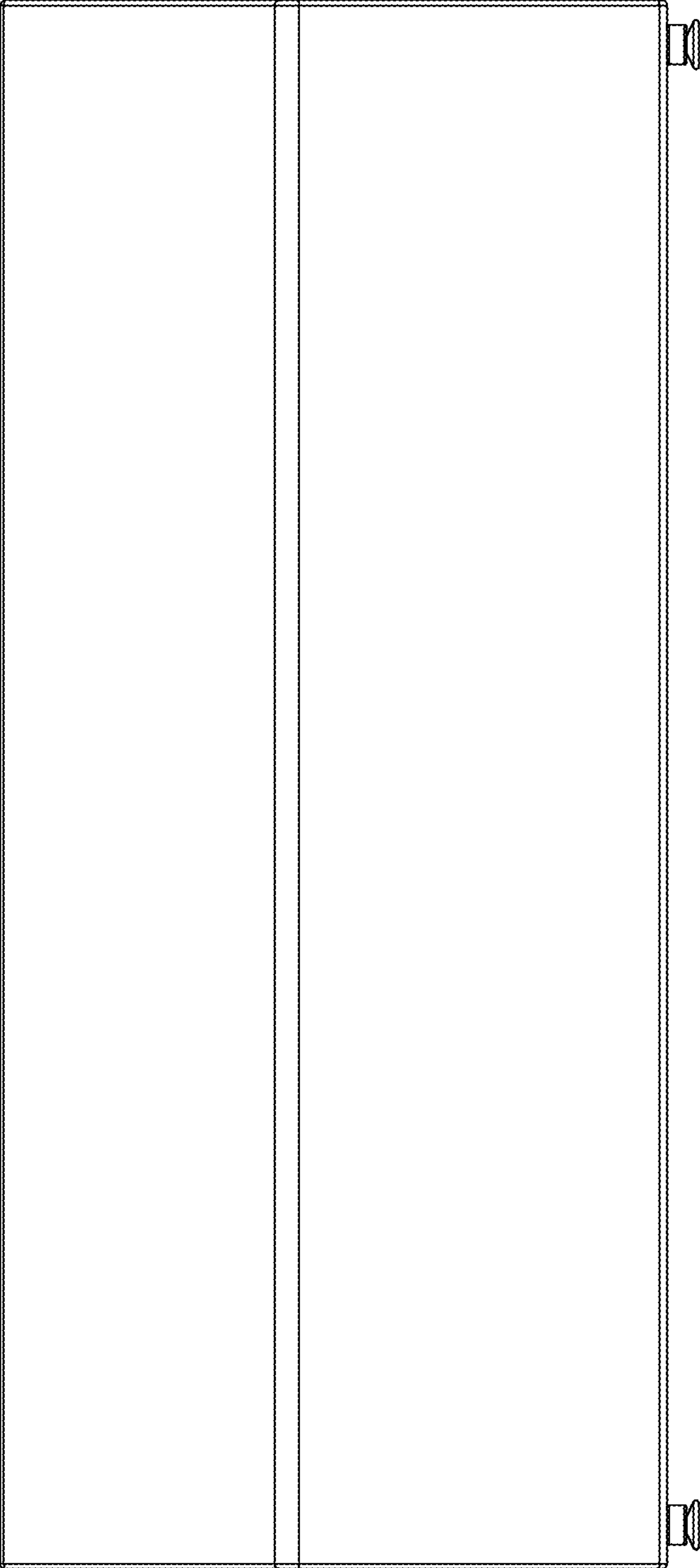

FIG. 14

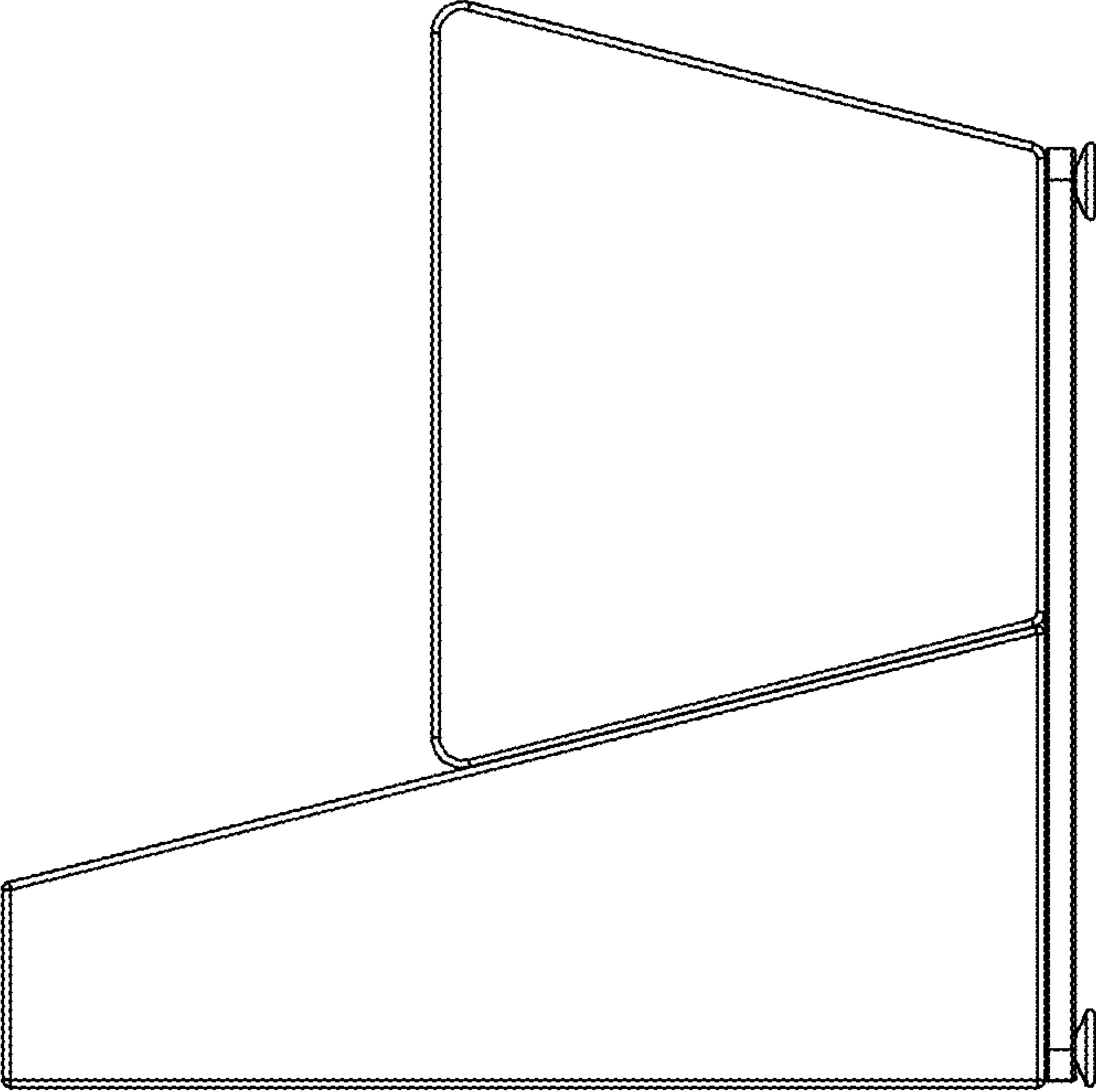

FIG. 15

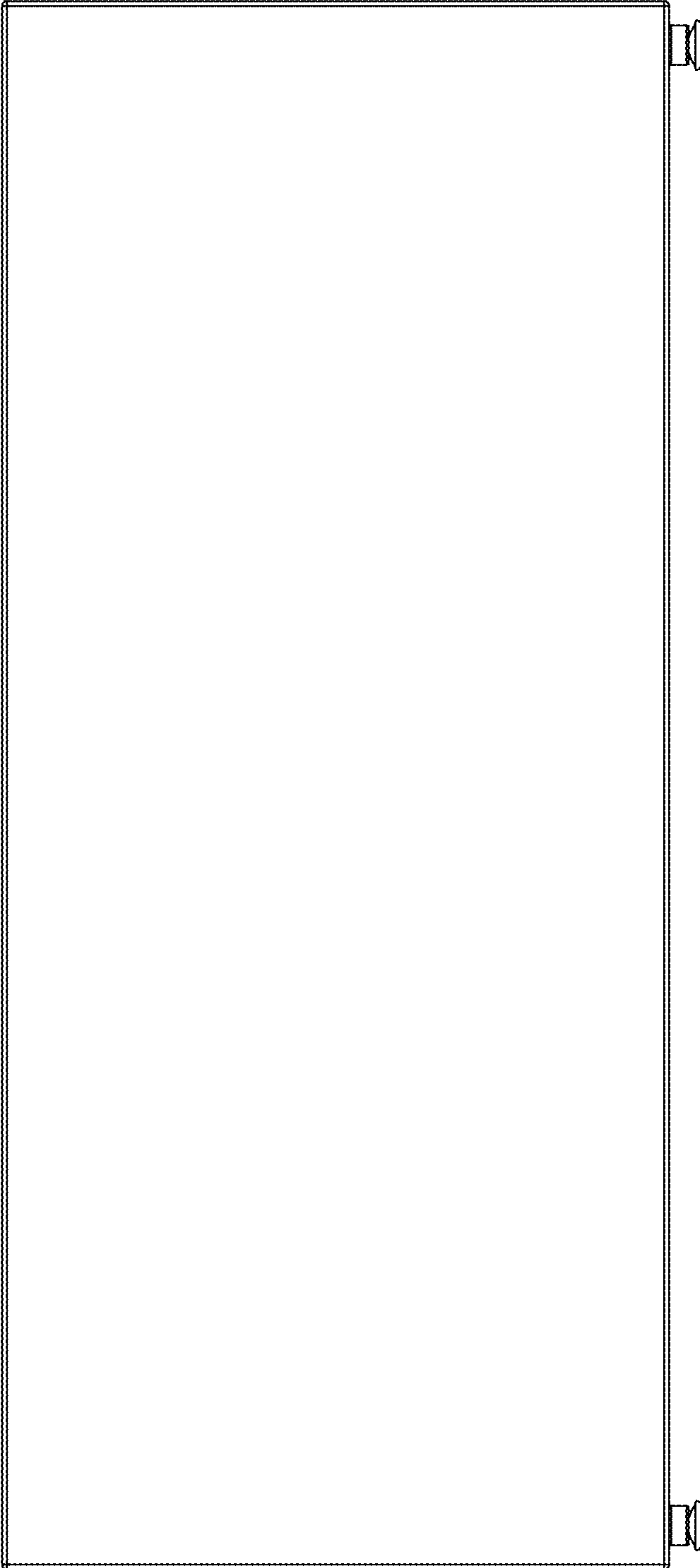
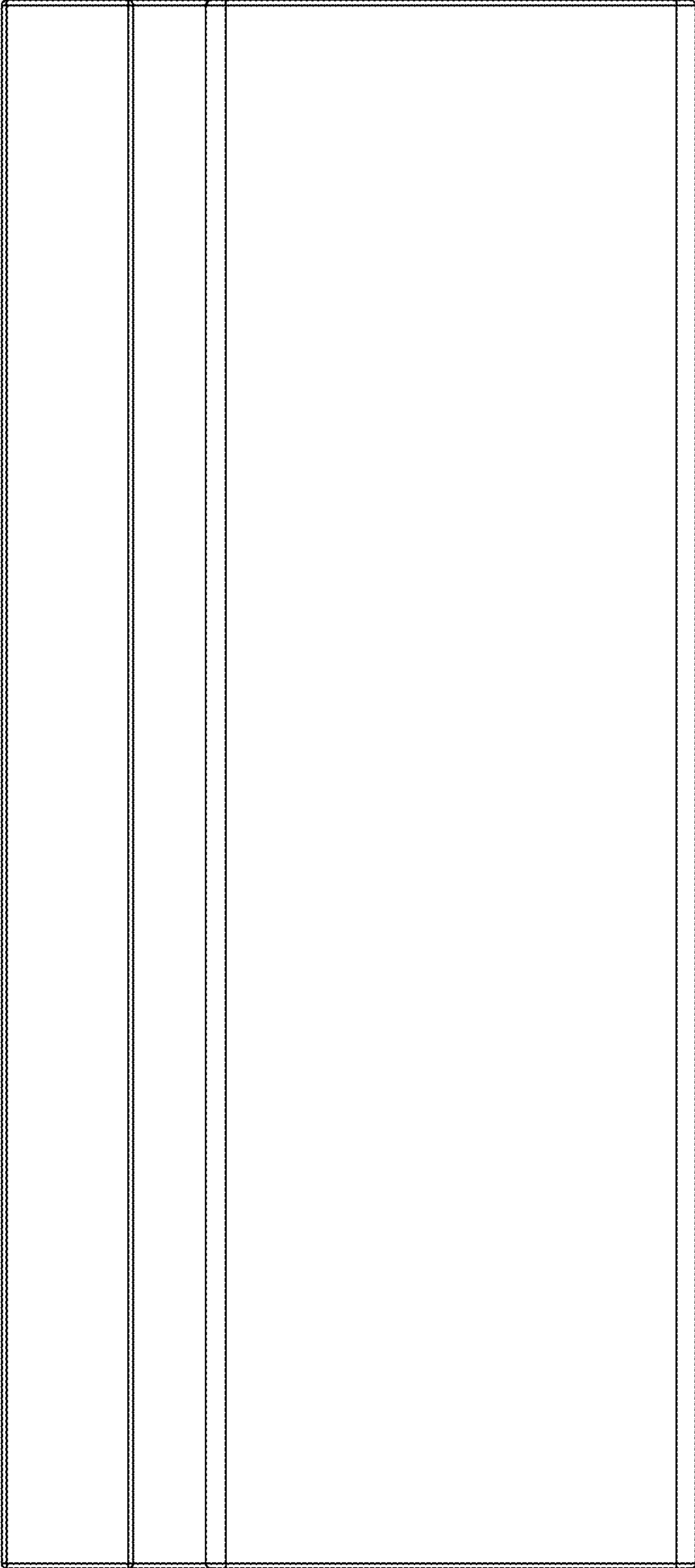

FIG. 16



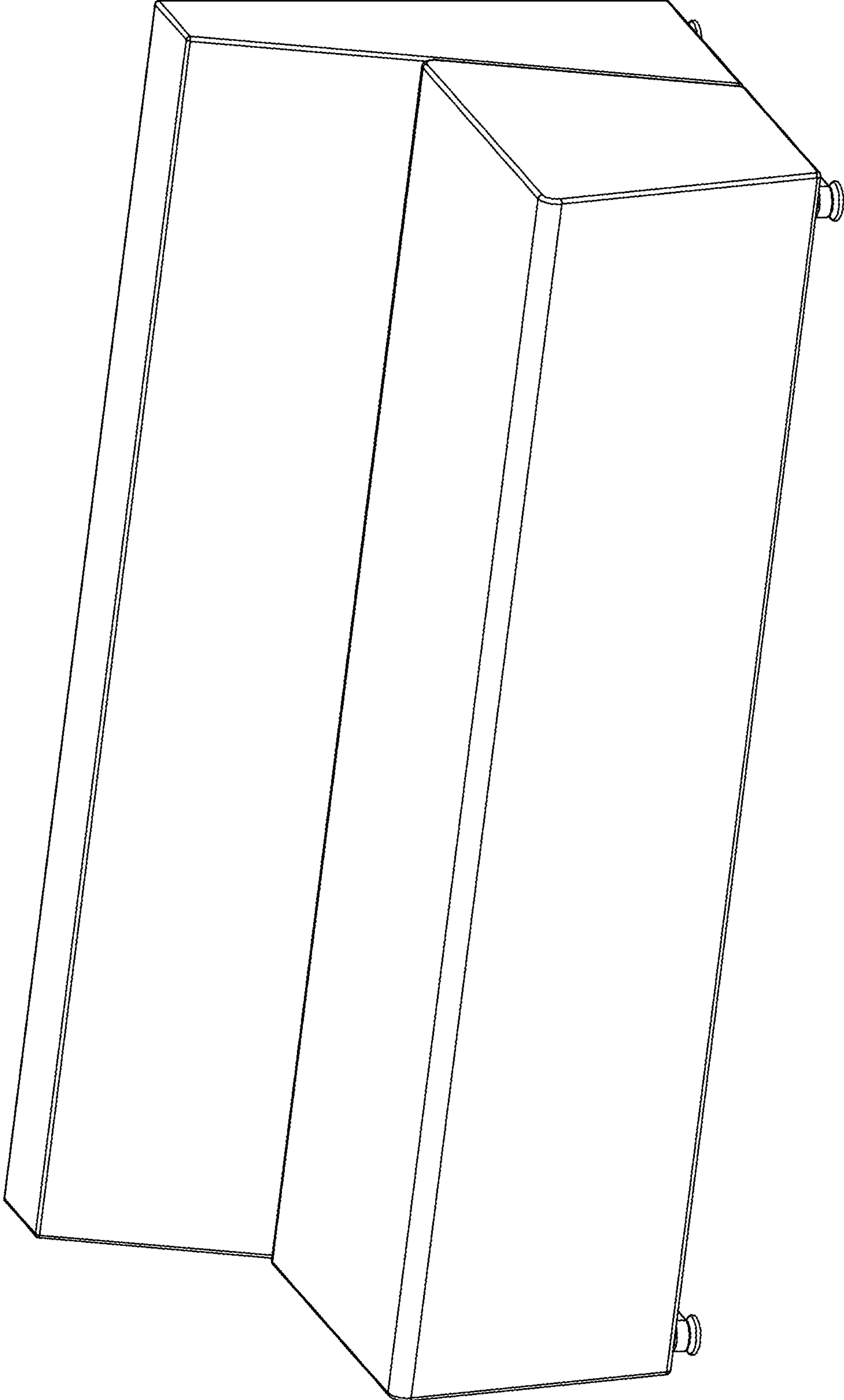

FIG. 17

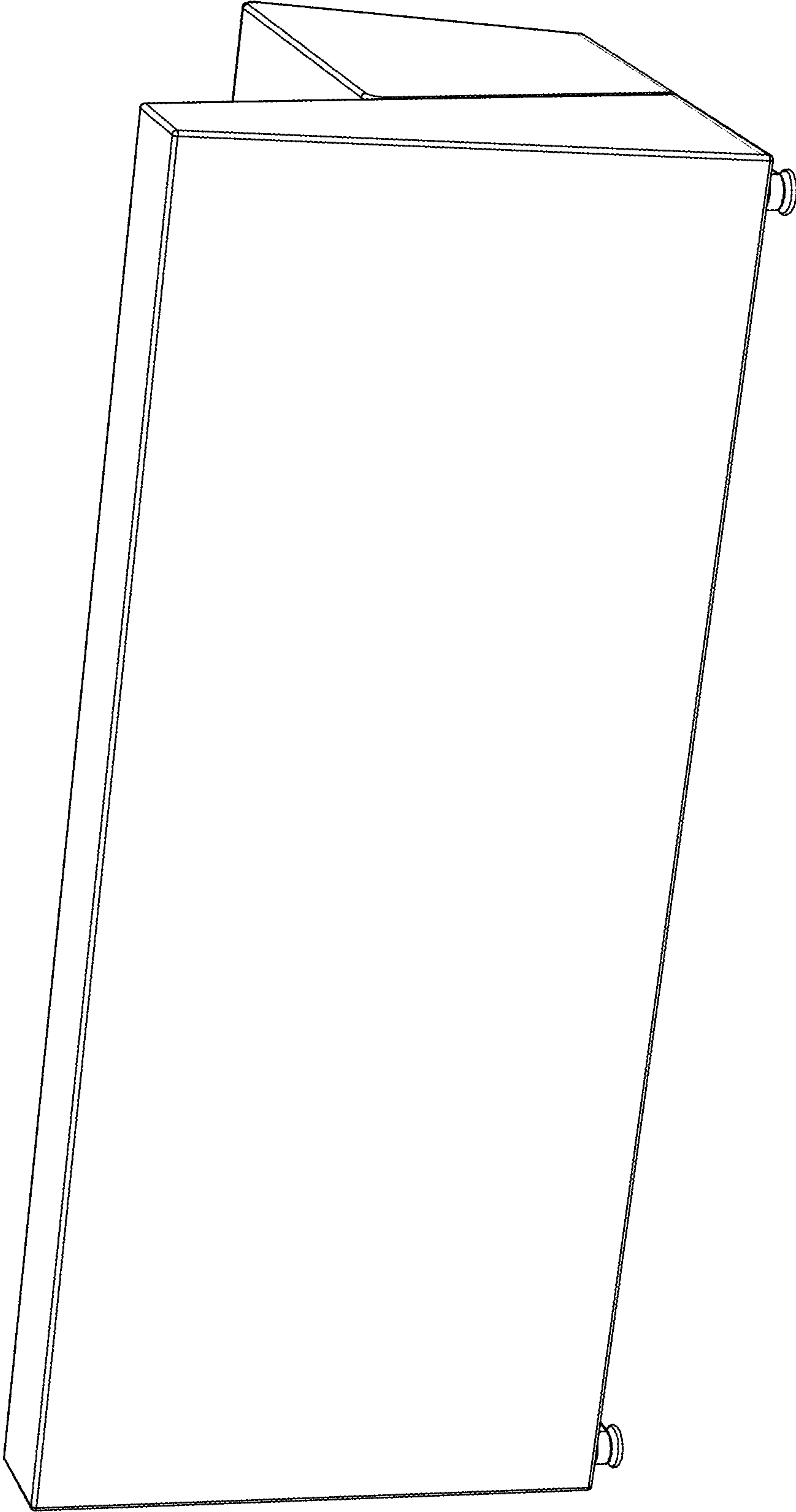

FIG. 18