



US00D774308S

(12) **United States Design Patent** (10) **Patent No.:** **US D774,308 S**
Sedic (45) **Date of Patent:** **** Dec. 20, 2016**

(54) **TONGUE CLEANER**
(71) Applicant: **Filip Sedic**, Stockholm (SE)
(72) Inventor: **Filip Sedic**, Stockholm (SE)
(**) Term: **15 Years**
(21) Appl. No.: **29/535,198**
(22) Filed: **Aug. 4, 2015**
(51) **LOC (10) Cl.** **28-03**
(52) **U.S. Cl.**
USPC **D4/101**
(58) **Field of Classification Search**
USPC ... D4/101, 104-112, 113, 132-134; 15/22.1,
15/59.1, 167.1, 401, 105, 106; 132/309;
433/216; D24/146, 147; 606/161
CPC A46B 2200/1066; A46B 15/0071;
A46B 15/0002; A46B 5/02; A46B
15/0055; A46D 1/00; A45D 44/18; A61C
19/066; A61B 17/244
See application file for complete search history.

D392,386 S 3/1998 Nguyen
5,779,475 A * 7/1998 Patel A61B 17/244
15/236.08
5,792,159 A 8/1998 Amin
D402,811 S * 12/1998 Stansbury, Jr. D4/101
D404,487 S * 1/1999 Bertella D24/147
D406,891 S * 3/1999 Smith D24/147
D408,534 S * 4/1999 Jansheski D24/147
5,893,860 A * 4/1999 Ripich A61B 17/244
606/161
5,947,912 A * 9/1999 Montagnino A61B 17/244
601/141
5,984,935 A 11/1999 Welt et al.
D423,785 S * 5/2000 Karallis D4/108
D465,847 S * 11/2002 Jacobs D24/147
D475,460 S * 6/2003 Latone D24/147
D484,312 S * 12/2003 Li D4/101
D484,978 S * 1/2004 Syal D24/147
D499,884 S * 12/2004 Chan D4/101
D508,325 S * 8/2005 Zunga D4/108

(Continued)

Primary Examiner — John Windmuller
Assistant Examiner — Steven Czyz
(74) *Attorney, Agent, or Firm* — Fenwick & West LLP

(56) **References Cited**

U.S. PATENT DOCUMENTS

2,218,072 A 10/1940 Runnels
2,583,750 A 1/1952 Runnels
D237,187 S * 10/1975 Fattaleh et al. D24/146
D237,188 S * 10/1975 Fattaleh et al. D14/229
D246,878 S * 1/1978 Kitzis D24/139
D265,506 S * 7/1982 Finamore D24/147
D291,001 S * 7/1987 Gaskins D24/147
D294,885 S * 3/1988 Mollenhoff 15/23
D295,695 S * 5/1988 Golzari D24/149
D301,372 S * 5/1989 Tsen D24/147
D324,912 S * 3/1992 Hansen D24/146
D367,707 S * 3/1996 Baker D24/146
D378,411 S * 3/1997 Taoatao D24/147
D385,962 S * 11/1997 Conrey D24/147
D391,370 S * 2/1998 Cho D24/147

(57) **CLAIM**

I claim the ornamental design for a tongue cleaner, as shown and described.

DESCRIPTION

FIG. 1 is a perspective view of a tongue cleaner;
FIG. 2 is a front view thereof;
FIG. 3 is a back view thereof;
FIG. 4 is a right side view thereof;
FIG. 5 is a left side view thereof;
FIG. 6 is a top view thereof; and,
FIG. 7 is a bottom view thereof.
The broken lines depict portions of the article that form no part of the claimed design.

1 Claim, 7 Drawing Sheets

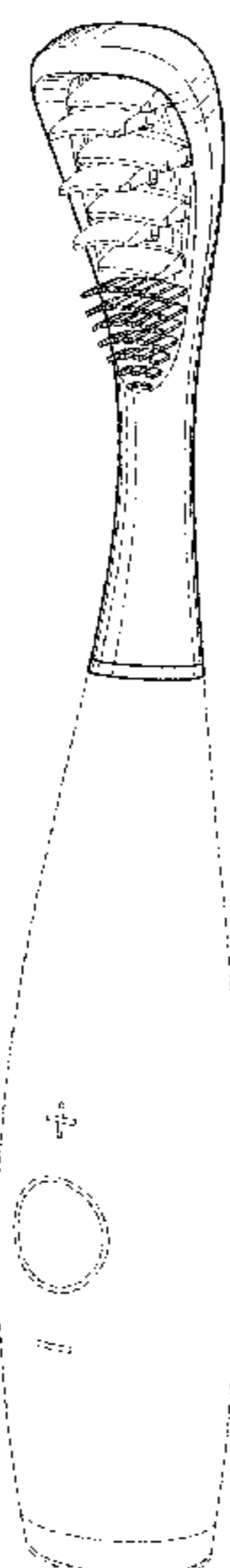

(56)

References Cited

U.S. PATENT DOCUMENTS

D515,817	S *	2/2006	Siemer	D4/108
D527,821	S *	9/2006	Cwik	D24/147
D529,174	S	9/2006	Kling et al.	
D536,452	S *	2/2007	Geiberger	D24/147
D538,929	S	3/2007	Chuang	
D567,945	S *	4/2008	Foster	D24/147
D571,470	S *	6/2008	Jansheski	D24/147
D583,943	S *	12/2008	Zaksenberg	D24/147
D595,963	S *	7/2009	Gronikowski	D4/108
D651,808	S *	1/2012	Nguyen	D4/108
D652,925	S *	1/2012	Nanda	D24/147
D661,098	S *	6/2012	Nanda	D4/101
D696,517	S *	12/2013	Gebski	D4/101
8,740,788	B1	6/2014	Mettler	
D710,109	S *	8/2014	Nanda	D4/104
D736,379	S *	8/2015	Wong	D24/147
D749,324	S *	2/2016	Cessot	D4/101
D749,853	S *	2/2016	Cessot	D4/101
2004/0092981	A1 *	5/2004	Barlow	A61B 17/244 606/161
2006/0052805	A1	3/2006	Cwik	
2006/0058821	A1 *	3/2006	Jansheski	A61B 17/244 606/161
2008/0208228	A1	8/2008	Mueller	
2009/0111069	A1	4/2009	Wagner	
2009/0130637	A1	5/2009	Pantangco	
2011/0289707	A1	12/2011	Schaefer et al.	
2013/0000658	A1	1/2013	Nguyen et al.	
2014/0298605	A1	10/2014	Ivory	
2015/0283401	A1 *	10/2015	Cha	A46B 15/0036 433/29
2016/0051271	A1 *	2/2016	Bock	A61B 17/244 606/161

* cited by examiner

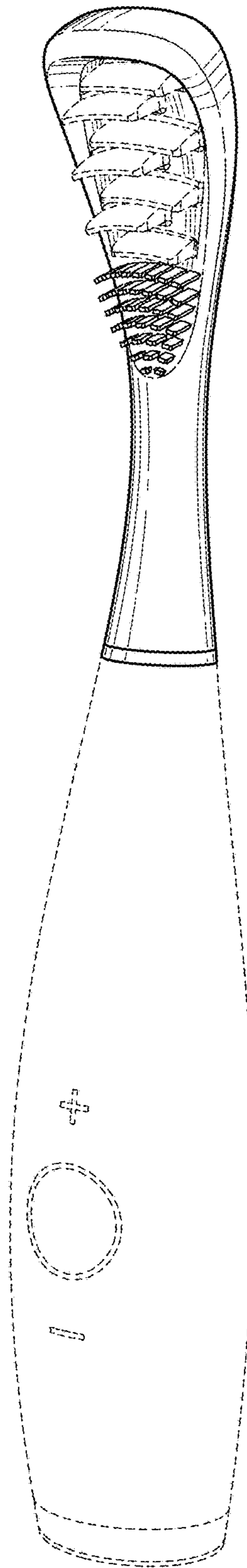

FIG. 1

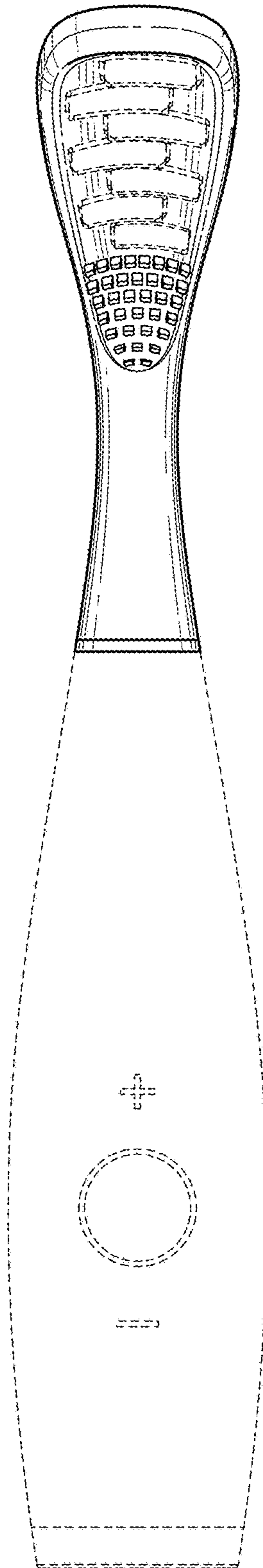

FIG. 2

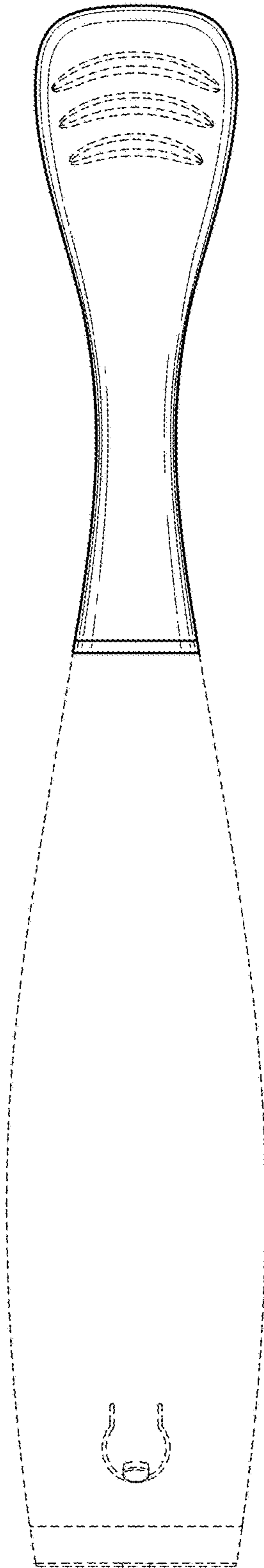

FIG. 3

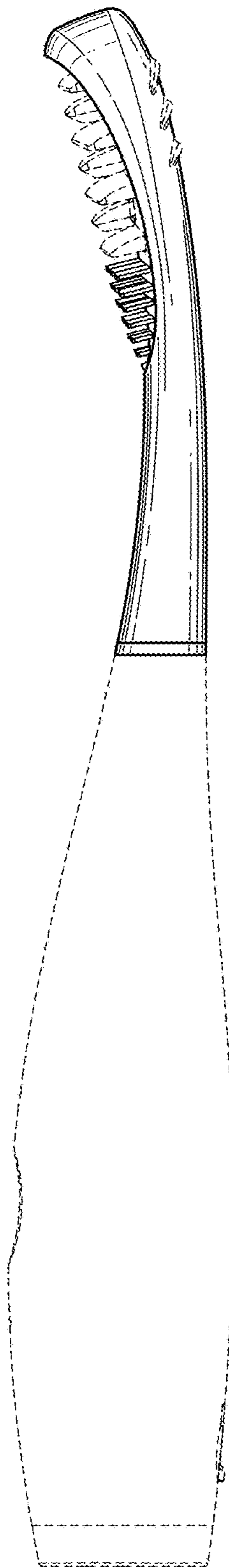

FIG. 4

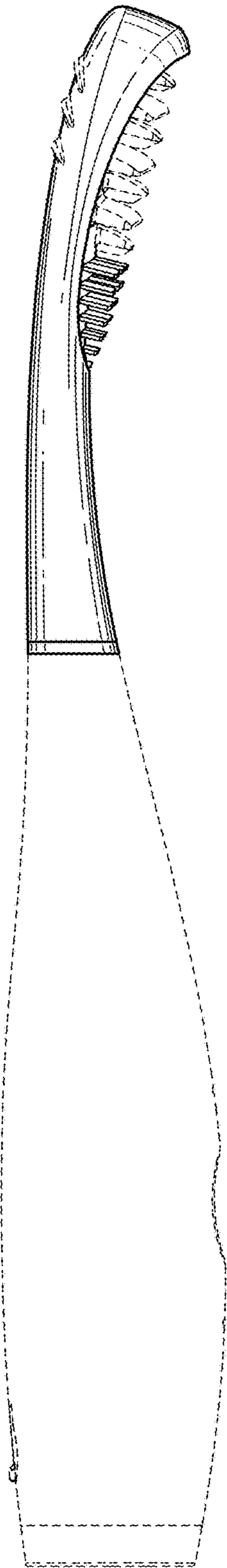

FIG. 5

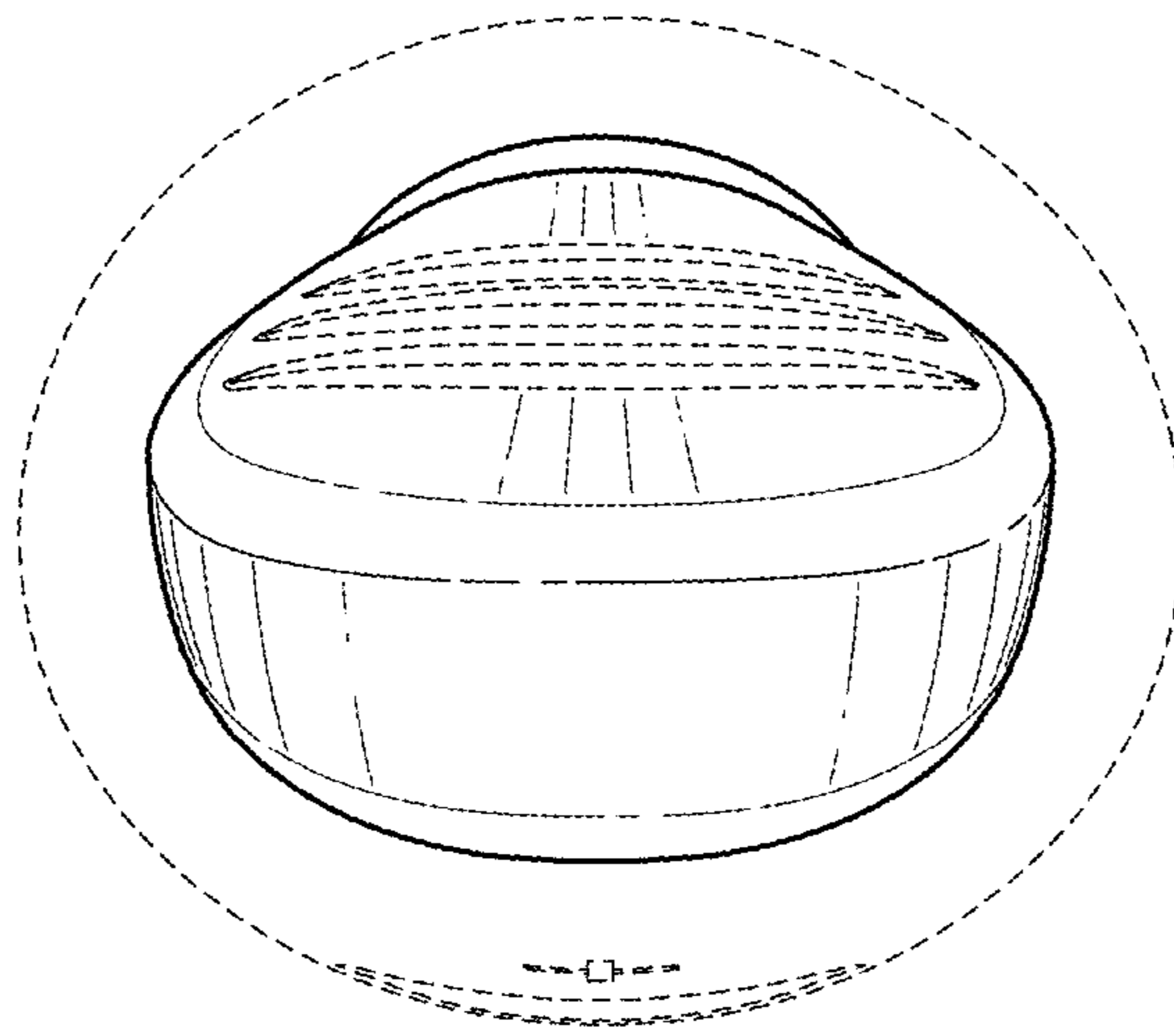

FIG. 6

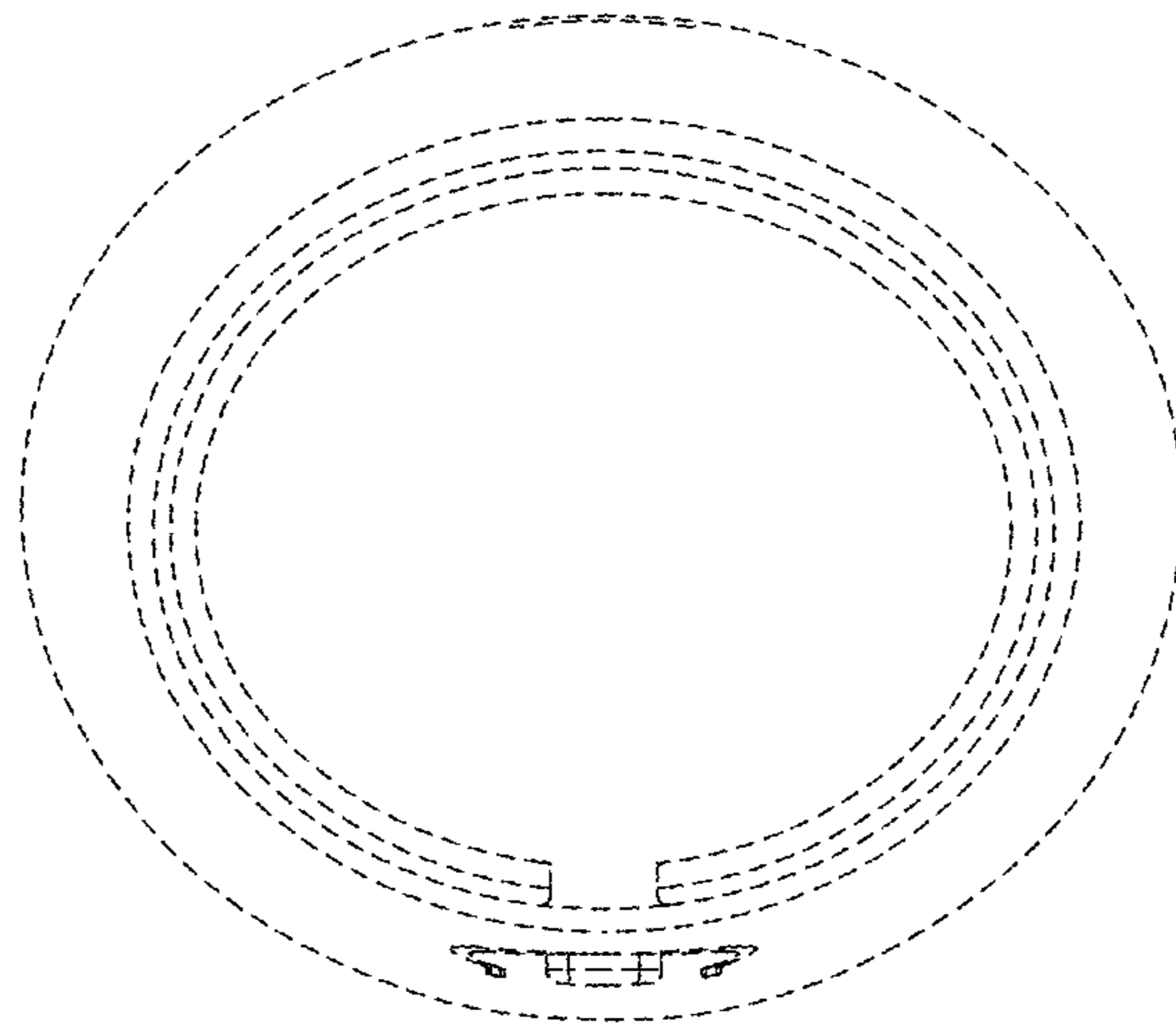

FIG. 7