



US00D774257S

(12) **United States Design Patent**  
**LaRocque**

(10) **Patent No.:** **US D774,257 S**

(45) **Date of Patent:** **\*\* Dec. 13, 2016**

(54) **HELMET**

(71) Applicant: **Joey LaRocque**, Agoura Hills, CA (US)

(72) Inventor: **Joey LaRocque**, Agoura Hills, CA (US)

(\*\*) Term: **14 Years**

(21) Appl. No.: **29/517,306**

(22) Filed: **Feb. 11, 2015**

(51) **LOC (10) Cl.** ..... **09-03**

(52) **U.S. Cl.**  
USPC ..... **D29/106**

(58) **Field of Classification Search**  
USPC ..... D29/102-107, 122

(Continued)

(56) **References Cited**

**U.S. PATENT DOCUMENTS**

1,434,607 A 11/1922 Gilson  
1,841,232 A 1/1932 Wells

(Continued)

**FOREIGN PATENT DOCUMENTS**

EP 0930832 8/1997  
WO 9708967 3/1997

**OTHER PUBLICATIONS**

<http://www.amazon.com/Best-Sellers-Sports-Outdoors-Rugby-Headguards/zgbs/sporting-goods/3416031>. (Amazon Best Sellers\_ best Rugby Headguards) (last accessed Jul. 22, 2015).

*Primary Examiner* — Ruth McInroy

(74) *Attorney, Agent, or Firm* — McAndrews, Held & Malloy, Ltd.

(57) **CLAIM**

The ornamental design for a helmet, as shown and described.

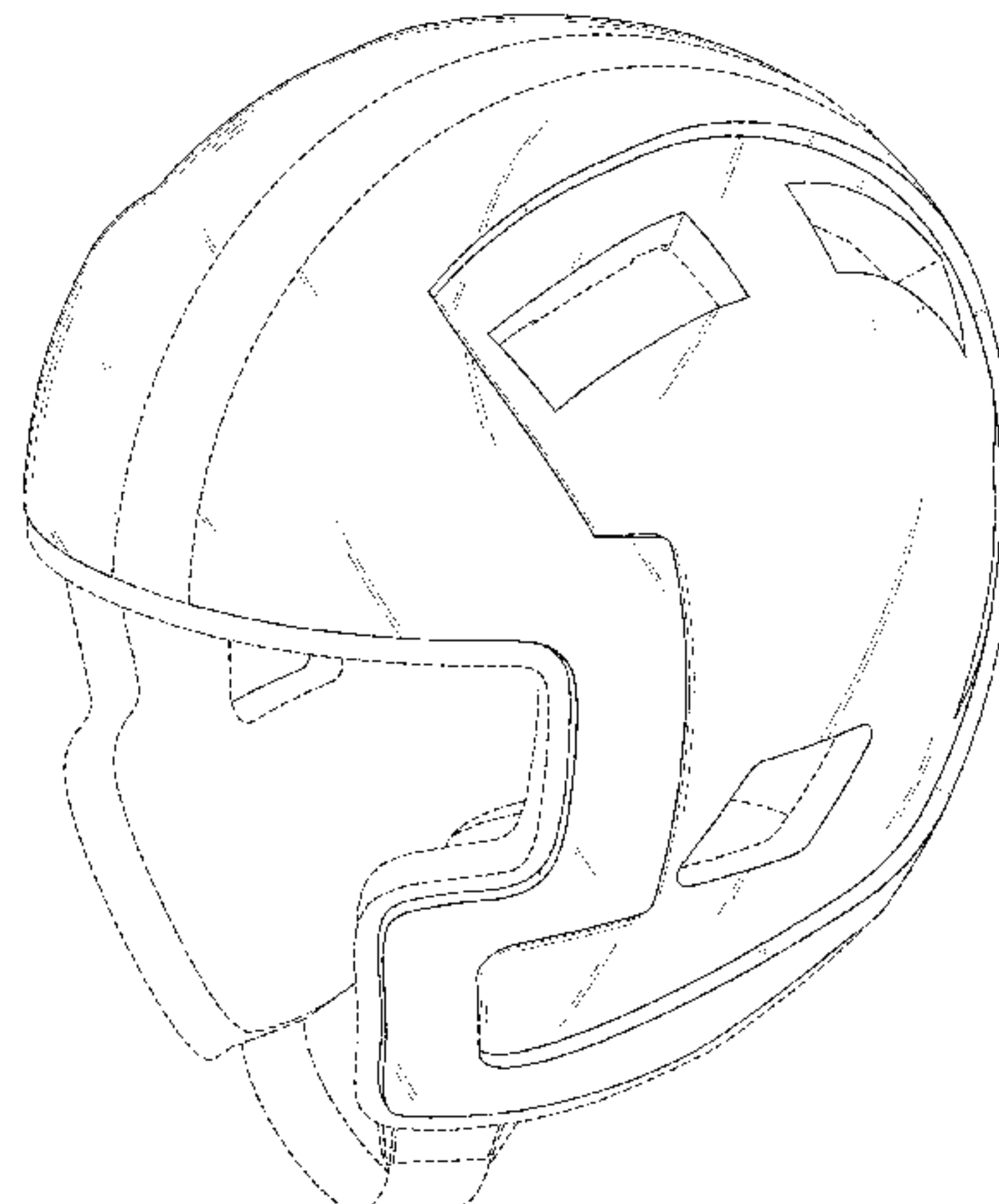
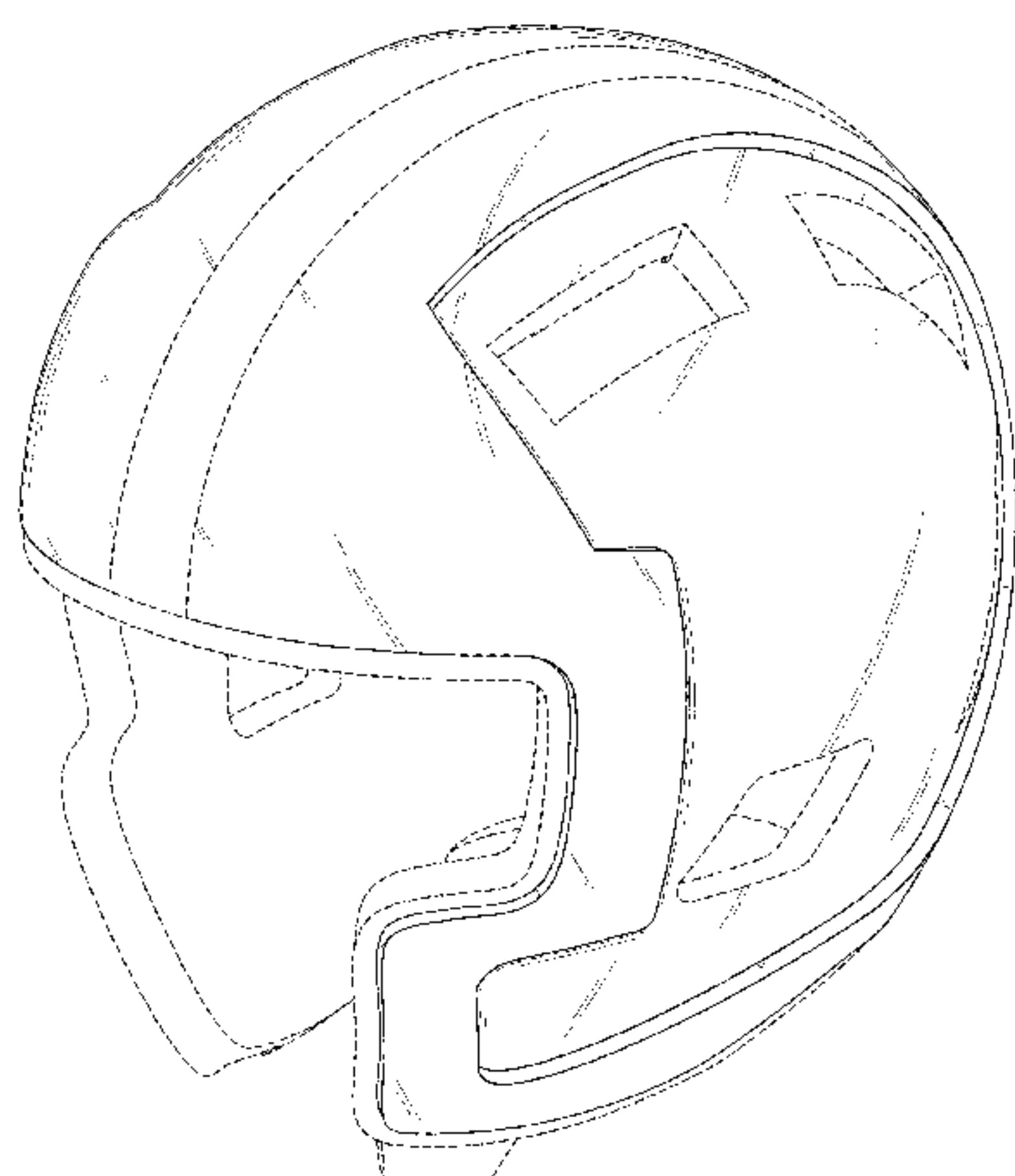
**DESCRIPTION**

FIG. 1 is a top perspective view of a first embodiment of a helmet showing my new design;

FIG. 2 is a bottom perspective view thereof;  
FIG. 3 is a front elevation view thereof;  
FIG. 4 is a rear elevation view thereof;  
FIG. 5 is a left side elevation view thereof;  
FIG. 6 is a right side elevation view thereof;  
FIG. 7 is a top plan view thereof;  
FIG. 8 is a bottom plan view thereof;  
FIG. 9 is a top perspective view of a second embodiment of a helmet showing my new design;  
FIG. 10 is a bottom perspective view thereof;  
FIG. 11 is a front elevation view thereof;  
FIG. 12 is a rear elevation view thereof;  
FIG. 13 is a left side elevation view thereof;  
FIG. 14 is a right side elevation view thereof;  
FIG. 15 is a top plan view thereof;  
FIG. 16 is a bottom plan view thereof;  
FIG. 17 is a top perspective view of a third embodiment of a helmet showing my new design;  
FIG. 18 is a bottom perspective view thereof;  
FIG. 19 is a front elevation view thereof;  
FIG. 20 is a rear elevation view thereof;  
FIG. 21 is a left side elevation view thereof;  
FIG. 22 is a right side elevation view thereof;  
FIG. 23 is a top plan view thereof;  
FIG. 24 is a bottom plan view thereof;  
FIG. 25 is a top perspective view of a fourth embodiment of a helmet showing my new design;  
FIG. 26 is a bottom perspective view thereof;  
FIG. 27 is a front elevation view thereof;  
FIG. 28 is a rear elevation view thereof;  
FIG. 29 is a left side elevation view thereof;  
FIG. 30 is a right side elevation view thereof;  
FIG. 31 is a top plan view thereof; and,  
FIG. 32 is a bottom plan view thereof.

The details shown in broken lines (including the Velcro on the strap) form no part of the claimed design.

**1 Claim, 32 Drawing Sheets**



(58) **Field of Classification Search**  
 CPC ..... A63B 71/10; A63B 71/222; A63B 71/04;  
 A63B 71/166; A63B 71/228; A63B 71/32;  
 A63B 71/105; A01K 55/00; A42B 3/222;  
 A42B 3/166; A42B 3/04; A42B  
 3/228; A42B 3/32; A42B 3/105; A42B  
 3/322  
 See application file for complete search history.

(56) **References Cited**  
 U.S. PATENT DOCUMENTS

D100,814 S 8/1936 Pryale  
 2,140,716 A 12/1938 Pryale  
 2,372,715 A 4/1945 Ernst  
 2,546,117 A 3/1951 Whelan  
 2,594,478 A 4/1952 Moore  
 2,664,567 A 1/1954 Nichols  
 2,777,127 A 1/1957 Marietta  
 D181,686 S 12/1957 Stuart  
 3,105,240 A 10/1963 Jansson  
 3,197,784 A 8/1965 Carlisle  
 3,323,134 A 6/1967 Swyers  
 D213,085 S 1/1969 Wyckoff  
 3,435,460 A 4/1969 Grant  
 3,551,911 A 1/1971 Holden  
 D220,376 S 4/1971 Brown  
 D224,182 S \* 7/1972 Kamata ..... D29/106  
 3,720,955 A 3/1973 Rawlings  
 D228,829 S \* 10/1973 Kamata ..... D29/107  
 3,761,959 A 10/1973 Dunning  
 D230,911 S 3/1974 Ispas  
 3,818,508 A 6/1974 Lammers  
 3,820,163 A 6/1974 Rappleyea  
 3,934,271 A 1/1976 Rhee  
 3,935,044 A 1/1976 Daly  
 3,978,527 A 9/1976 Bednar  
 D243,484 S 3/1977 Rhee  
 4,095,294 A 6/1978 Winterbottom  
 4,134,156 A 1/1979 Gyory  
 D253,976 S 1/1980 Davidson  
 D255,394 S 6/1980 McNabb  
 4,222,122 A 9/1980 Toms  
 4,279,038 A 7/1981 Bruckner  
 D272,960 S \* 3/1984 Vinson ..... D29/107  
 D295,800 S 5/1988 Shelton  
 4,754,501 A 7/1988 Yahn  
 D298,179 S 10/1988 Strong  
 D299,180 S 1/1989 Gentes  
 4,808,469 A 2/1989 Hiles  
 4,843,642 A 7/1989 Brower  
 4,845,786 A 7/1989 Chiarella  
 D310,434 S \* 9/1990 Breece ..... D29/103  
 5,012,533 A 5/1991 Raffler  
 D318,747 S 7/1991 Barker  
 5,035,009 A 7/1991 Wingo  
 D330,271 S 10/1992 Samples  
 5,177,815 A 1/1993 Andujar  
 5,271,103 A 12/1993 Darnell  
 5,324,460 A 6/1994 Briggs  
 D352,333 S 11/1994 Lieberman  
 5,361,410 A 11/1994 Sigl  
 5,361,420 A 11/1994 Dobbs  
 D355,508 S 2/1995 Tutton  
 D363,571 S 10/1995 Klose  
 D366,347 S 1/1996 Avey  
 D366,557 S 1/1996 Ashby  
 5,515,546 A 5/1996 Shifrin  
 5,537,687 A 7/1996 Garza  
 D378,236 S 2/1997 Zanotto  
 D378,624 S 3/1997 Chartrand  
 D382,370 S 8/1997 Comstock  
 D382,671 S \* 8/1997 Shewchenko ..... D29/102  
 D387,502 S 12/1997 Comstock  
 5,713,082 A 2/1998 Bassette  
 D401,018 S 11/1998 Chartrand  
 D412,376 S 7/1999 Jurga

D412,766 S 8/1999 Tang  
 5,930,841 A 8/1999 Lampe  
 D415,593 S 10/1999 Tang  
 6,073,271 A 6/2000 Alexander  
 6,088,840 A 7/2000 Im  
 D429,035 S 8/2000 Purnell  
 6,159,324 A 12/2000 Watters  
 D443,405 S 6/2001 Quiroz  
 D444,269 S 6/2001 Jeffreys  
 D445,962 S 7/2001 Brignone  
 6,266,827 B1 7/2001 Lampe  
 D448,890 S 10/2001 Brignone  
 D449,411 S 10/2001 Largeot  
 D453,056 S 1/2002 Garneau  
 D453,399 S 2/2002 Racine  
 6,389,607 B1 5/2002 Wood  
 D459,032 S 6/2002 Gatellet  
 D459,554 S 6/2002 Gatellet  
 D459,555 S 6/2002 Gatellet  
 D460,584 S 7/2002 Green  
 6,421,840 B1 7/2002 Chen  
 D461,152 S 8/2002 Schmitt  
 D465,067 S 10/2002 Ide et al.  
 D466,651 S 12/2002 Halstead et al.  
 D479,020 S 8/2003 Heinrich  
 6,625,820 B1 9/2003 Lampe  
 D482,163 S 11/2003 Brown  
 6,711,753 B2 \* 3/2004 Arai ..... A42B 3/222  
 2/424  
 D490,572 S 5/2004 Finquel  
 D495,093 S 8/2004 Tintera  
 D495,838 S \* 9/2004 Arai ..... D29/107  
 D498,334 S 11/2004 Durocher  
 D500,894 S 1/2005 Coutant  
 6,934,971 B2 8/2005 Ide  
 D509,928 S \* 9/2005 Barnoski ..... D29/107  
 D511,026 S \* 10/2005 Ide ..... D29/107  
 D512,534 S 12/2005 Maddux et al.  
 D528,705 S 9/2006 Ide  
 D529,233 S 9/2006 Schneider  
 D541,480 S 4/2007 Turner  
 D545,501 S 6/2007 Green  
 D556,951 S 12/2007 Gath  
 D567,455 S 4/2008 Rogers  
 D581,599 S \* 11/2008 Ferrara ..... D29/106  
 D582,607 S \* 12/2008 Ferrara ..... D29/106  
 D583,507 S 12/2008 Stingone  
 D587,407 S 2/2009 Nimmons  
 D587,852 S 3/2009 Nimmons  
 D587,853 S 3/2009 Nimmons  
 D587,854 S 3/2009 Nimmons  
 D587,855 S 3/2009 Nimmons  
 D592,809 S 5/2009 Broersma  
 D603,099 S 10/2009 Bologna  
 D603,100 S 10/2009 Bologna  
 D625,050 S 10/2010 Chen  
 D628,121 S 11/2010 Reilly  
 D628,347 S 11/2010 Chen  
 D629,162 S 12/2010 Daniel  
 D634,896 S 3/2011 Weber  
 D636,536 S 4/2011 Lee  
 D636,941 S 4/2011 Pye  
 D645,210 S 9/2011 Chilson  
 8,015,624 B2 9/2011 Baldackin  
 D651,355 S 12/2011 Schwabe  
 D654,629 S 2/2012 Chou  
 D654,630 S 2/2012 Chou et al.  
 D654,632 S 2/2012 Chou  
 D665,132 S 8/2012 Shook  
 D665,154 S 8/2012 Richards  
 D666,775 S 9/2012 Junker  
 D669,225 S 10/2012 Woxing  
 D670,447 S 11/2012 Emrich  
 D671,687 S 11/2012 Winningham  
 D677,006 S 2/2013 Pfanner  
 D678,617 S 3/2013 Erb et al.  
 D679,867 S 4/2013 Jones  
 D680,275 S 4/2013 Janetos  
 D681,280 S 4/2013 Bologna



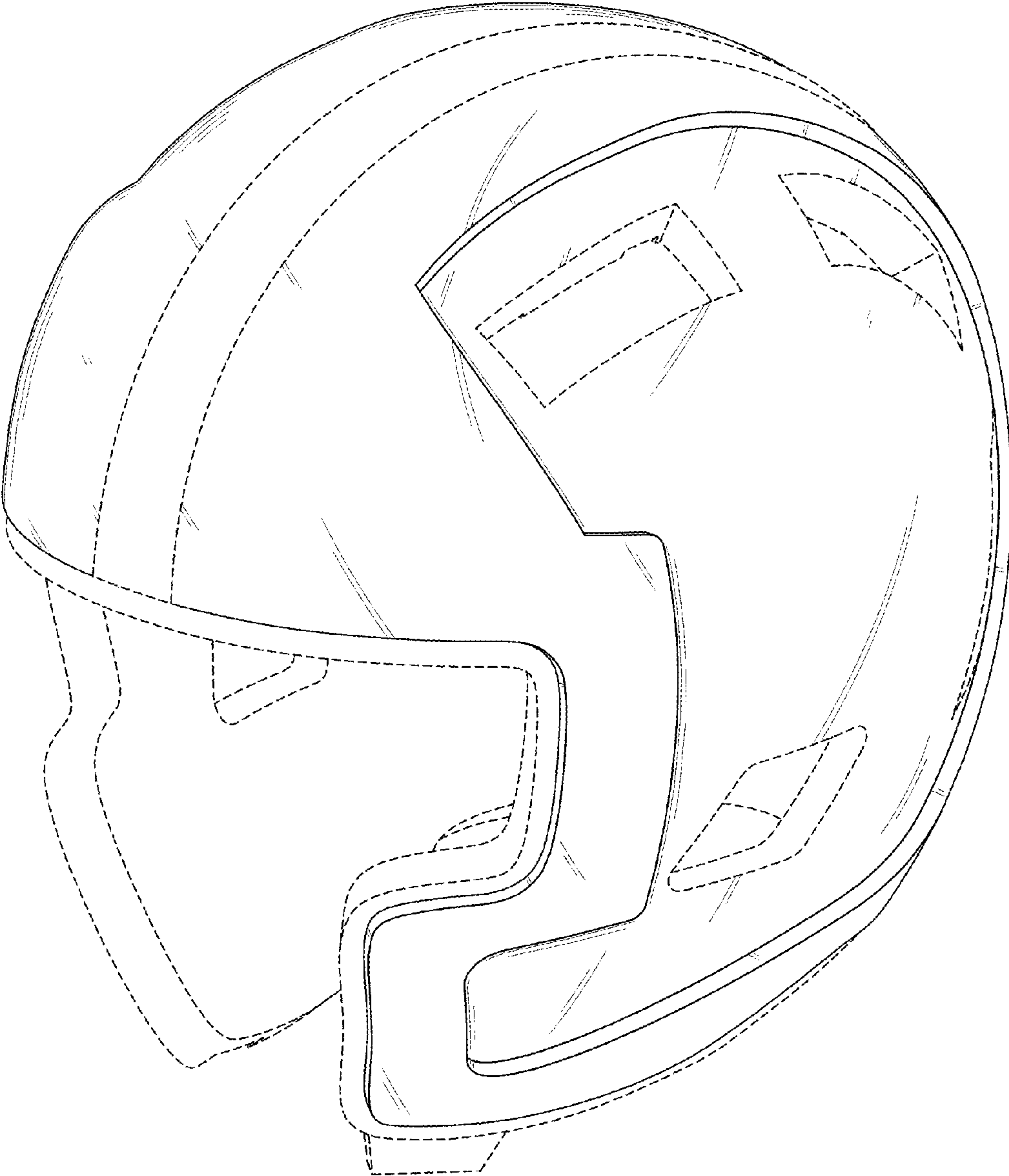
(56)

**References Cited**

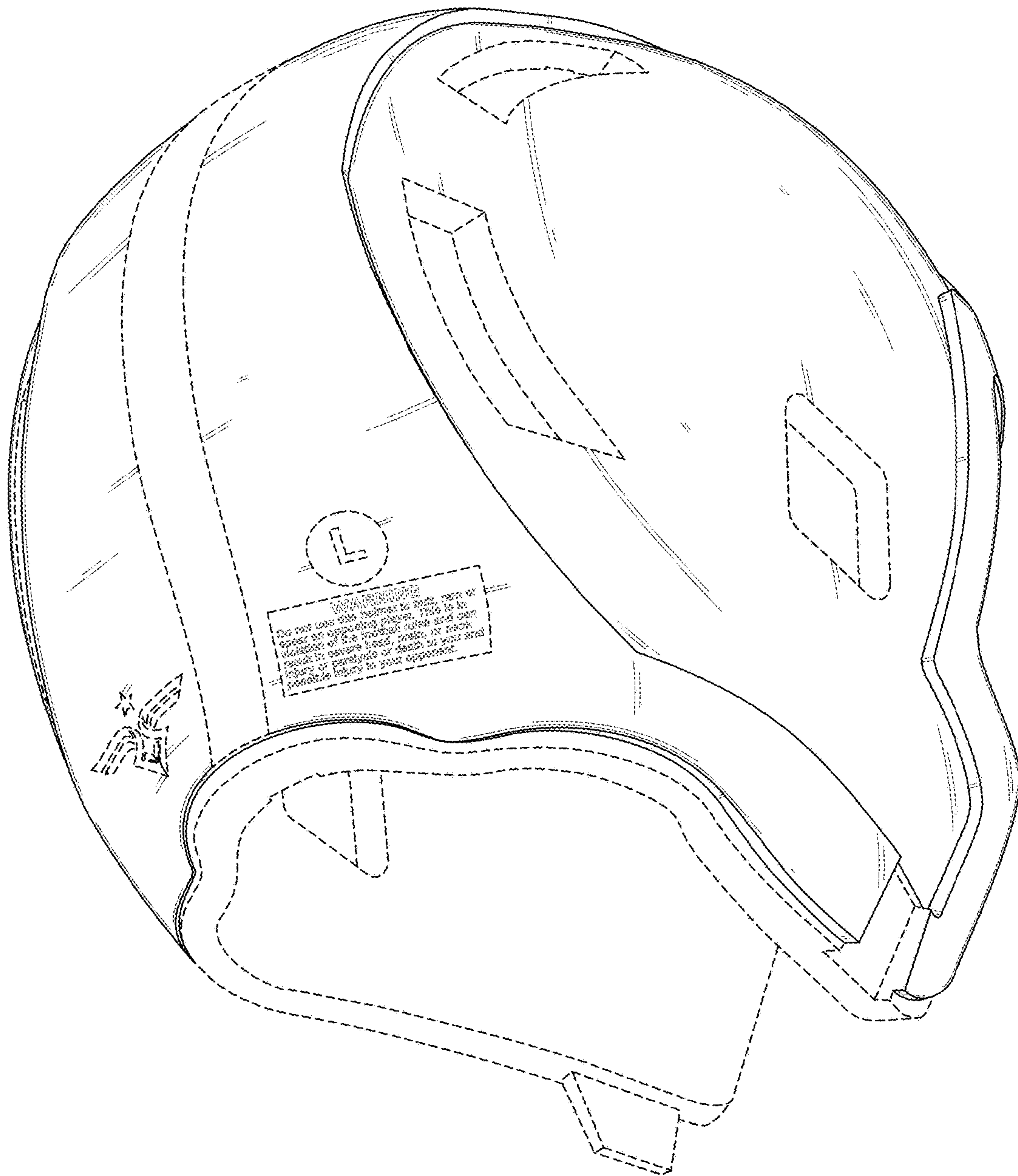
U.S. PATENT DOCUMENTS

D681,281	S	4/2013	Bologna et al.	
8,499,366	B2	8/2013	Nimmons et al.	
D696,465	S	12/2013	Hwang	
D697,270	S	1/2014	Simpson	
D708,395	S	7/2014	LaRocque	
8,973,172	B2 *	3/2015	Daniel .....	A42B 3/166 2/410
2012/0297525	A1	11/2012	Bain	
2013/0014313	A1	1/2013	Erb	
2013/0042396	A1	2/2013	Wehtje	

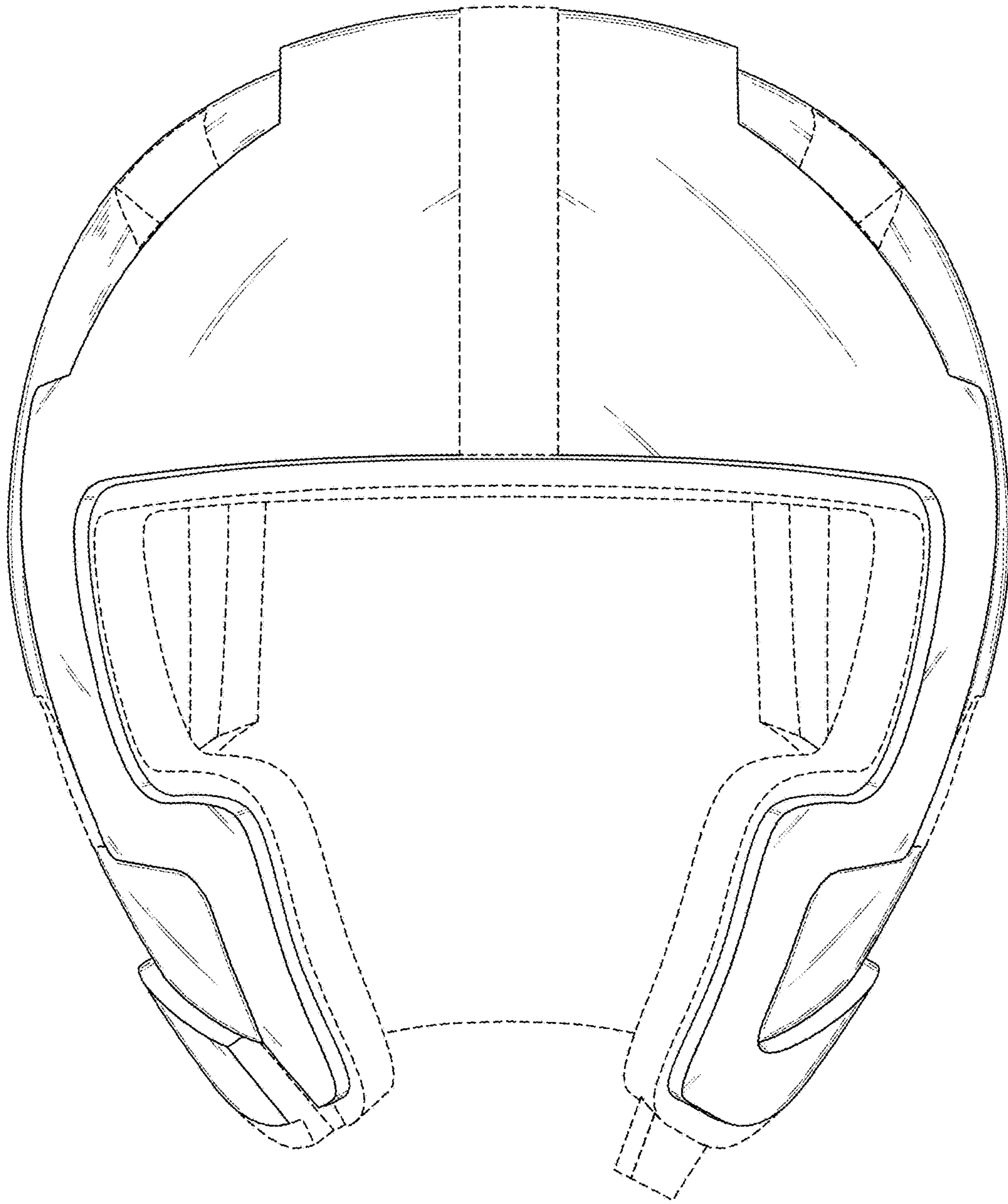
\* cited by examiner



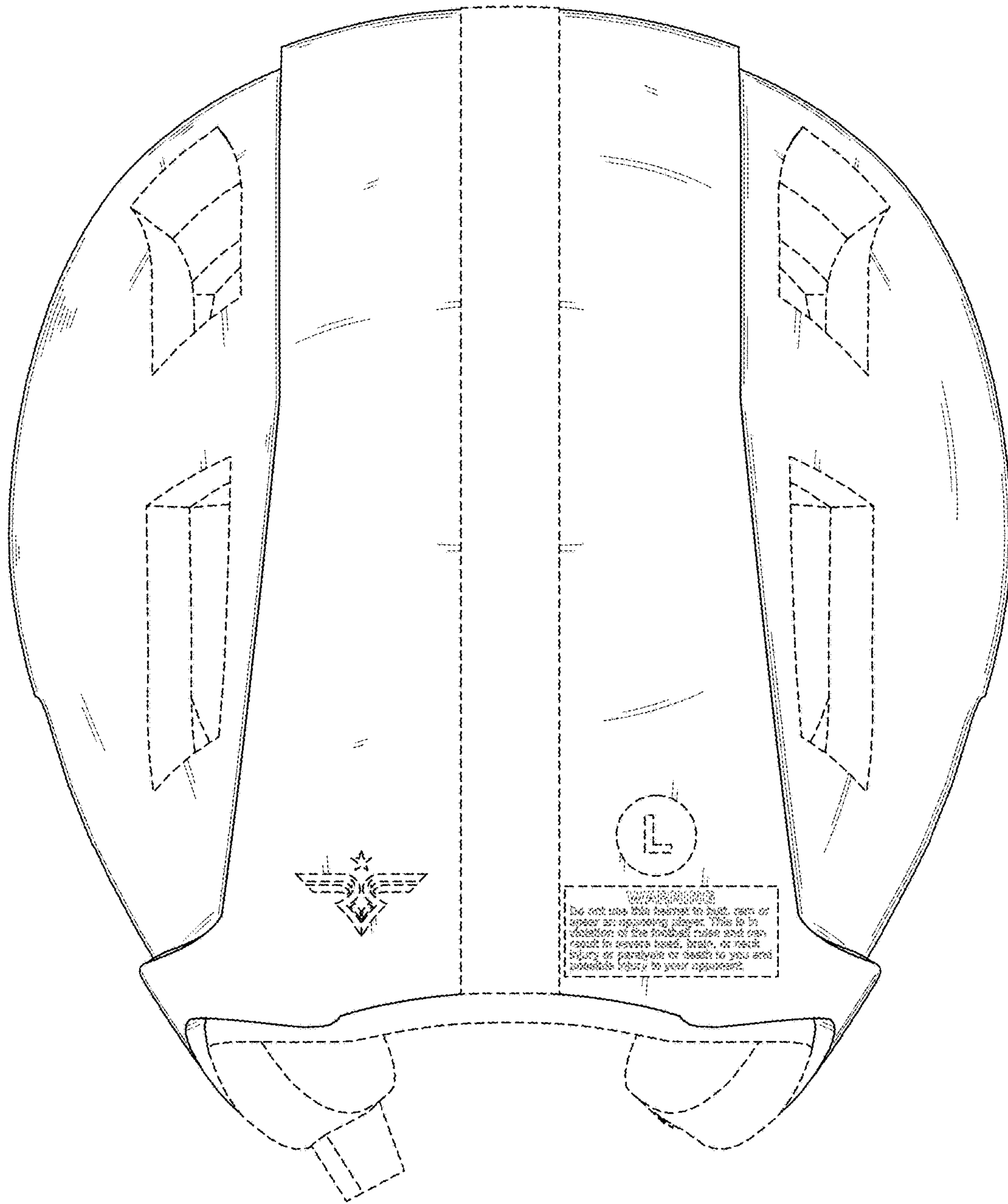
**FIG. 1**



**FIG. 2**

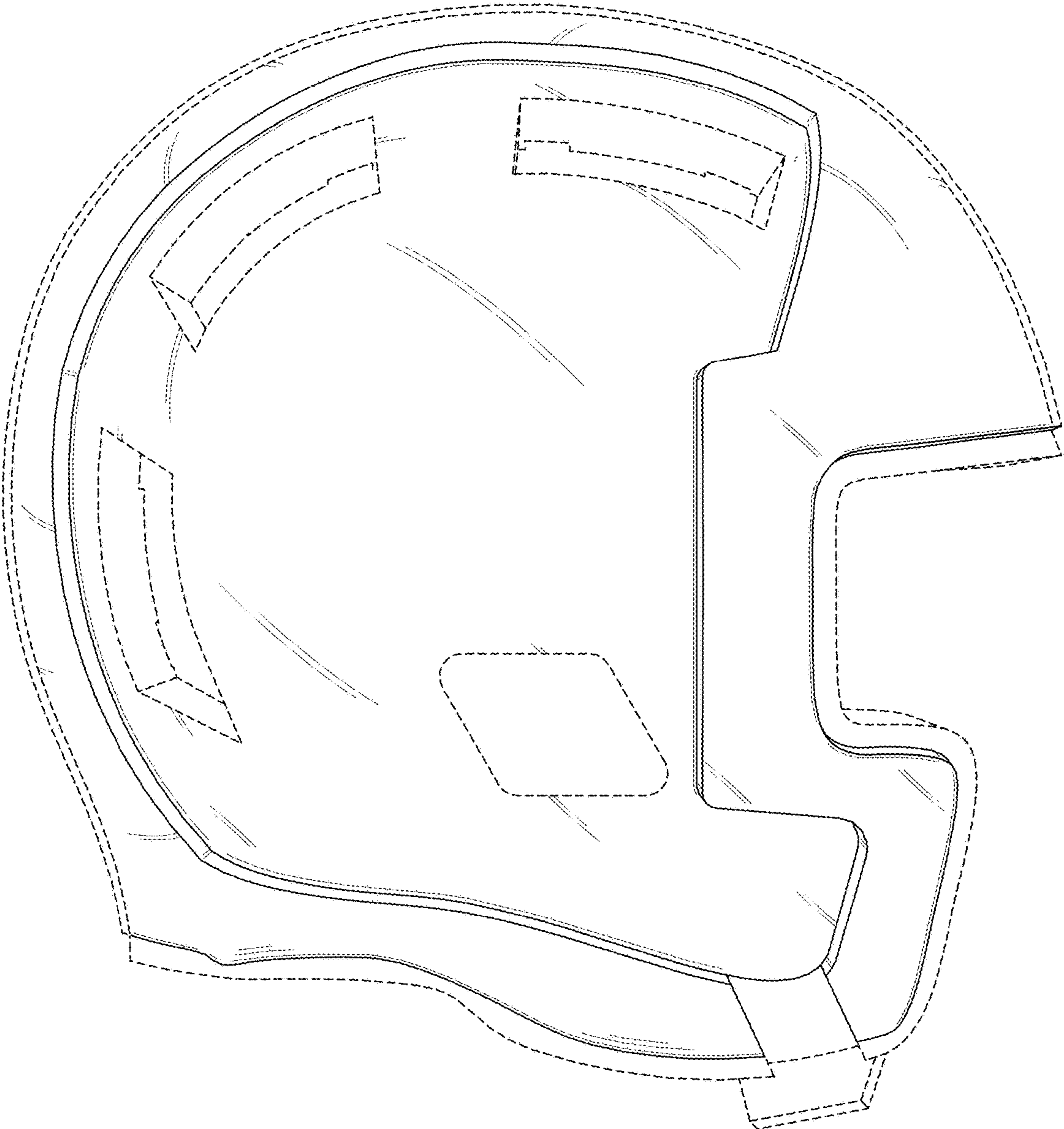


**FIG. 3**



**FIG. 4**





**FIG. 5**



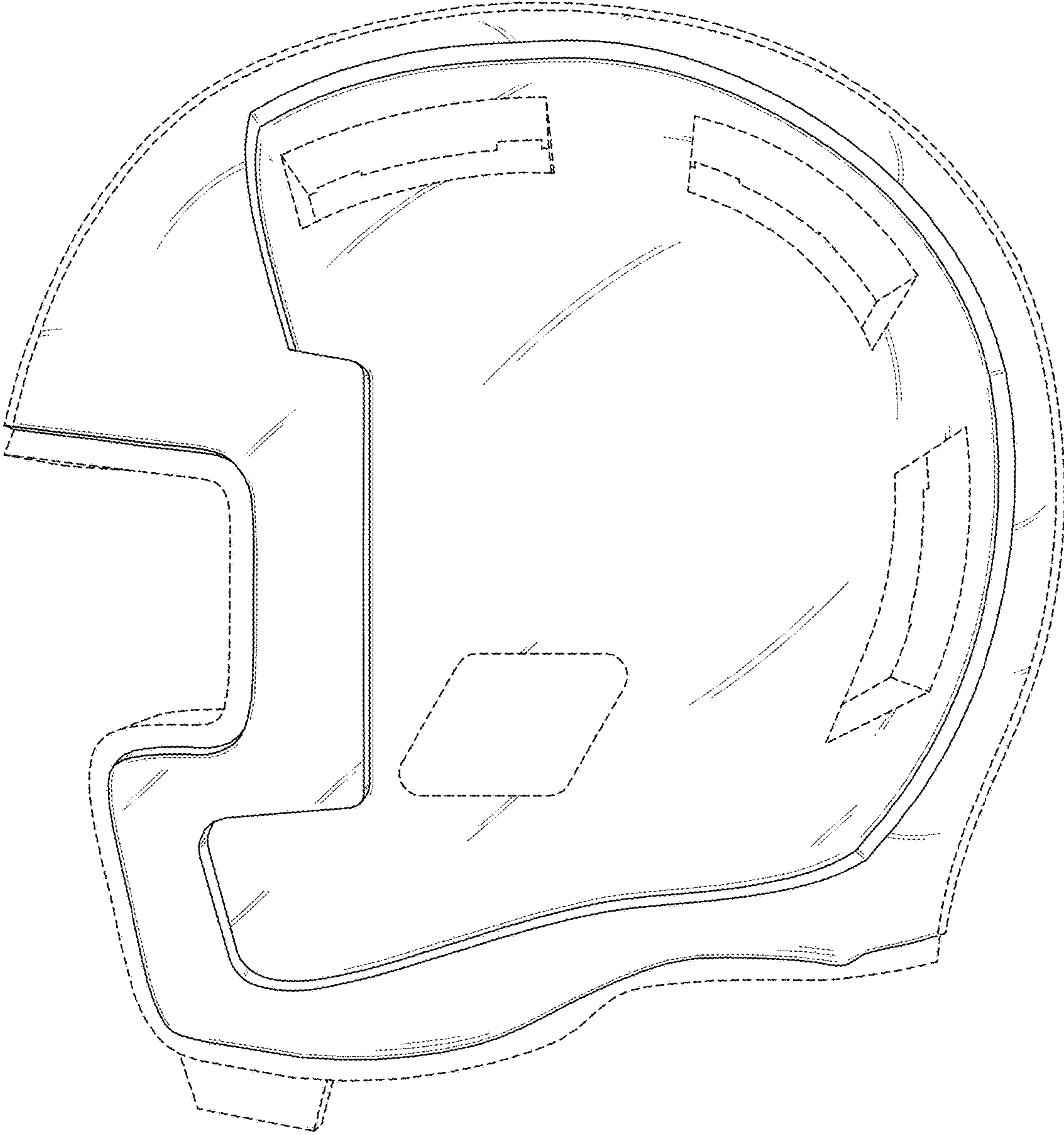


FIG. 6

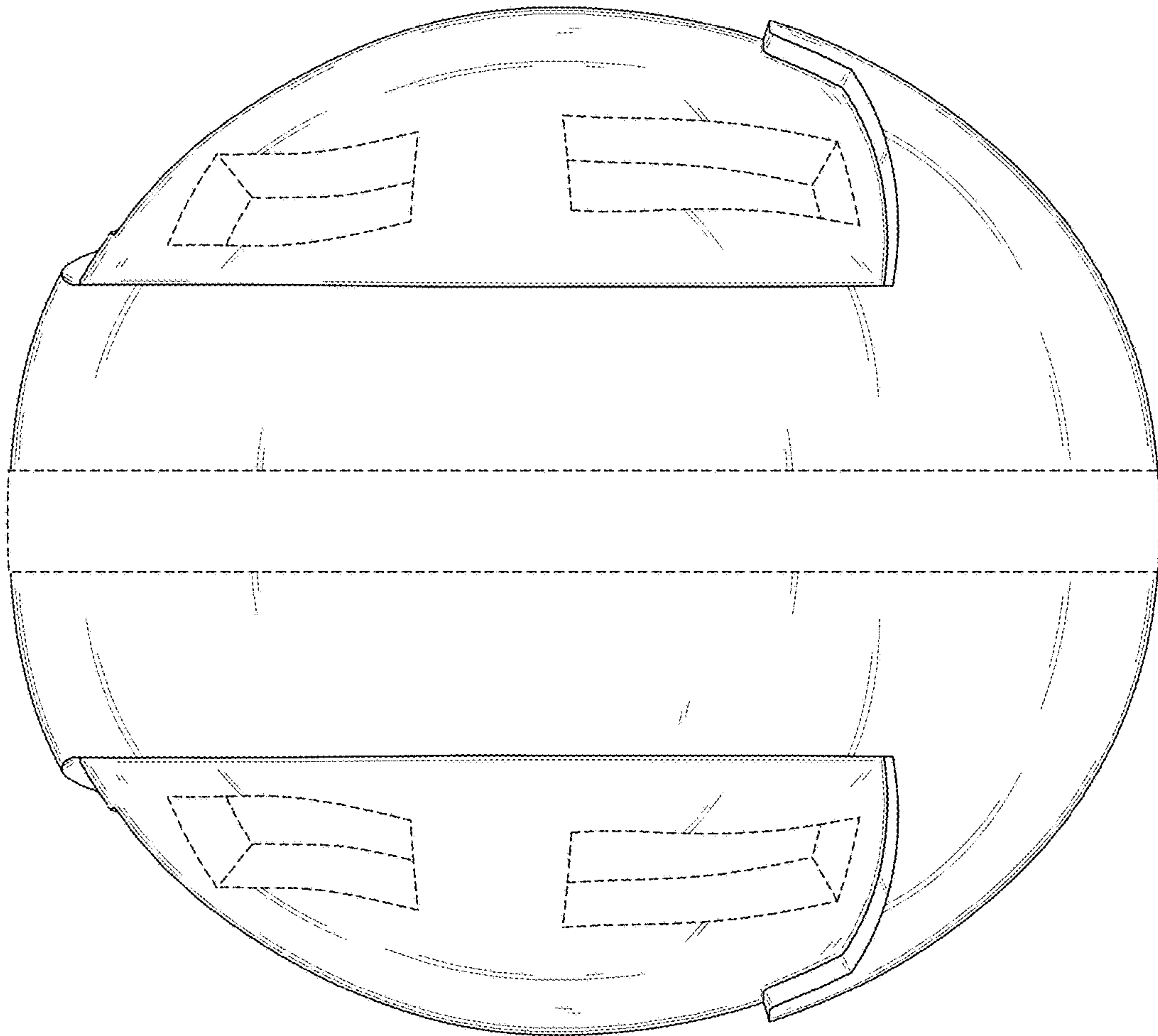


FIG. 7

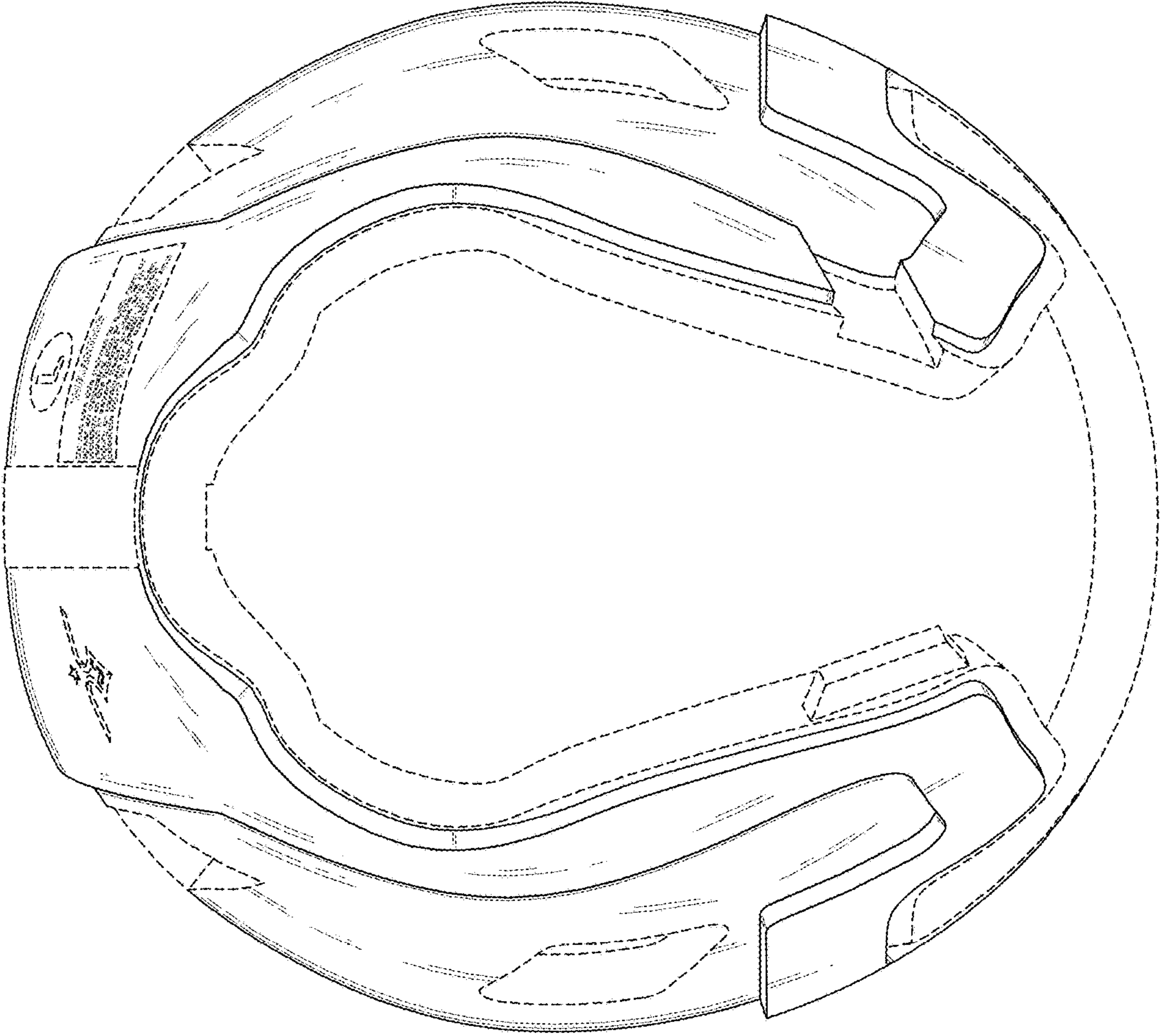
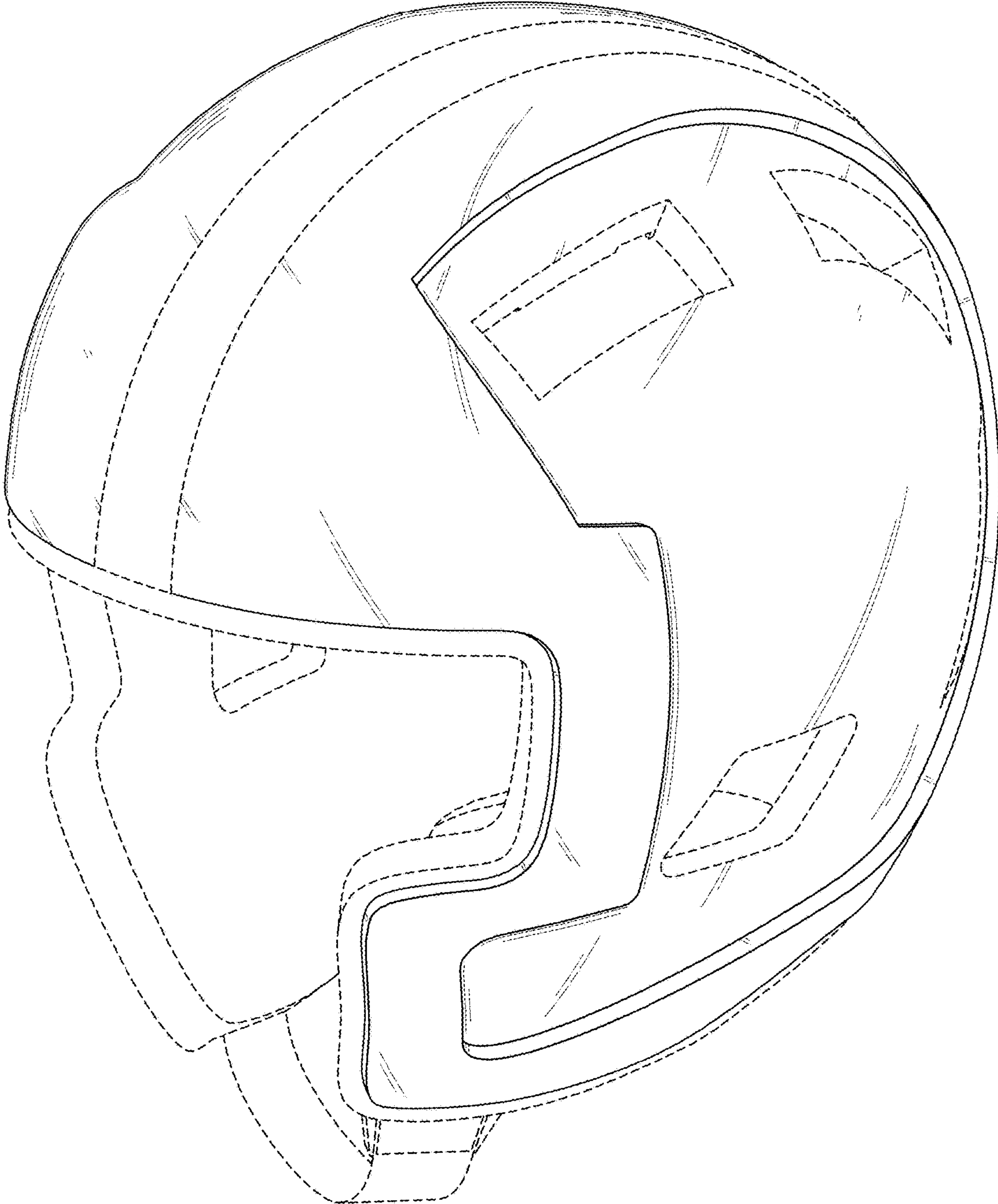


FIG. 8





**FIG. 9**

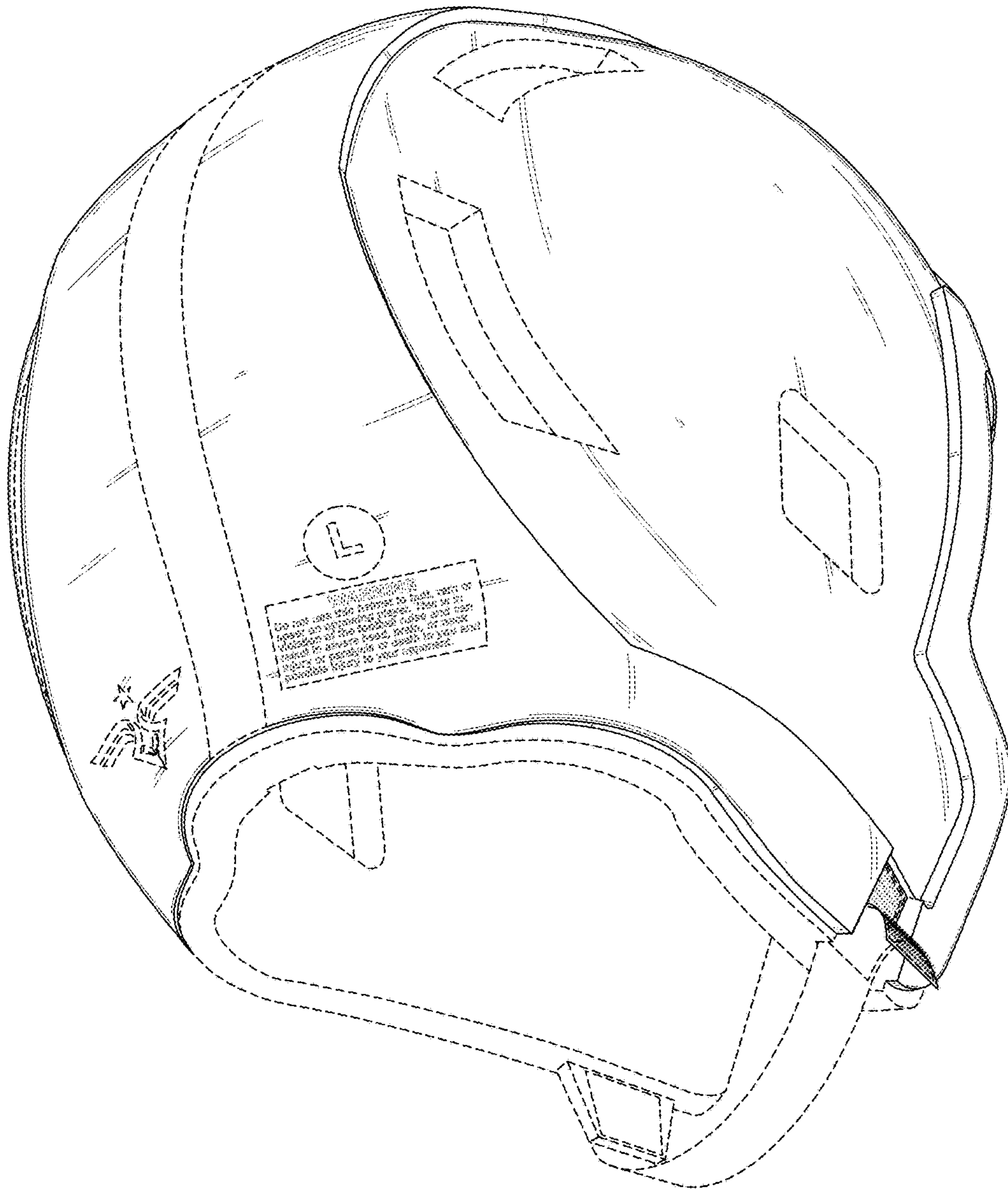


FIG. 10

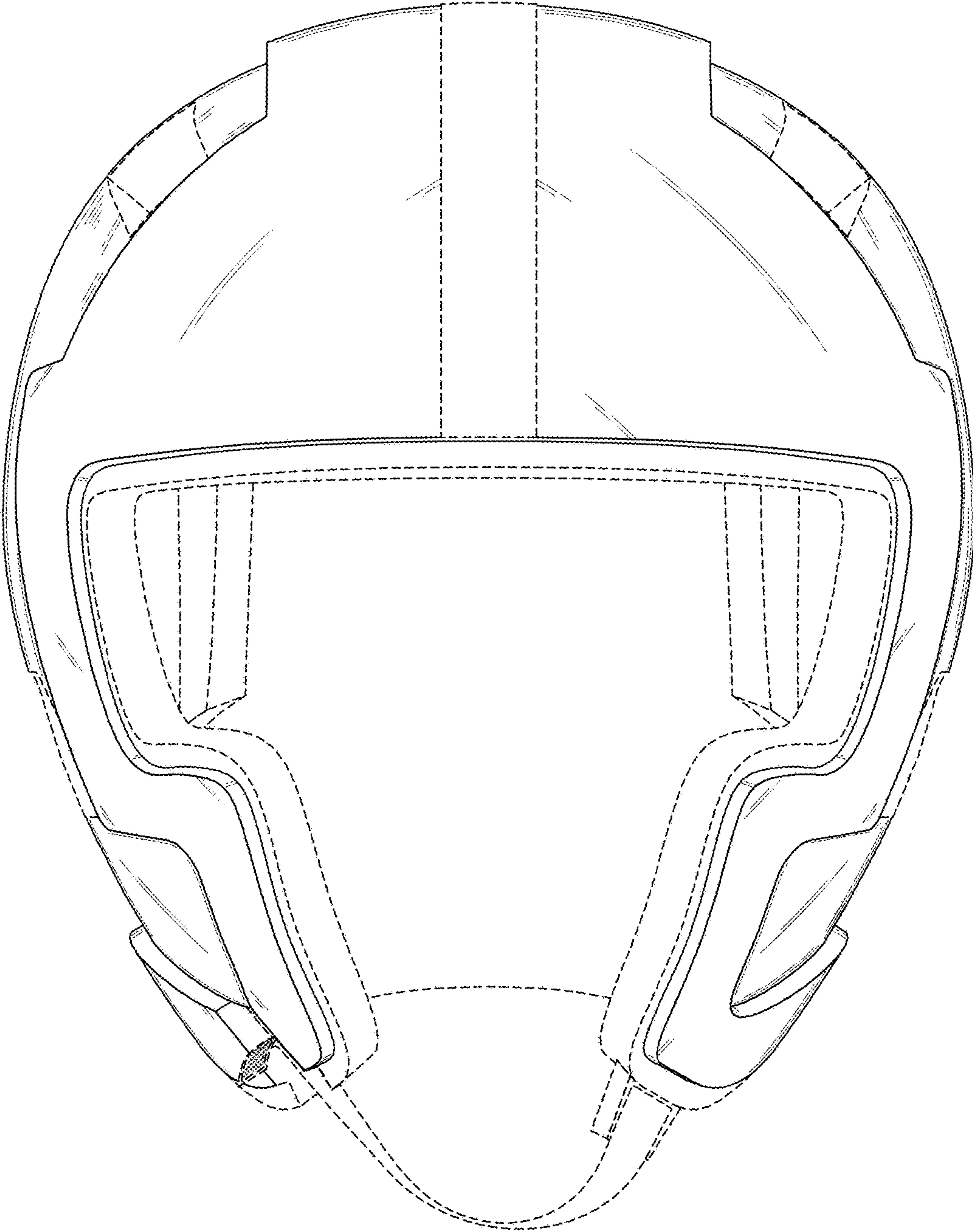


FIG. 11



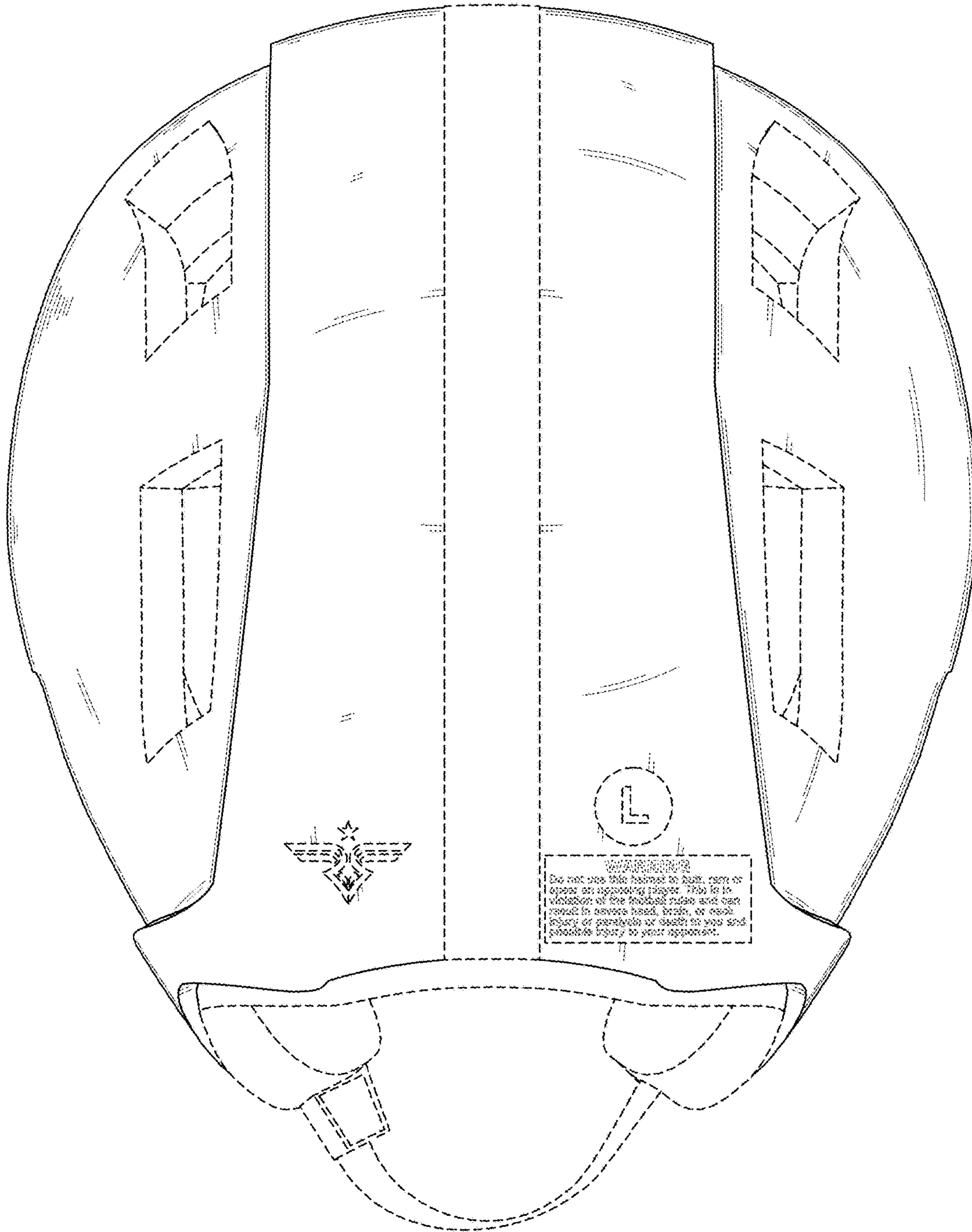
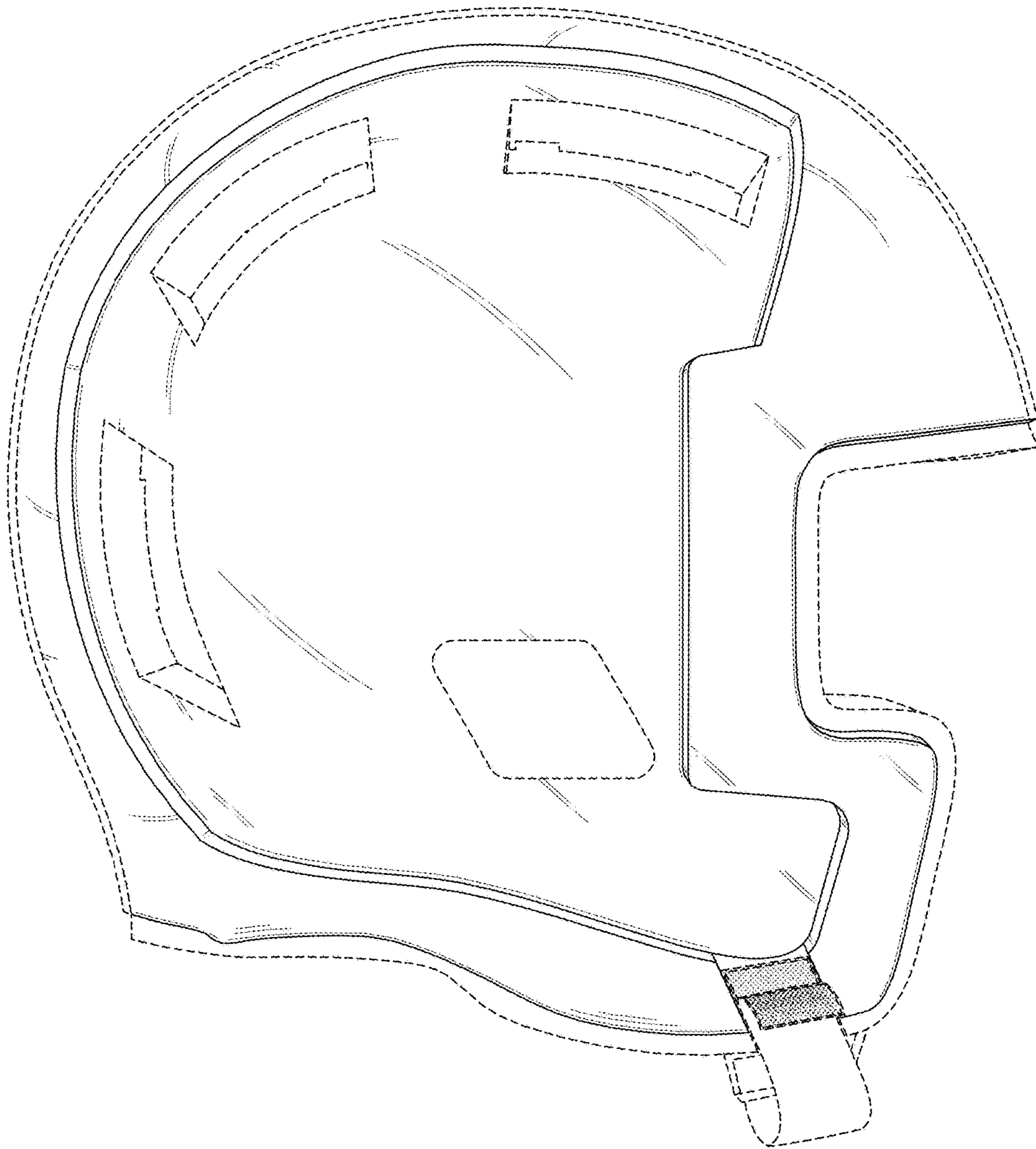


FIG. 12



**FIG. 13**

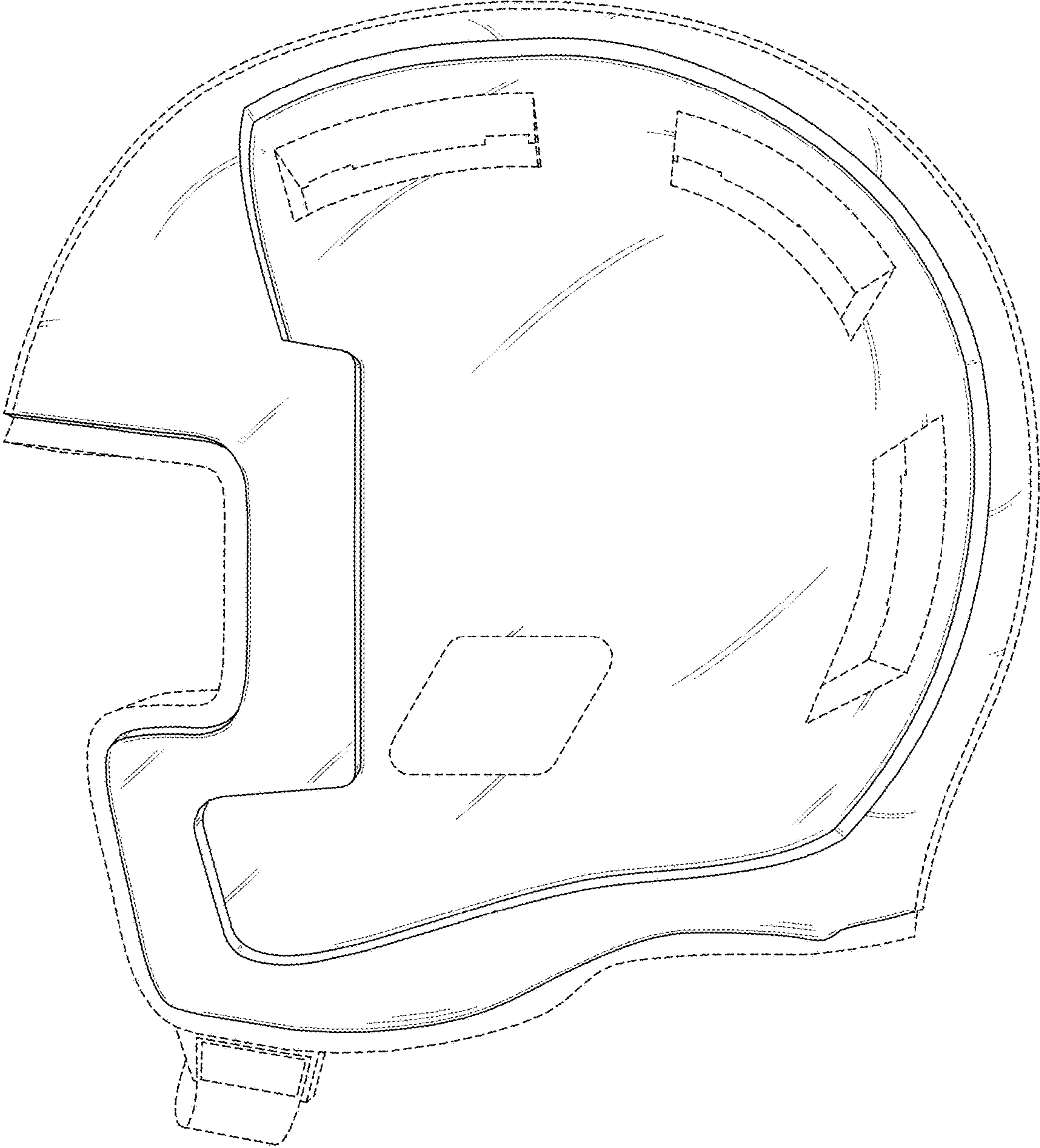


FIG. 14



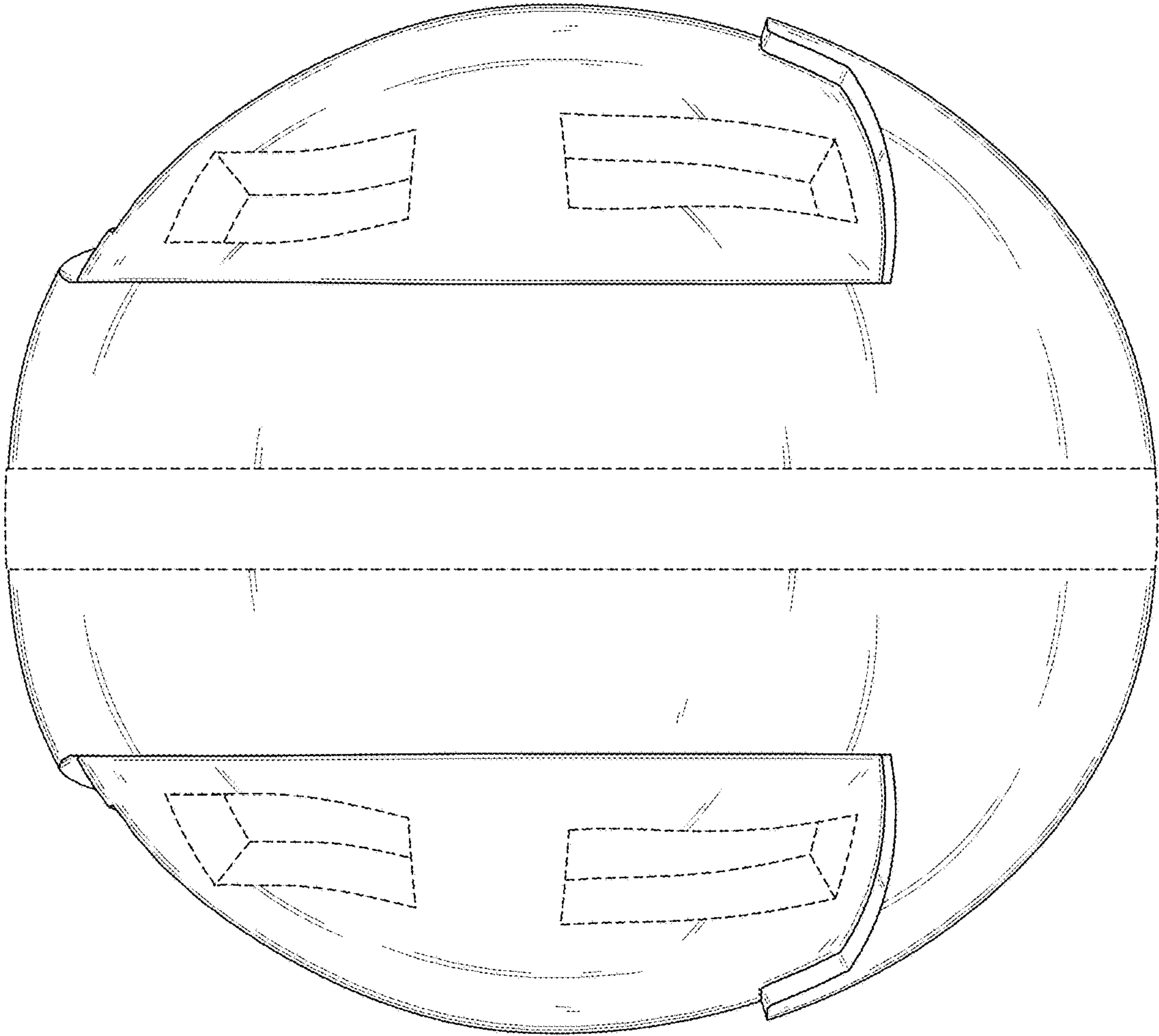
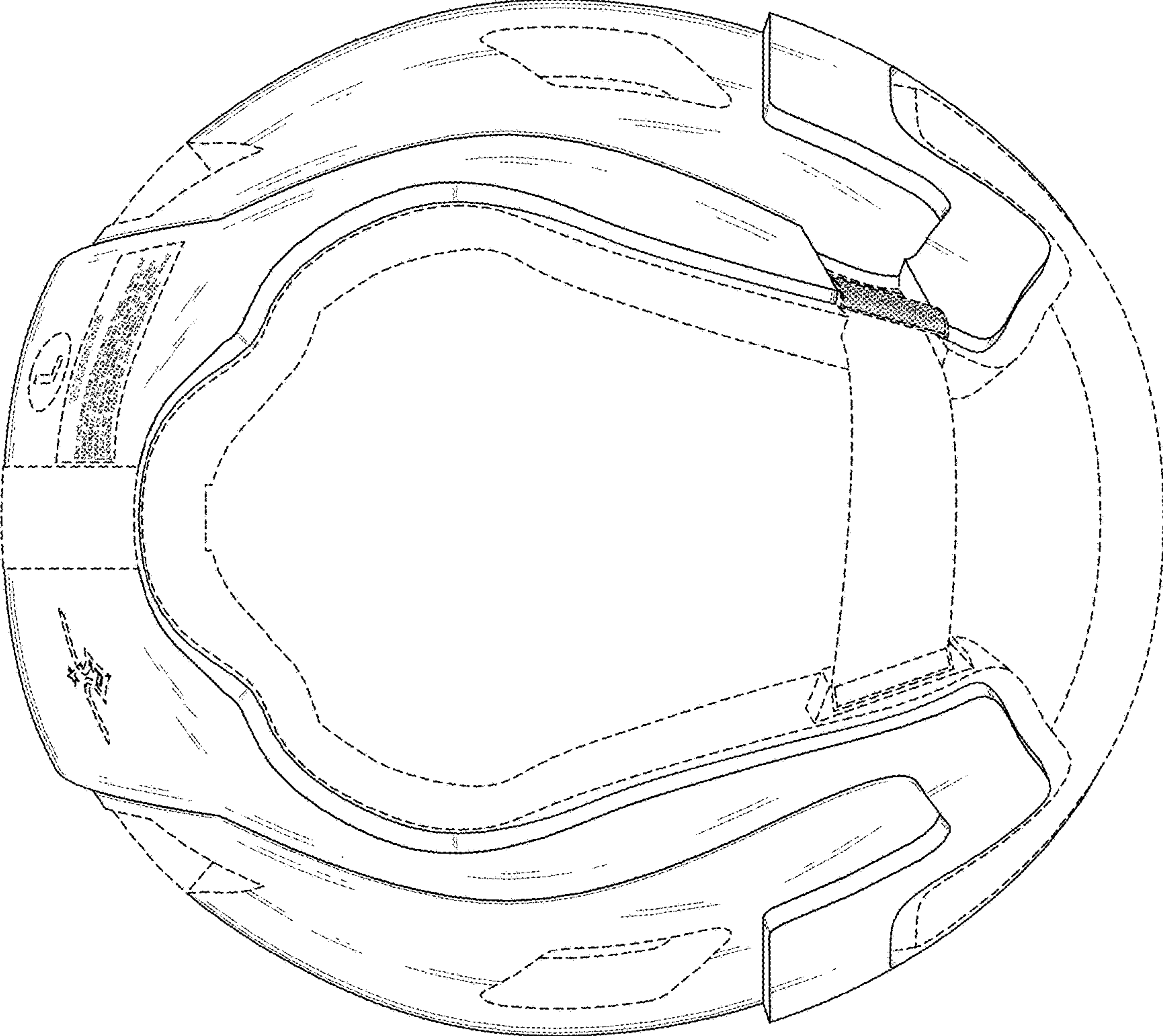
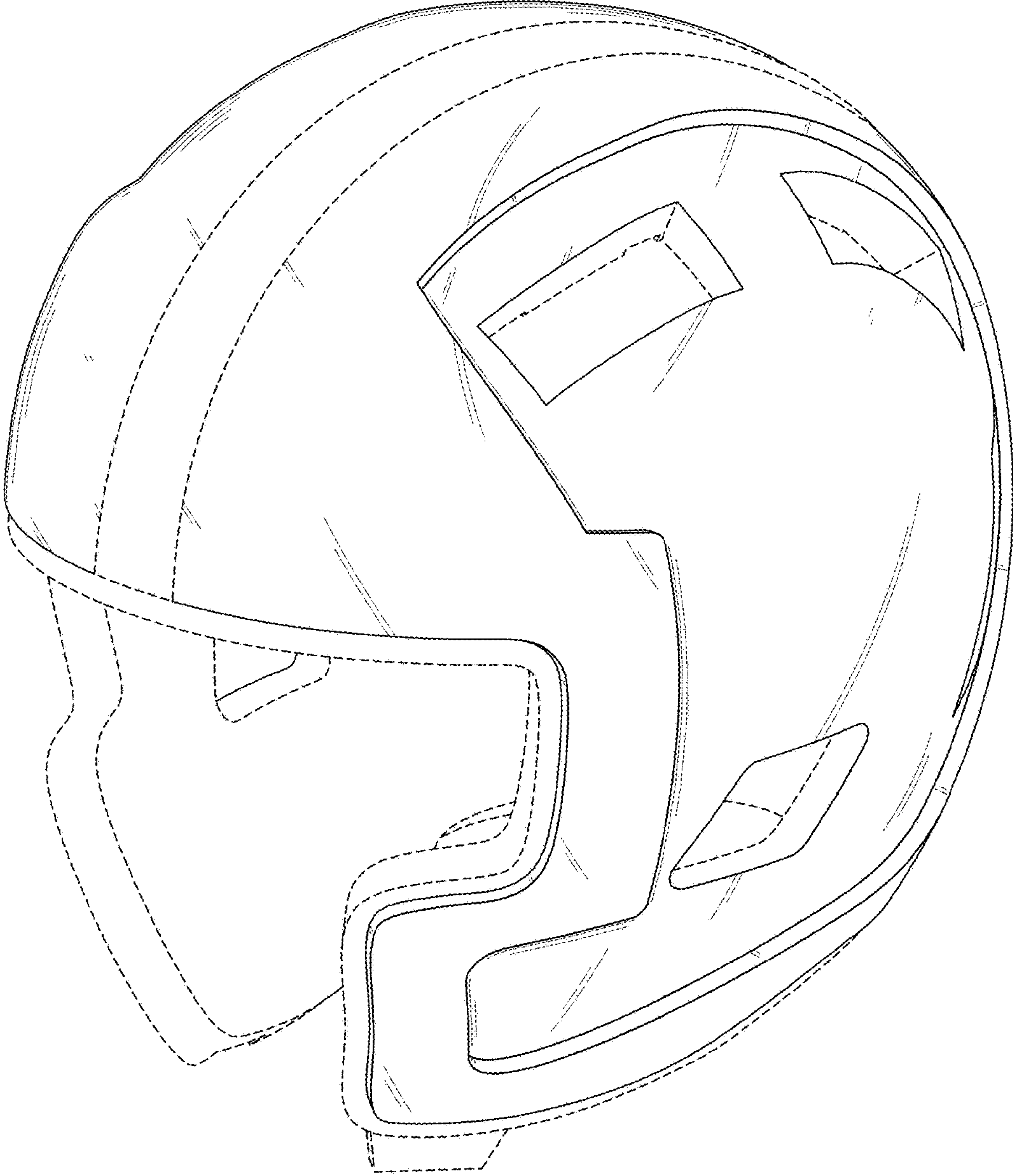


FIG. 15



**FIG. 16**



**FIG. 17**



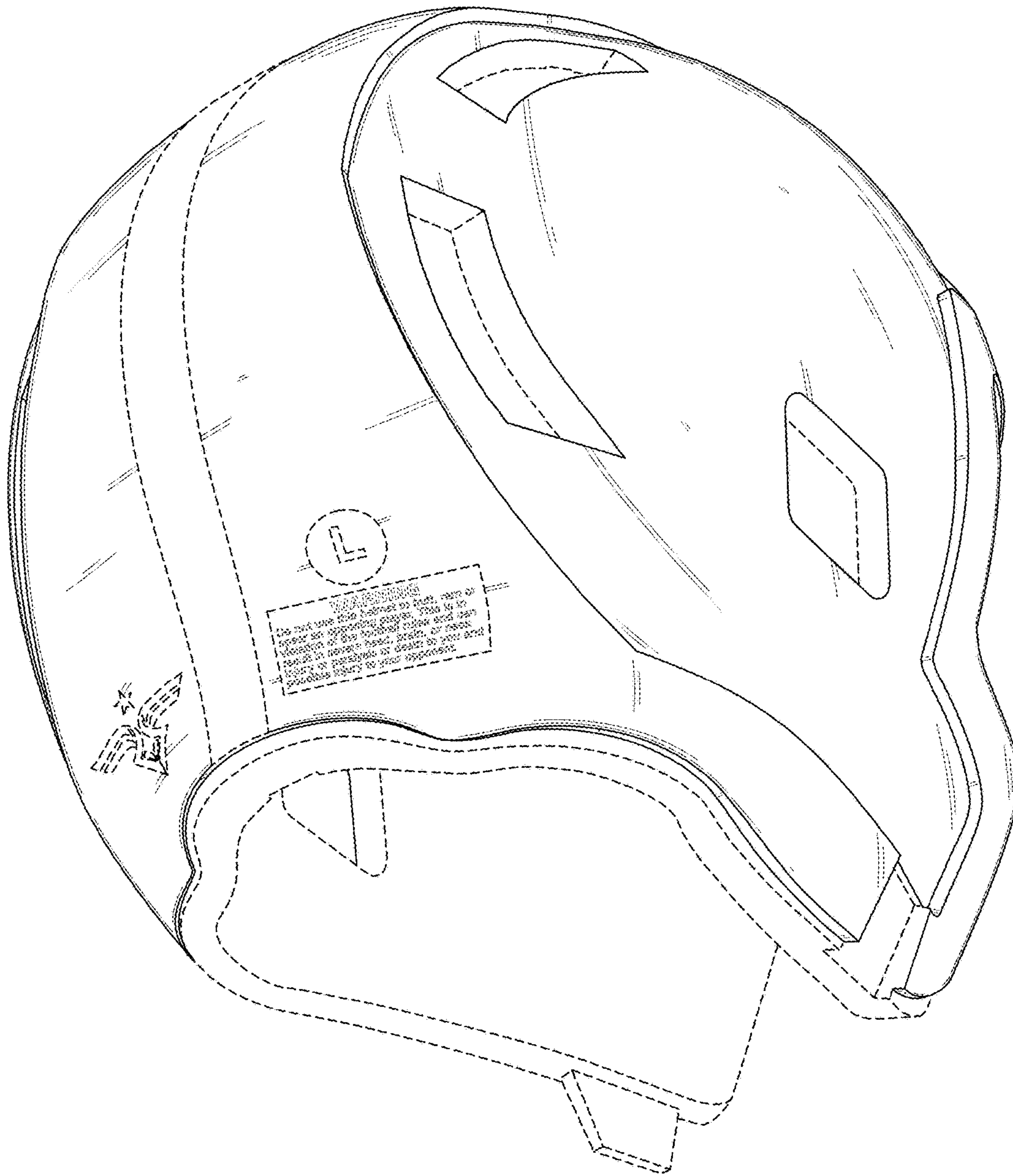
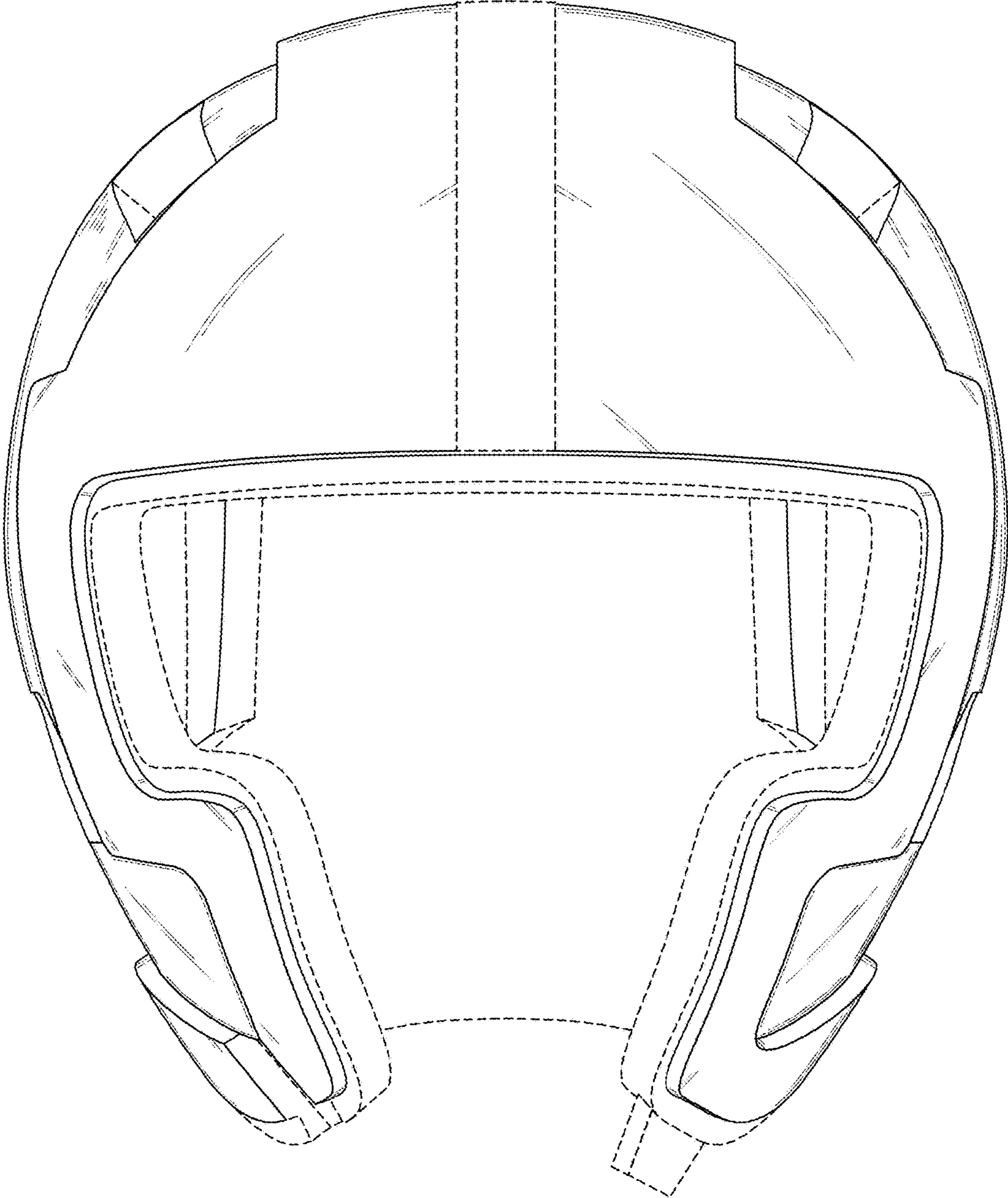


FIG. 18



**FIG. 19**

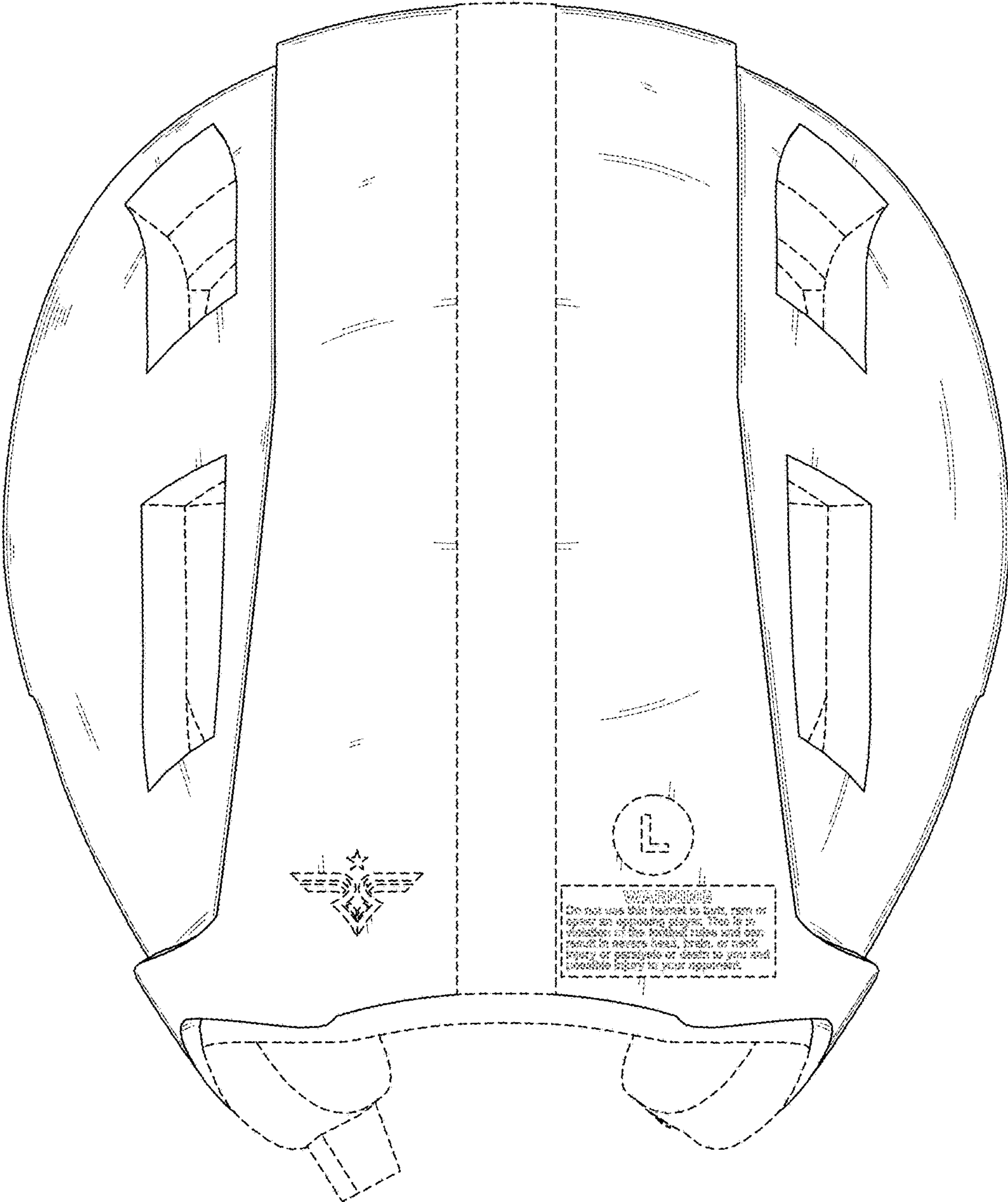


FIG. 20

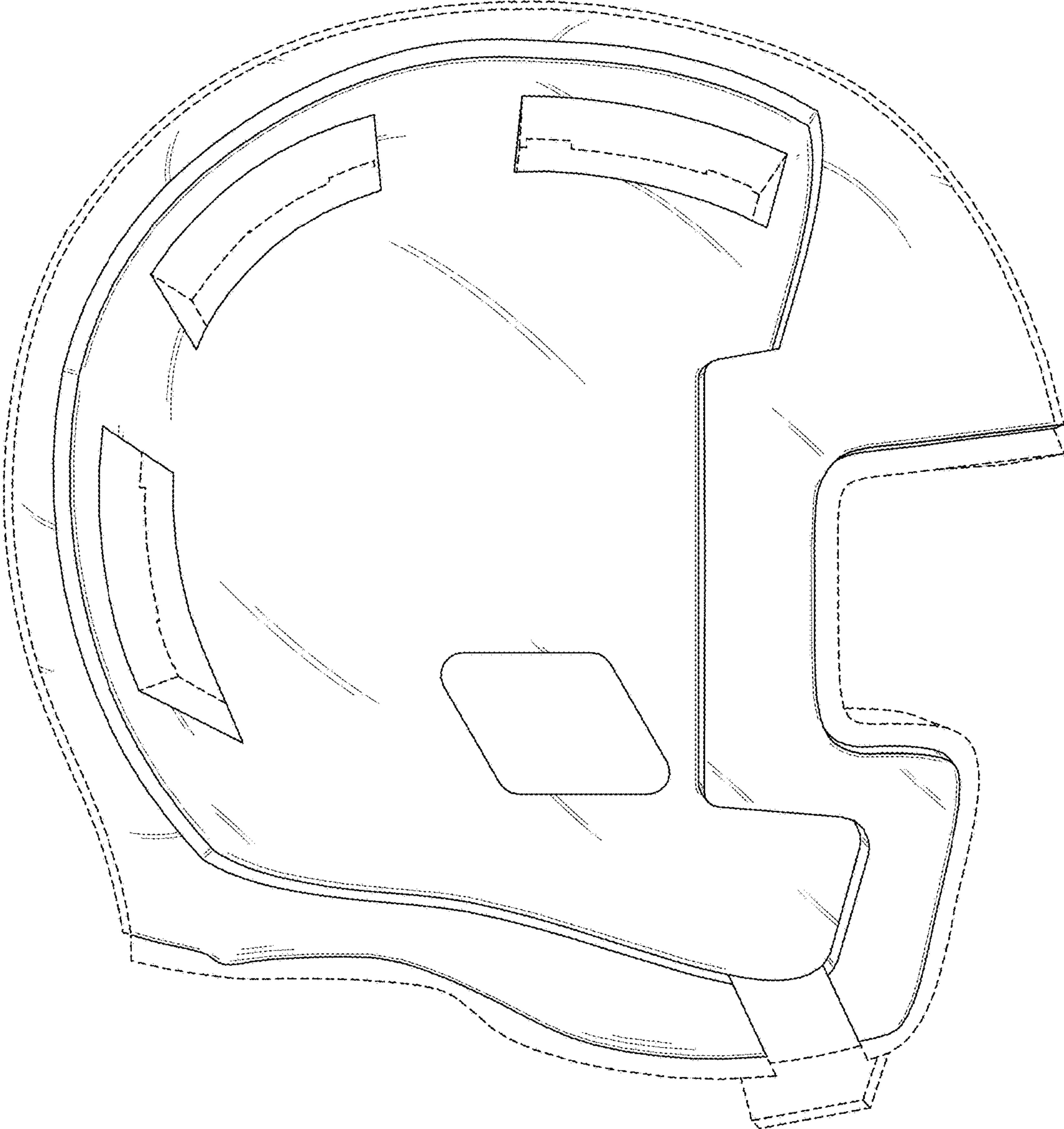


FIG. 21



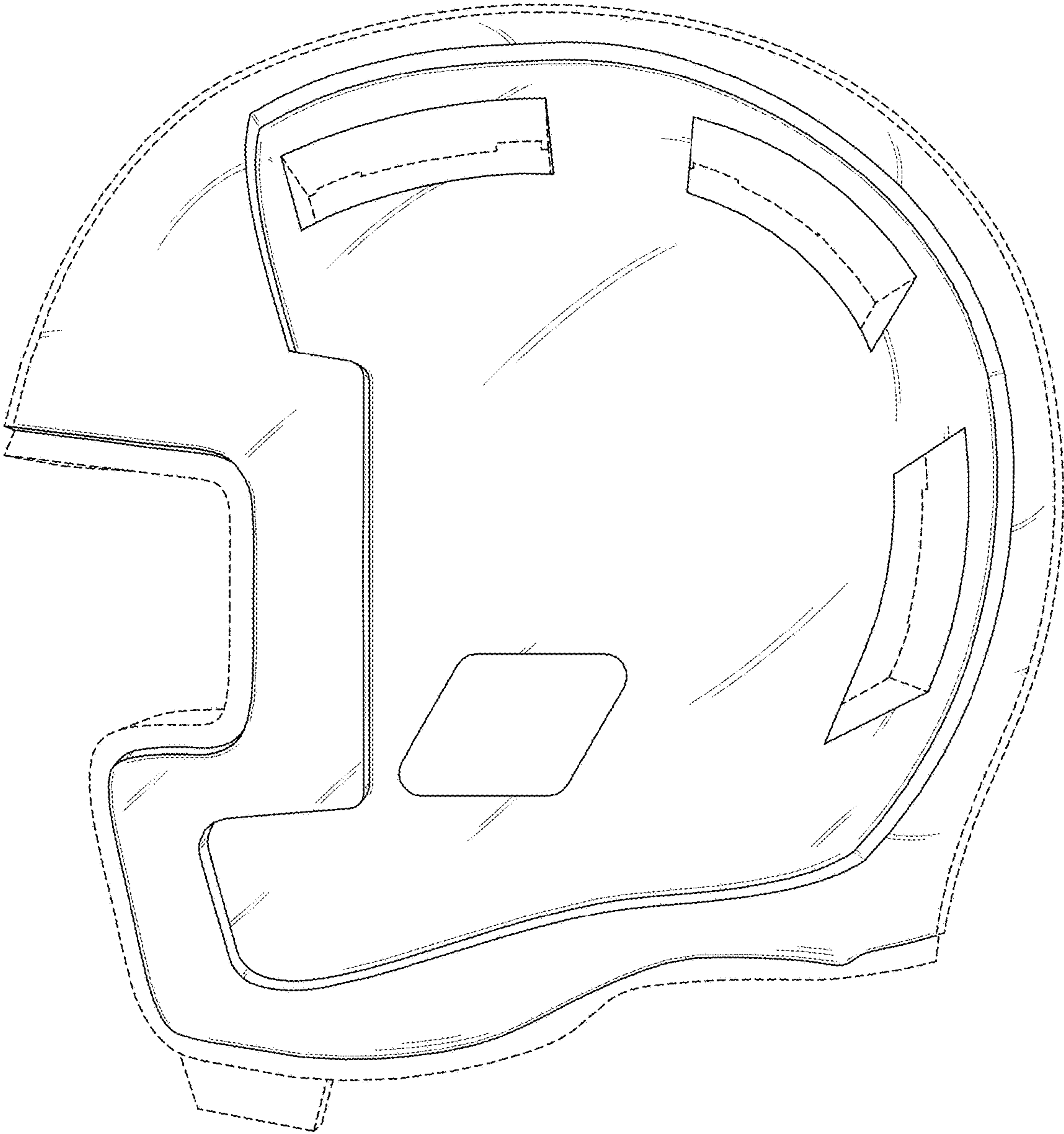


FIG. 22

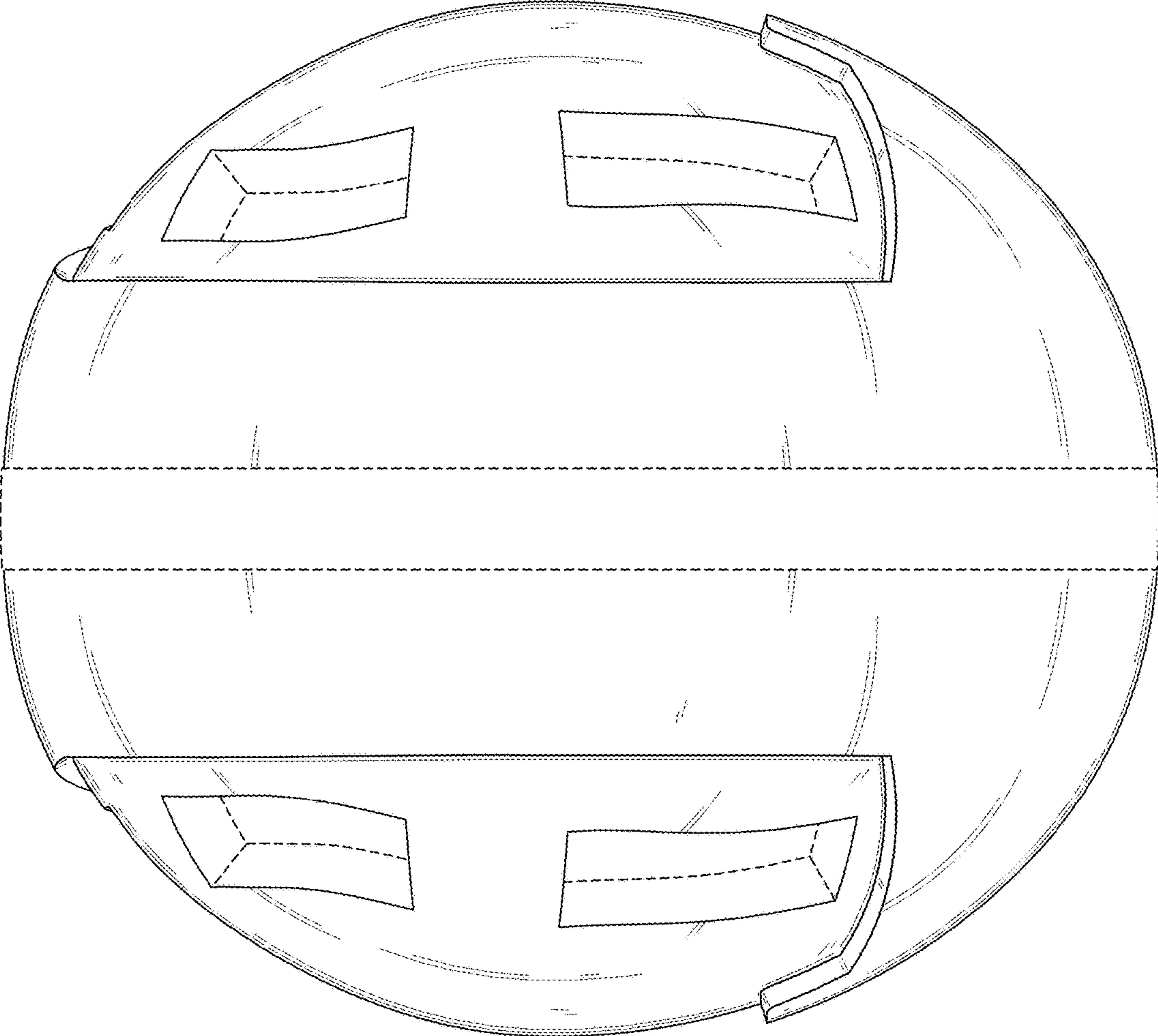


FIG. 23

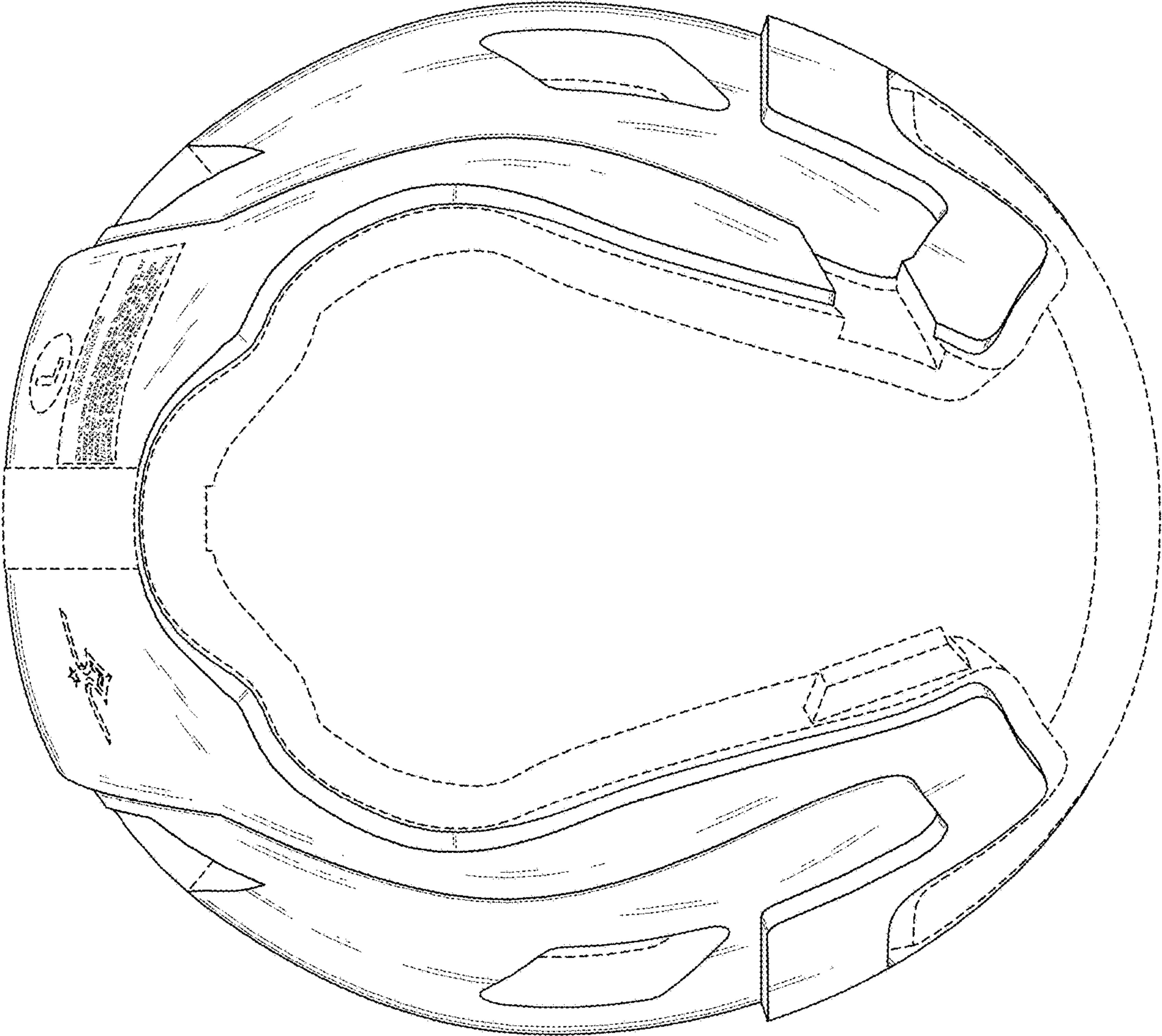
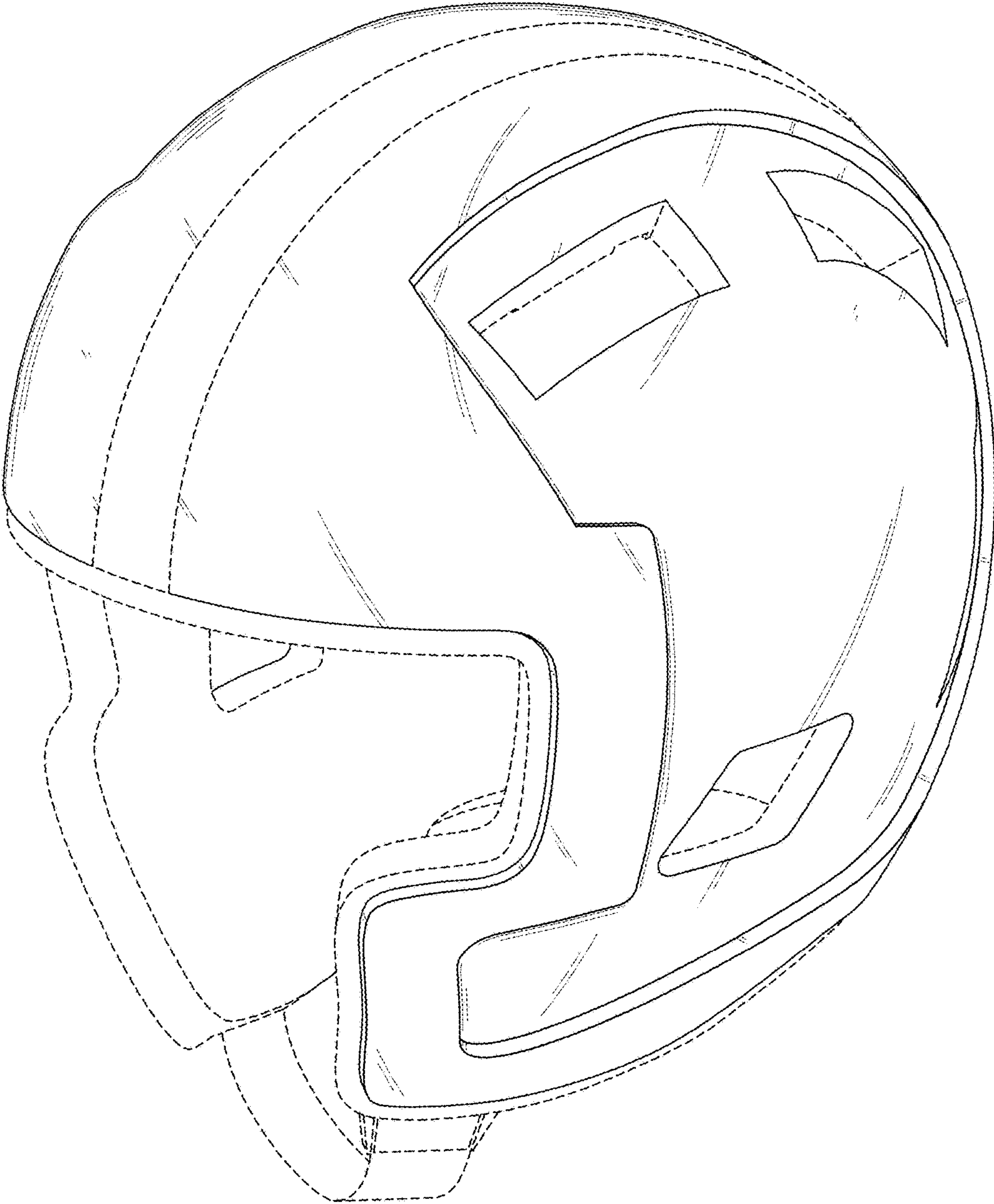


FIG. 24



**FIG. 25**



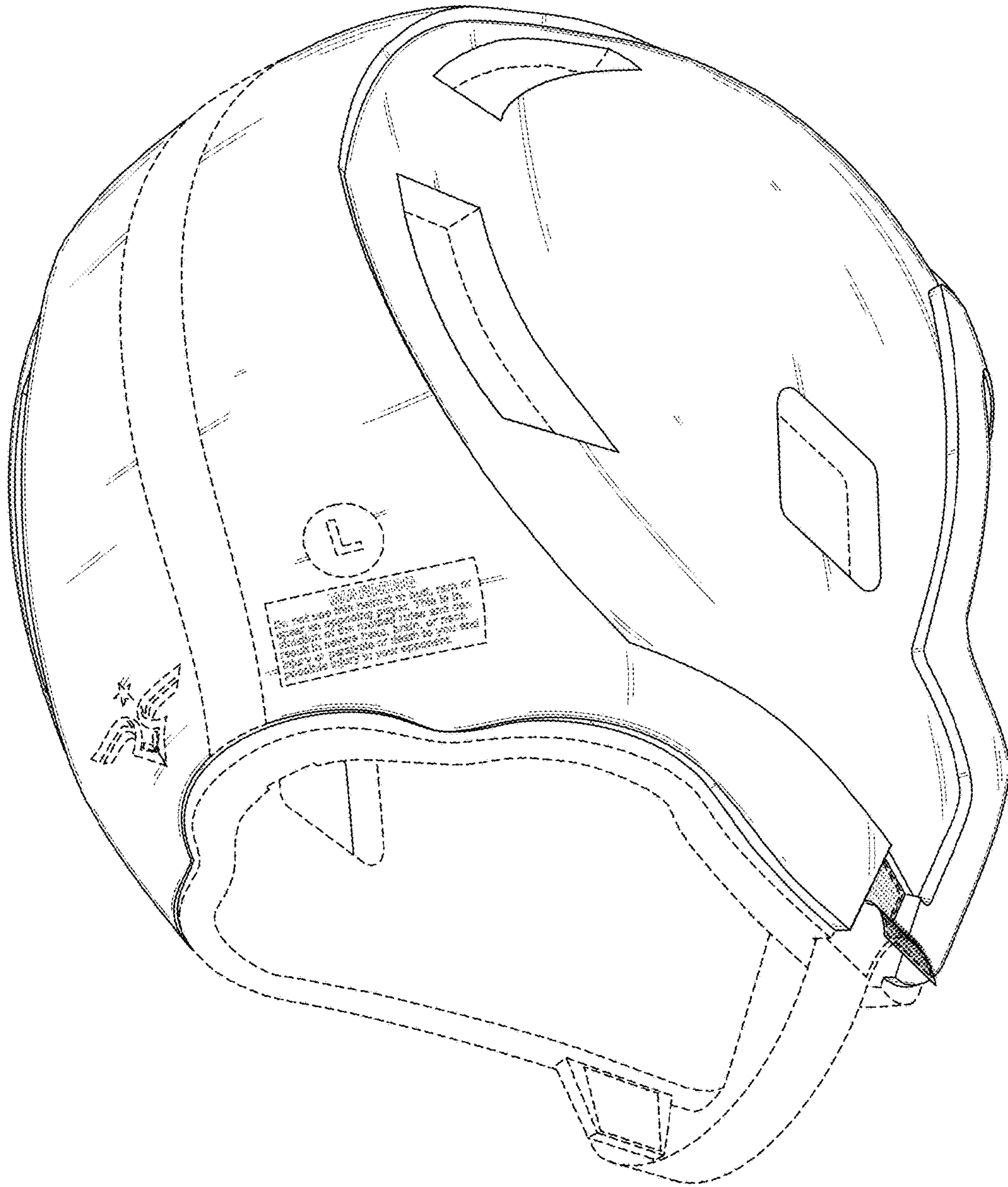


FIG. 26

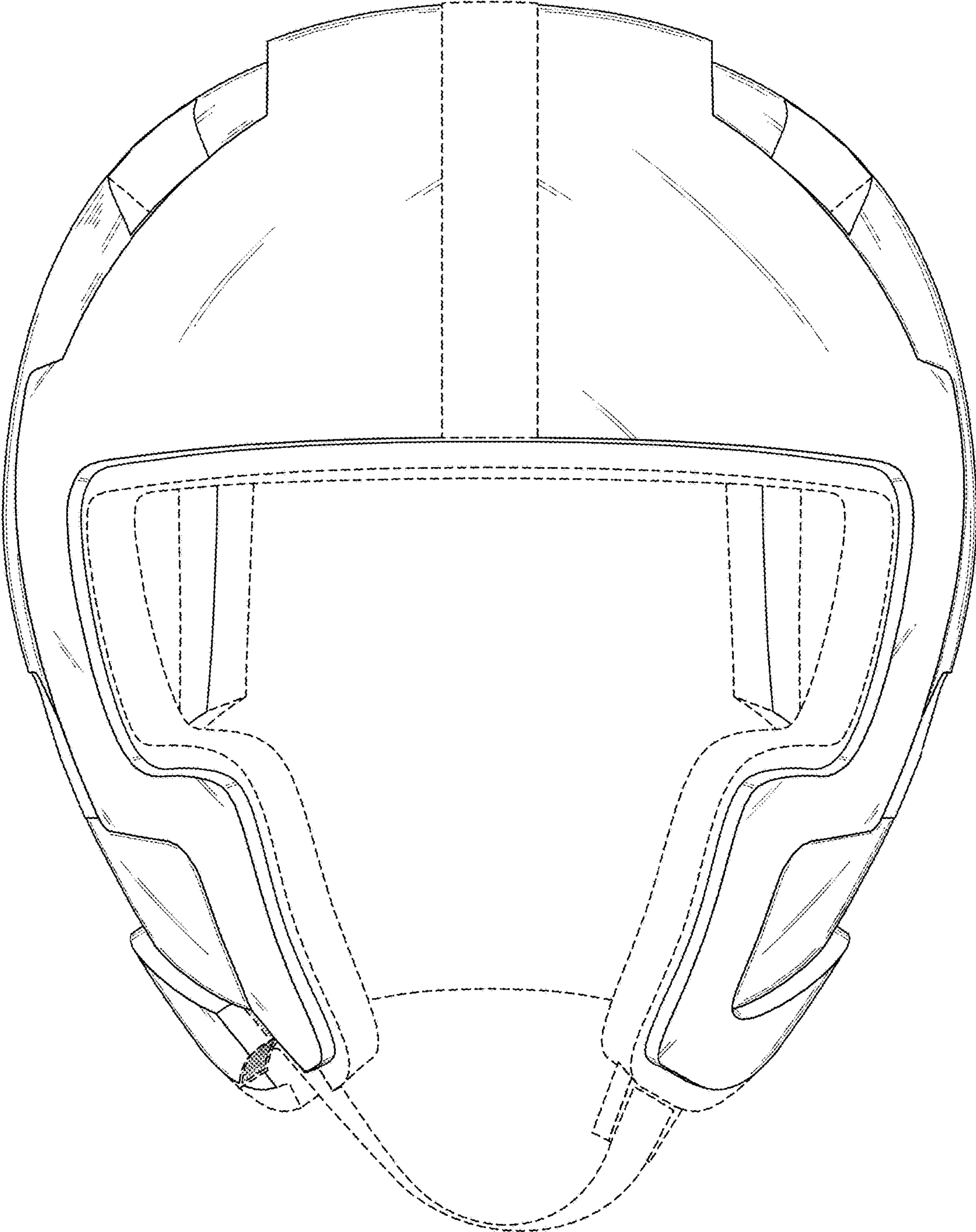


FIG. 27

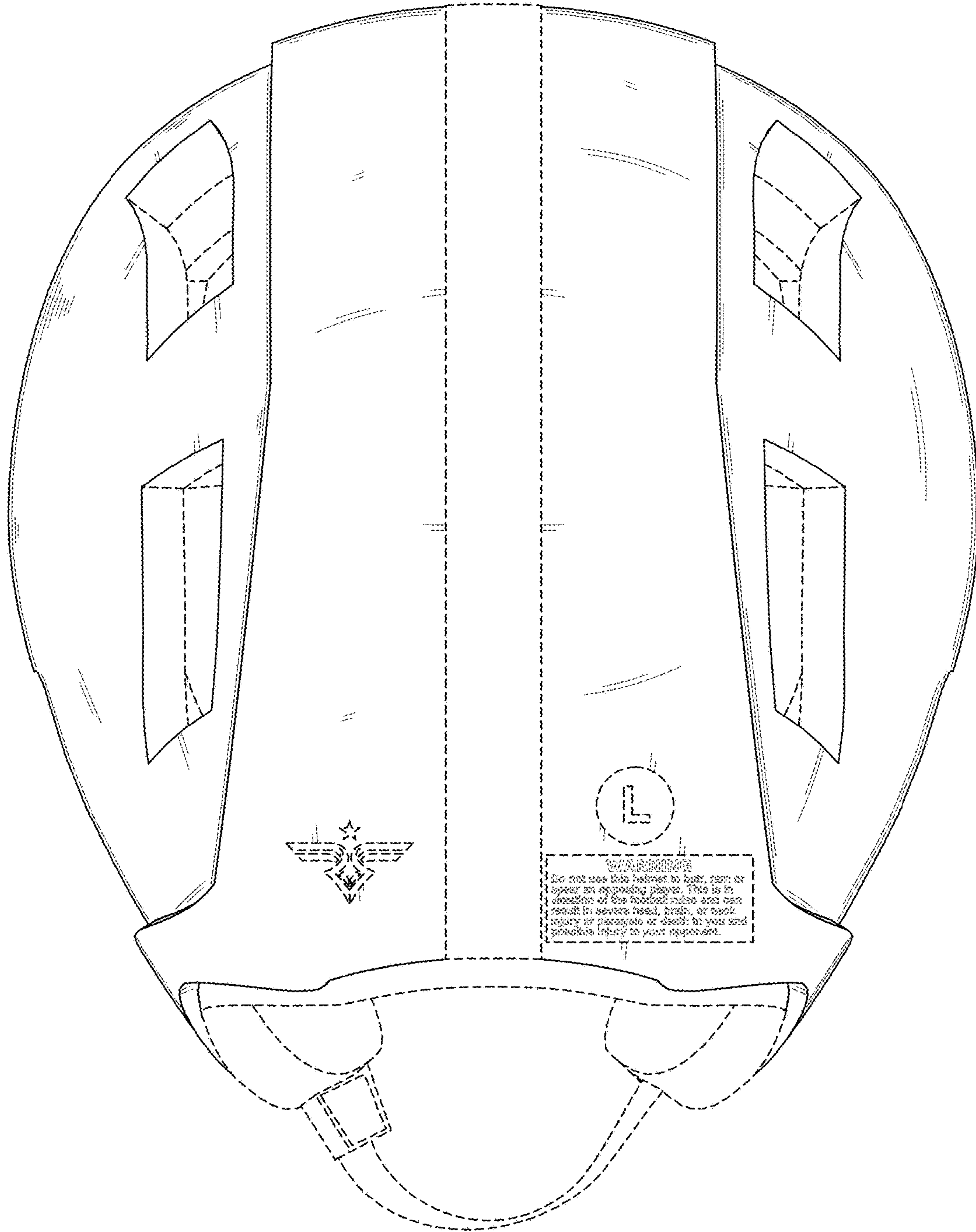


FIG. 28

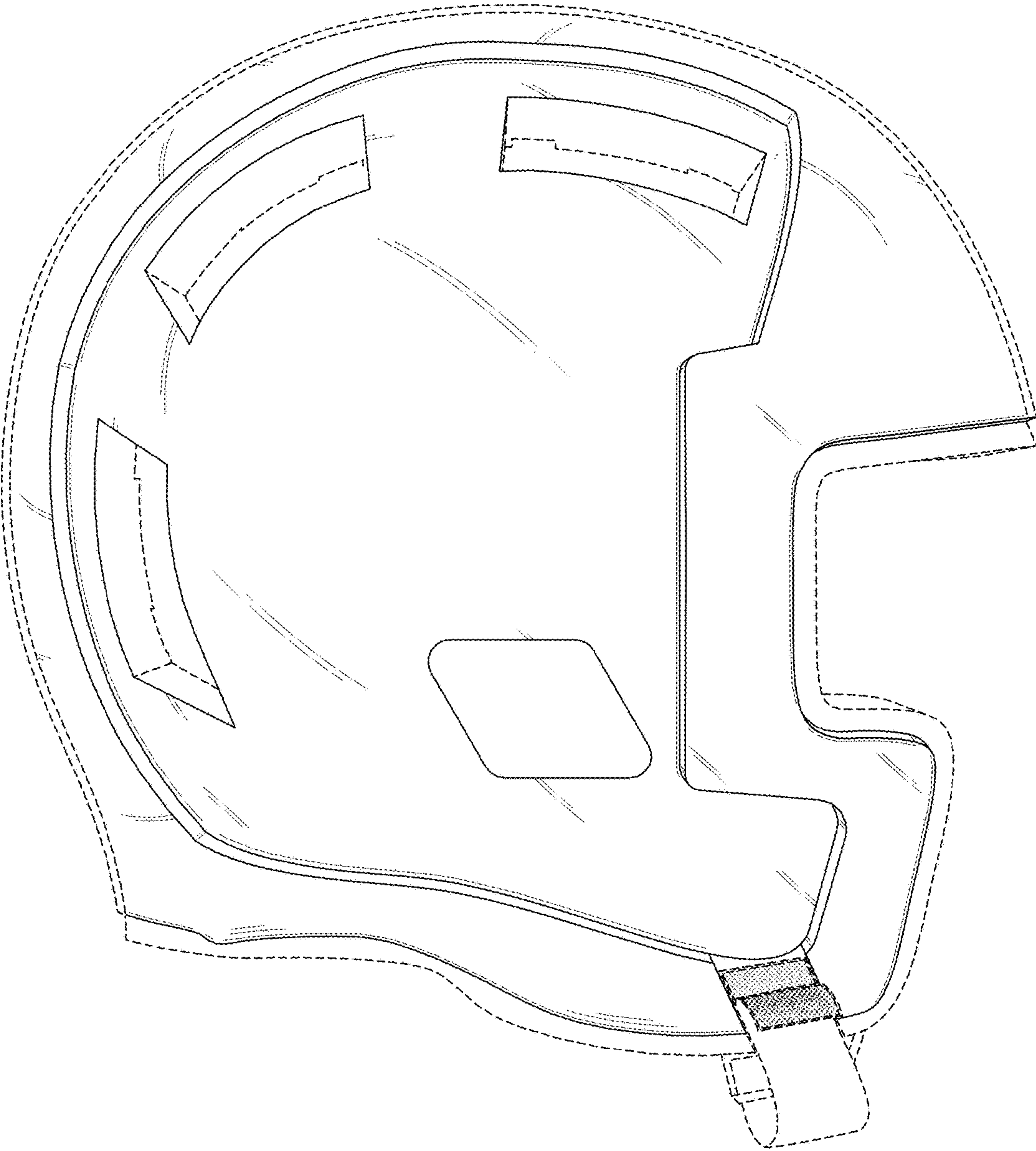
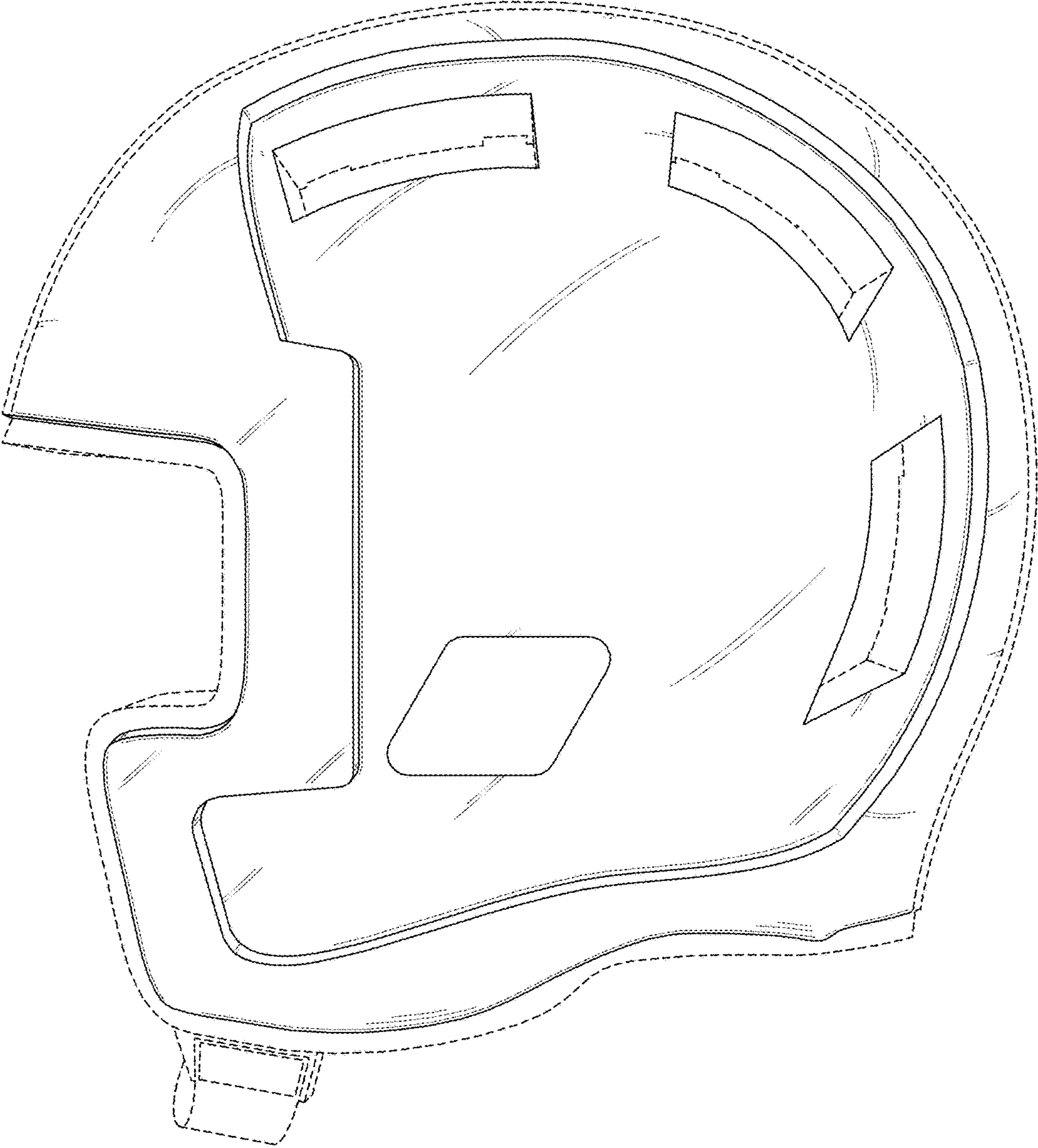


FIG. 29





**FIG. 30**

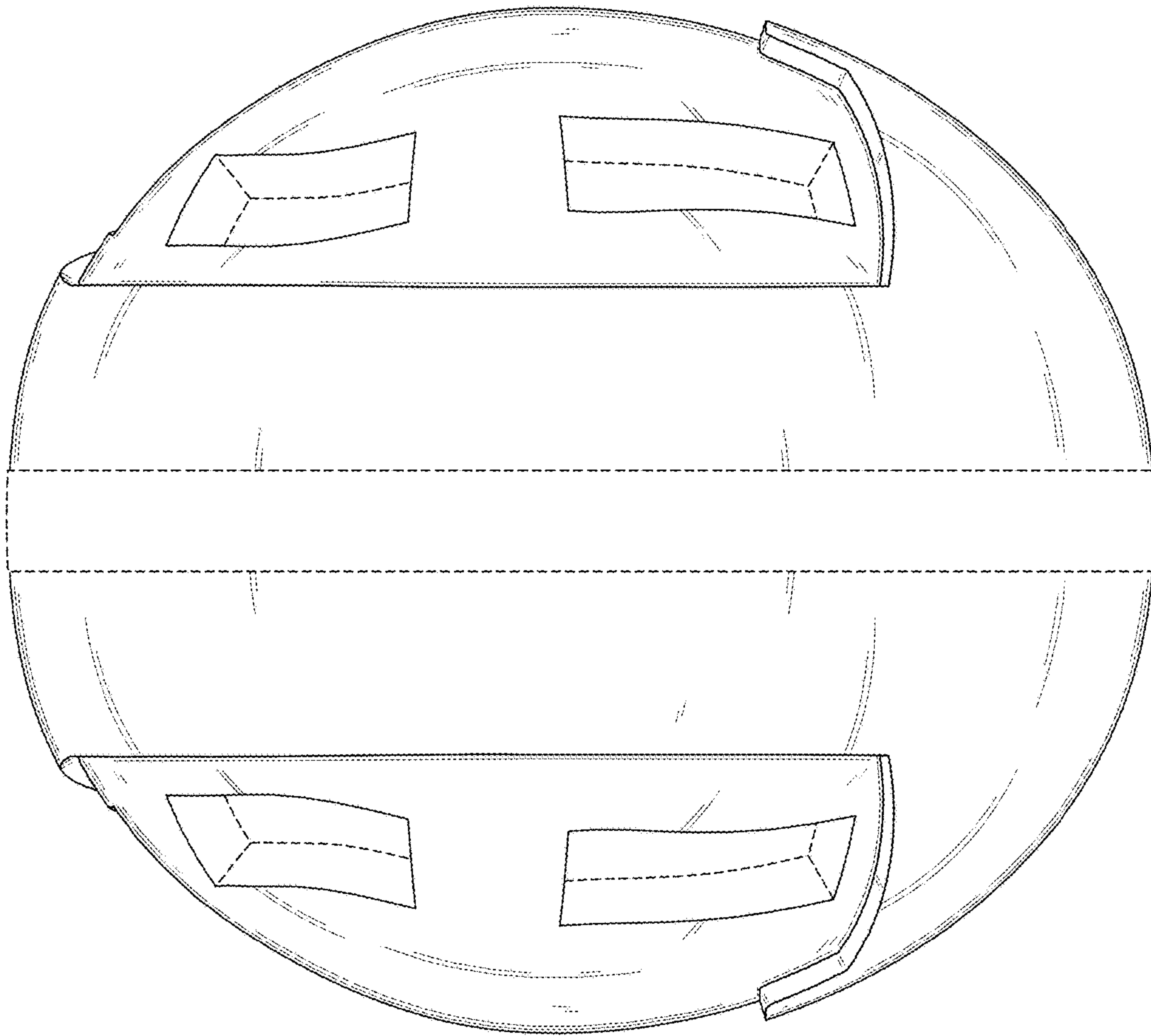


FIG. 31

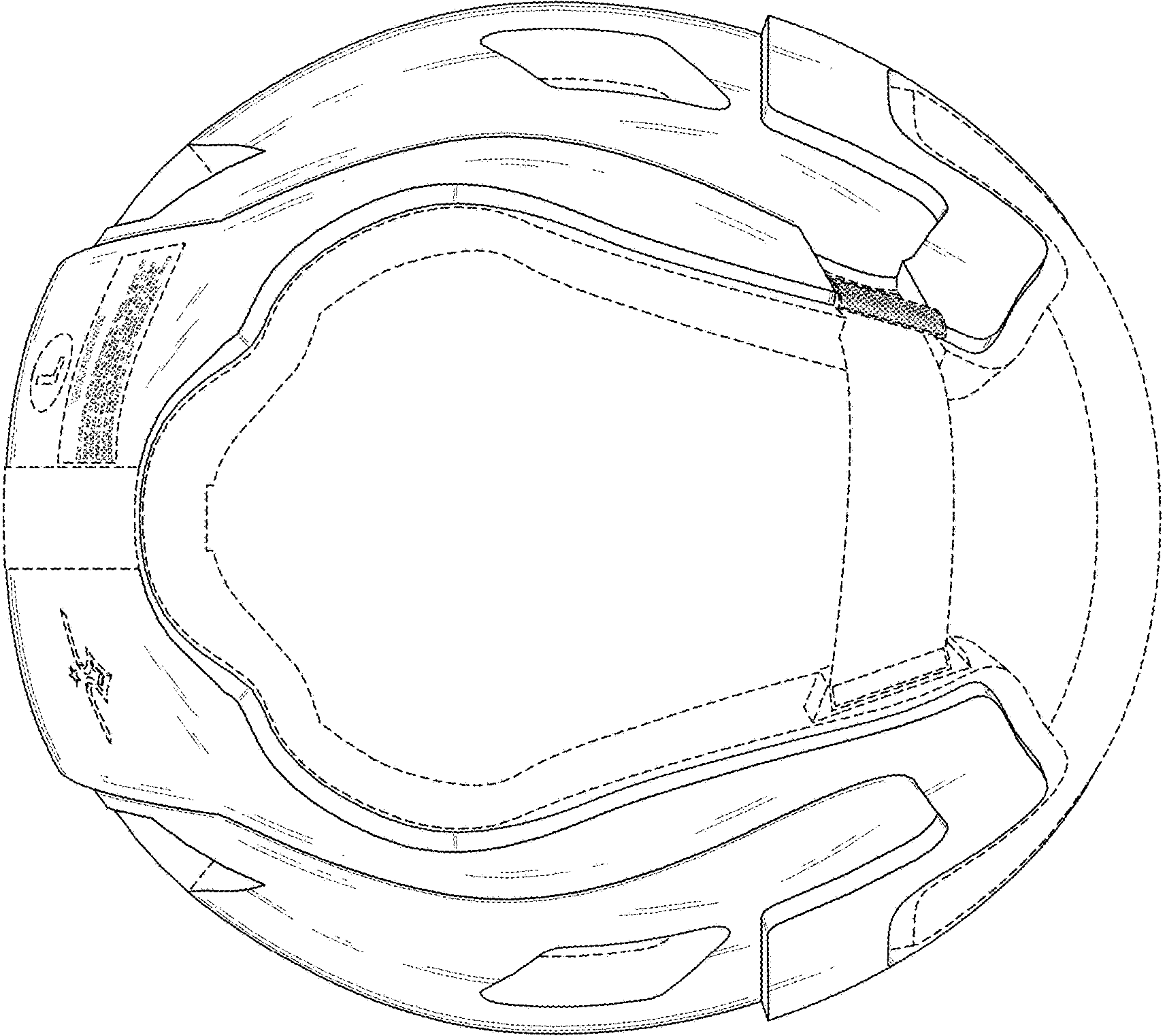


FIG. 32