



US00D774256S

(12) **United States Design Patent**  
**Katopis**

(10) **Patent No.:** **US D774,256 S**  
(45) **Date of Patent:** **\*\* Dec. 13, 2016**

- (54) **FOLDING HELMET**
- (71) Applicant: **Chris J. Katopis**, Washington, DC  
(US)
- (72) Inventor: **Chris J. Katopis**, Washington, DC  
(US)
- (\*\*) Term: **15 Years**
- (21) Appl. No.: **29/537,669**
- (22) Filed: **Aug. 27, 2015**
- (51) **LOC (10) Cl.** ..... **29-03**
- (52) **U.S. Cl.**  
USPC ..... **D29/102**
- (58) **Field of Classification Search**  
USPC ..... D29/102-107, 122  
CPC ..... A63B 71/10; A42B 3/32; A42B 3/322;  
A42B 1/06; A42B 1/004; A42B  
1/006; A42B 3/0493; A42B 3/061-3/068  
See application file for complete search history.

- 5,231,701 A \* 8/1993 Hubbard ..... A42C 1/00  
2/171
- D352,803 S 11/1994 Sasaki et al.
- 5,515,546 A 5/1996 Shifrin
- 5,628,071 A \* 5/1997 Nezer ..... A42B 3/322  
2/410
- 5,661,854 A \* 9/1997 March, II ..... A42B 3/00  
2/410
- D436,234 S \* 1/2001 Saez ..... D29/102
- 6,266,827 B1 \* 7/2001 Lampe ..... A42B 3/324  
2/414
- 6,460,194 B1 \* 10/2002 Ranzer ..... A42B 1/043  
2/200.3
- 7,958,572 B2 6/2011 Loury et al.

\* cited by examiner

*Primary Examiner* — Robert Delehanty  
(74) *Attorney, Agent, or Firm* — Chris J. Katopis

(57) **CLAIM**

The ornamental design for a folding helmet, as shown and described.

**DESCRIPTION**

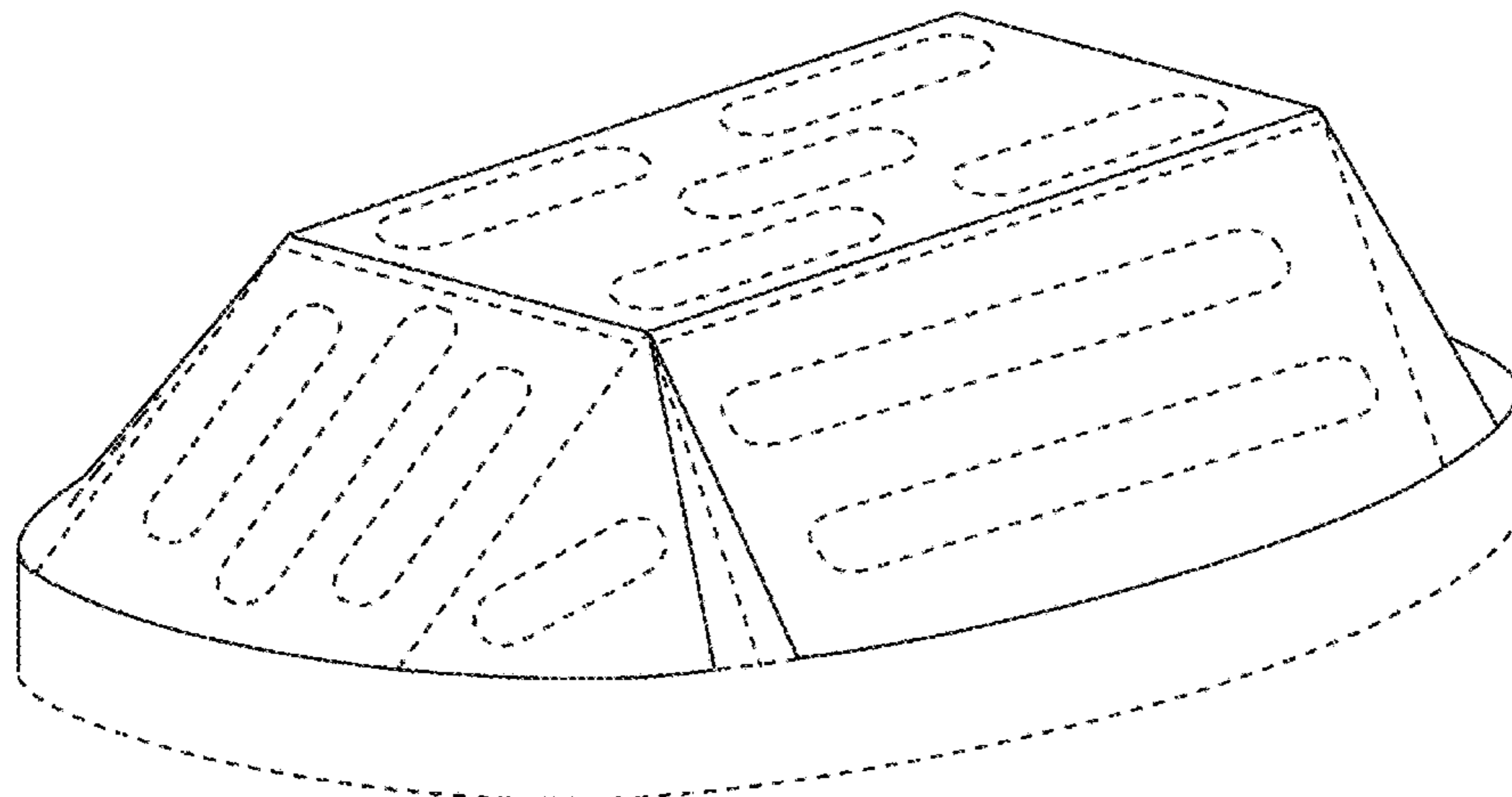
FIG. 1 is a front perspective view of a folding helmet, in an unfolded position, showing the new design;  
 FIG. 2 is a front view of thereof, in the unfolded position;  
 FIG. 3 is a back view of thereof, in the unfolded position;  
 FIG. 4 is a side view of thereof, with the opposite side view being a mirror image thereof;  
 FIG. 5 is a top view thereof;  
 FIG. 6 is a bottom view thereof; and,  
 FIG. 7 is a front perspective view thereof, in a folded position.  
 In all figures, any showing of the environment and/or drawing disclosure and/or vents by broken lines is for illustrative purposes only and forms no part of the claimed design.

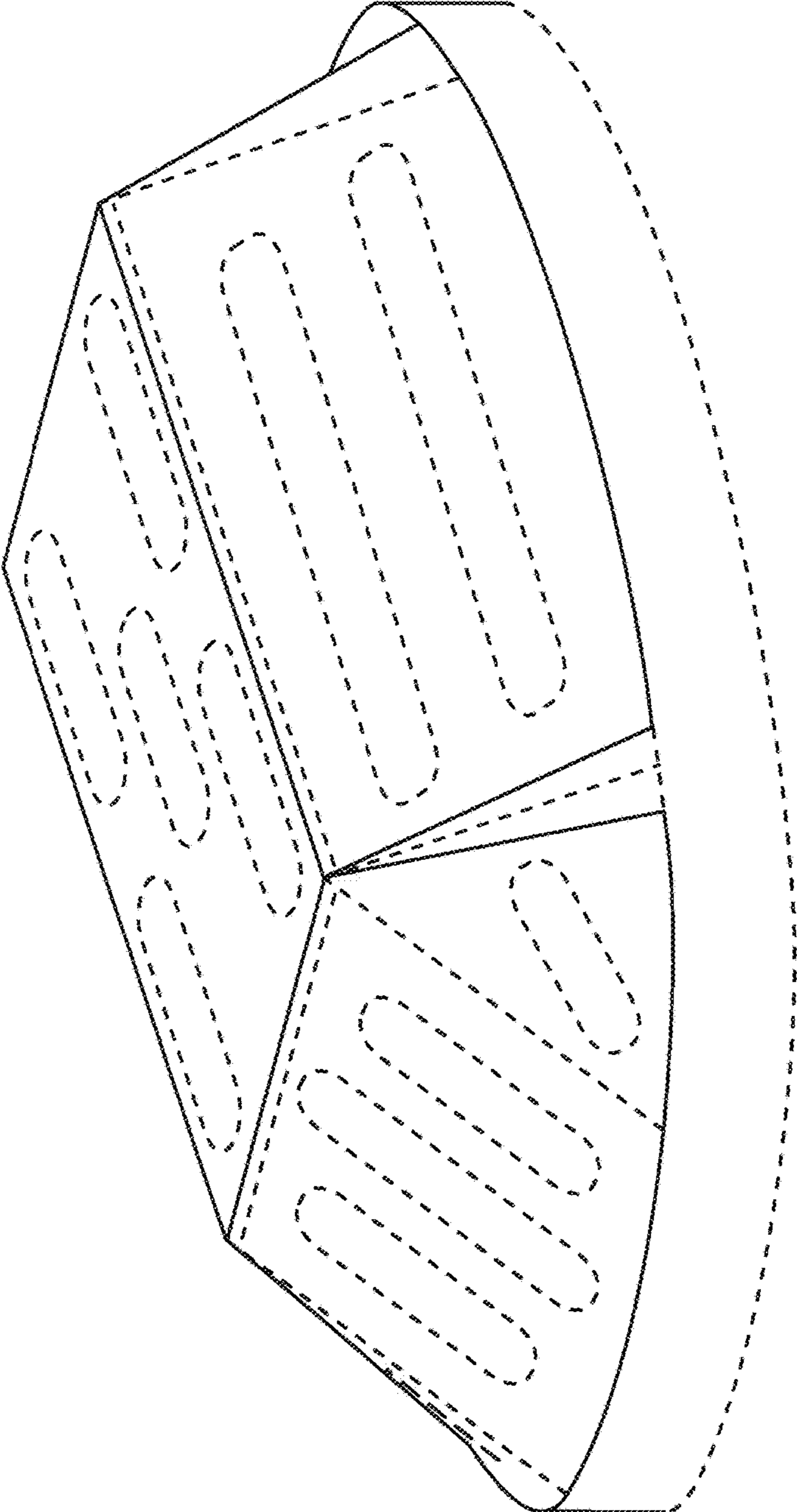
**1 Claim, 7 Drawing Sheets**

(56) **References Cited**

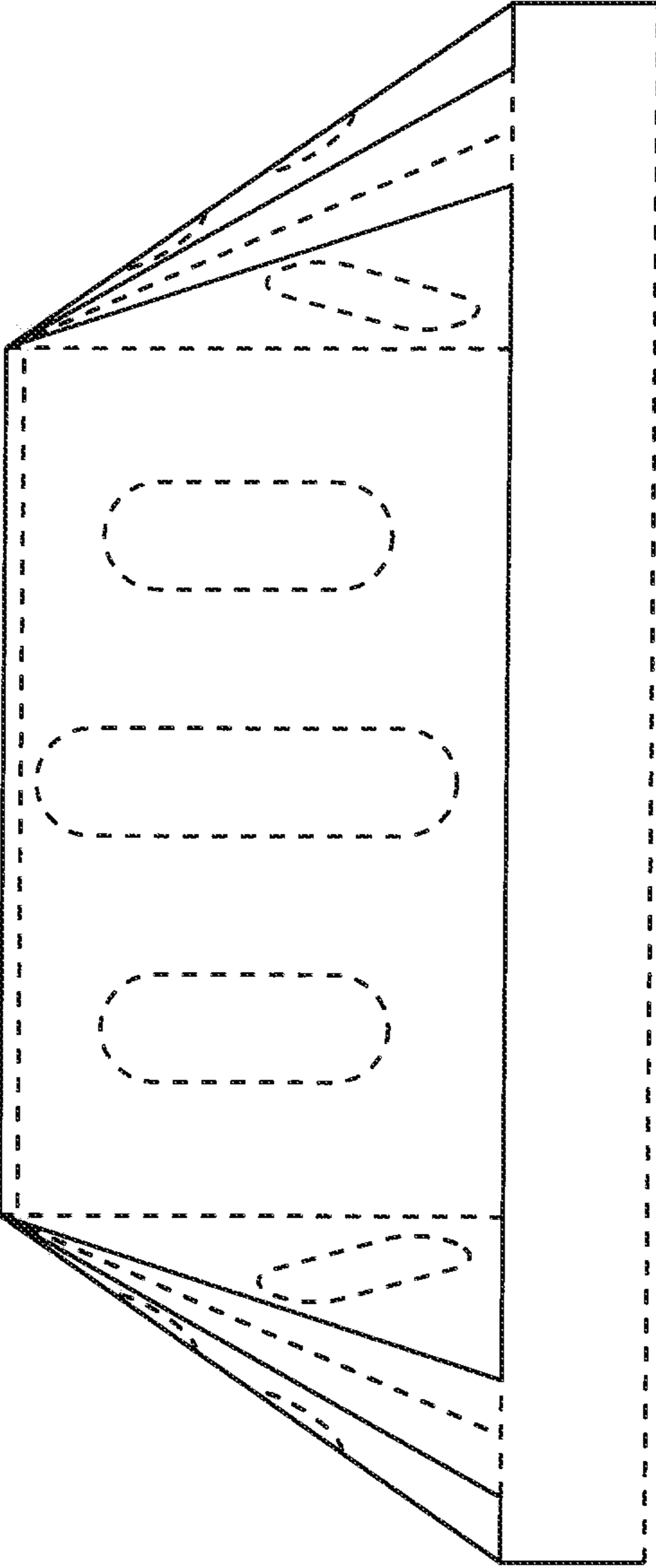
U.S. PATENT DOCUMENTS

- 3,321,774 A \* 5/1967 Tames ..... A42B 1/043  
2/181
- 3,384,904 A \* 5/1968 Hofmann ..... A42B 1/06  
2/195.7
- 3,987,495 A \* 10/1976 Holley ..... A42B 3/322  
2/410
- 3,991,422 A \* 11/1976 Saotome ..... A42B 3/322  
2/410
- 4,091,467 A \* 5/1978 Zuccaro ..... A42C 1/00  
2/171
- 4,291,417 A \* 9/1981 Pagano ..... A42B 1/201  
2/202
- 4,587,674 A \* 5/1986 Berlin ..... A42B 1/043  
2/171.01

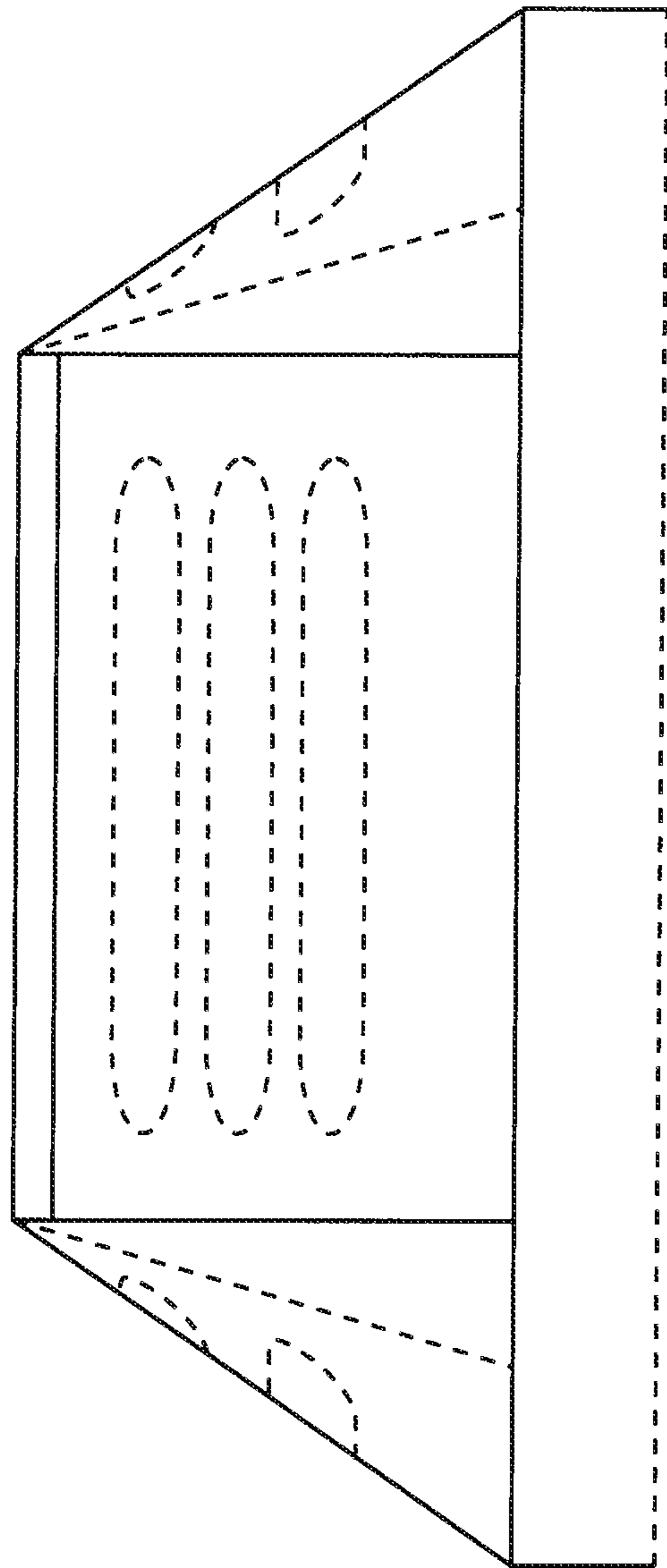




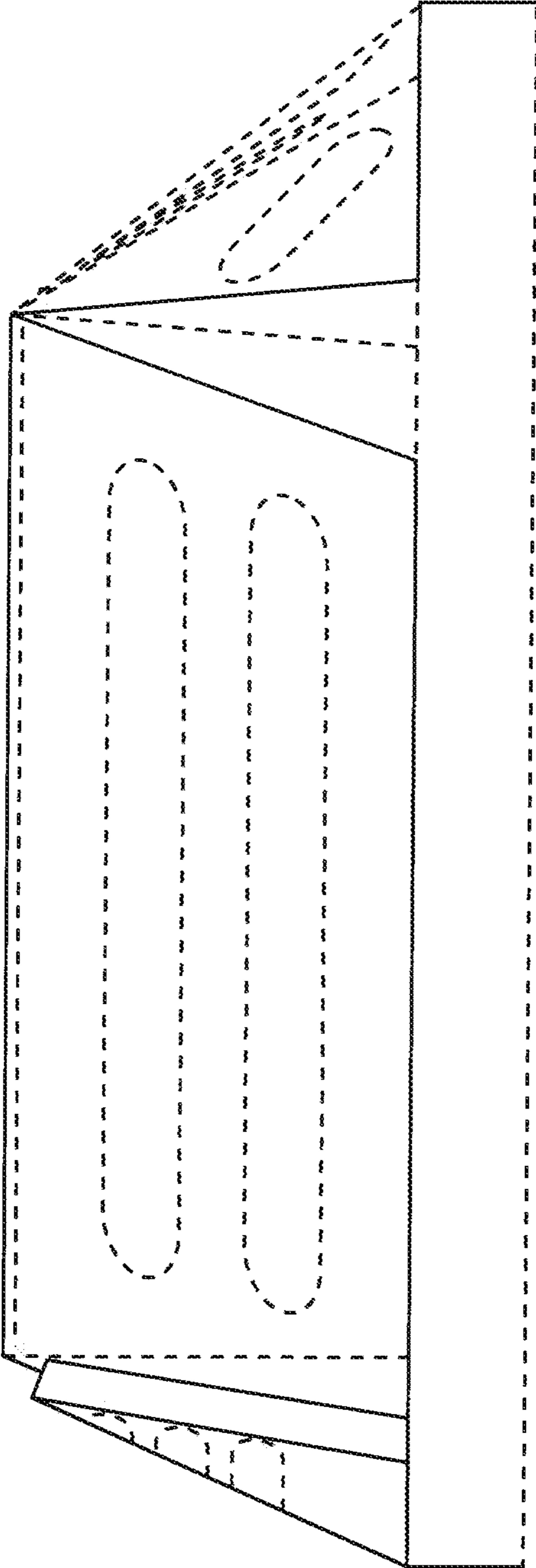
**FIG. 1**



**FIG. 2**



**FIG. 3**



**FIG. 4**

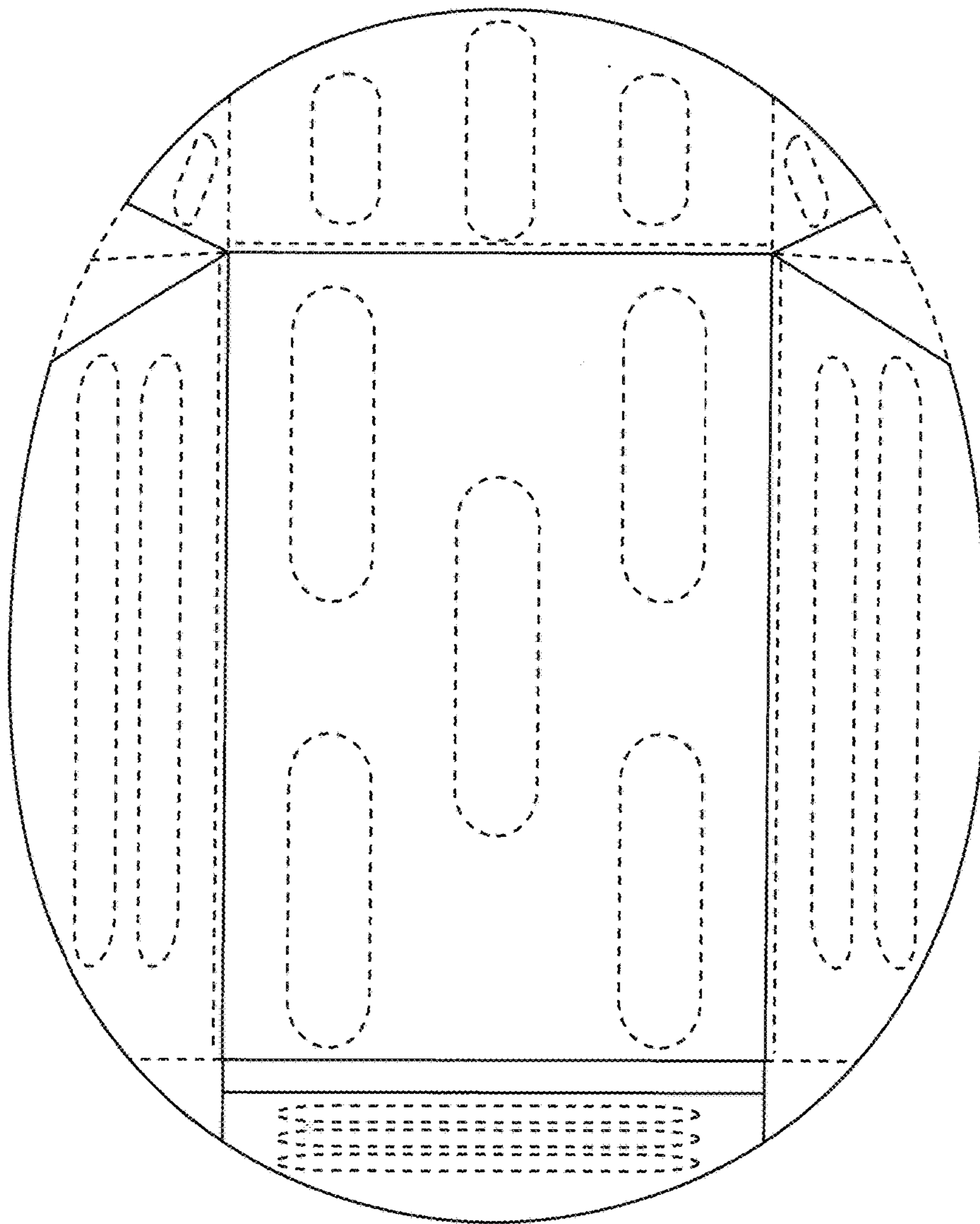
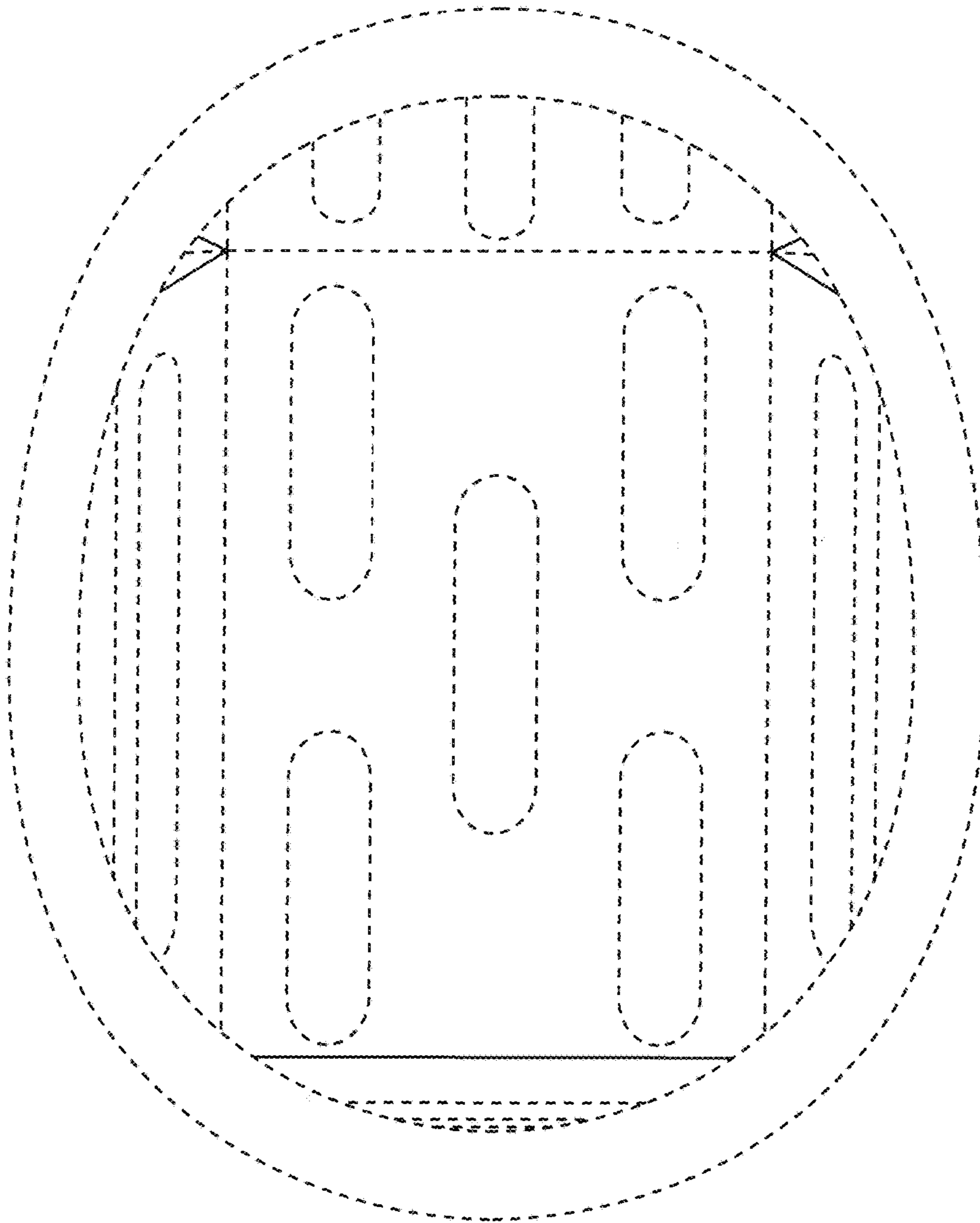
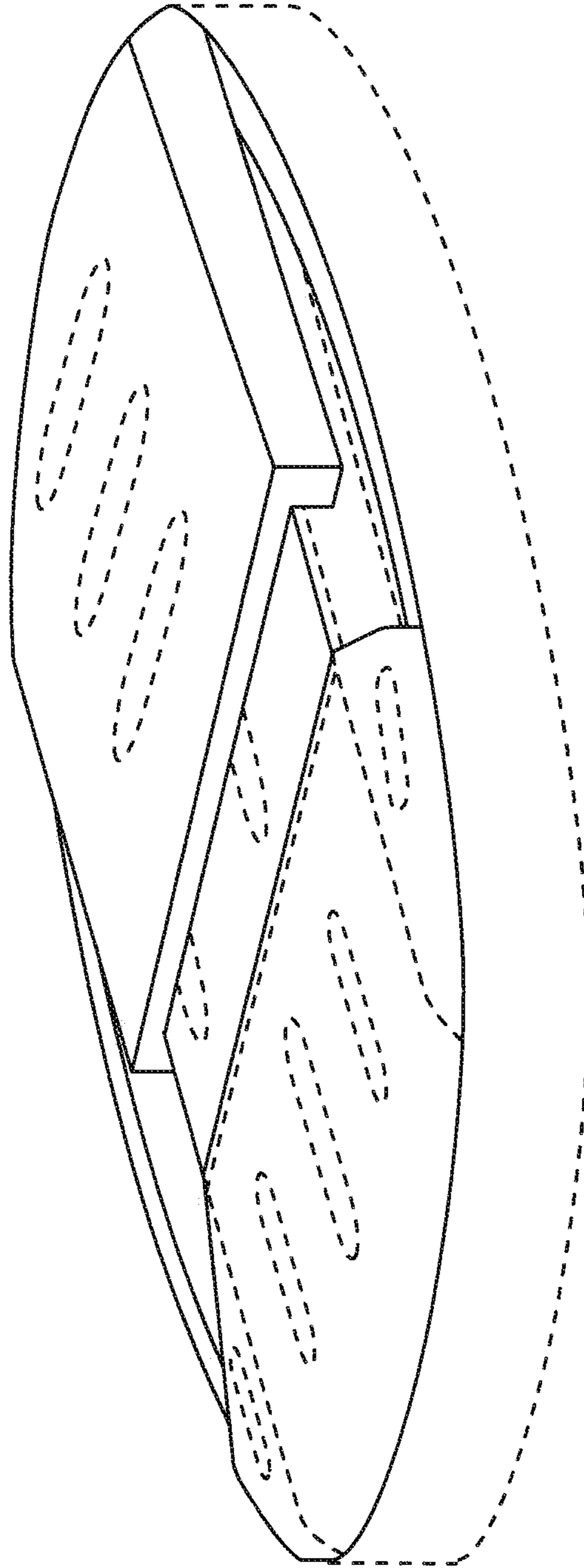


FIG. 5





**FIG. 6**



**FIG. 7**