



US00D774118S

(12) **United States Design Patent**
Demmeler

(10) **Patent No.:** **US D774,118 S**

(45) **Date of Patent:** **** Dec. 13, 2016**

(54) **WELDING TABLE**

(71) Applicant: **Johannes Demmeler**, Memmingen
(DE)

(72) Inventor: **Johannes Demmeler**, Memmingen
(DE)

(**) Term: **14 Years**

(21) Appl. No.: **29/483,583**

(22) Filed: **Feb. 28, 2014**

(30) **Foreign Application Priority Data**

Aug. 29, 2013 (DE) 40 2013 003 938

(51) **LOC (10) Cl.** **15-09**

(52) **U.S. Cl.**
USPC **D15/144**

(58) **Field of Classification Search**
USPC D15/144, 144.1, 144.2
See application file for complete search history.

(56) **References Cited**

U.S. PATENT DOCUMENTS

- 1,402,881 A * 1/1922 Murchie B23K 5/22
164/DIG. 12
- 1,603,307 A * 10/1926 Anderson B23K 37/0461
248/185.1
- 2,310,904 A * 2/1943 Bales B23K 5/22
108/159
- 2,724,038 A * 11/1955 Bentzen B23K 37/0461
219/158
- 3,188,078 A * 6/1965 Peterson B21D 43/003
269/305

- 4,625,951 A * 12/1986 Yang B25H 1/04
269/100
- 4,867,427 A * 9/1989 Cunningham B25B 5/003
269/166
- 5,318,284 A * 6/1994 Demmeler B23K 37/0461
269/203

(Continued)

Primary Examiner — Patricia Palasik
(74) *Attorney, Agent, or Firm* — Oliff PLC

(57) **CLAIM**

The ornamental design for a welding table, as shown and described.

DESCRIPTION

FIG. 1 is a perspective view according to a first embodiment of a welding table;
 FIG. 2 is a front view of thereof;
 FIG. 3 is a top view thereof;
 FIG. 4 is a side view thereof;
 FIG. 5 is another perspective view thereof;
 FIG. 6 is an enlarged view of a corner of a top of the welding table shown in the box labeled “6” in FIG. 1;
 FIG. 7 is a perspective view according to a second embodiment of the welding table;
 FIG. 8 is a side view thereof;
 FIG. 9 is a front view thereof;
 FIG. 10 is a second perspective view thereof;
 FIG. 11 is a perspective view according to a third embodiment of the welding table;
 FIG. 12 is another perspective view thereof;
 FIG. 13 is an enlarged view of a bore hole in a top of the welding table shown in the box labeled “13” in FIG. 1; and,
 FIG. 14 is an enlarged view of a corner of a top of the welding table shown in the box labeled “14” in FIG. 11.
 In the claimed design, the legs of the welding table are colored yellow. The dashed line boxes indicate portions of the drawings that are shown enlarged in other views, and do not form any part of the claimed design.

1 Claim, 14 Drawing Sheets

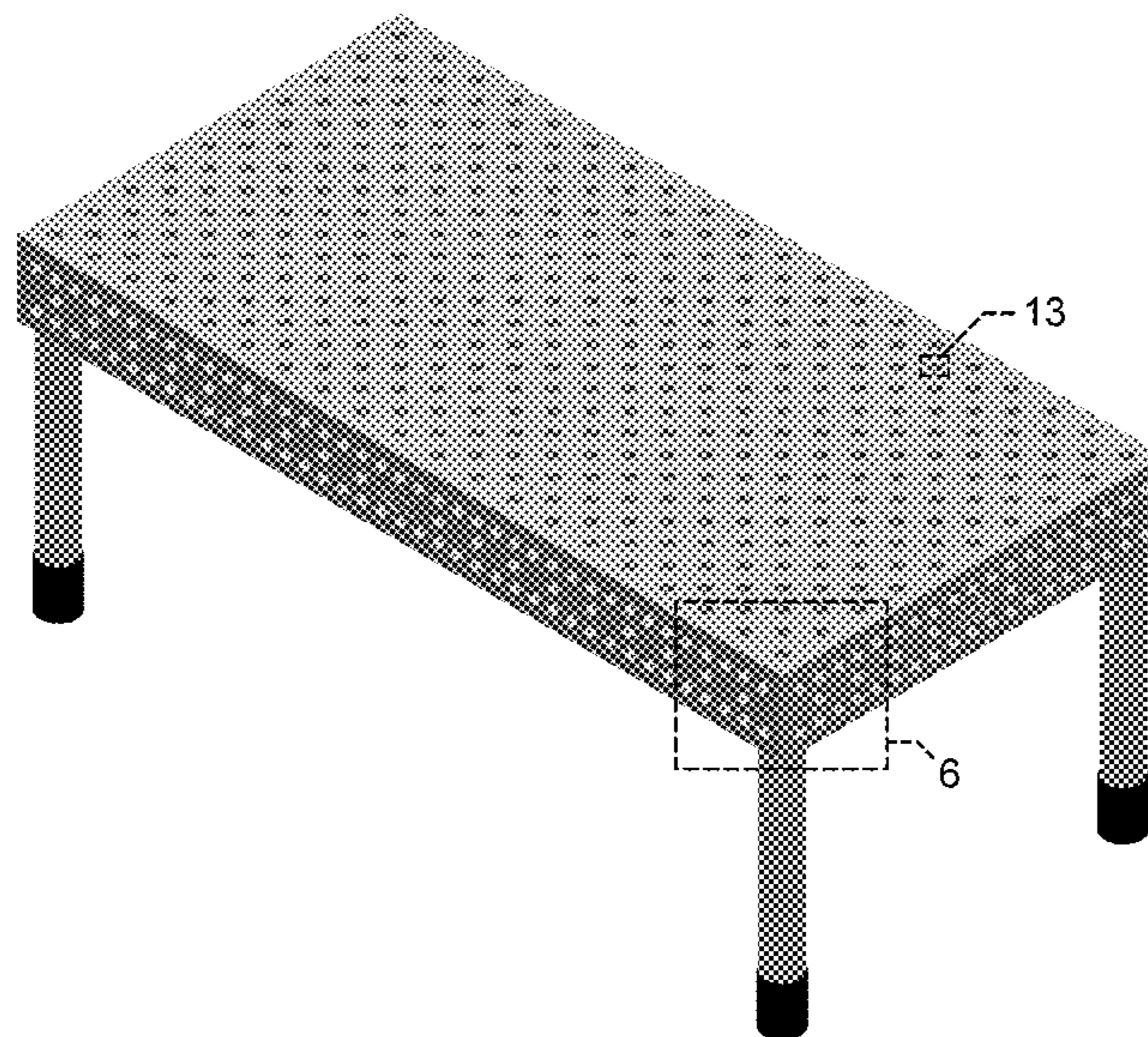

(56)

References Cited

U.S. PATENT DOCUMENTS

5,901,763	A *	5/1999	You	B23D 47/025 144/286.1
6,019,359	A *	2/2000	Fly	B23K 37/0461 269/289 R
6,024,350	A *	2/2000	Price	B25B 5/068 269/246
6,148,881	A *	11/2000	Valenzuela	B25H 1/005 108/11
8,065,967	B2 *	11/2011	Wong	B23K 37/0461 108/155
8,151,458	B2 *	4/2012	Hlavaty	B23Q 3/063 269/240
8,777,204	B2 *	7/2014	Ruland	B25H 1/08 269/3
8,784,939	B2 *	7/2014	Romero	A43D 8/22 101/134.5
8,794,612	B2 *	8/2014	Chuang	B25B 5/101 269/128
8,807,549	B2 *	8/2014	Henze	B25B 5/006 269/149
8,991,024	B2 *	3/2015	Barillaro	B25B 5/101 269/140
9,015,917	B2 *	4/2015	Norton	B25B 5/003 29/270
9,022,333	B2 *	5/2015	Chen	F16B 7/22 248/228.4
9,022,374	B1 *	5/2015	Baryam	B25B 5/105 269/143
9,027,913	B2 *	5/2015	Li	B25B 5/04 269/6

* cited by examiner

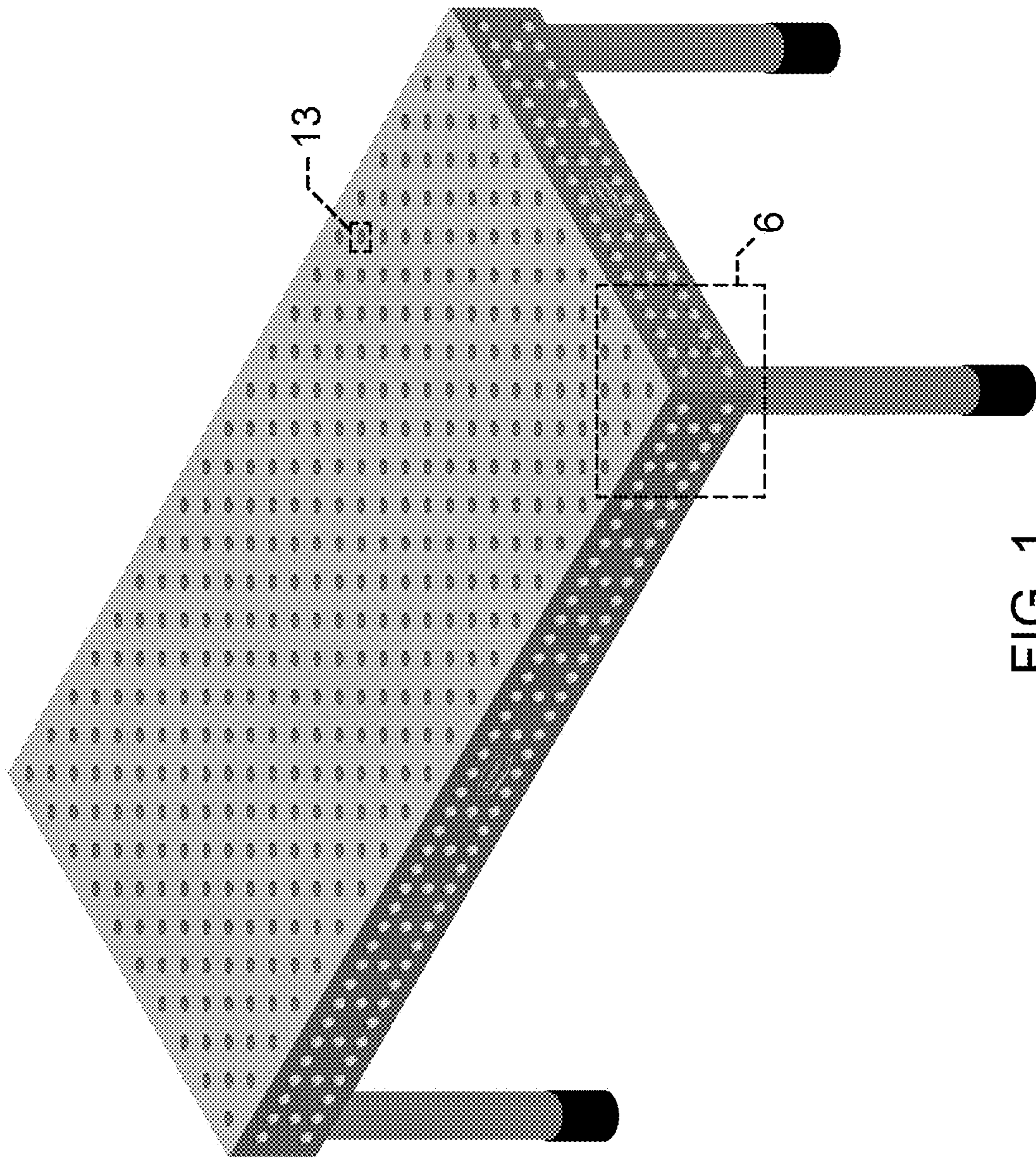

FIG. 1

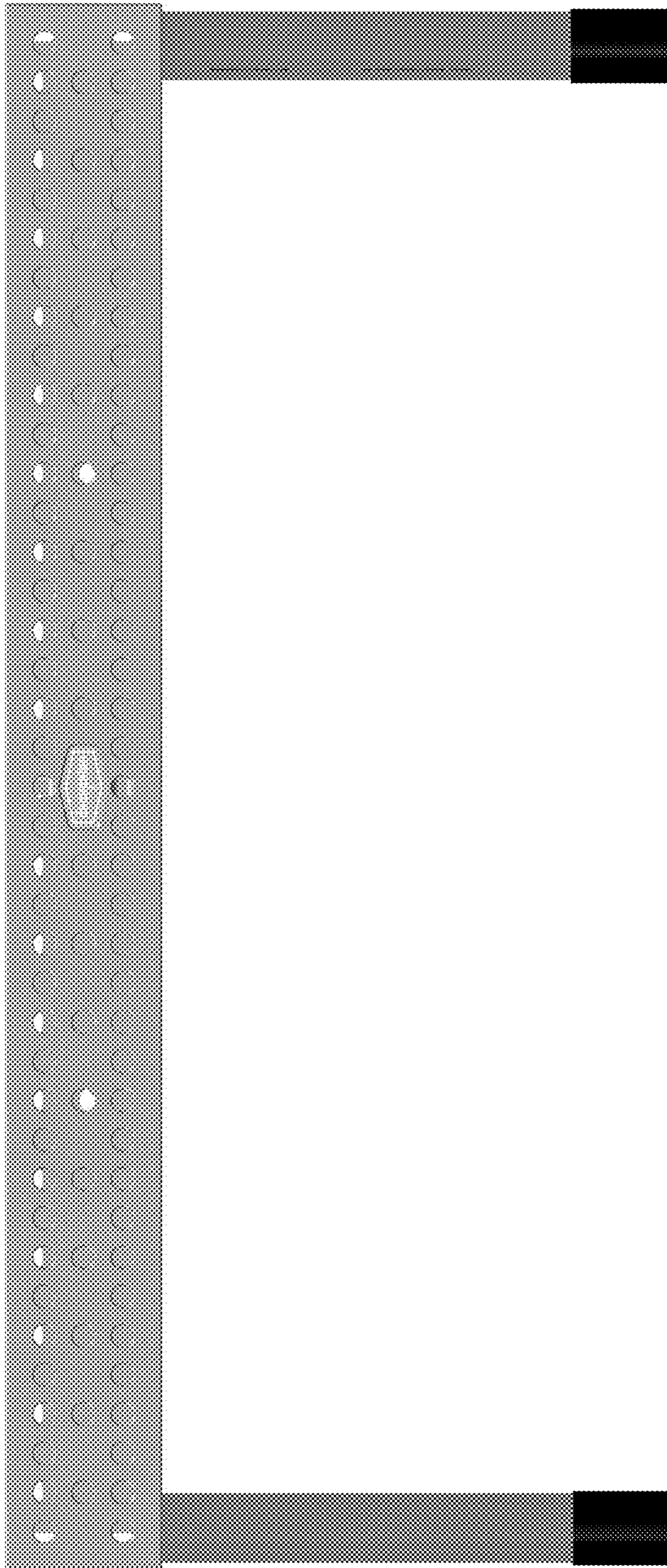

FIG. 2

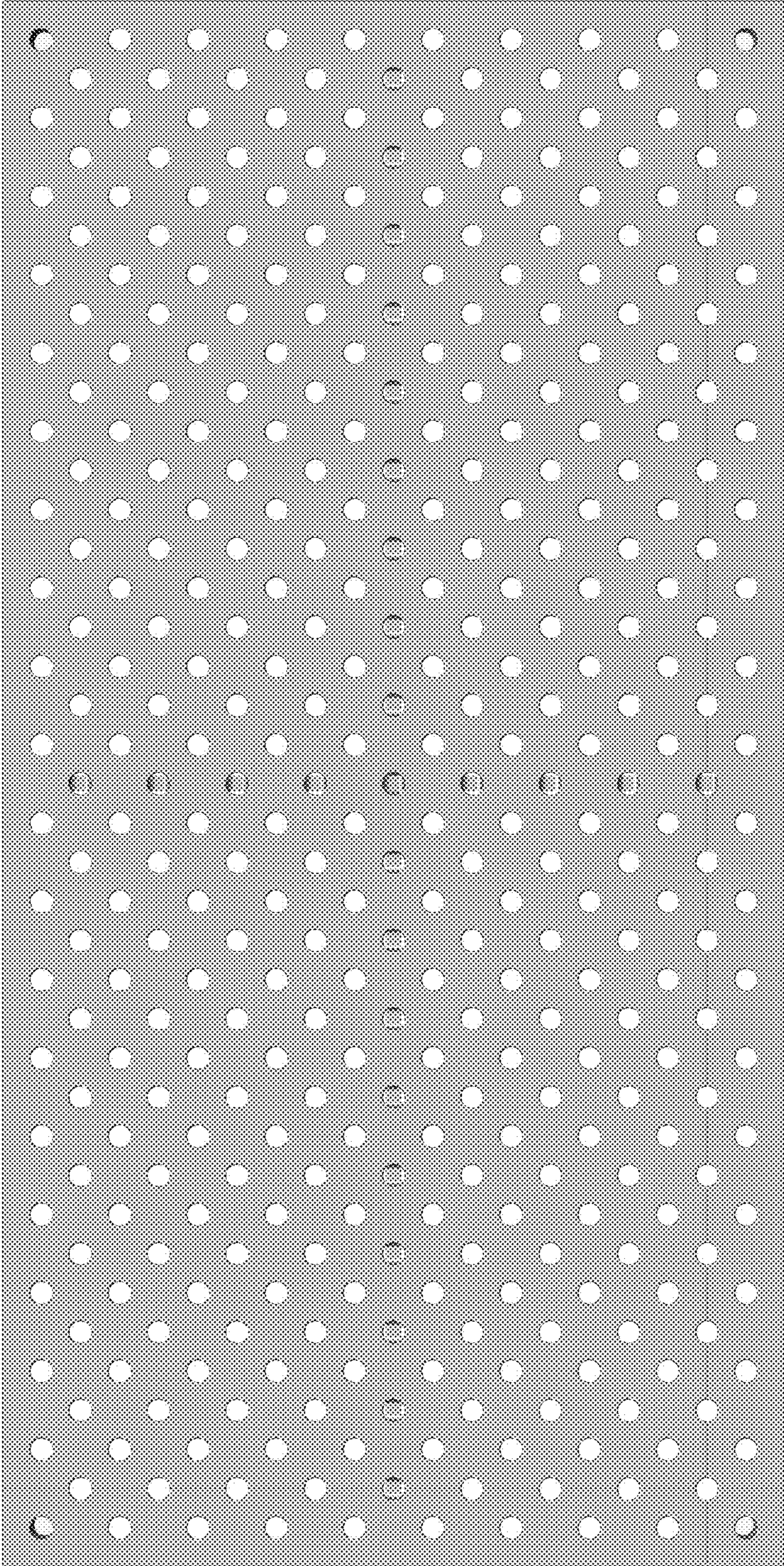

FIG. 3

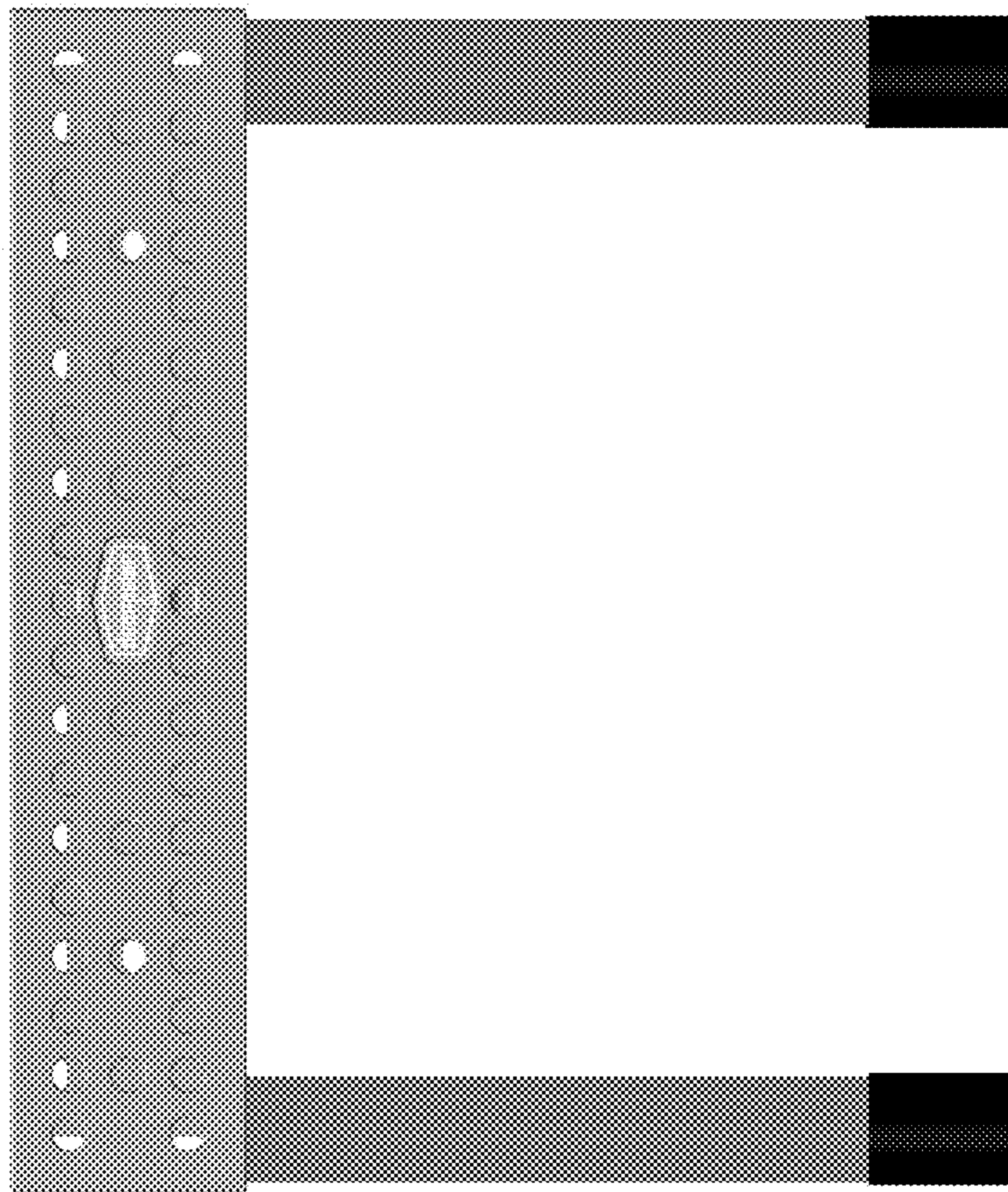

FIG. 4

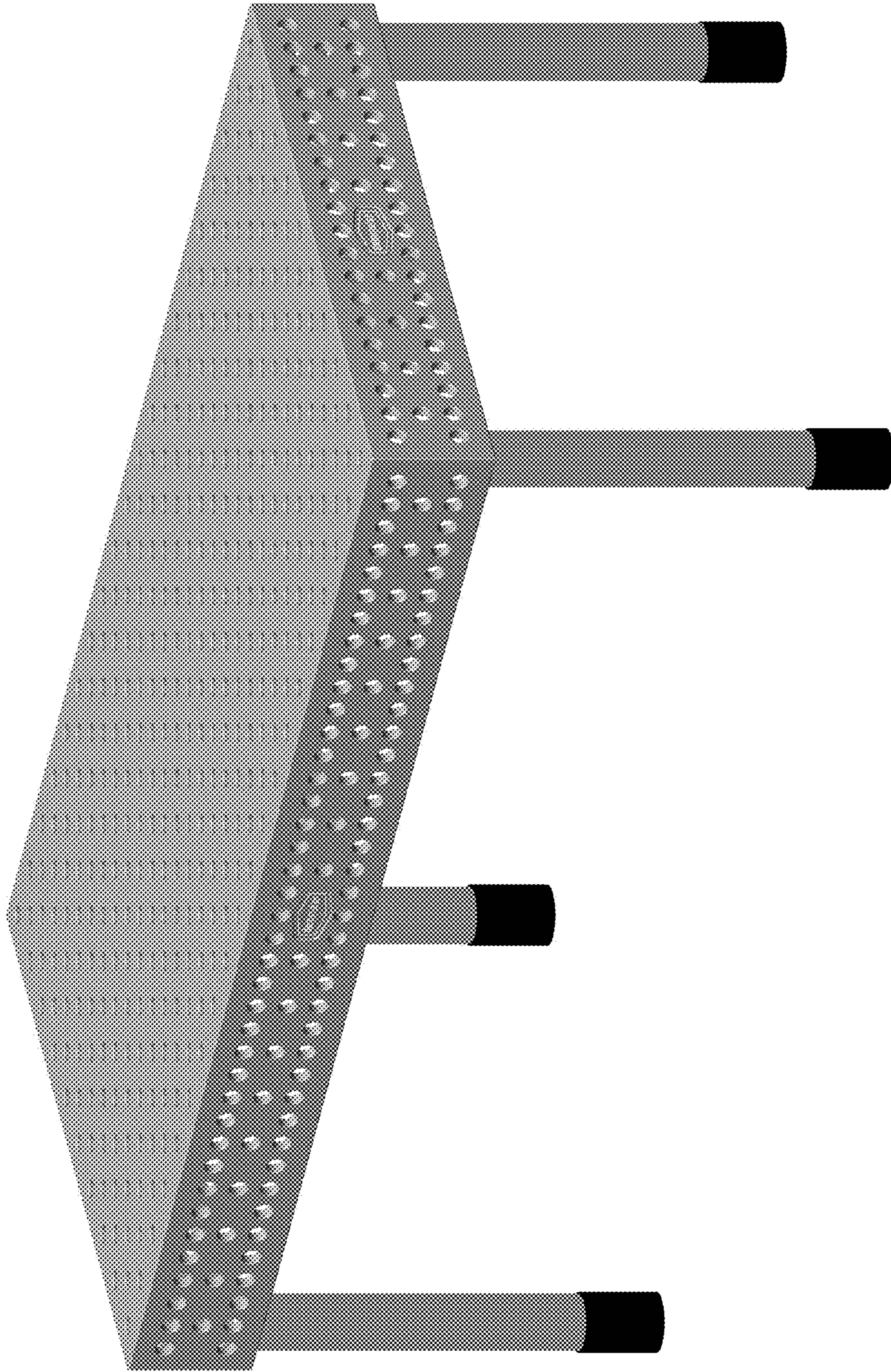

FIG. 5

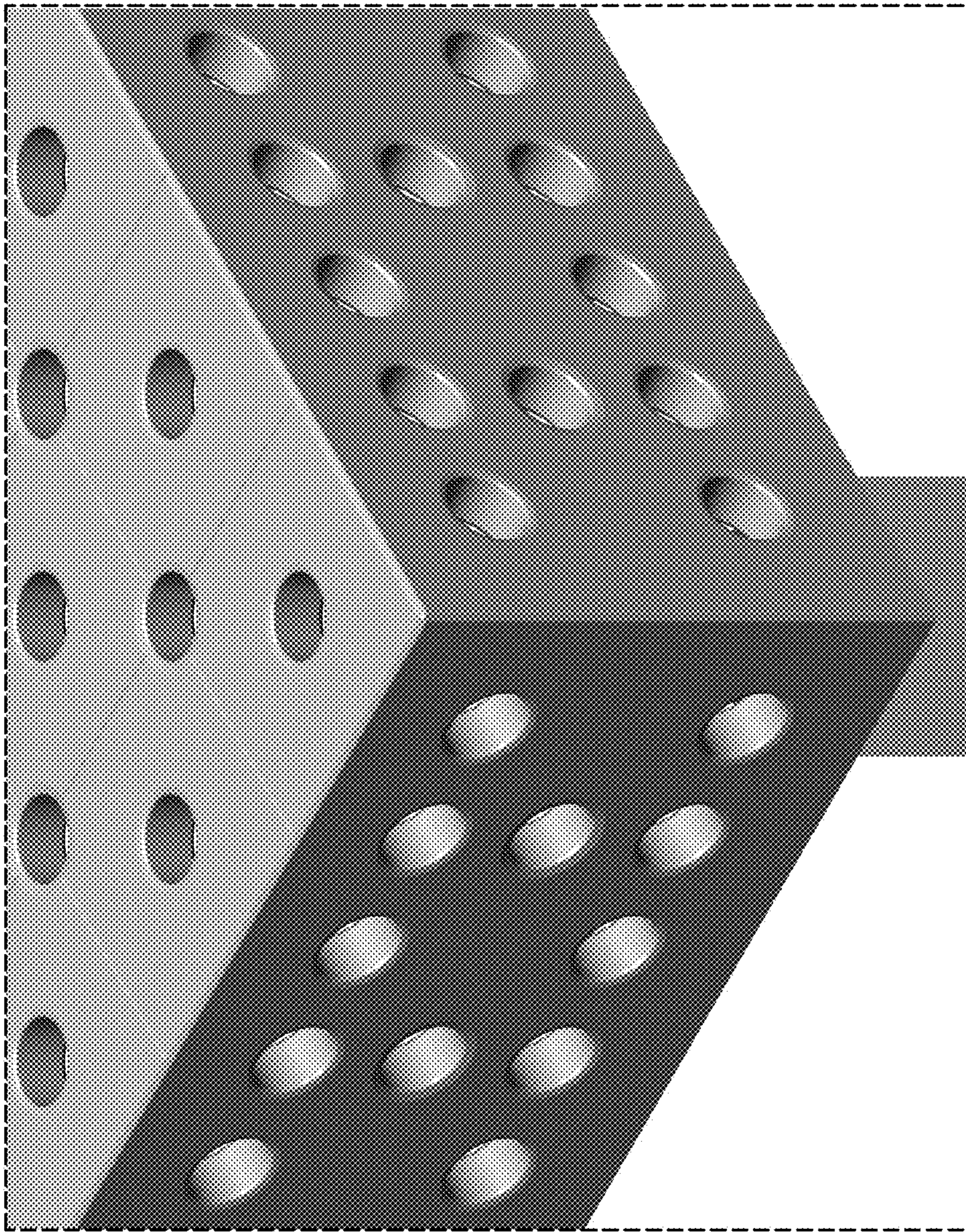

FIG. 6

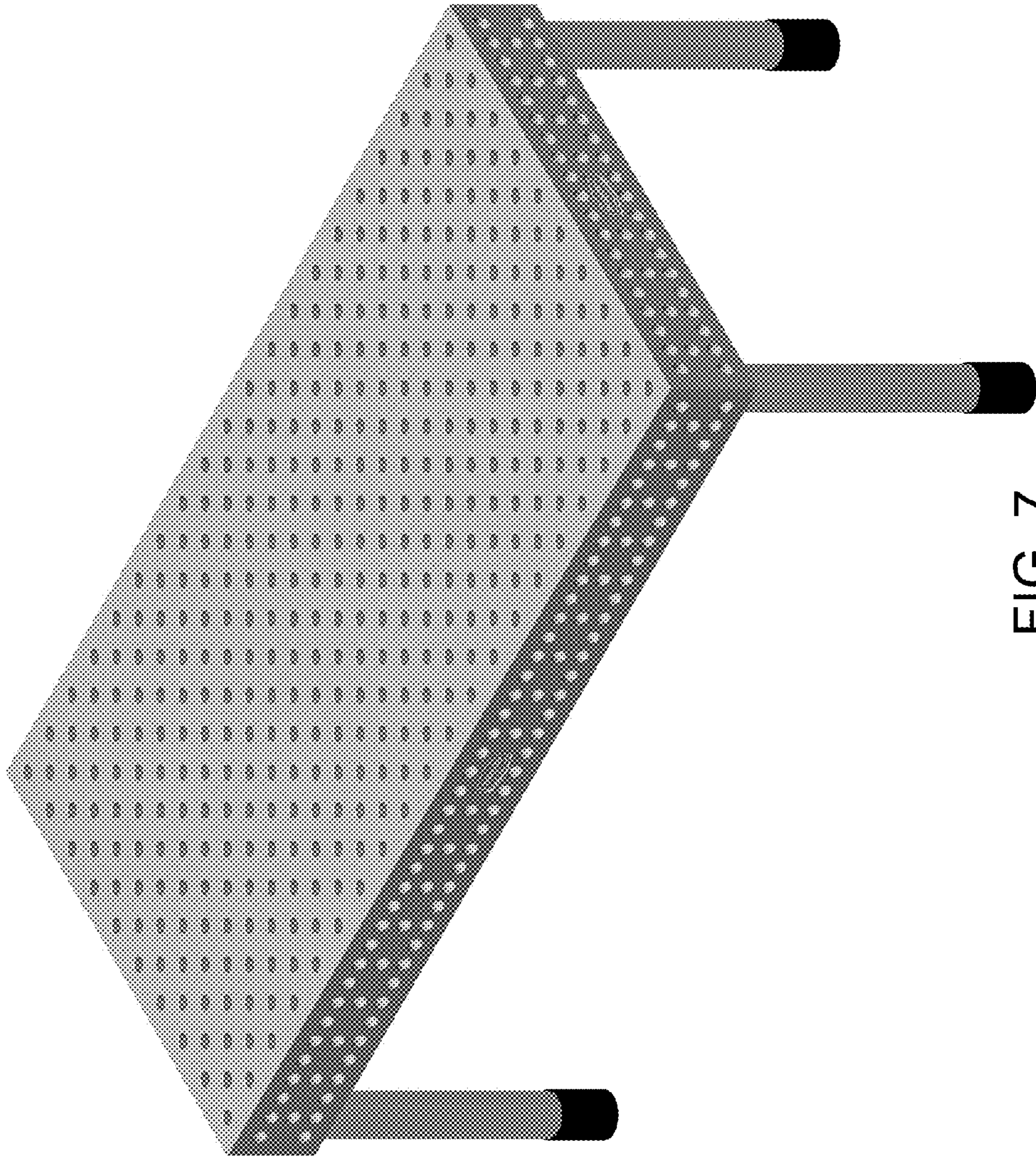

FIG. 7

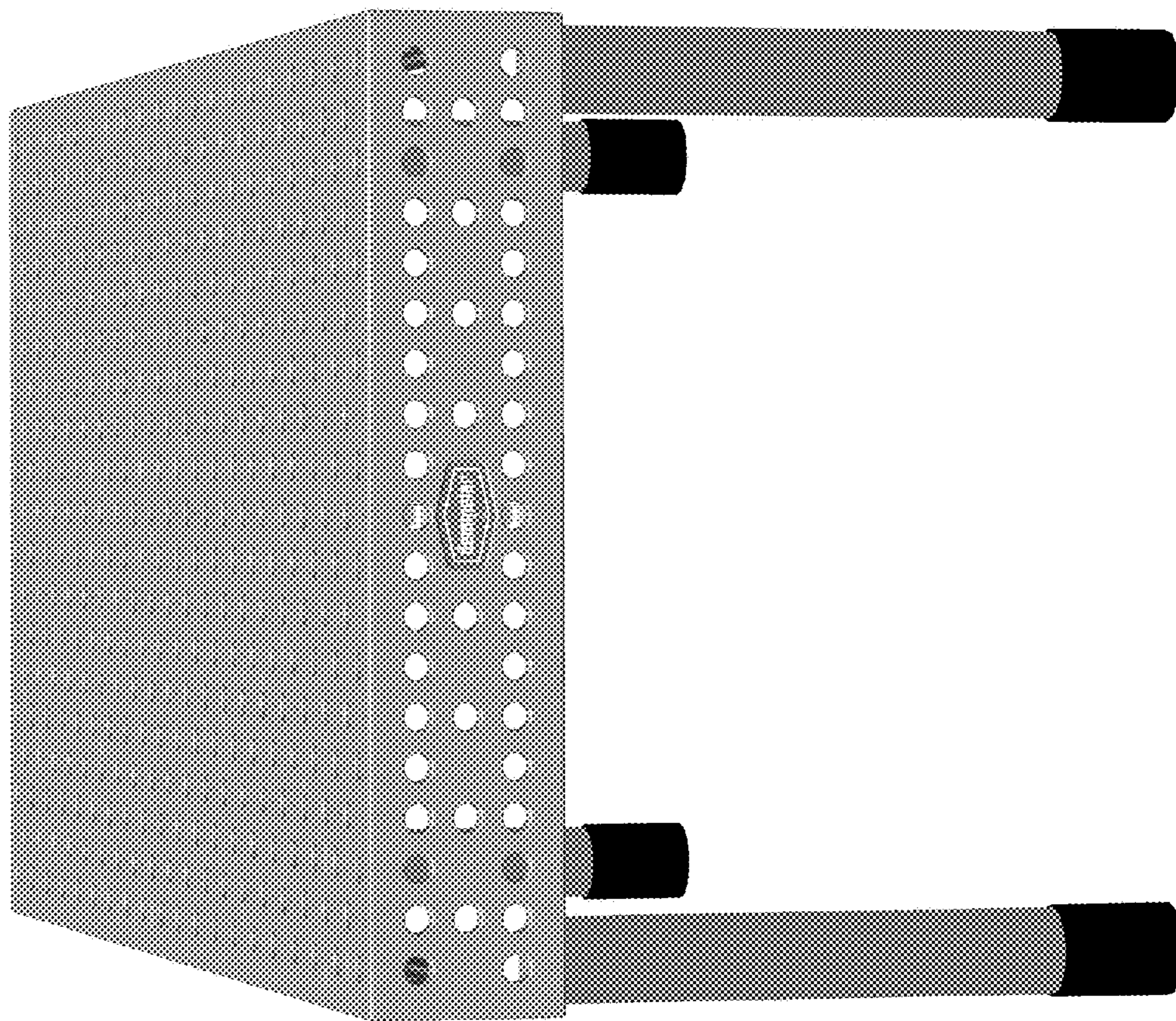

FIG. 8

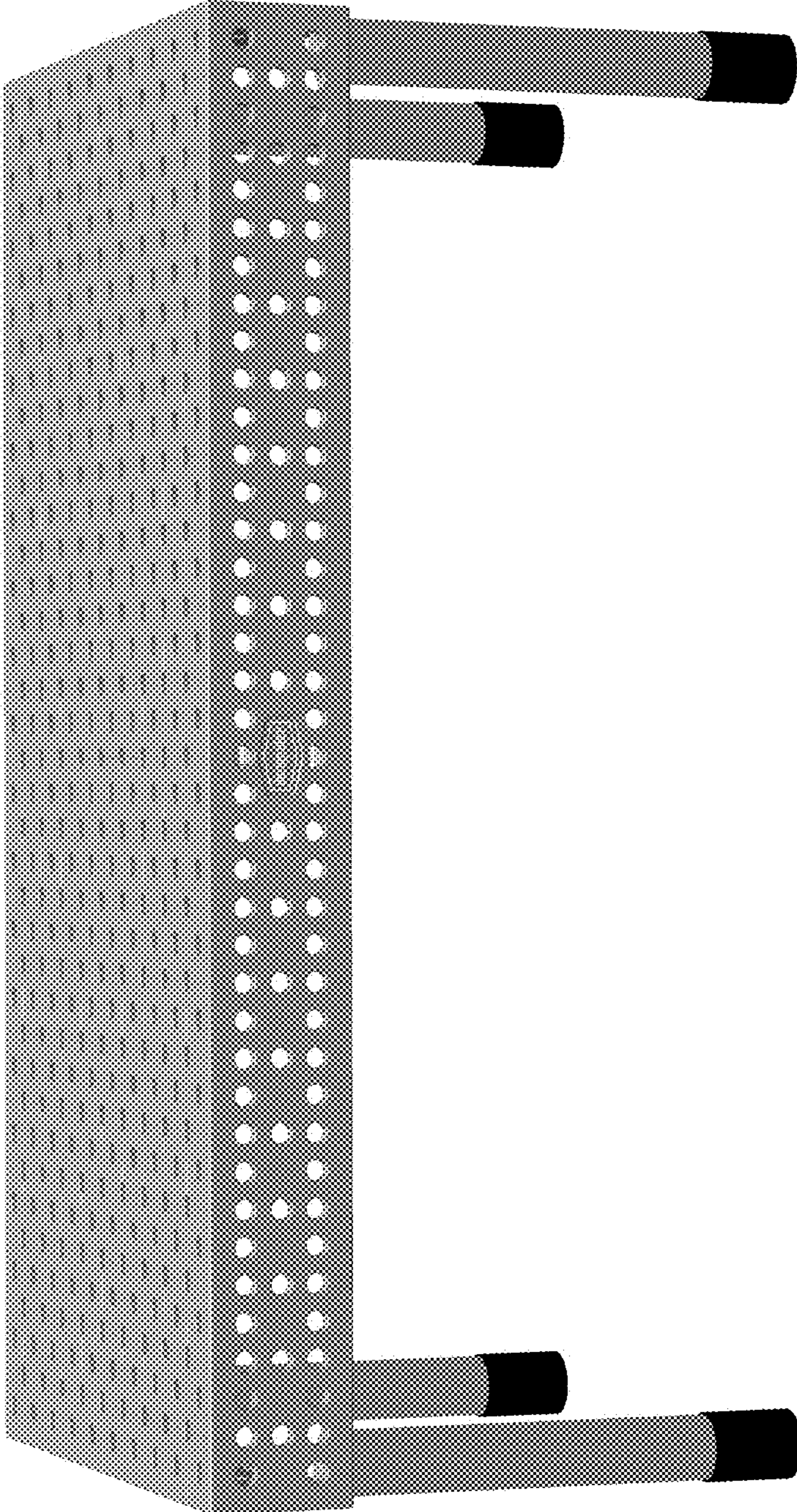

FIG. 9

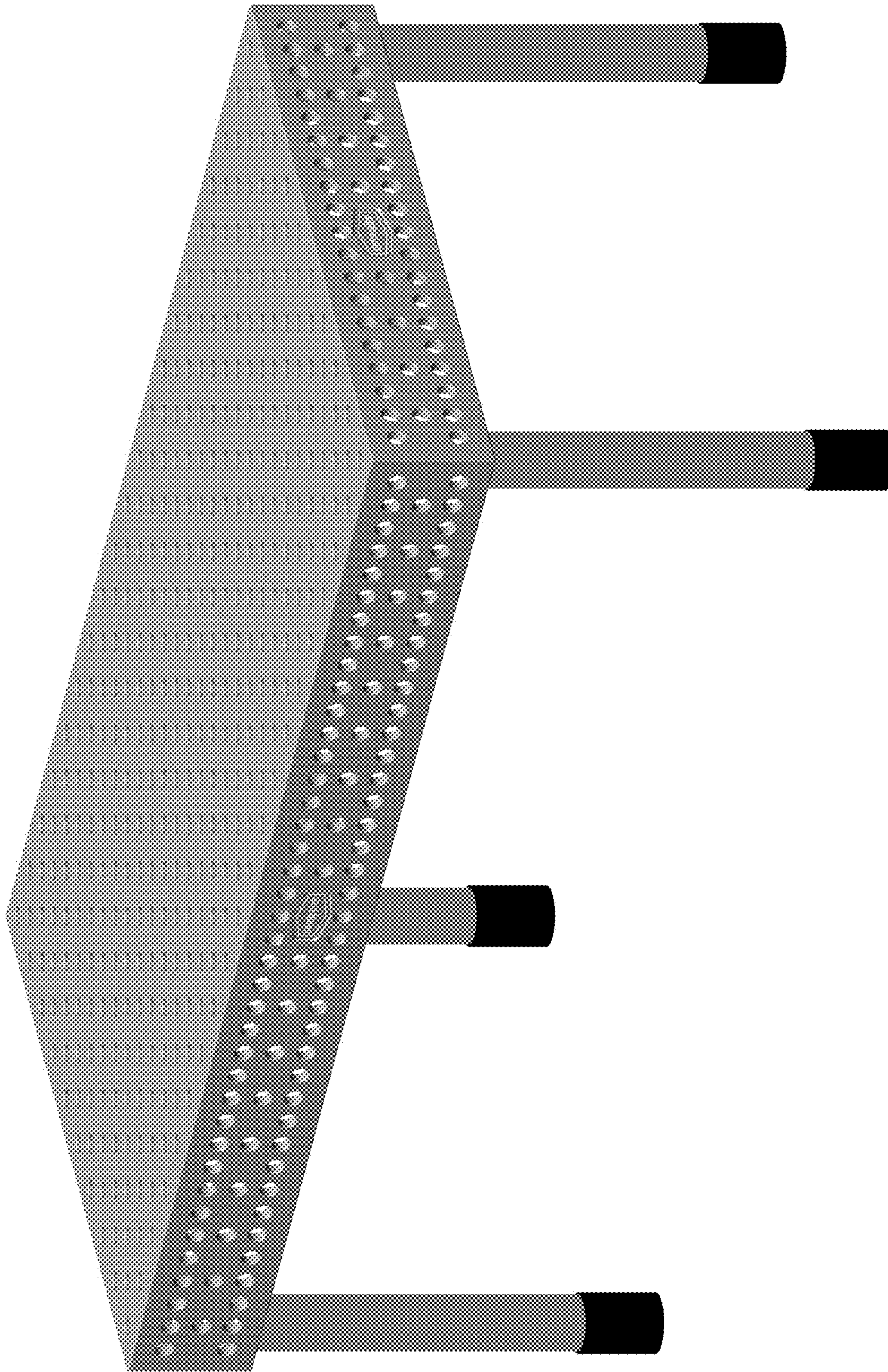

FIG. 10

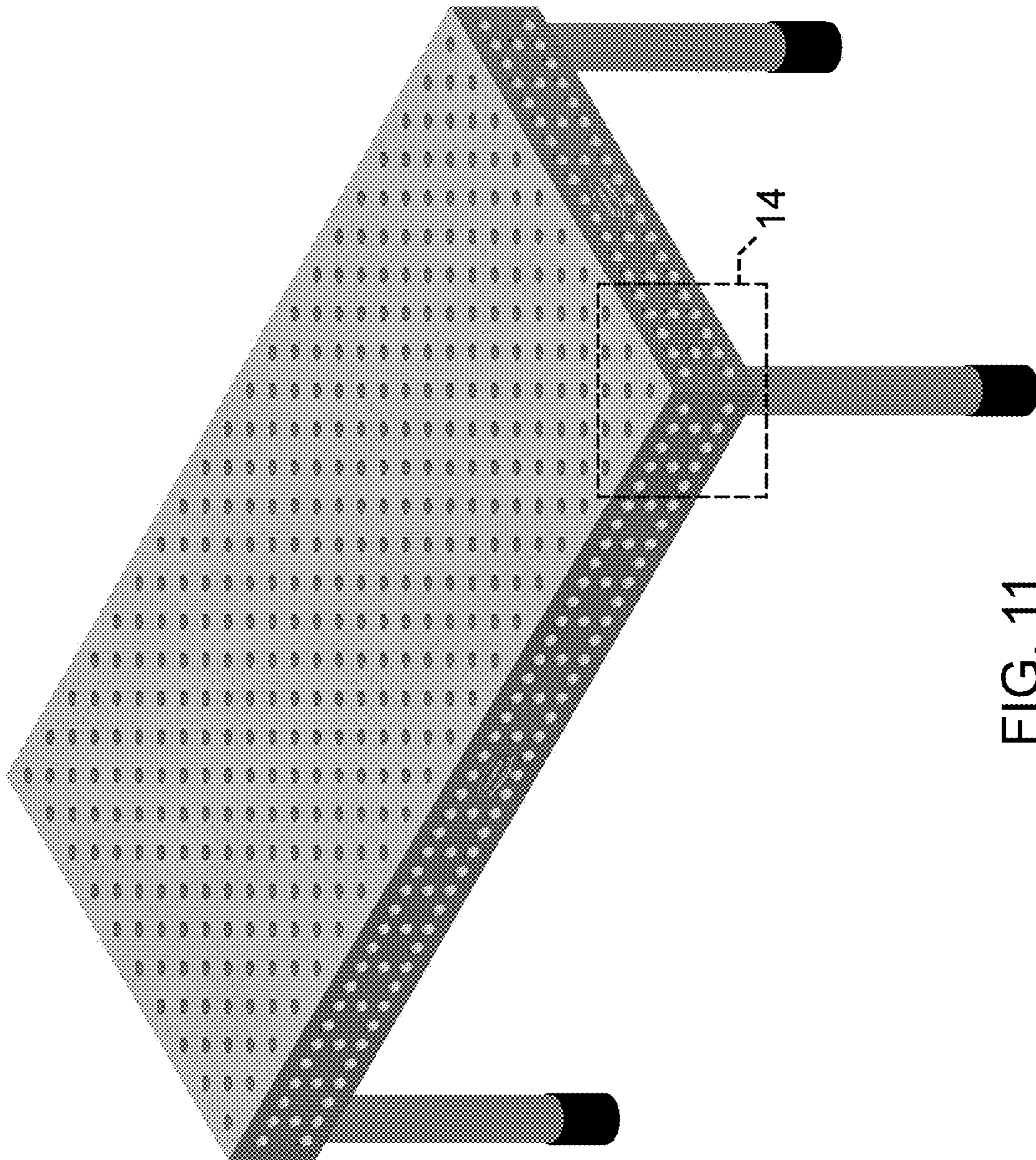

FIG. 11

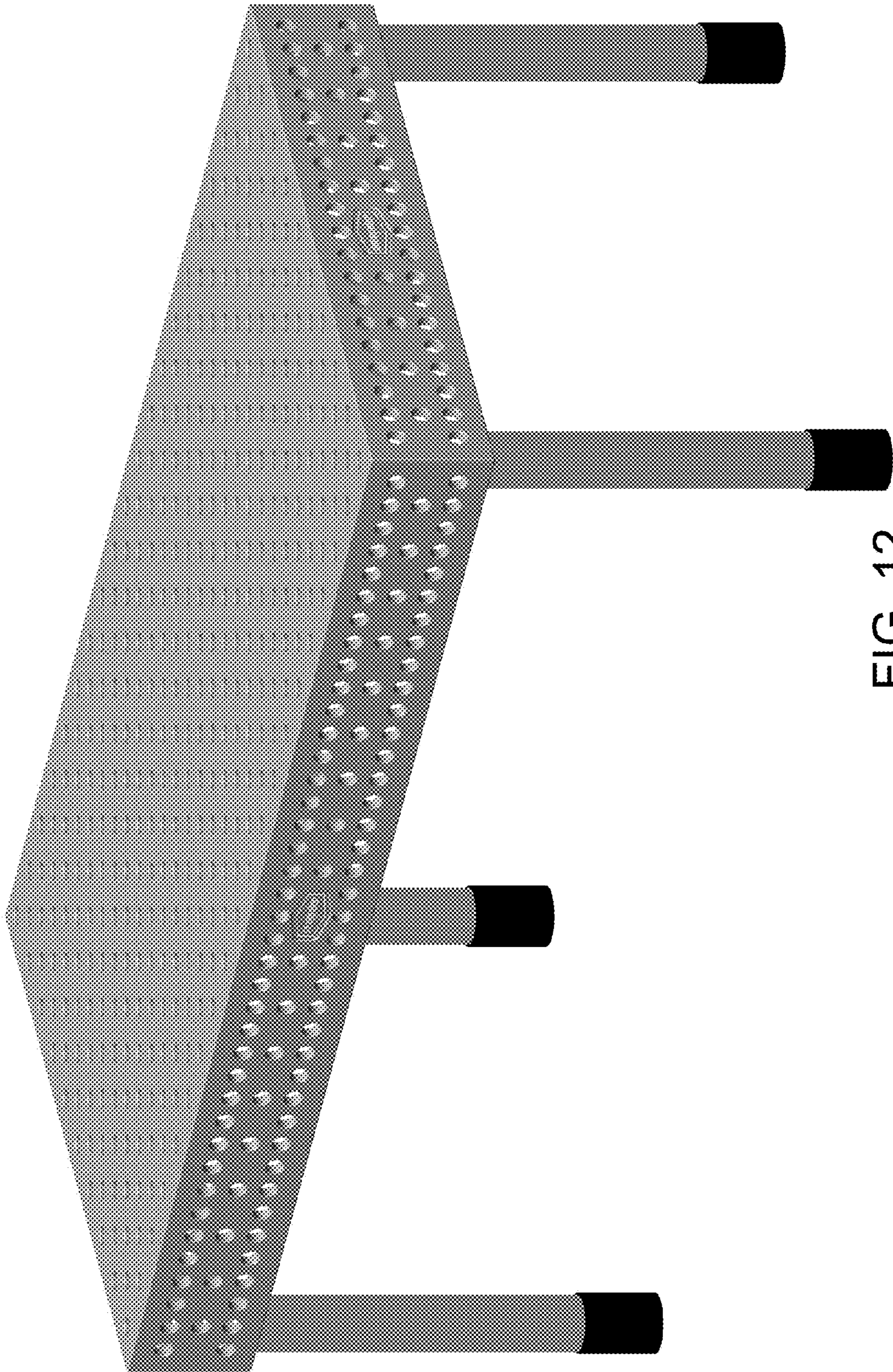

FIG. 12

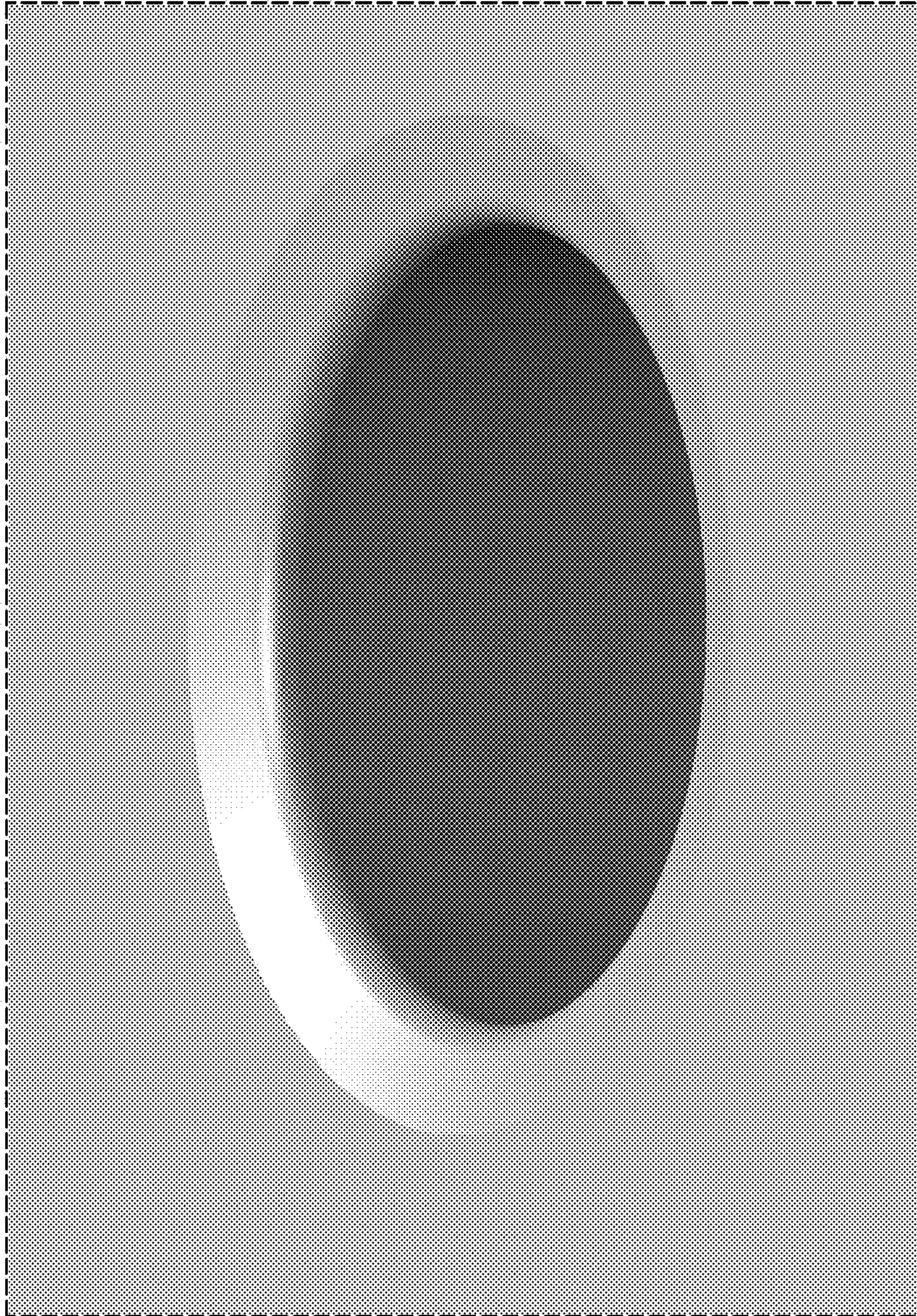

FIG. 13

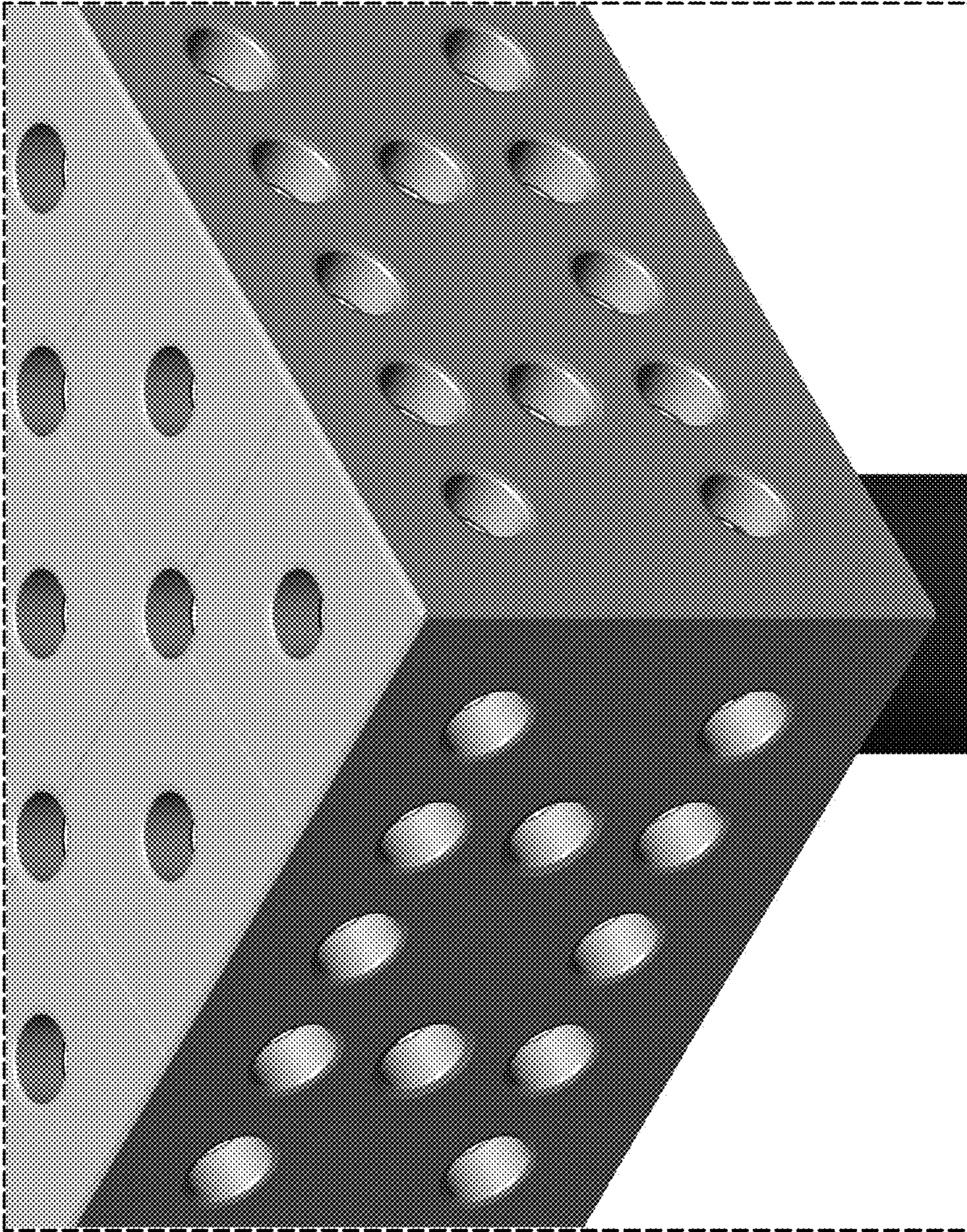

FIG. 14