



US00D773970S

(12) **United States Design Patent**
Kobayashi

(10) **Patent No.:** **US D773,970 S**

(45) **Date of Patent:** **** Dec. 13, 2016**

(54) **MUFFLER COVER FOR MOTORCYCLES**

(71) Applicant: **Kawasaki Jukogyo Kabushiki Kaisha,**
Hyogo (JP)

(72) Inventor: **Mitsuru Kobayashi,** Kobe (JP)

(73) Assignee: **KAWASAKI JUKOGYO**
KABUSHIKI KAISHA (JP)

(**) Term: **14 Years**

(21) Appl. No.: **29/521,240**

(22) Filed: **Mar. 20, 2015**

(30) **Foreign Application Priority Data**

Sep. 25, 2014 (JP) 2014-021176

(51) **LOC (10) Cl.** **12-16**

(52) **U.S. Cl.**
USPC **D12/194**

(58) **Field of Classification Search**
USPC D12/194
CPC F01N 13/082; F01N 13/1805; F01N 13/20
See application file for complete search history.

(56) **References Cited**

U.S. PATENT DOCUMENTS

D463,328 S *	9/2002	Sawabe	D12/126
D548,659 S *	8/2007	Sakata	D12/194
7,318,497 B2 *	1/2008	Okunosono	F01N 13/005
				180/296
2014/0174581 A1 *	6/2014	Shimomura	B60K 13/04
				138/103

OTHER PUBLICATIONS

Japanese Application No. 2014-021176 Decision of Registration and Notice dated Feb. 24, 2015, 2 pages.

“BA-DGO9J” from Yamaha Motor Co., LTD. <http://www.yamaha-motor.jp/mc/lineup/sportsbike/tw225/detail/0002.html#DTL1> 2 pages.

“64900220” from Harley-Davidson Motor Company <http://www.harley-davidson.com/store/screamin-eagle-nightstick-2-into-1-slip-on-muffler> 3 pages.

* cited by examiner

Primary Examiner — Michael A Pratt

(57) **CLAIM**

The ornamental design for a muffler cover for motorcycles, as shown and described.

DESCRIPTION

FIG. 1 is a front elevational view of a muffler cover for motorcycles showing my new design;
FIG. 2 is a rear elevational view thereof;
FIG. 3 is a left side elevational view thereof;
FIG. 4 is a right side elevational view thereof;
FIG. 5 is a top plan view thereof;
FIG. 6 is a bottom plan view thereof; and,
FIG. 7 is a front left perspective view thereof.

The claimed design is a muffler cover for motorcycles, the portions of which are dark-gray-colored in the drawings, and the light-grayed-out portions are illustrative purpose only and form no part of the claimed design.

The dark and light greyed surfaces do not represent a color nor a pattern but are intended to represent shading on the surface of the drawings.

1 Claim, 7 Drawing Sheets

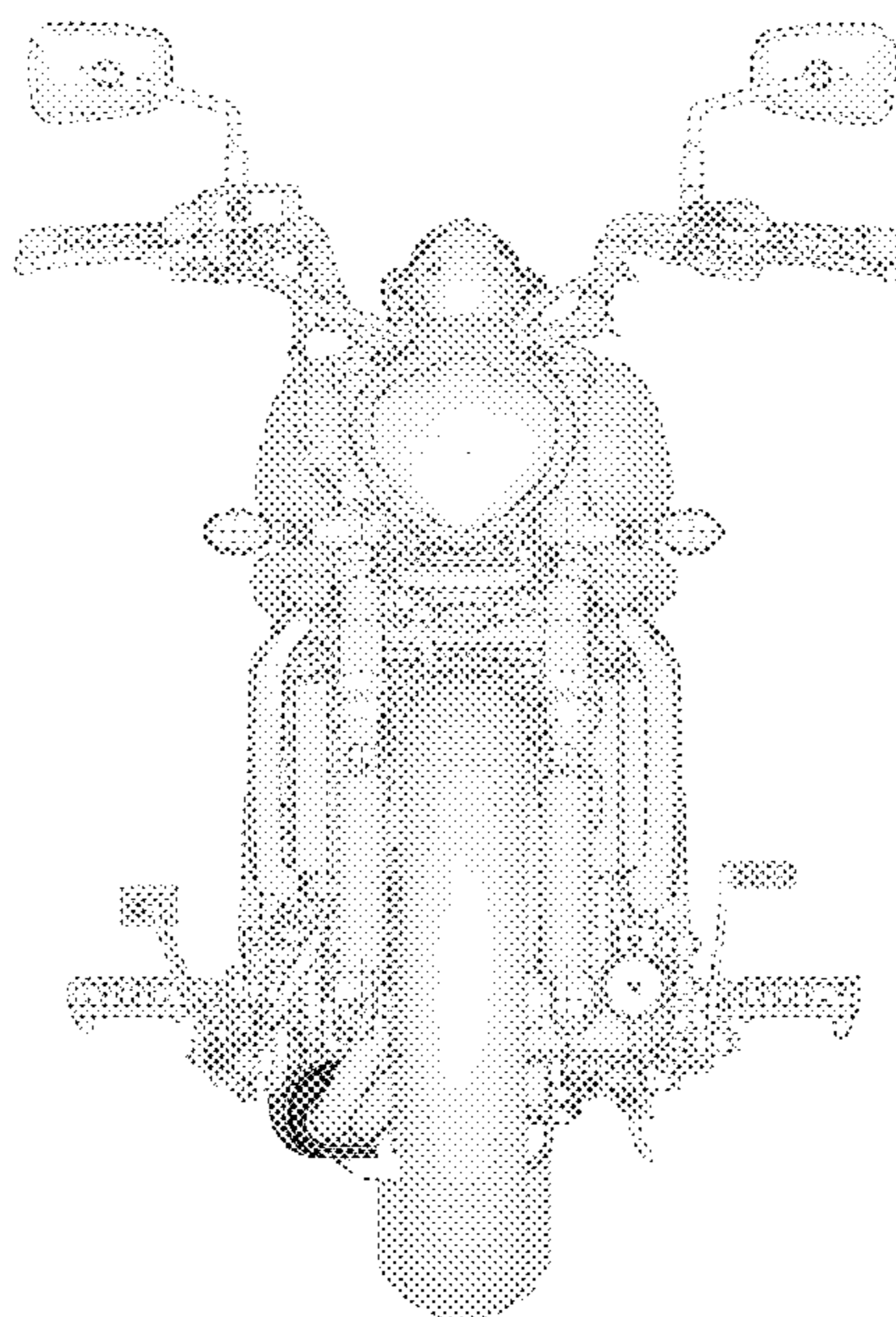

Fig. 1

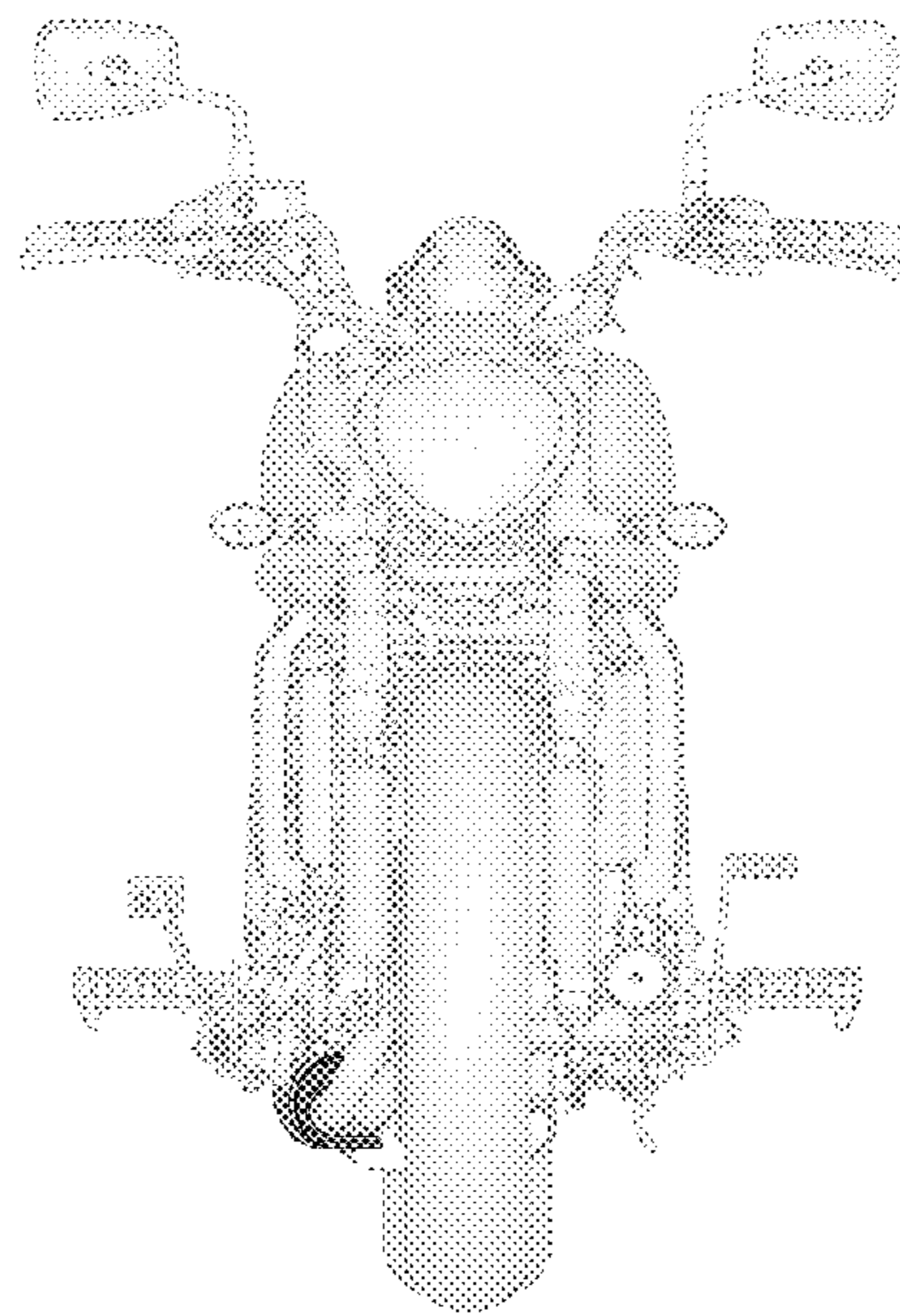
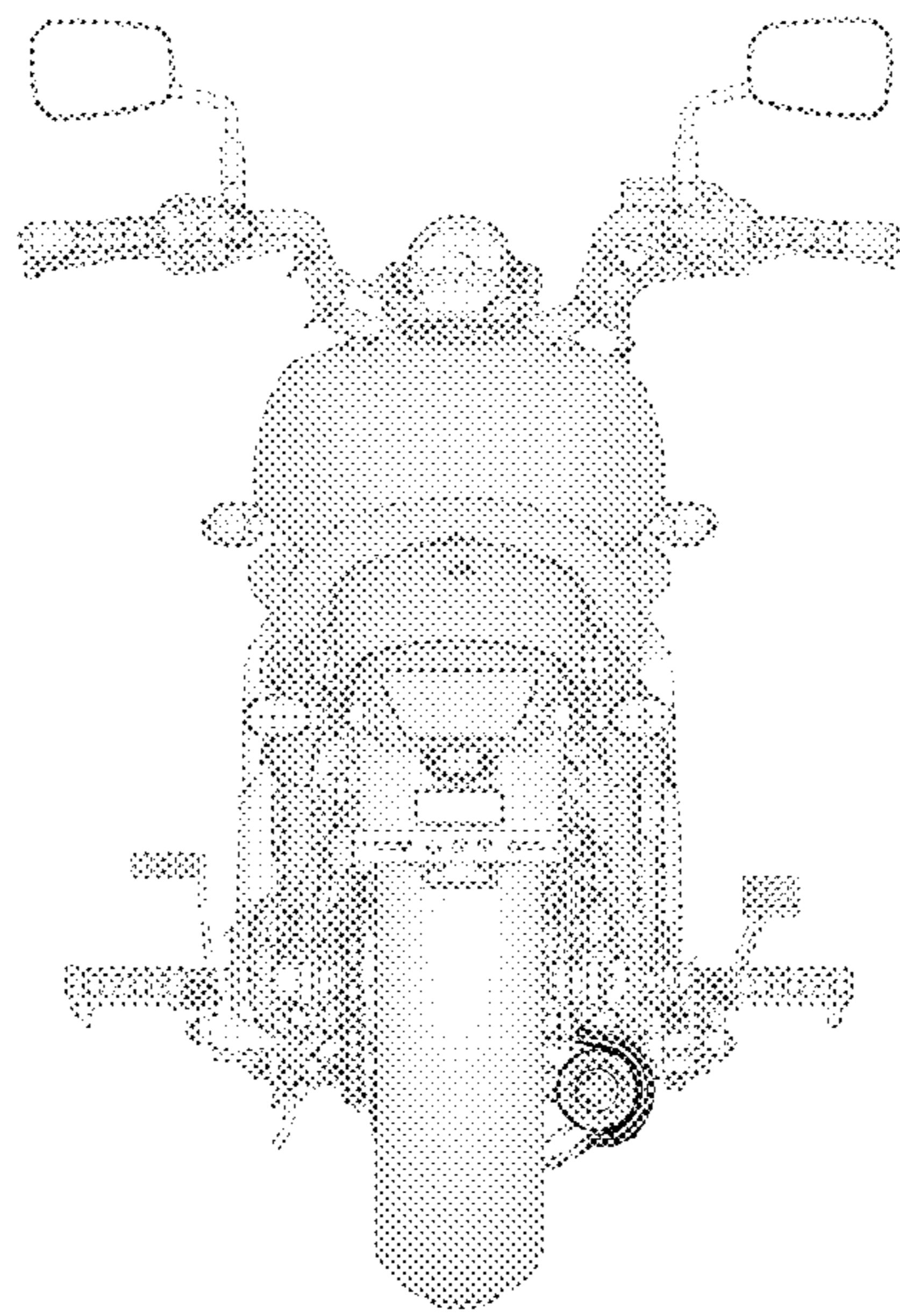

Fig. 2



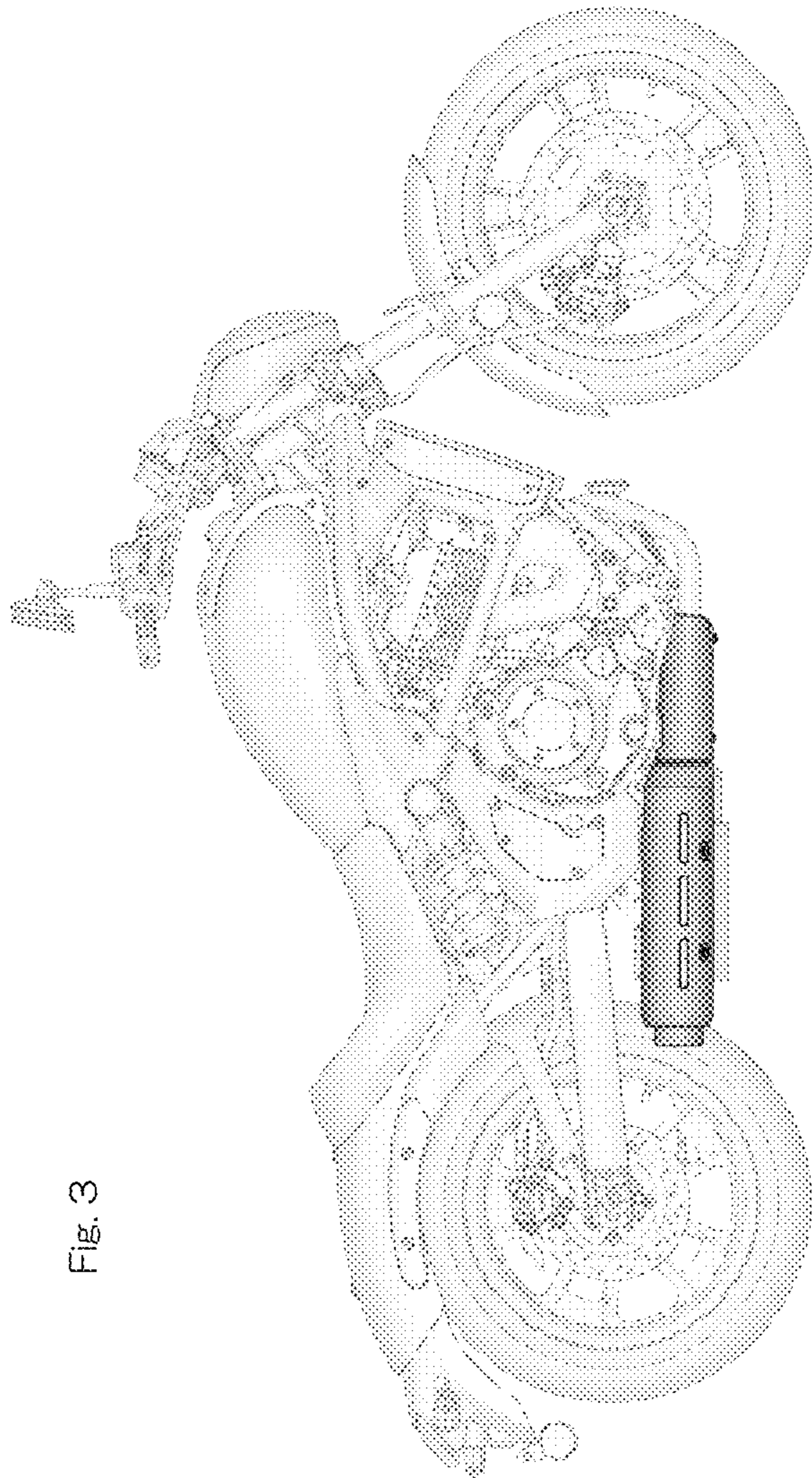

Fig. 3

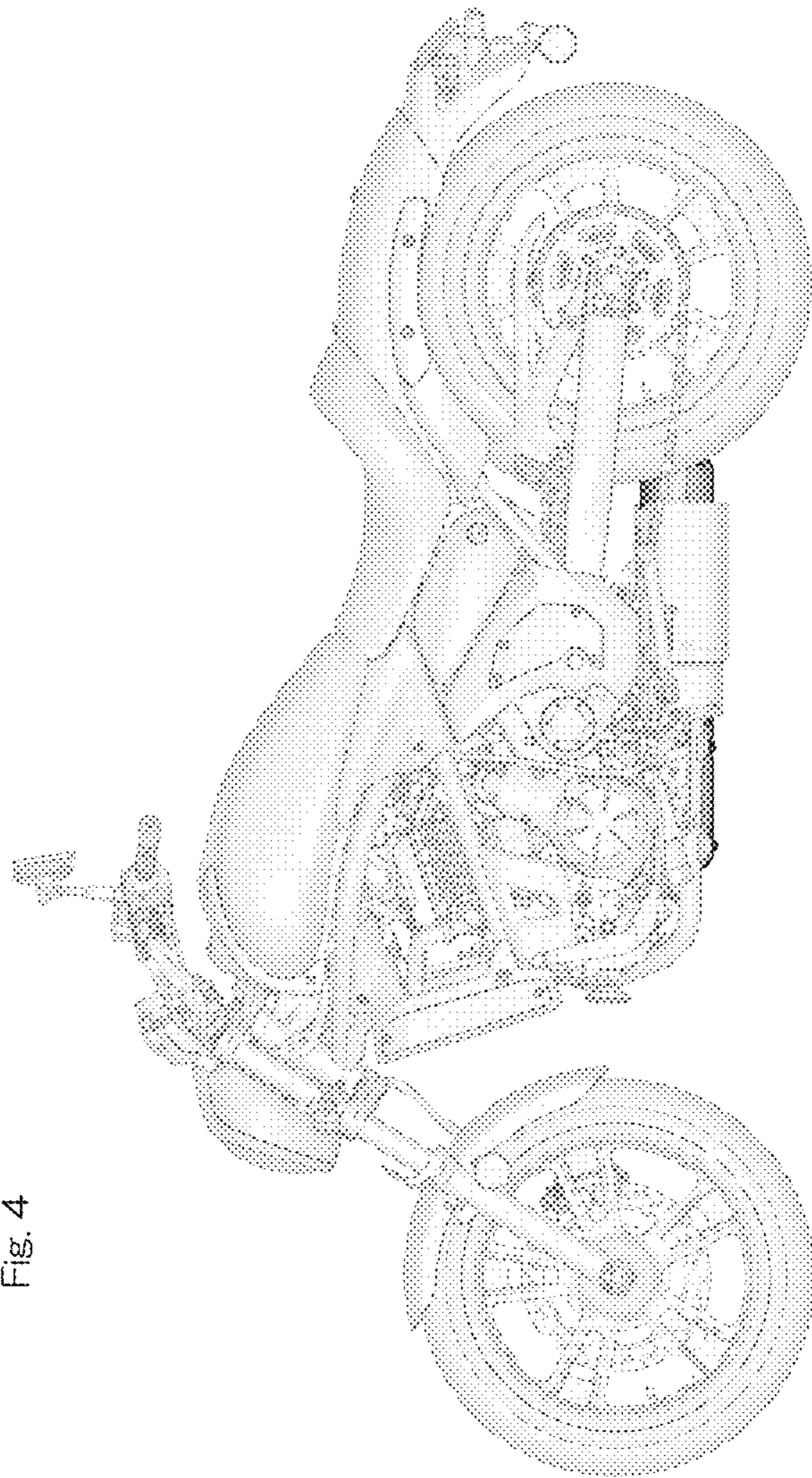

Fig. 4

Fig. 5

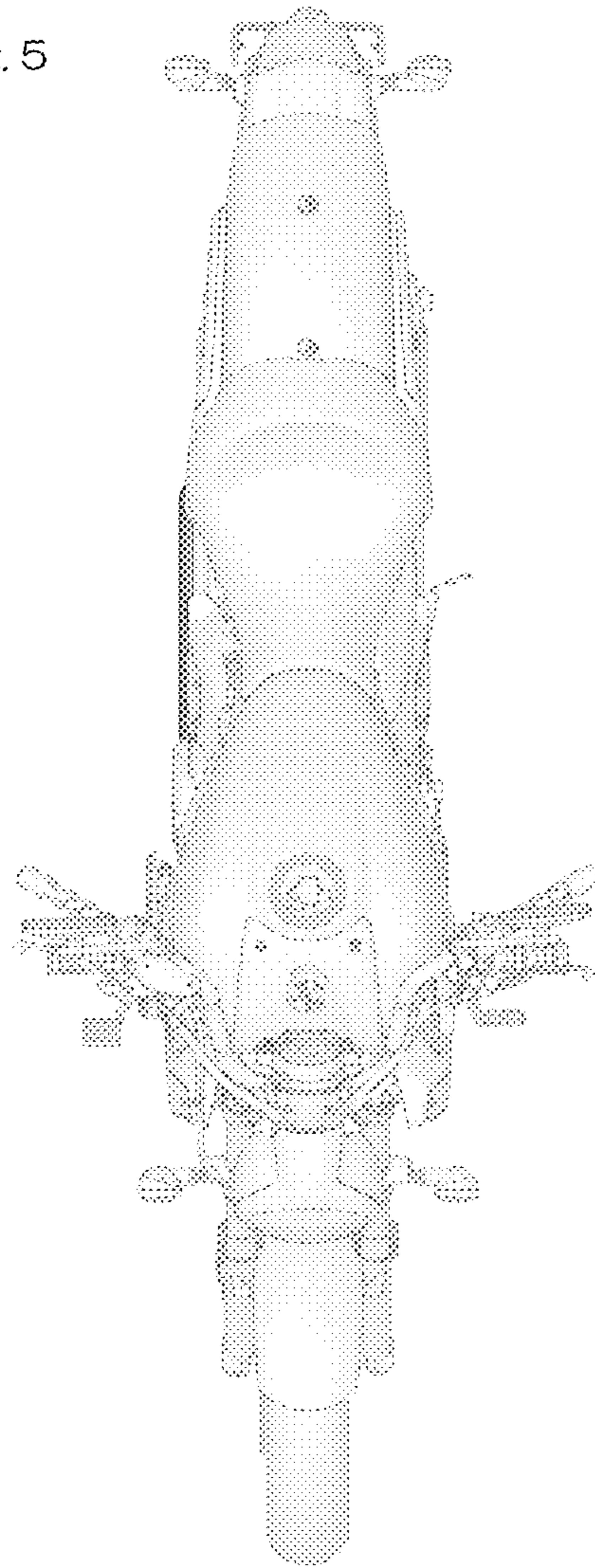
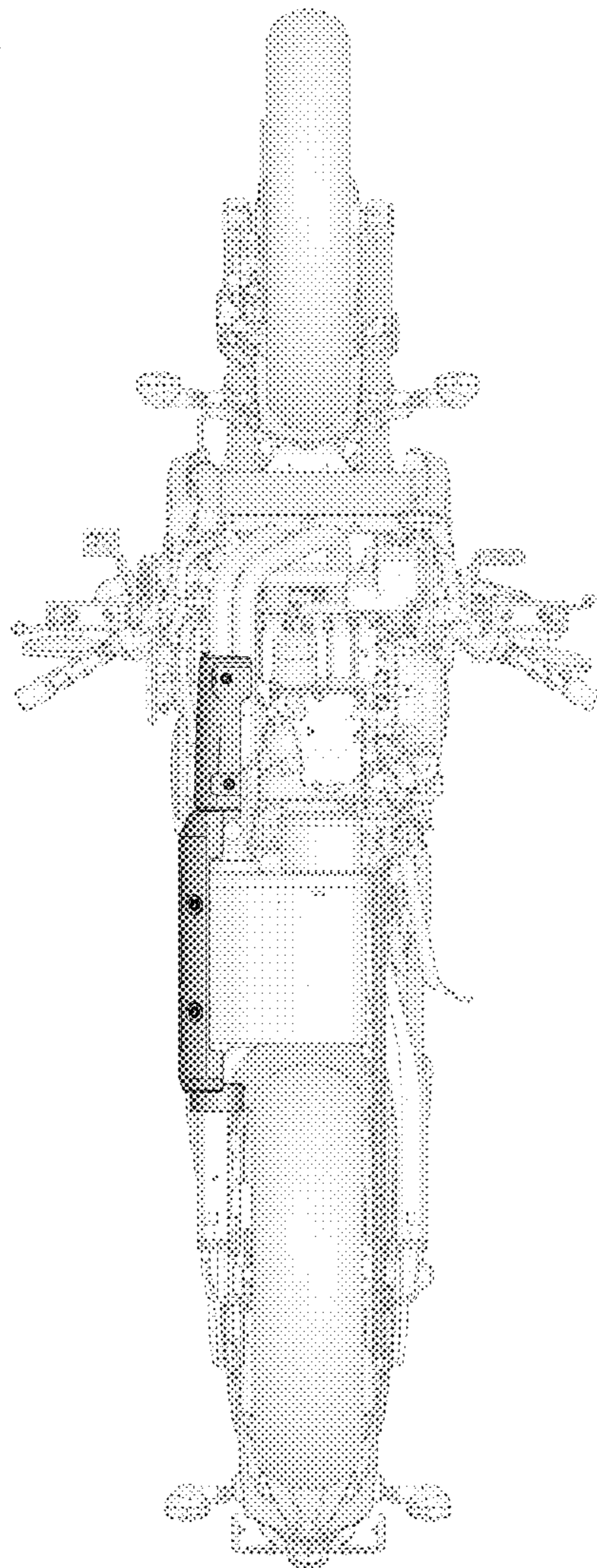

Fig. 6



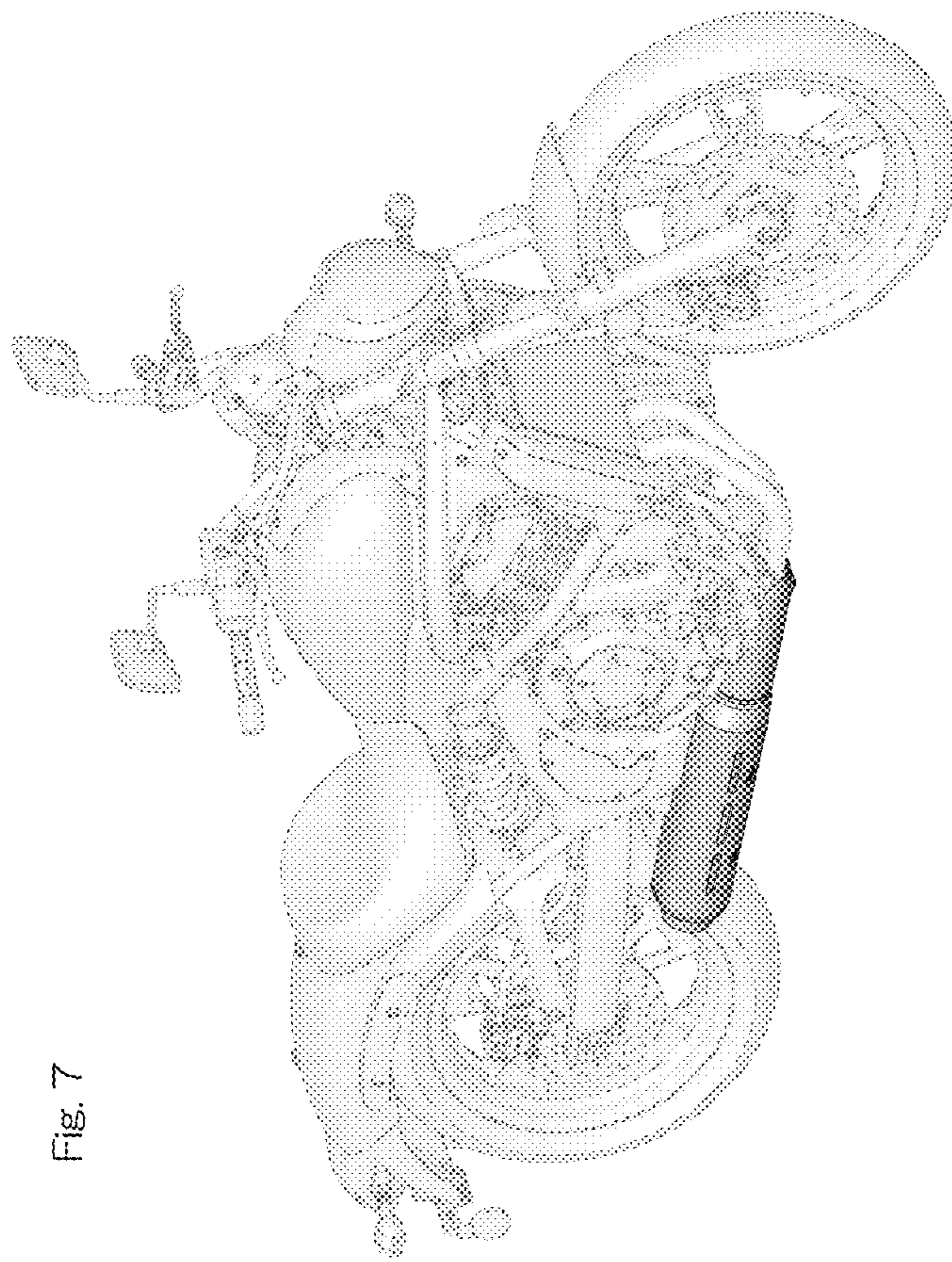

Fig. 7