



US00D773799S

(12) **United States Design Patent**
Haythornthwaite

(10) **Patent No.:** **US D773,799 S**

(45) **Date of Patent:** **** Dec. 13, 2016**

(54) **BUTTON FOR A HANDLE**

(71) Applicant: **Shedrain Corporation**, Portland, OR (US)

(72) Inventor: **David Haythornthwaite**, Fujian Province (CN)

(73) Assignee: **SHEDRAIN CORPORATION**, Portland, OR (US)

(**) Term: **14 Years**

(21) Appl. No.: **29/468,383**

(22) Filed: **Sep. 30, 2013**

(51) **LOC (10) Cl.** **03-03**

(52) **U.S. Cl.**
USPC **D3/12**

(58) **Field of Classification Search**
USPC D3/5, 7-10, 12-18; D10/108;
D13/103-122, 134, 138, 168, 179, 180,
D13/174; D14/218; D21/385; 40/451;
135/24, 135/4.4, 15.1, 17, 24.72, 40, 44,
25.42, 76, 6, 135/65; 345/169; 340/82.24,
12.22, 3.2; 348/14.05, 114, 211.99, 734;
341/22, 176; 455/92, 95, 128,
151.1-151.4, 352, 355
CPC A45B 9/02; A45B 9/00; B25G 1/002
See application file for complete search history.

(56) **References Cited**

U.S. PATENT DOCUMENTS

- 1,583,507 A * 5/1926 Bloem B66B 3/00
362/309
- D349,360 S * 8/1994 Gonsior D10/108
- D477,459 S * 7/2003 Kuo D3/12
- D518,949 S * 4/2006 Wang D3/12
- D550,304 S * 9/2007 Luciano, Jr. D13/174
- D624,524 S * 9/2010 Terzigni D14/167
- D663,642 S * 7/2012 Saikawa D10/108
- D672,727 S * 12/2012 McCullar D13/168

- D699,224 S * 2/2014 Diamond D14/218
- D719,935 S * 12/2014 Diamond D14/218
- D722,045 S * 2/2015 Mok D14/218

(Continued)

OTHER PUBLICATIONS

Eco Parking Sign Double Arrow: Announced Oct. 31, 2011 [online] site visited Sep. 11, 2015. Available from Internet URL: <http://www.zinggreenproducts.com/eco-parking-sign-double-arrow-white-blue-12-x6.html>.*

(Continued)

Primary Examiner — Thomas Johannes

Assistant Examiner — Catherine Posthauer

(74) *Attorney, Agent, or Firm* — Leason Ellis LLP

(57) **CLAIM**

The ornamental design for a button for a handle, as shown and described.

DESCRIPTION

FIG. 1 is a front and top perspective view of a button for a handle showing my new design;
FIG. 2 is a front and bottom perspective view thereof;
FIG. 3 is a left side elevation view thereof;
FIG. 4 is front elevation view thereof;
FIG. 5 is a right side elevation view thereof;
FIG. 6 is a front and top perspective view of a second embodiment of a button for a handle showing my new design;
FIG. 7 is a front and bottom perspective view thereof;
FIG. 8 is a left side elevation view thereof;
FIG. 9 is front elevation view thereof; and,
FIG. 10 is a right side elevation view thereof.

The broken lines shown in various figures are for illustrative purposes only and form no part of the claimed design. The dash-dot-dash broken lines define the boundaries of the claimed design and form no part thereof. The stipple shading, shown in FIGS. 1-10, is being used to show a contrast in the appearance between the button and the surrounding handle portions.

1 Claim, 4 Drawing Sheets

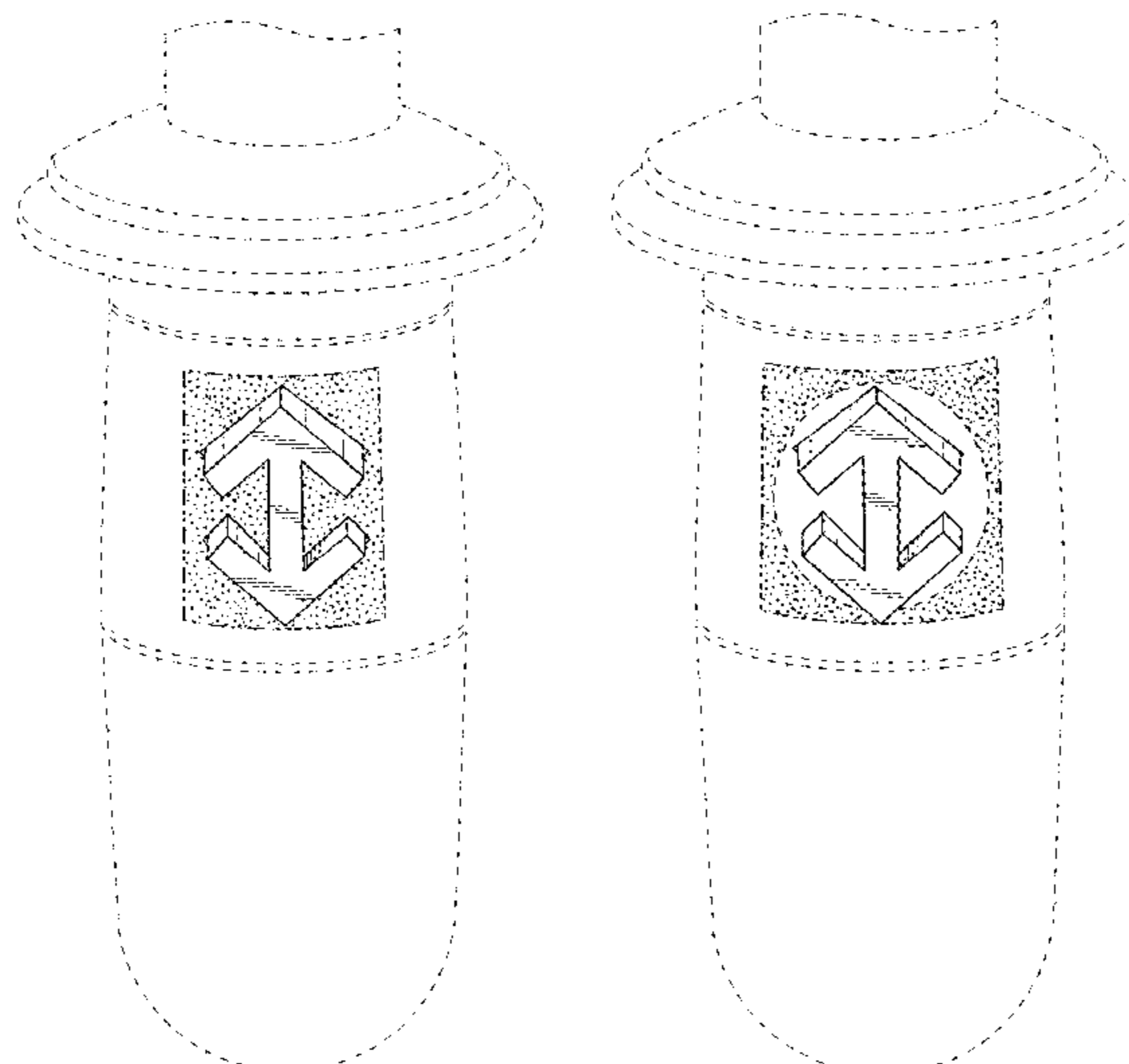

(56)

References Cited

U.S. PATENT DOCUMENTS

D726,196 S * 4/2015 van Os D14/485
D729,273 S * 5/2015 Mariet D14/491
2004/0025914 A1* 2/2004 Kuo A45B 25/16
135/24

OTHER PUBLICATIONS

Universal DC 12V 20A Auto Car Power Window Switch:
Announced [May 4, 2013] online, site visited [Sep. 11, 2015].
Available from Internet URL: <http://www.ebay.com/itm/Universal-DC-12V-20A-Auto-Car-Power-Window-Switch-5-pin-ON-OFF-Spst-Swing-BLACK-/221793182202>.*

Vector Arrows: Announced Jan. 12, 2012 [online], site visited Sep. 17, 2015. Available from Internet URL: <http://design.tutsplus.com/articles/350-free-graphics-vector-arrow-symbols-and-shapes--vector-5210>.*

Left-Right Arrow Icons: Site visited Sep. 17, 2015. Available from Internet URL: <http://icons.mysitemyway.com/legacy/icon-tags/double-arrows/page/21/>.*

Left-Right Arrow Icon: Announced Mar. 27, 2007 [online], site visited [Sep. 17, 2015]. Available from Internet URL: <https://openclipart.org/detail/3677/arrow-leftright>.*

Double Ended Arrow: Announced May 22, 2012 [online], site visited [Sep. 17, 2015]. Available from Internet URL: <http://txcowboydancer.com/clip-art-from-microsoft/double-ended-arrow-blue/>.*

2 Sided Arrow Illustration Icons: Announced [as early as Jan. 14, 2012], online. Available from Internet URL: http://www.shutterstock.com/pic-273417827/stock-vector--side-arrow-illustration-icon.html?src=pp-same_artist-268732544-dzMABYHtio93fkFWAyugDg-1.*

Corel Draw 7 (Symbols). Oct. 21, 2008. p. 71.

* cited by examiner

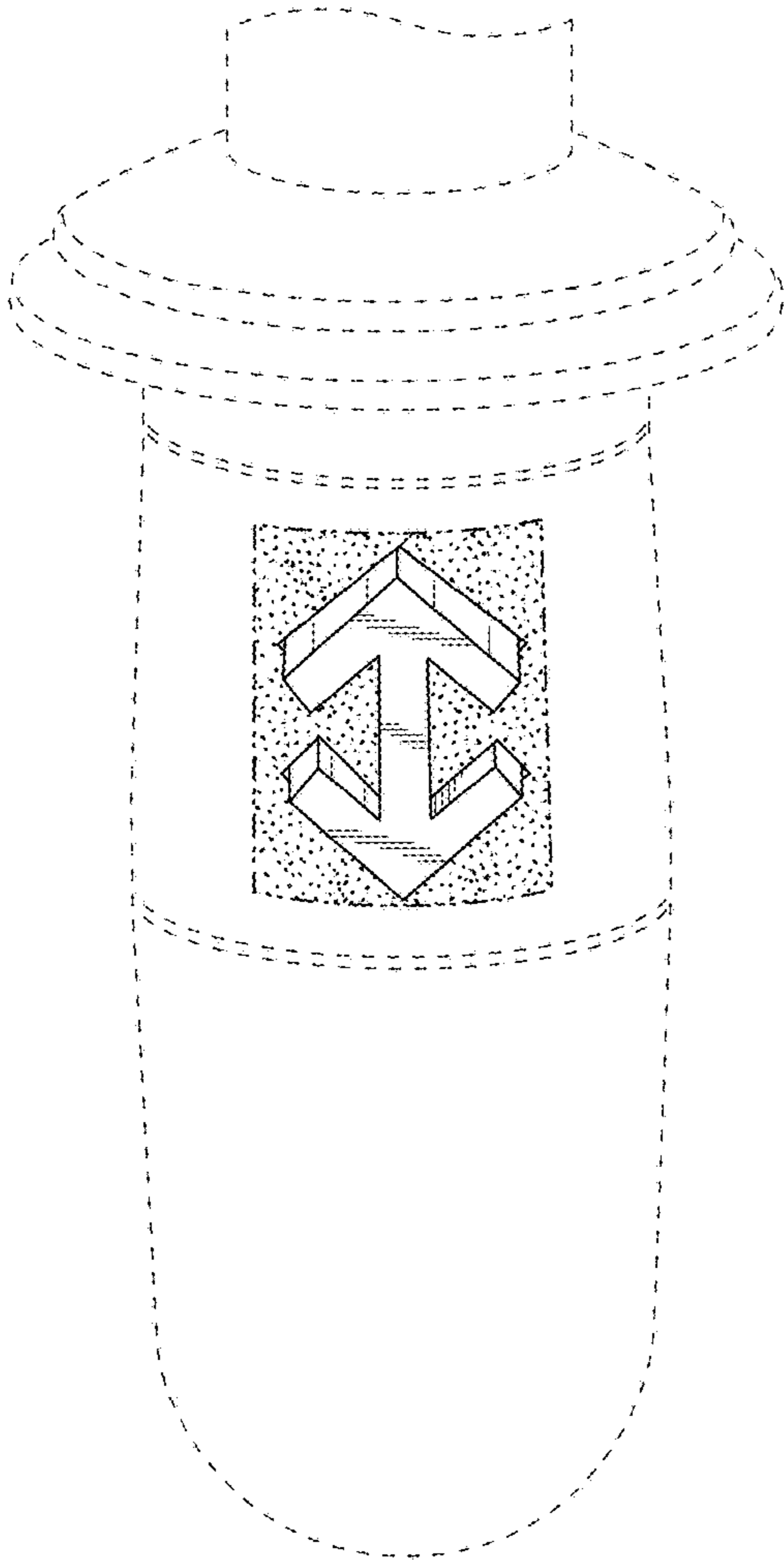

FIG. 1

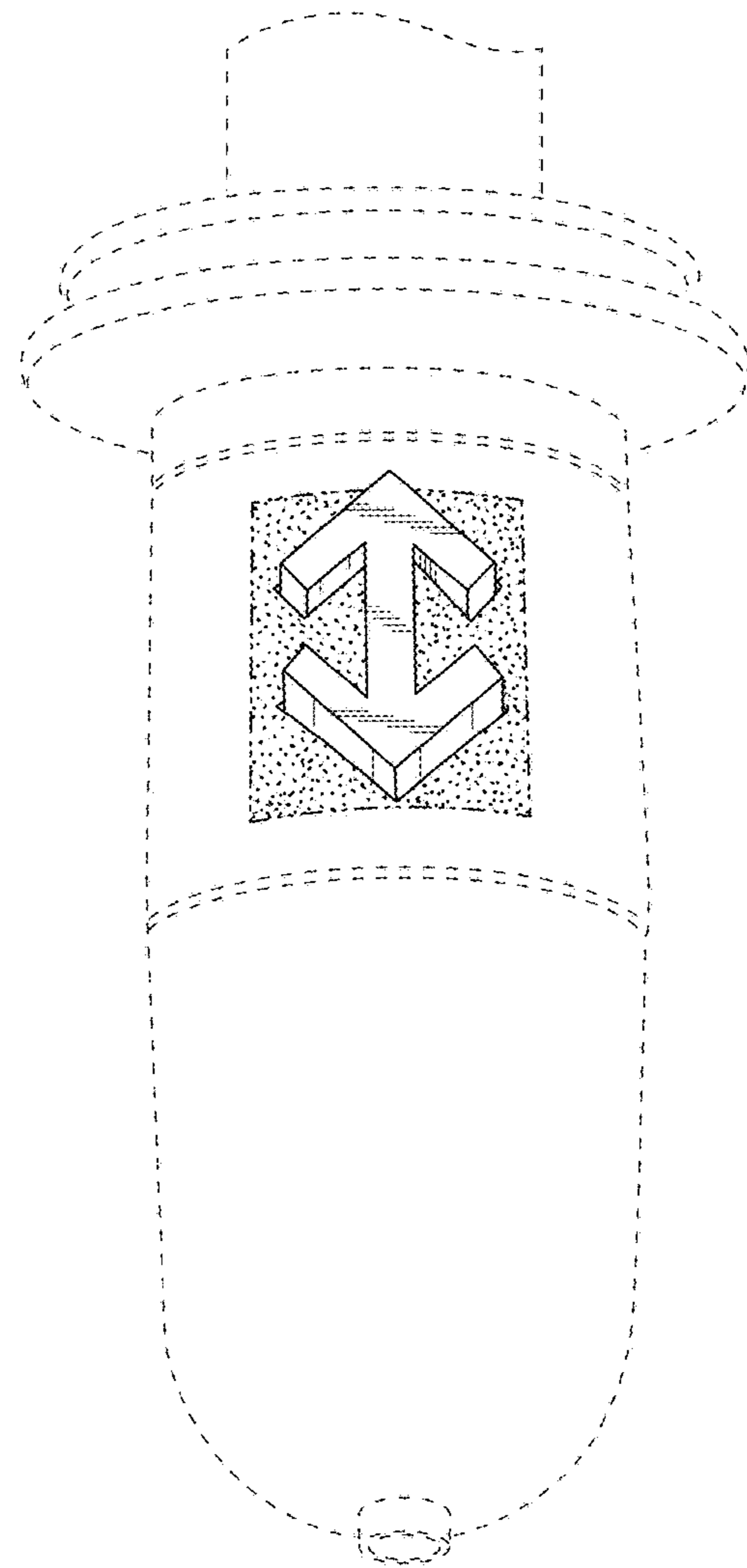

FIG. 2

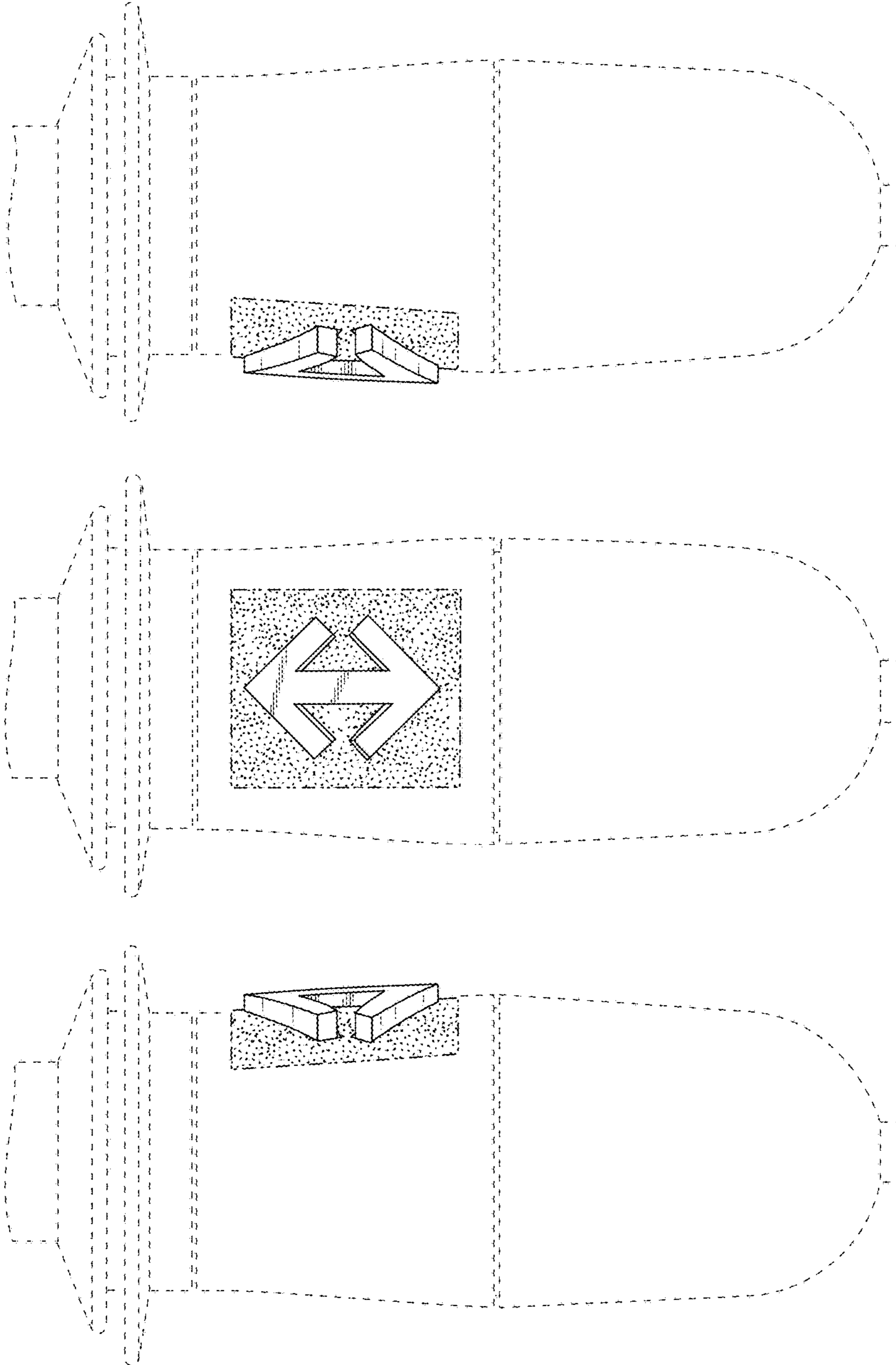

FIG. 5

FIG. 4

FIG. 3

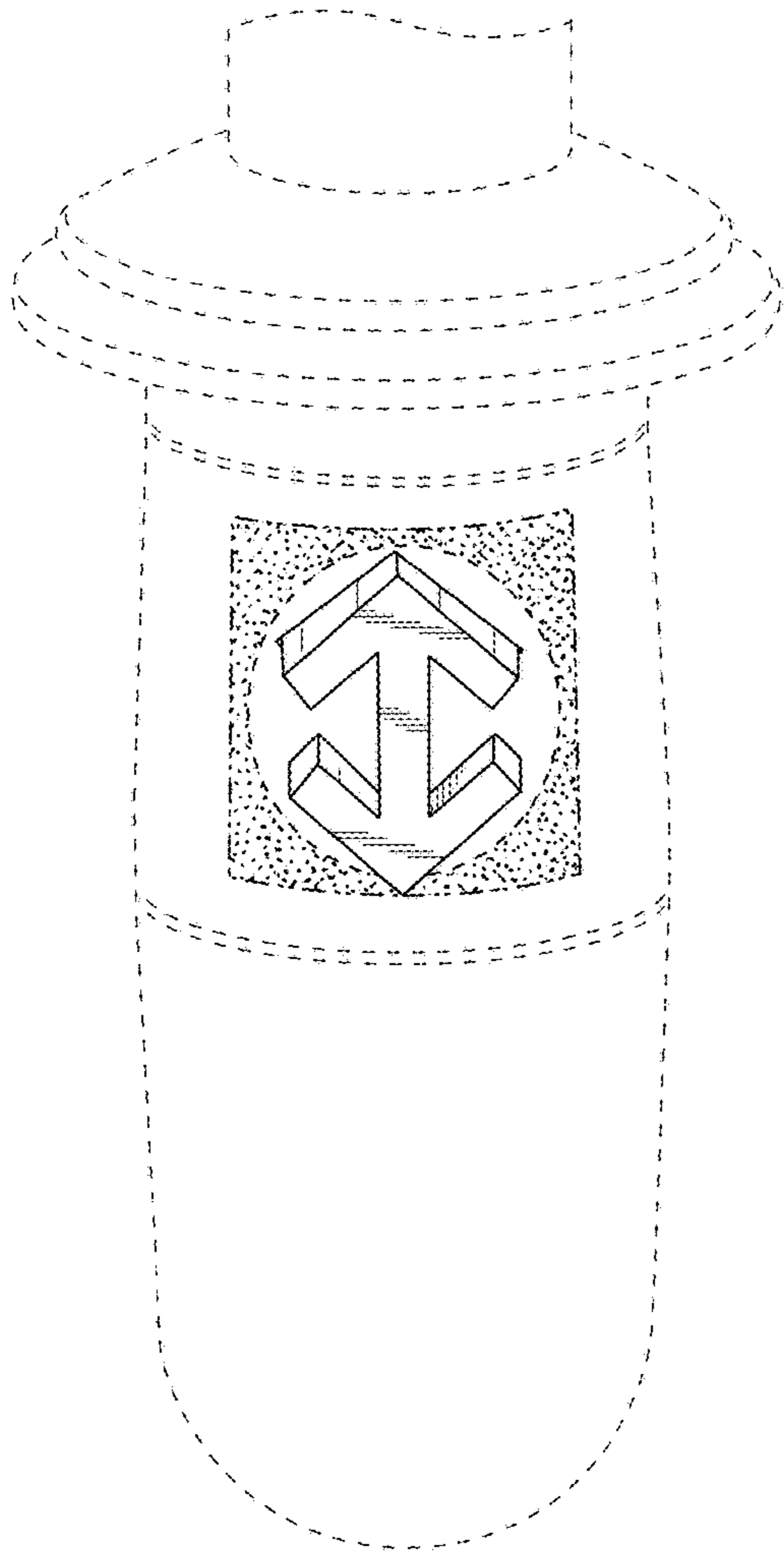

FIG. 6

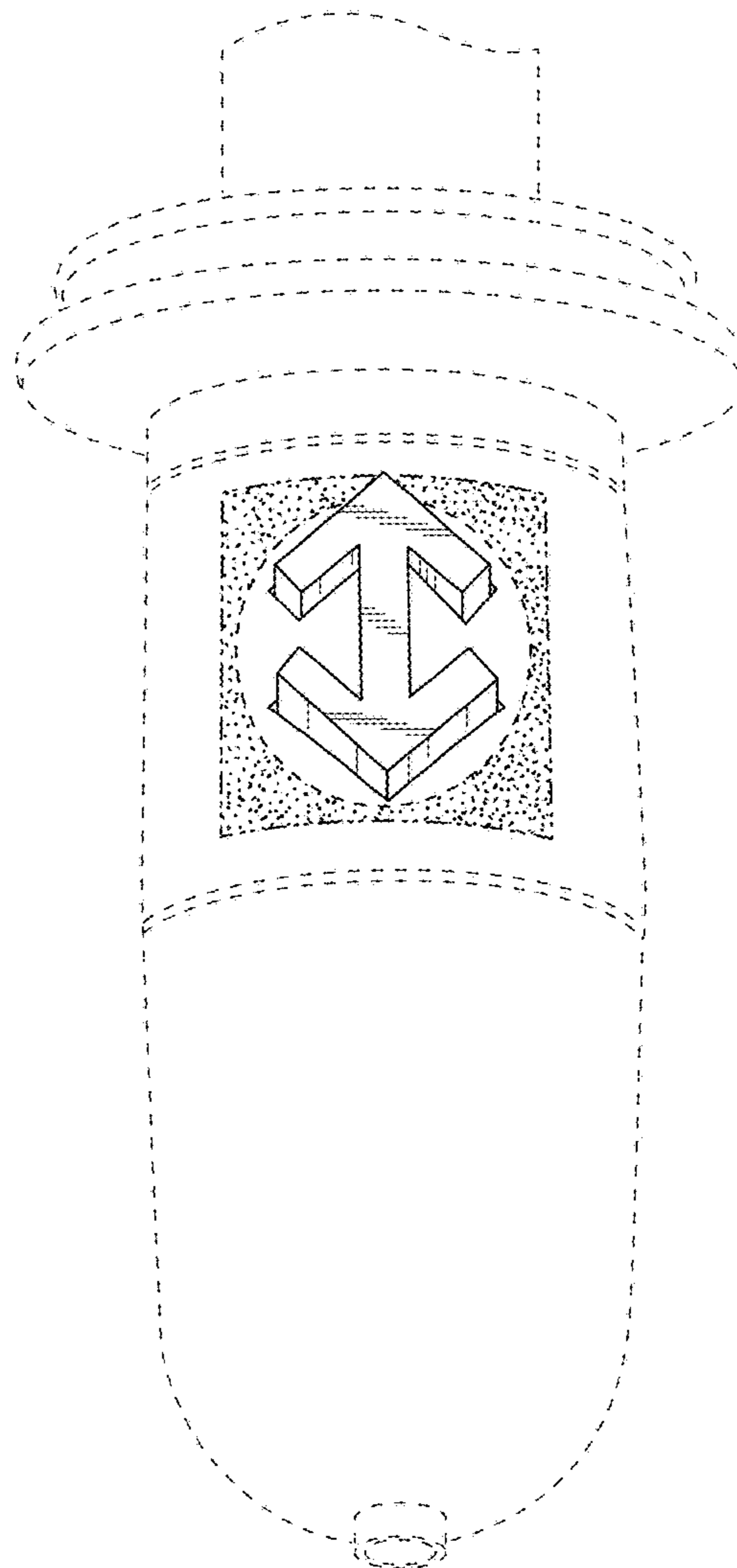

FIG. 7

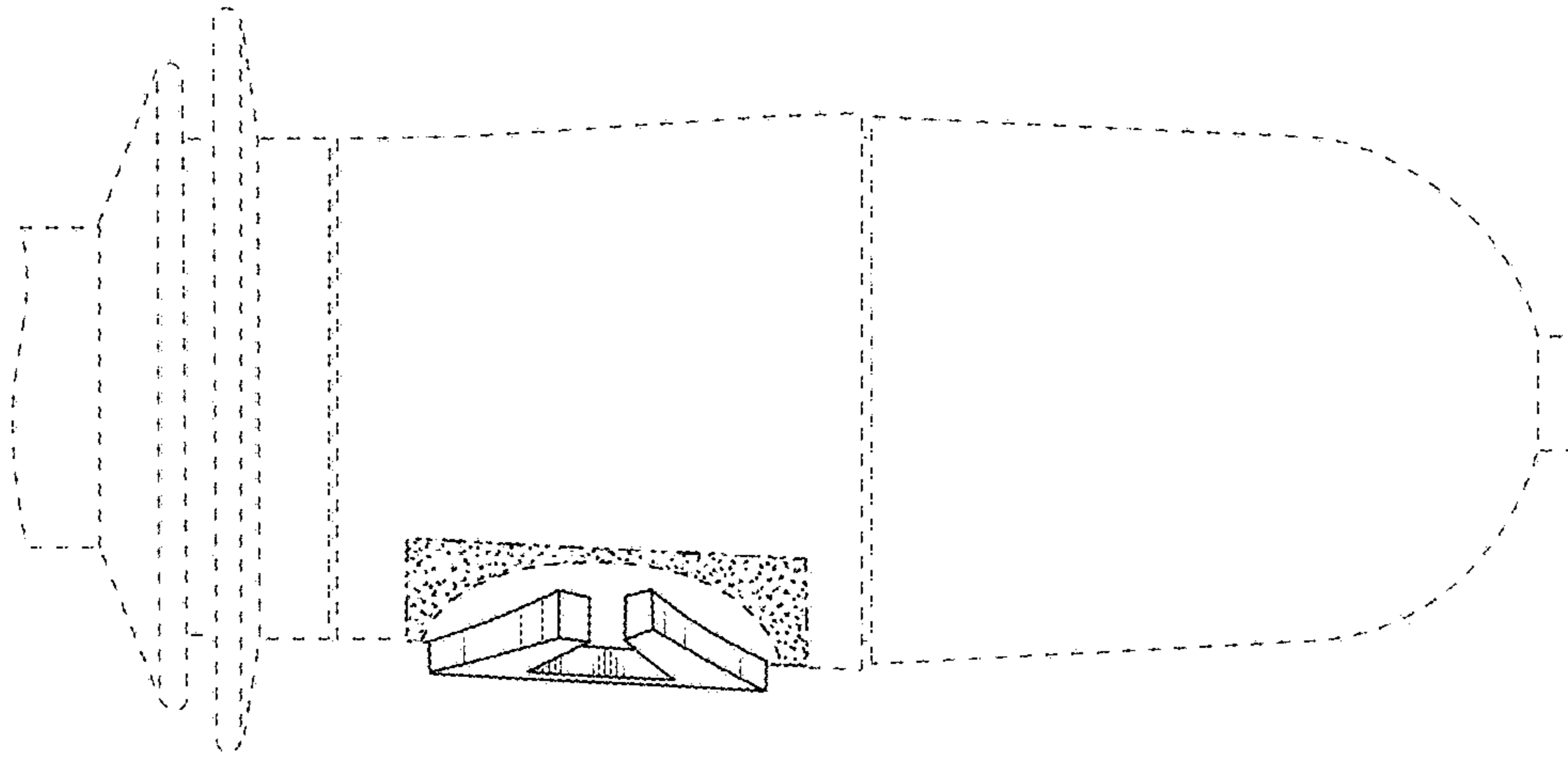

FIG. 8

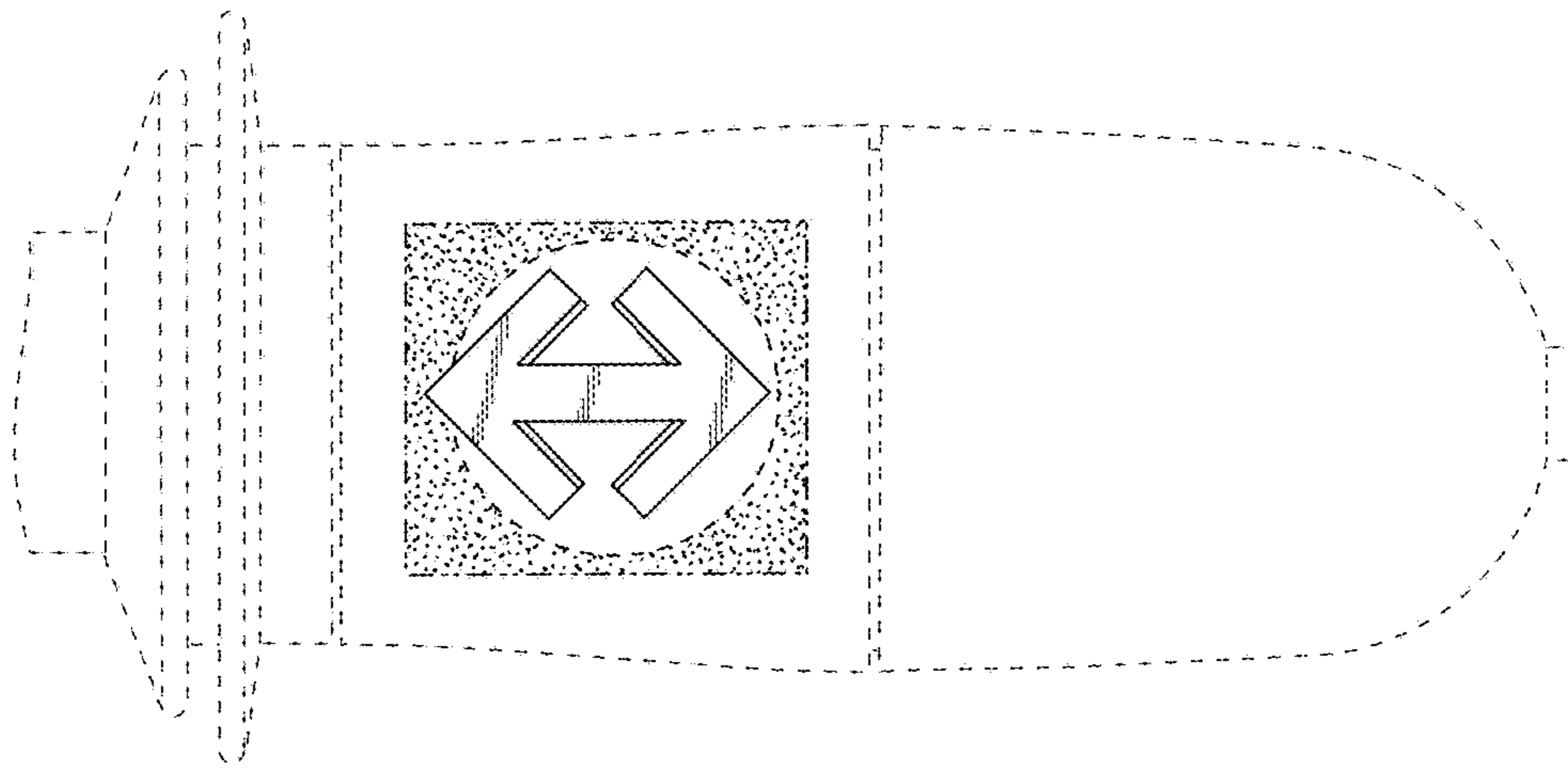

FIG. 9

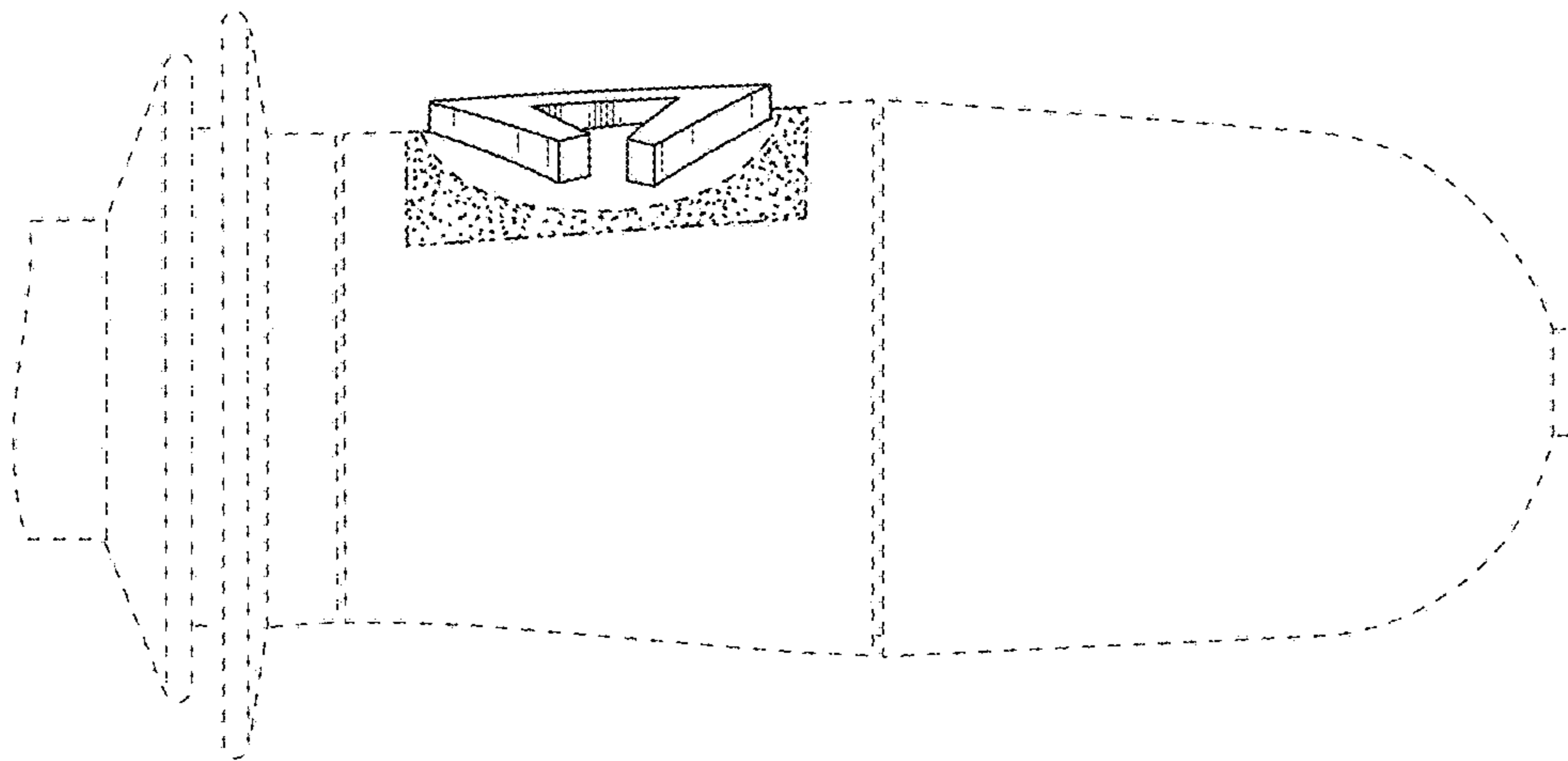

FIG. 10