



US00D773715S

(12) **United States Design Patent**
Sonneman

(10) **Patent No.:** **US D773,715 S**
(45) **Date of Patent:** **** Dec. 6, 2016**

- (54) **CIRCULAR LIGHTING FIXTURE**
- (71) Applicant: **Robert A. Sonneman**, Mamaroneck, NY (US)
- (72) Inventor: **Robert A. Sonneman**, Mamaroneck, NY (US)
- (**) Term: **15 Years**
- (21) Appl. No.: **29/565,270**
- (22) Filed: **May 19, 2016**

D499,507 S *	12/2004	Parres	D26/143
D520,669 S *	5/2006	Brunner	D26/81
D659,882 S *	5/2012	Sterling	D26/83
D660,510 S *	5/2012	Bracher	D26/143
D666,760 S *	9/2012	Arola Ferrer	D26/84
D671,670 S *	11/2012	Sonneman	D26/90
D687,589 S *	8/2013	Wick	D26/90
D725,306 S *	3/2015	Salvagno	D26/84
2009/0213581 A1 *	8/2009	Gauger	F21S 8/065 362/161
2012/0257388 A1 *	10/2012	Bracher	F21S 8/061 362/249.01
2015/0338038 A1 *	11/2015	Feit	F21S 8/061 362/147

* cited by examiner

Related U.S. Application Data

- (63) Continuation of application No. 29/551,224, filed on Jan. 12, 2016.
- (51) **LOC (10) Cl.** **26-03**
- (52) **U.S. Cl.**
USPC **D26/84**
- (58) **Field of Classification Search**
USPC D26/81-91, 143, 144
CPC F21S 8/04; F21S 8/043; F21S 8/046;
F21S 8/06; F21S 8/061; F21S 8/063; F21S
8/065
See application file for complete search history.

Primary Examiner — Clare E Heflin

(74) *Attorney, Agent, or Firm* — Gottlieb, Rackman & Reisman P.C.

(57) **CLAIM**

The ornamental design for a circular lighting fixture, as shown and described.

DESCRIPTION

FIG. 1 is a perspective view of the circular lighting fixture showing my new design;
 FIG. 2 is a top plan view thereof;
 FIG. 3 is a front elevational view thereof, the rear elevational view being a mirror image;
 FIG. 4 is a right side elevational view thereof, the left side being a mirror image; and,
 FIG. 5 is a bottom plan view thereof.
 The broken lines in the drawings are included for the purpose of illustrating portions of the article that form no part of the claimed design.

1 Claim, 5 Drawing Sheets

(56) **References Cited**

U.S. PATENT DOCUMENTS

2,222,980 A *	11/1940	MacFadden	F21S 8/06 362/282
D317,058 S *	5/1991	Sonneman	D26/92
D320,465 S *	10/1991	Sonneman	D26/86
D490,557 S *	5/2004	Cuevas	D26/142
D498,870 S *	11/2004	Parres	D26/81

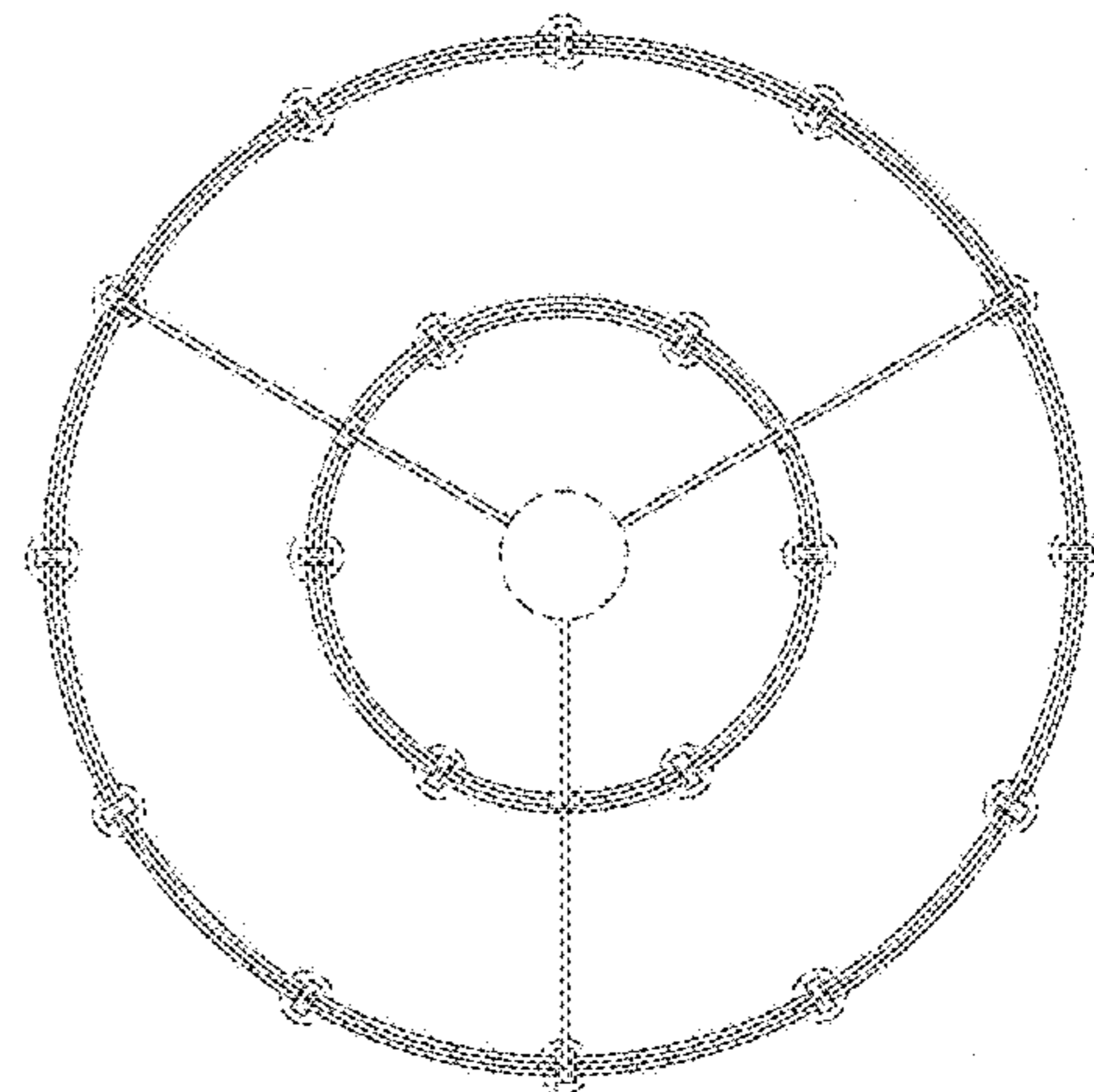
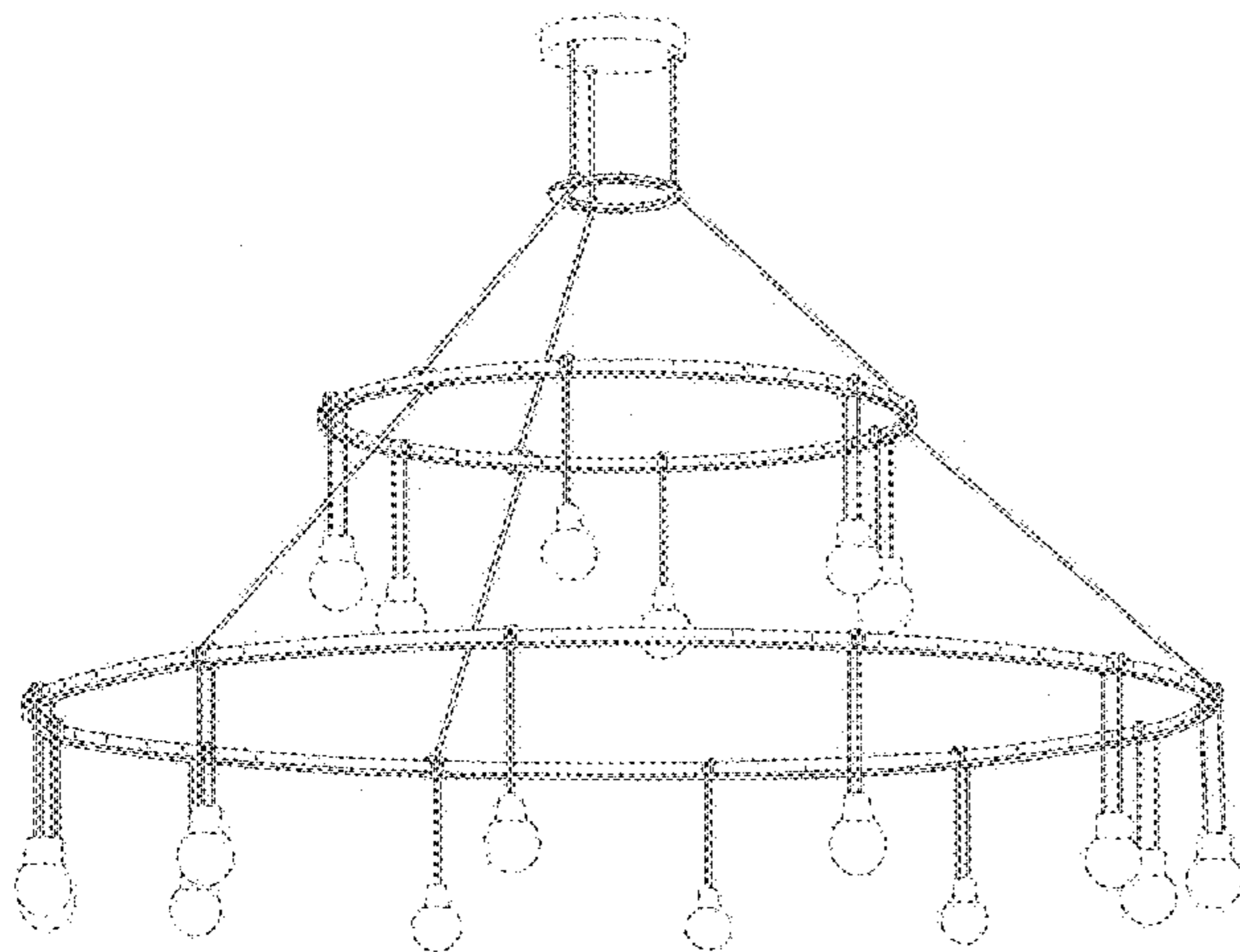
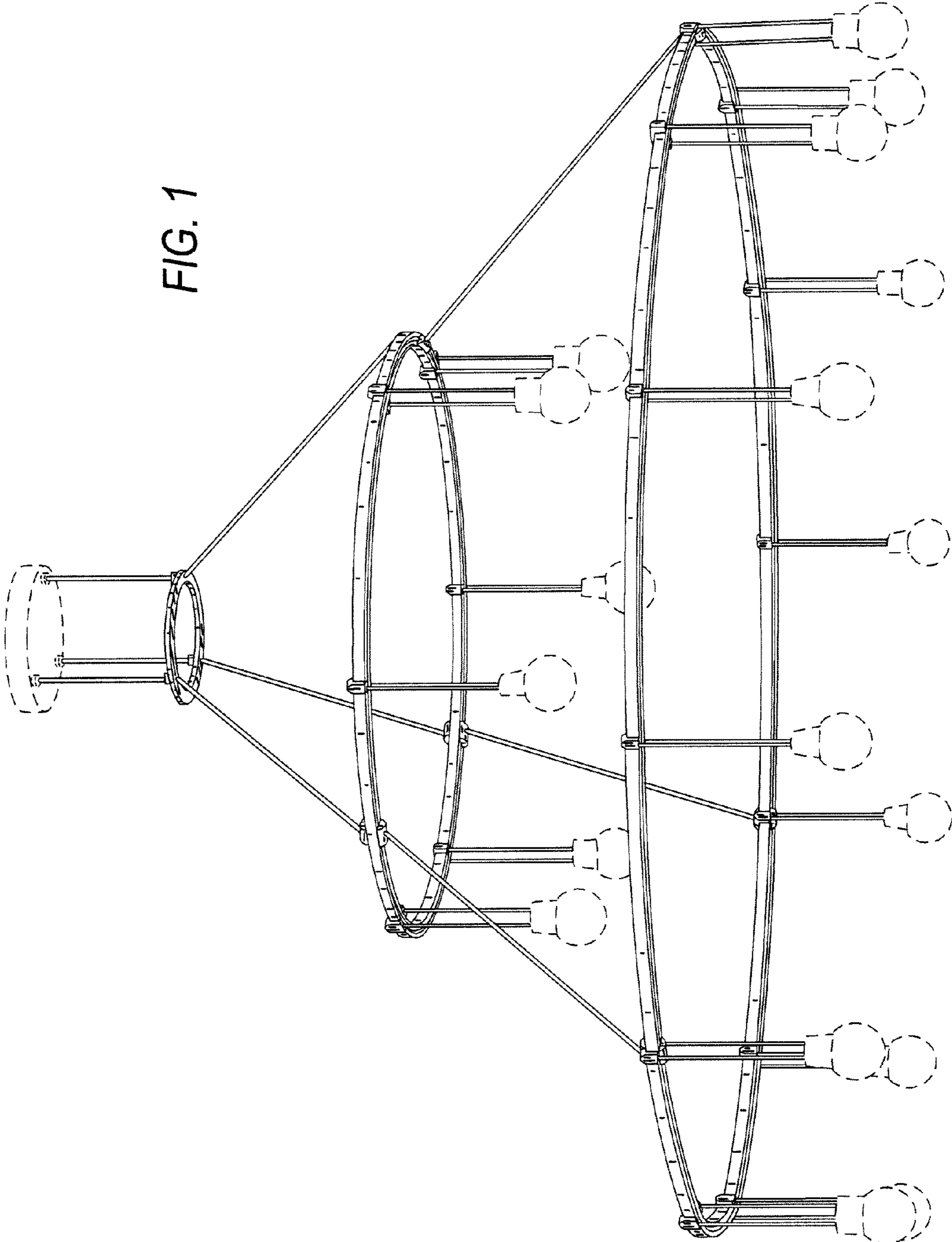

FIG. 1



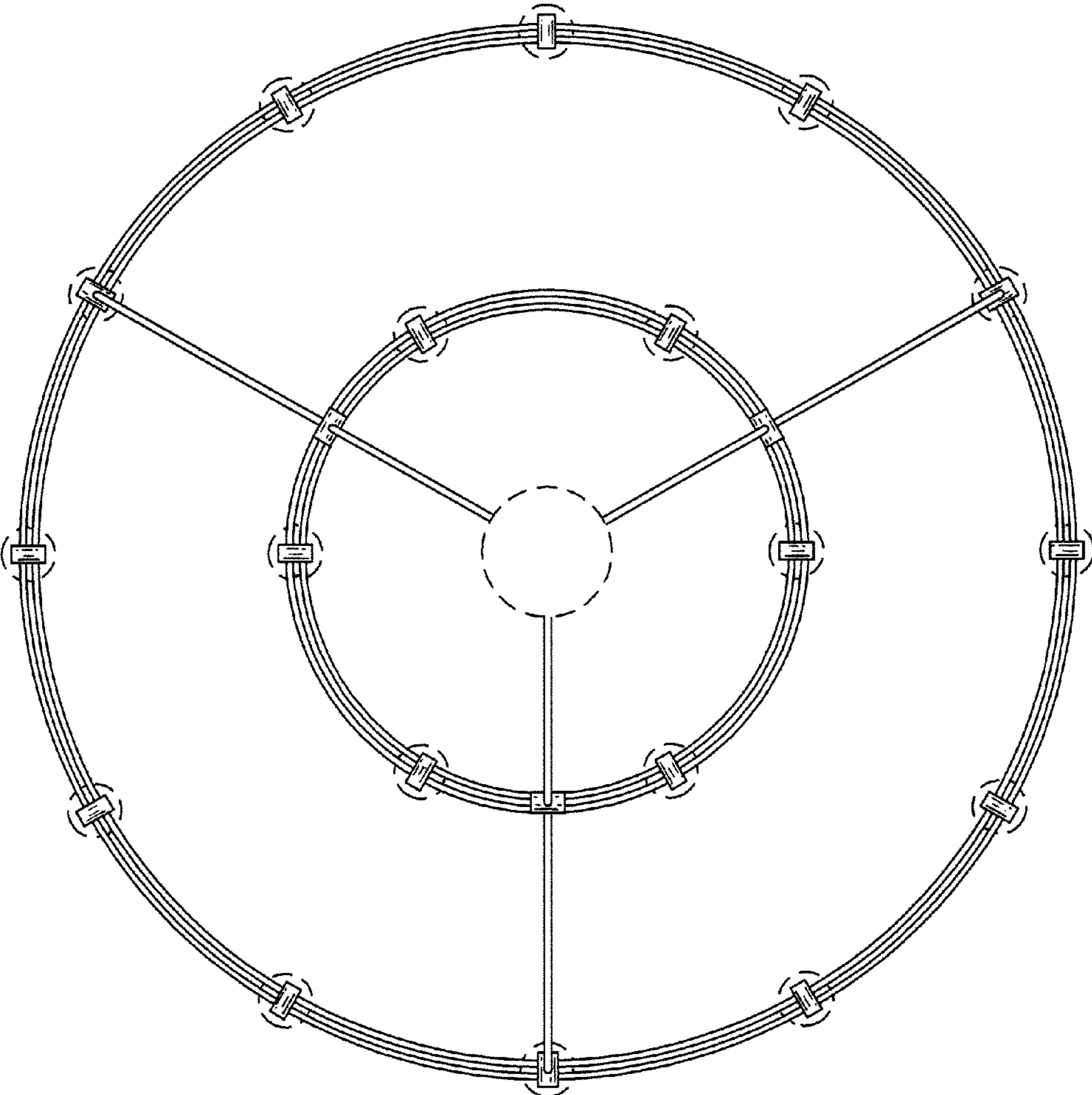

FIG. 2

FIG. 3

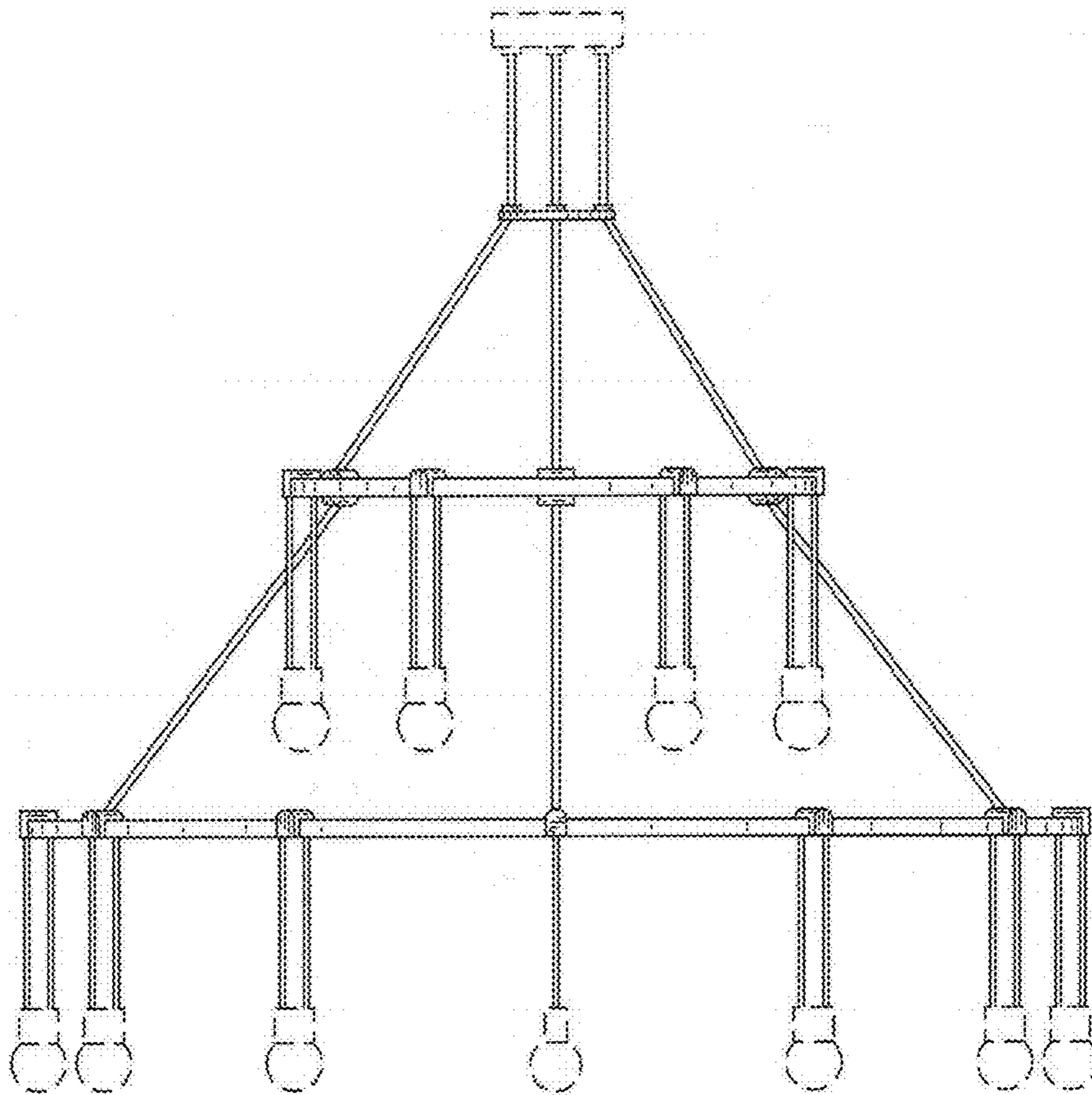
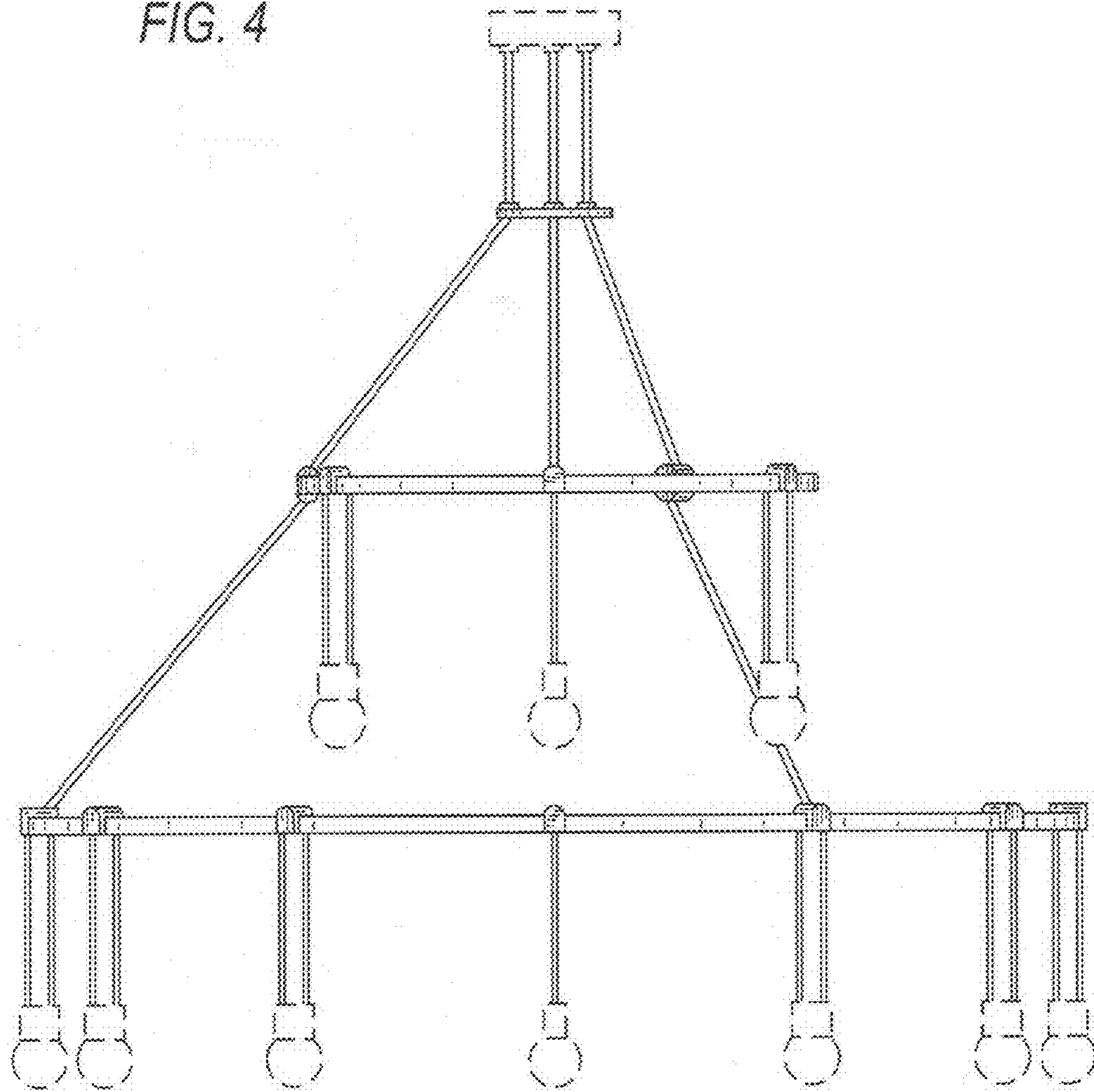

FIG. 4



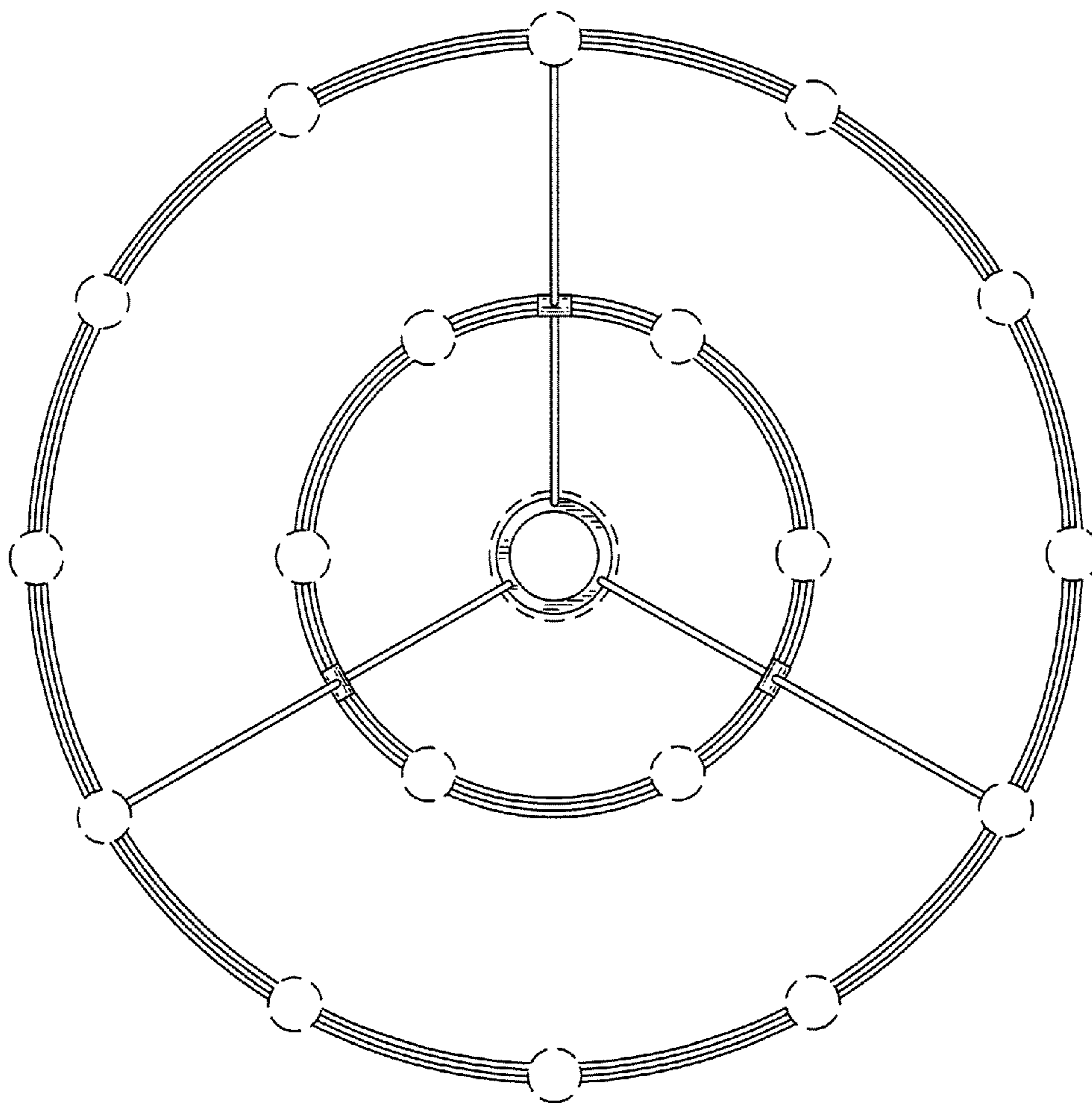

FIG. 5