



US00D773538S

(12) **United States Design Patent**
Jeon et al.

(10) **Patent No.:** **US D773,538 S**
(45) **Date of Patent:** **** Dec. 6, 2016**

(54) **REFRIGERATOR**

(71) Applicant: **Samsung Electronics Co., Ltd.**,
Suwon-si (KR)

(72) Inventors: **Sangwoon Jeon**, Seoul (KR); **Dajeong Kim**, Seoul (KR); **Selim Yoon**, Goyang-si (KR); **Hyunil Lee**, Seoul (KR); **Junhyeok Choi**, Ulsan (KR)

(73) Assignee: **SAMSUNG ELECTRONICS CO., LTD.** (KR)

(**) Term: **15 Years**

(21) Appl. No.: **29/538,388**

(22) Filed: **Sep. 3, 2015**

(30) **Foreign Application Priority Data**

Mar. 26, 2015 (KR) 30-2015-0015421

(51) **LOC (10) Cl.** **15-07**

(52) **U.S. Cl.**
USPC **D15/86**

(58) **Field of Classification Search**

USPC D15/79-91
CPC F25D 23/028; F25D 23/02; F25D 25/025;
F25D 23/00; F25D 2323/021; F25D
11/00; F25D 2323/024; F25D
23/04; F25D 29/00; F25D 25/02; F25D
25/024; F25D 27/005; F25D 23/12; F25D
29/005; F25D 17/042; F25D 2325/021;
F25D 2323/02

See application file for complete search history.

(56) **References Cited**

U.S. PATENT DOCUMENTS

D658,213 S * 4/2012 Seo D15/86
D674,823 S * 1/2013 Jidam D15/86

D676,467 S * 2/2013 Kim D15/86
D703,244 S * 4/2014 Seo D15/86
D714,367 S * 9/2014 Jeon D15/89
D727,375 S * 4/2015 You D15/86
D742,432 S * 11/2015 Jeon D15/86
D742,433 S * 11/2015 Jeon D15/86
D742,438 S * 11/2015 Jeon D15/91

FOREIGN PATENT DOCUMENTS

KR 3020060033499 8/2006
KR 3020120006183 2/2012
KR 3020120046370 9/2012
KR 3020120061391 12/2012
KR 3020140008024 2/2014

* cited by examiner

Primary Examiner — Ian Simmons

Assistant Examiner — Khawaja Anwar

(74) *Attorney, Agent, or Firm* — Cantor Colburn LLP

(57) **CLAIM**

The ornamental design for a refrigerator, as shown and described.

DESCRIPTION

FIG. 1 is a perspective view of a refrigerator, showing our new design;

FIG. 2 is a front view thereof;

FIG. 3 is a rear view thereof;

FIG. 4 is a side view thereof;

FIG. 5 is another side view thereof;

FIG. 6 is a top view thereof;

FIG. 7 is a bottom view thereof; and,

FIG. 8 is an enlarged view of the encircled portion 8 of FIG. 1.

The broken lines illustrating portions of the refrigerator form no part of the claimed design.

The dot-dash broken lines encircling enlargement portions of the design form no part of the claimed design.

1 Claim, 8 Drawing Sheets

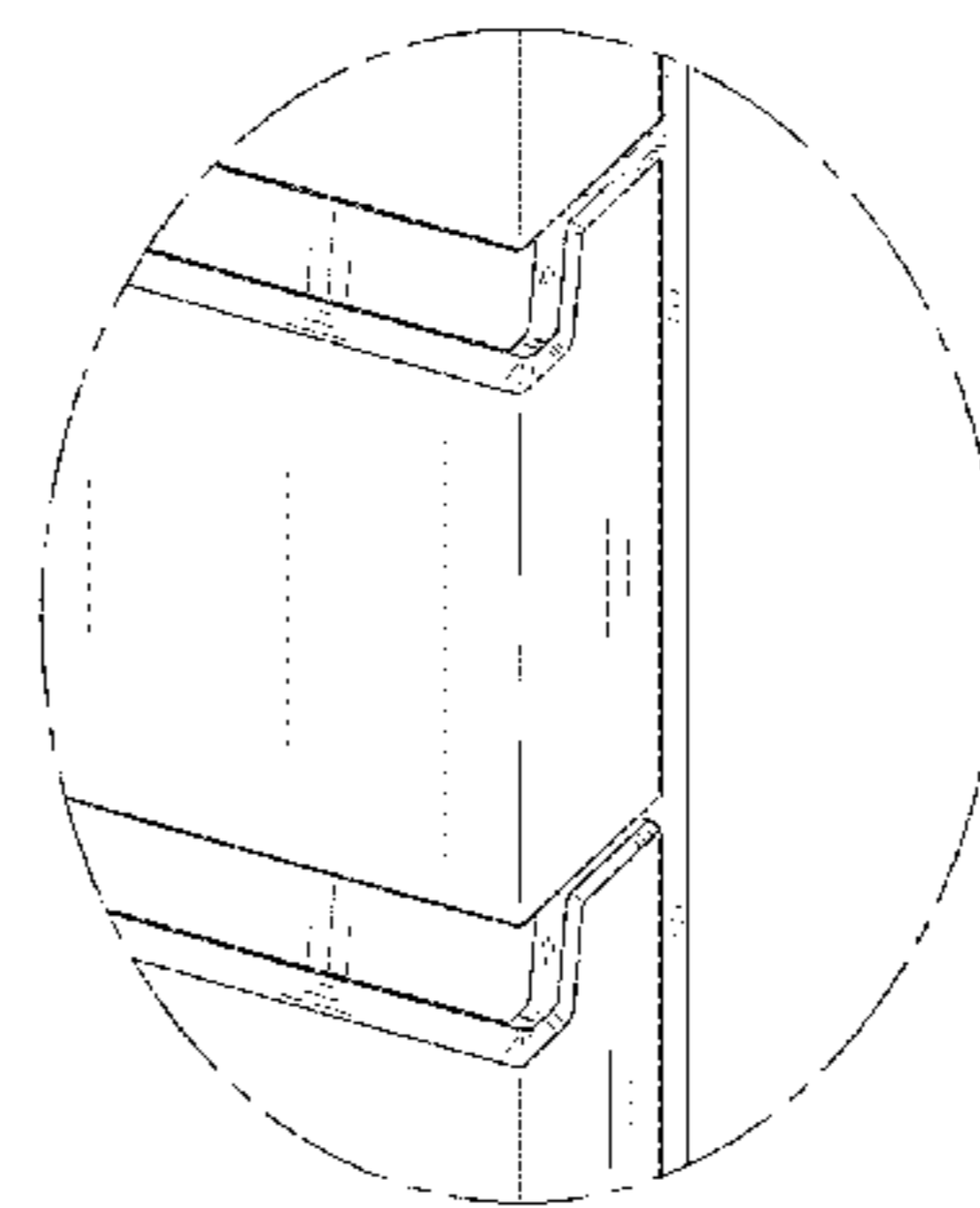
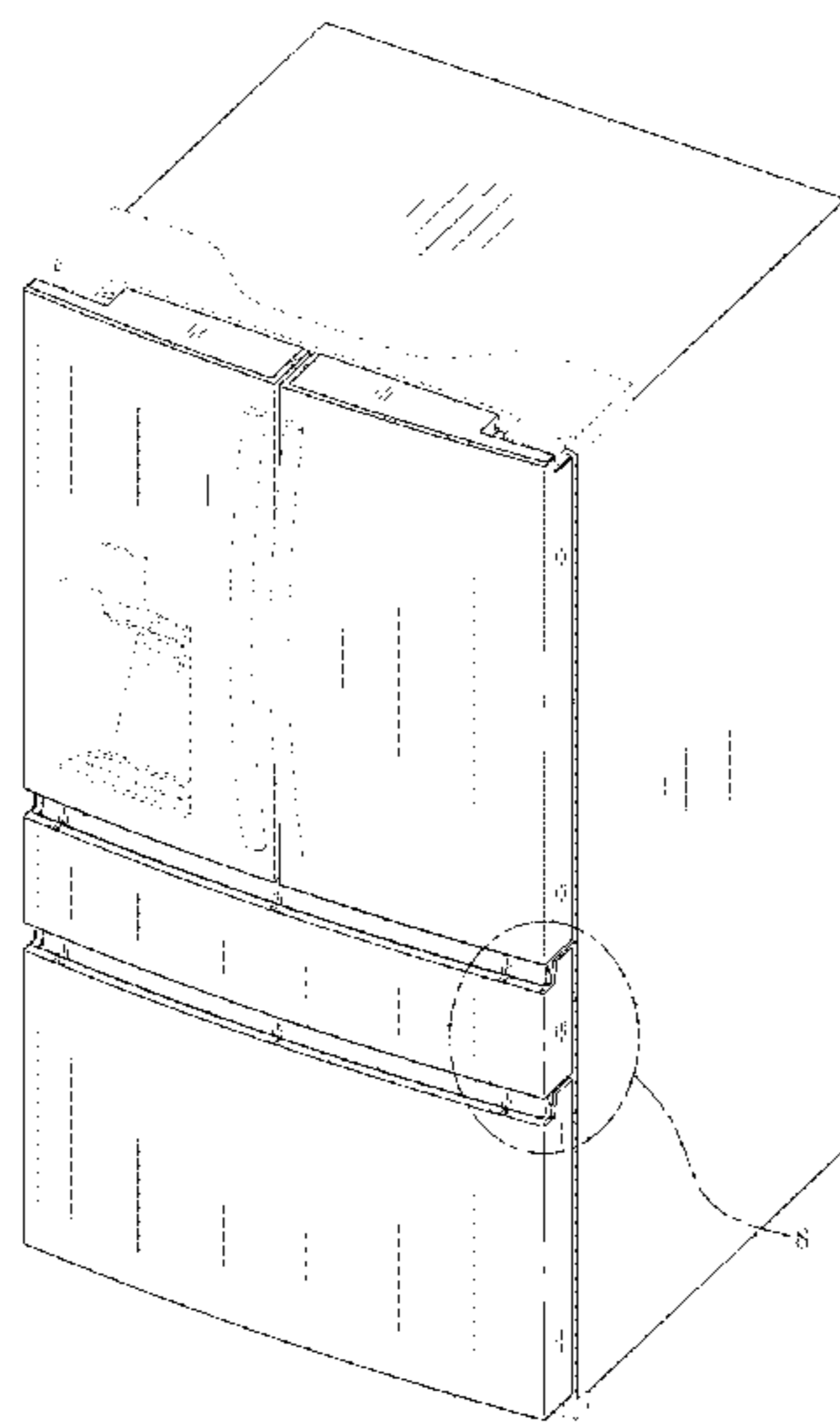

FIG. 1

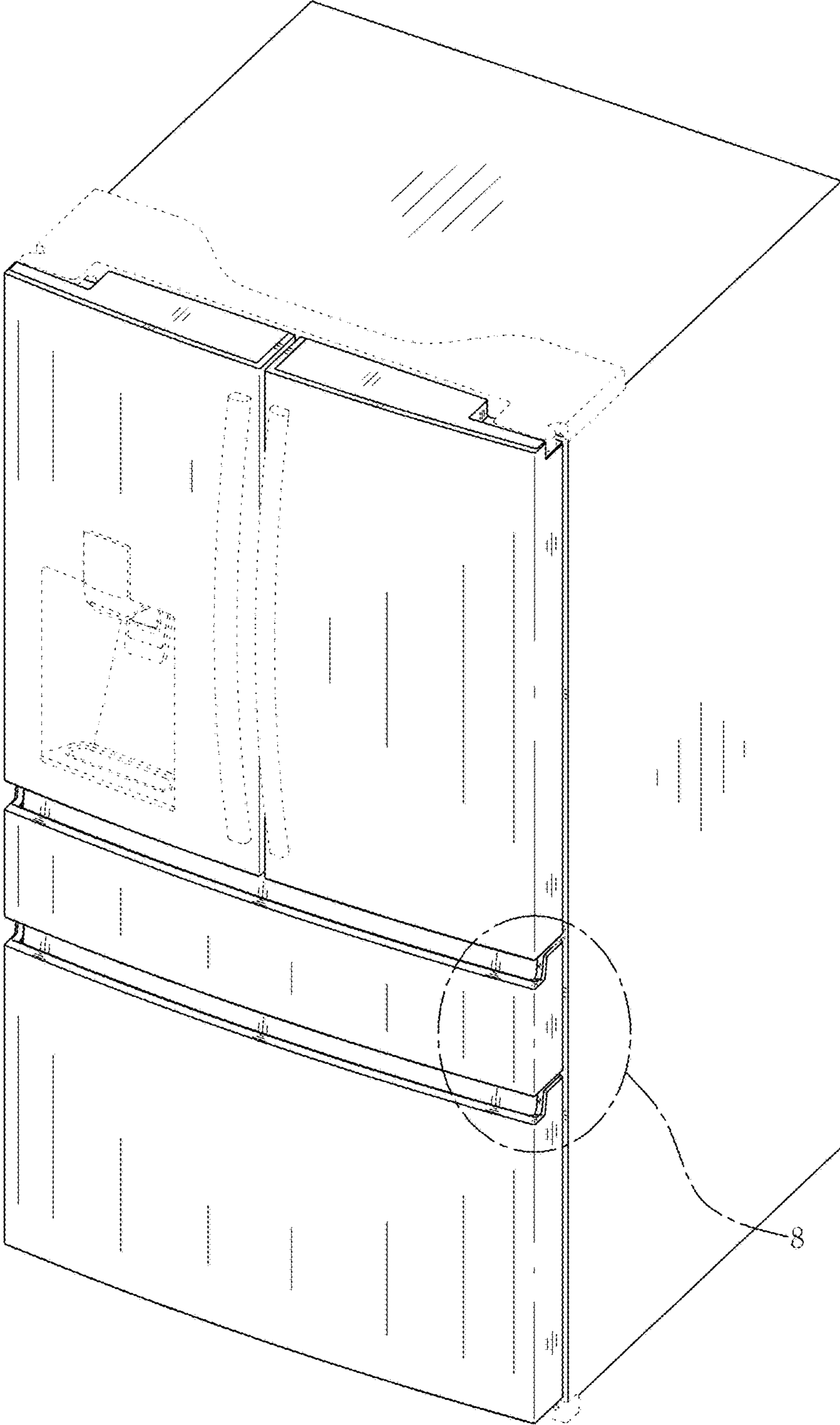

FIG. 2

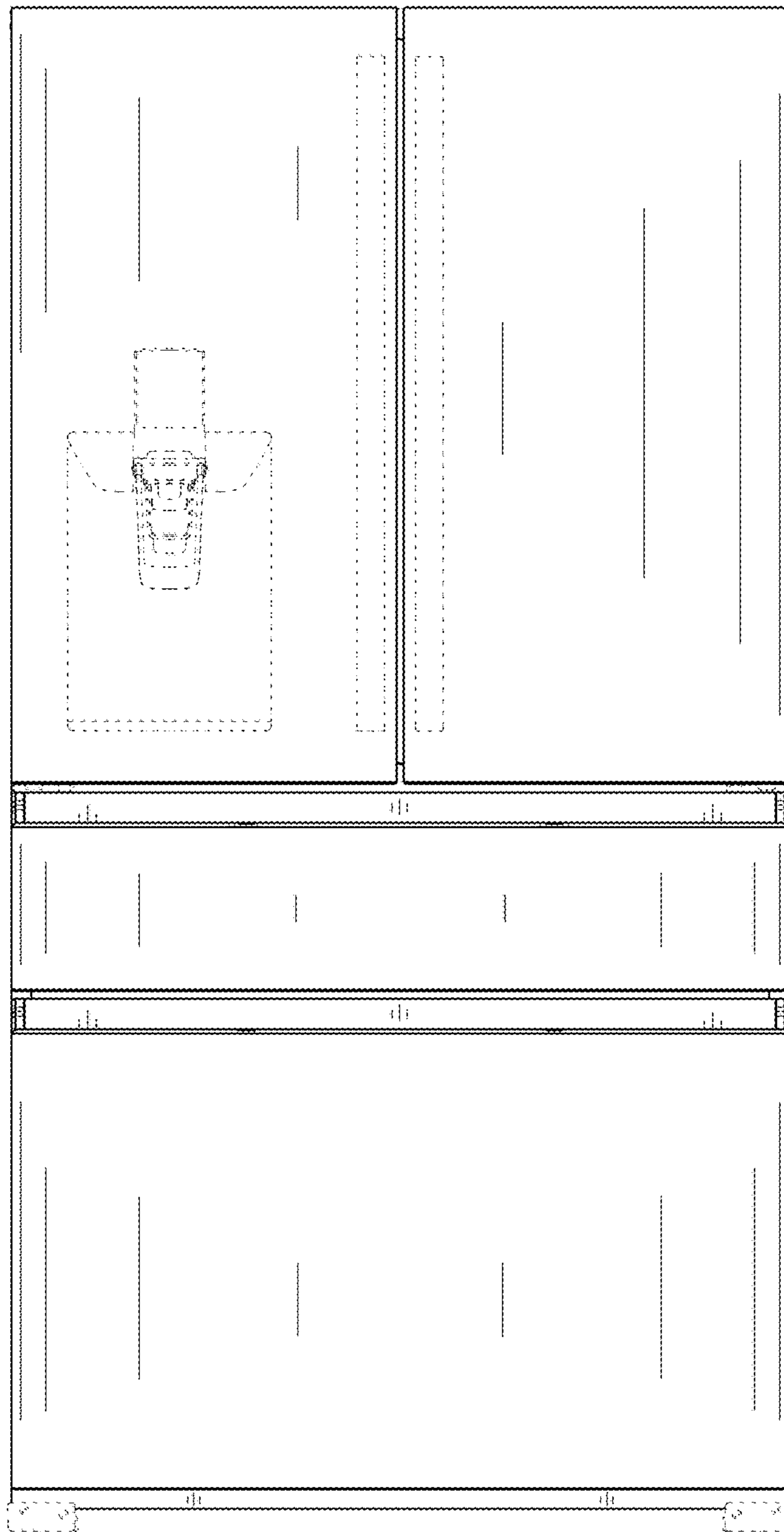

FIG. 3

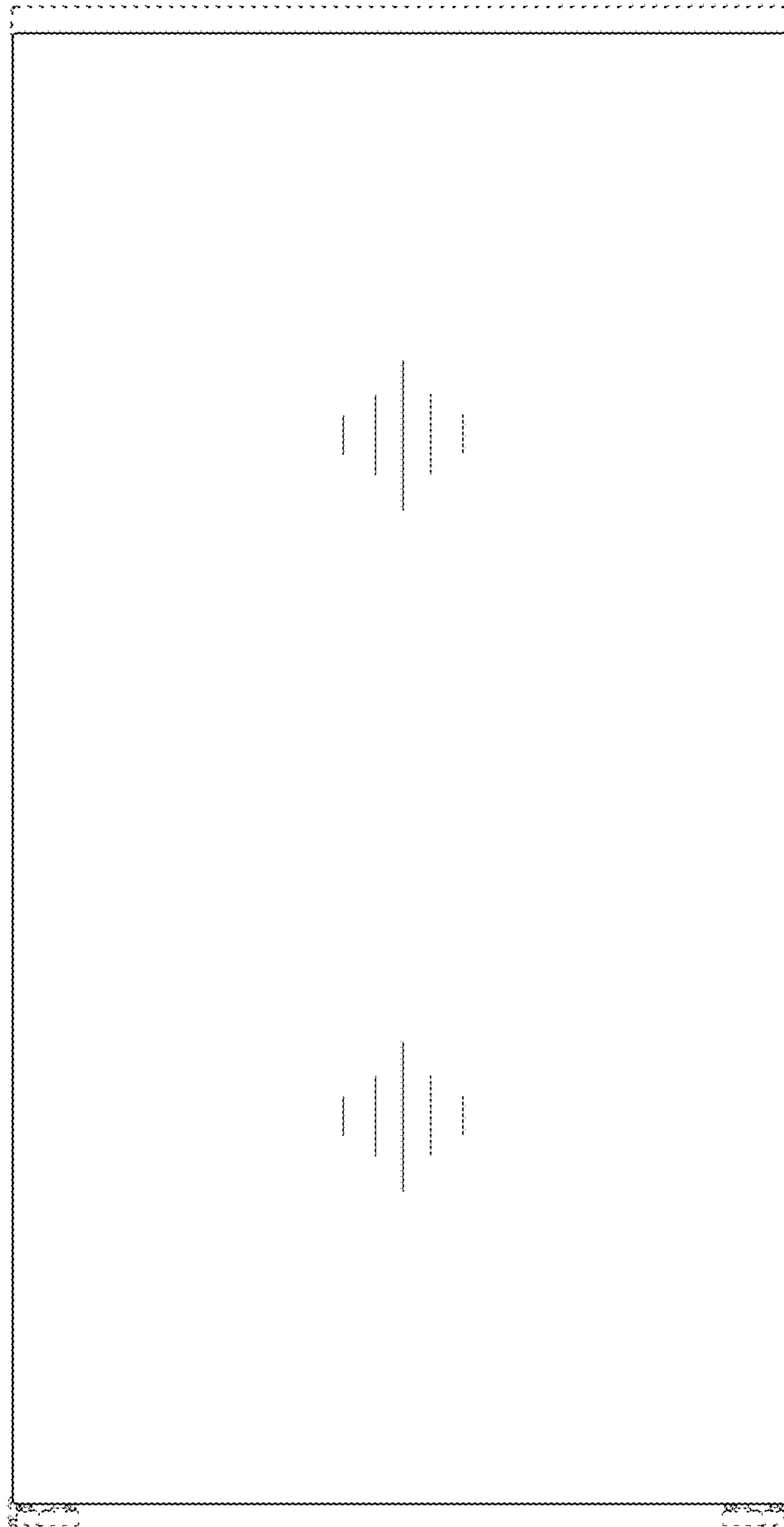

FIG. 4

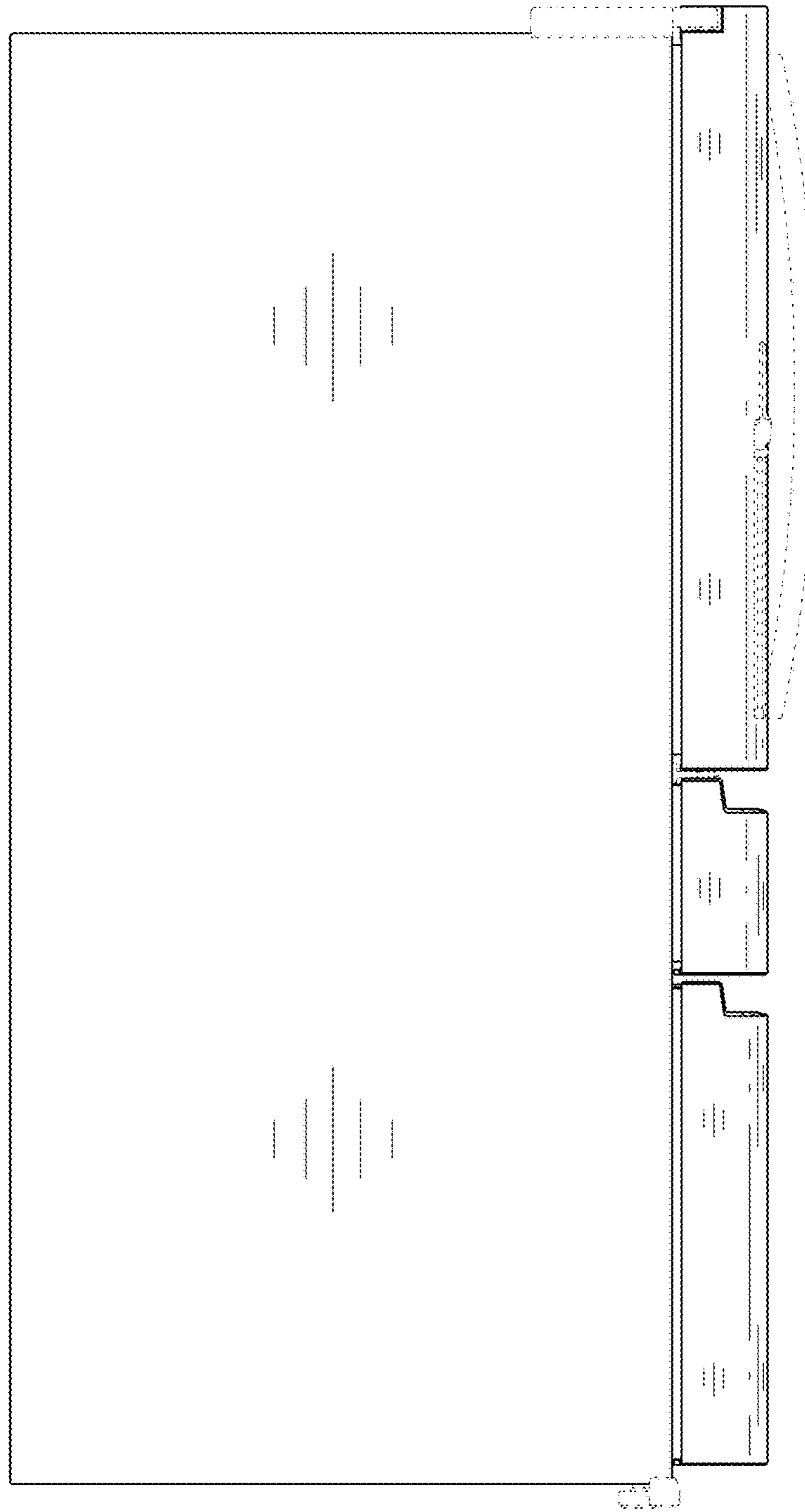

FIG. 5

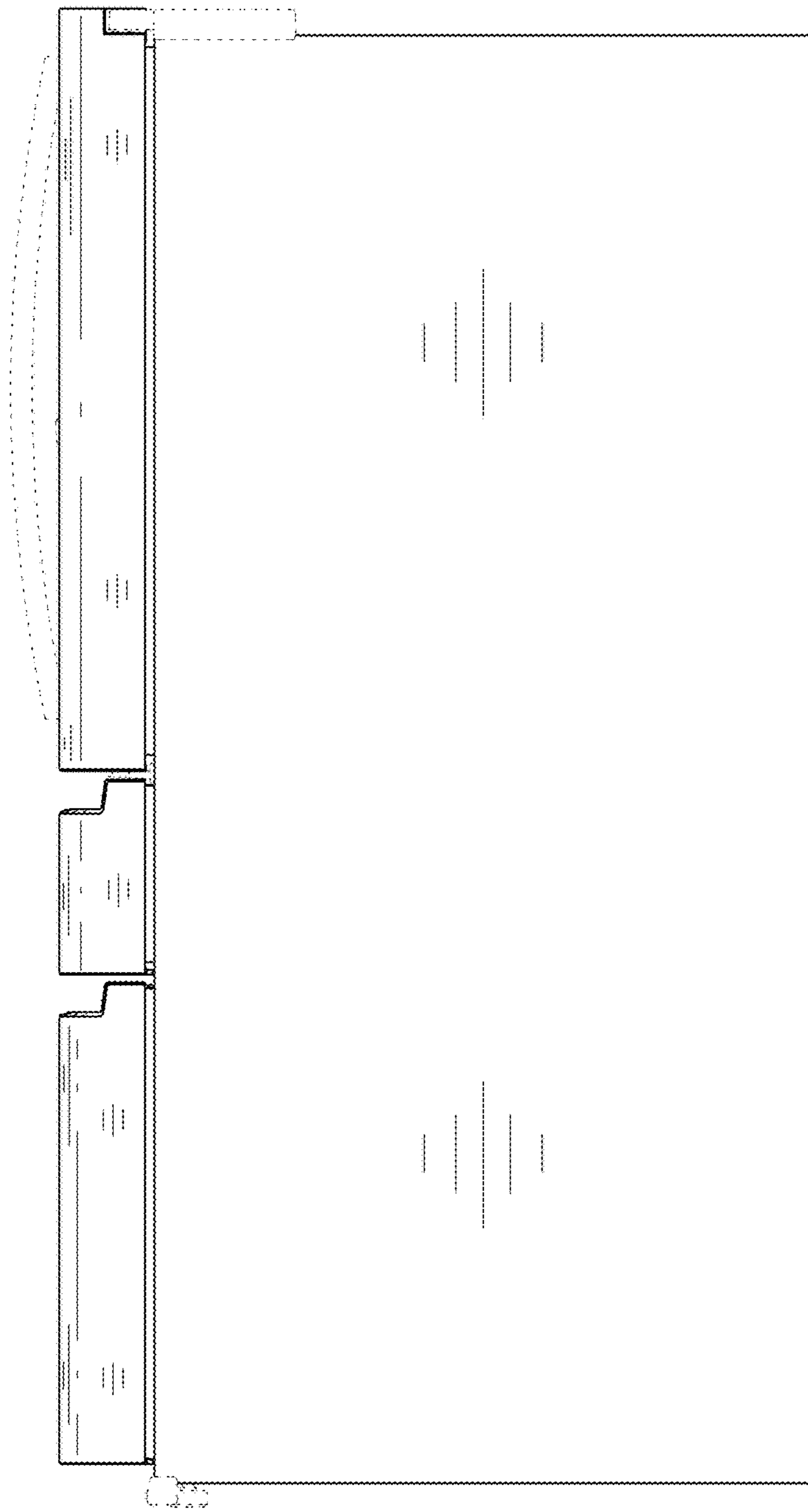

FIG. 6

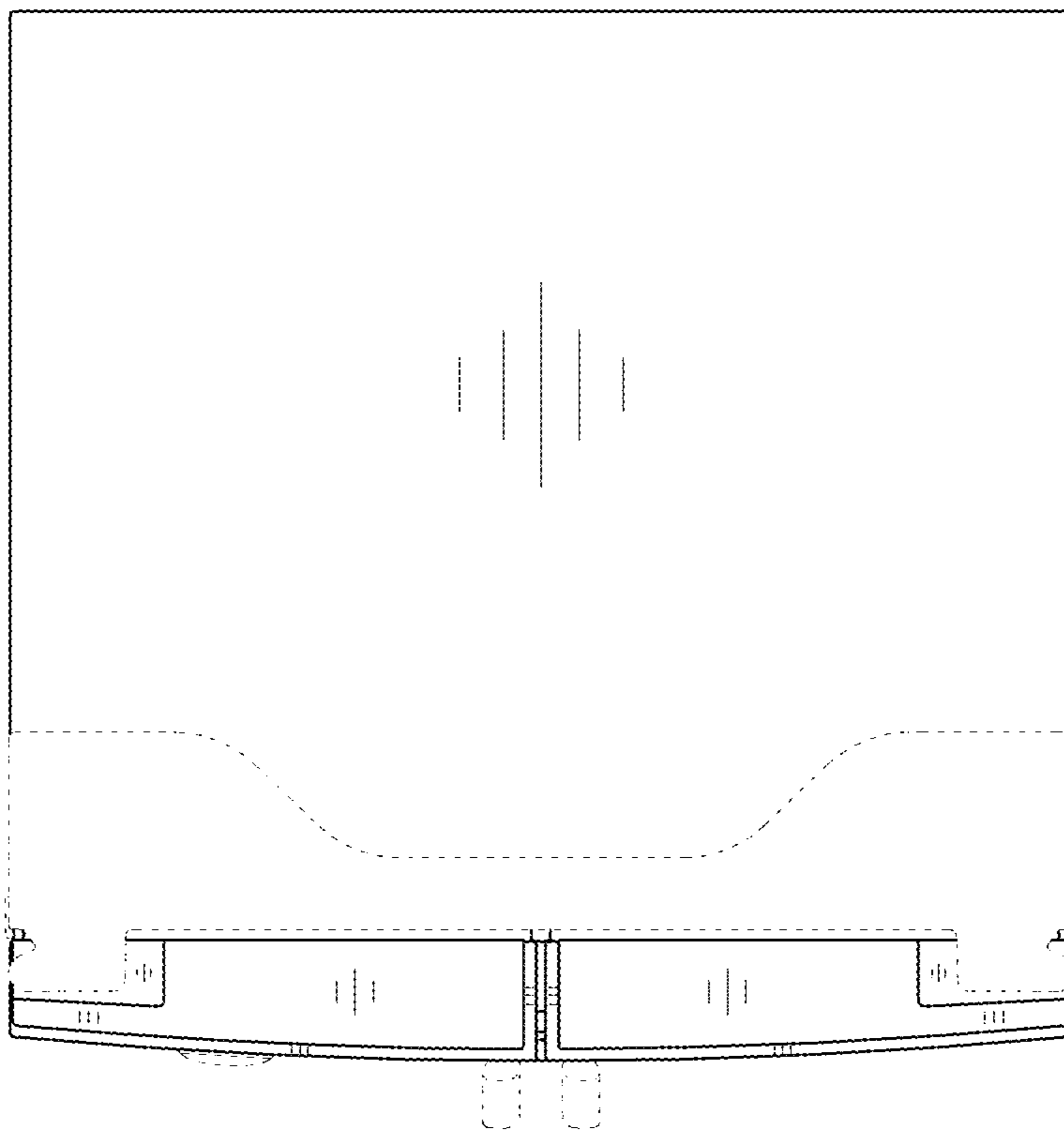

FIG. 7

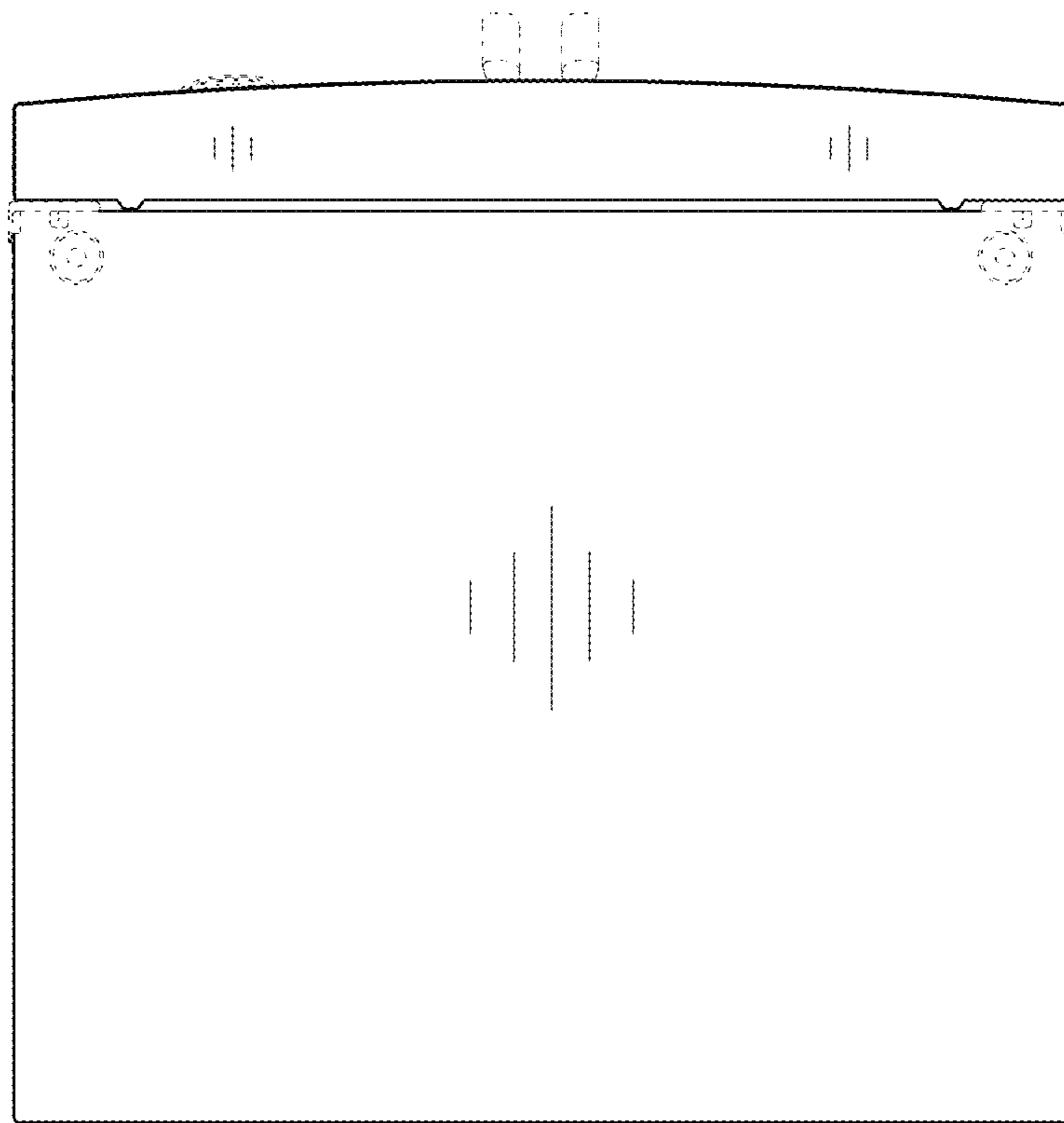

FIG. 8

