



US00D773439S

(12) **United States Design Patent**  
**Walker**

(10) **Patent No.:** **US D773,439 S**

(45) **Date of Patent:** **\*\* Dec. 6, 2016**

(54) **EAR BUD ADAPTER**

(71) Applicant: **Harman International Industries, Incorporated**, Northridge, CA (US)

(72) Inventor: **Jason Walker**, St. Louis, MO (US)

(73) Assignee: **Harman International Industries, Incorporated**, Northridge, CA (US)

(\*\*) Term: **15 Years**

(21) Appl. No.: **29/535,268**

(22) Filed: **Aug. 5, 2015**

(51) **LOC (10) Cl.** ..... **14-01**

(52) **U.S. Cl.**

USPC ..... **D14/223**; D14/205

(58) **Field of Classification Search**

USPC ..... D14/223, 205; D24/174, 182; 181/129, 181/130, 135; 379/430, 431; 381/380, 381,

381/322, 328; 455/90.1, 575.1

CPC ..... H04R 25/00; H04R 1/10; H04R 1/1016

See application file for complete search history.

(56) **References Cited**

**U.S. PATENT DOCUMENTS**

|           |     |         |            |       |             |
|-----------|-----|---------|------------|-------|-------------|
| 333,724   | A * | 1/1886  | Blodgett   | ..... | H04R 25/652 |
|           |     |         |            |       | 181/130     |
| 2,513,985 | A * | 7/1950  | Woodruff   | ..... | H04R 1/1008 |
|           |     |         |            |       | 181/130     |
| 2,719,523 | A * | 10/1955 | Von Gierke | ..... | A61F 11/10  |
|           |     |         |            |       | 128/864     |
| 2,939,923 | A * | 6/1960  | Henderson  | ..... | H04R 1/1016 |
|           |     |         |            |       | 381/328     |
| 3,047,089 | A * | 7/1962  | Zwislocki  | ..... | A61F 11/08  |
|           |     |         |            |       | 128/864     |
| 3,104,290 | A * | 9/1963  | Rosemond   | ..... | G02C 11/06  |
|           |     |         |            |       | 351/158     |
| 3,368,644 | A * | 2/1968  | Henderson  | ..... | G02C 11/06  |
|           |     |         |            |       | 181/129     |
| 3,496,306 | A * | 2/1970  | Pollak     | ..... | H04R 25/608 |
|           |     |         |            |       | 29/896.21   |
| 4,055,233 | A * | 10/1977 | Huntress   | ..... | A61B 7/02   |
|           |     |         |            |       | 128/864     |
| 4,069,400 | A * | 1/1978  | Johanson   | ..... | H04R 25/60  |
|           |     |         |            |       | 381/322     |
| 4,349,083 | A * | 9/1982  | Bennett    | ..... | H04R 25/48  |
|           |     |         |            |       | 181/130     |

|           |     |         |           |       |             |
|-----------|-----|---------|-----------|-------|-------------|
| D266,590  | S * | 10/1982 | Bennett   | ..... | D24/174     |
| 4,375,016 | A * | 2/1983  | Harada    | ..... | H04R 25/656 |
|           |     |         |           |       | 181/135     |
| D270,566  | S * | 9/1983  | Bennett   | ..... | D24/174     |
| D287,280  | S * | 12/1986 | Topholm   | ..... | D24/174     |
| D287,764  | S * | 1/1987  | Topholm   | ..... | D24/174     |
| D287,765  | S * | 1/1987  | Topholm   | ..... | D24/174     |
| 4,652,414 | A * | 3/1987  | Schlaegel | ..... | H04R 25/652 |
|           |     |         |           |       | 181/129     |
| D340,286  | S * | 10/1993 | Seo       | ..... | D24/174     |
| 5,345,509 | A * | 9/1994  | Hofer     | ..... | H04R 25/652 |
|           |     |         |           |       | 381/151     |
| D368,309  | S * | 3/1996  | Narisawa  | ..... | D24/106     |
| D399,001  | S * | 9/1998  | Yabe      | ..... | D24/174     |

(Continued)

*Primary Examiner* — Paula Greene

(74) *Attorney, Agent, or Firm* — Plumsea Law Group, LLC

(57) **CLAIM**

The ornamental design for an ear bud adapter, as shown and described.

**DESCRIPTION**

FIG. 1 is a perspective view of a right-handed embodiment of an ear bud adapter showing our new design;

FIG. 2 is a side elevational view of one side thereof;

FIG. 3 is a side elevational view of the opposite side thereof;

FIG. 4 is a front elevational view thereof;

FIG. 5 is a rear elevational view thereof;

FIG. 6 is a top plan view thereof;

FIG. 7 is a bottom plan view thereof;

FIG. 8 is a perspective view of a left-handed embodiment of the ear bud adapter showing our new design;

FIG. 9 is a side elevational view of one side thereof;

FIG. 10 is a side elevational view of the opposite side thereof;

FIG. 11 is a front elevational view thereof;

FIG. 12 is a rear elevational view thereof;

FIG. 13 is a top plan view thereof; and,

FIG. 14 is a bottom plan view thereof.

The broken line showings form no part of the claimed design.

**1 Claim, 8 Drawing Sheets**

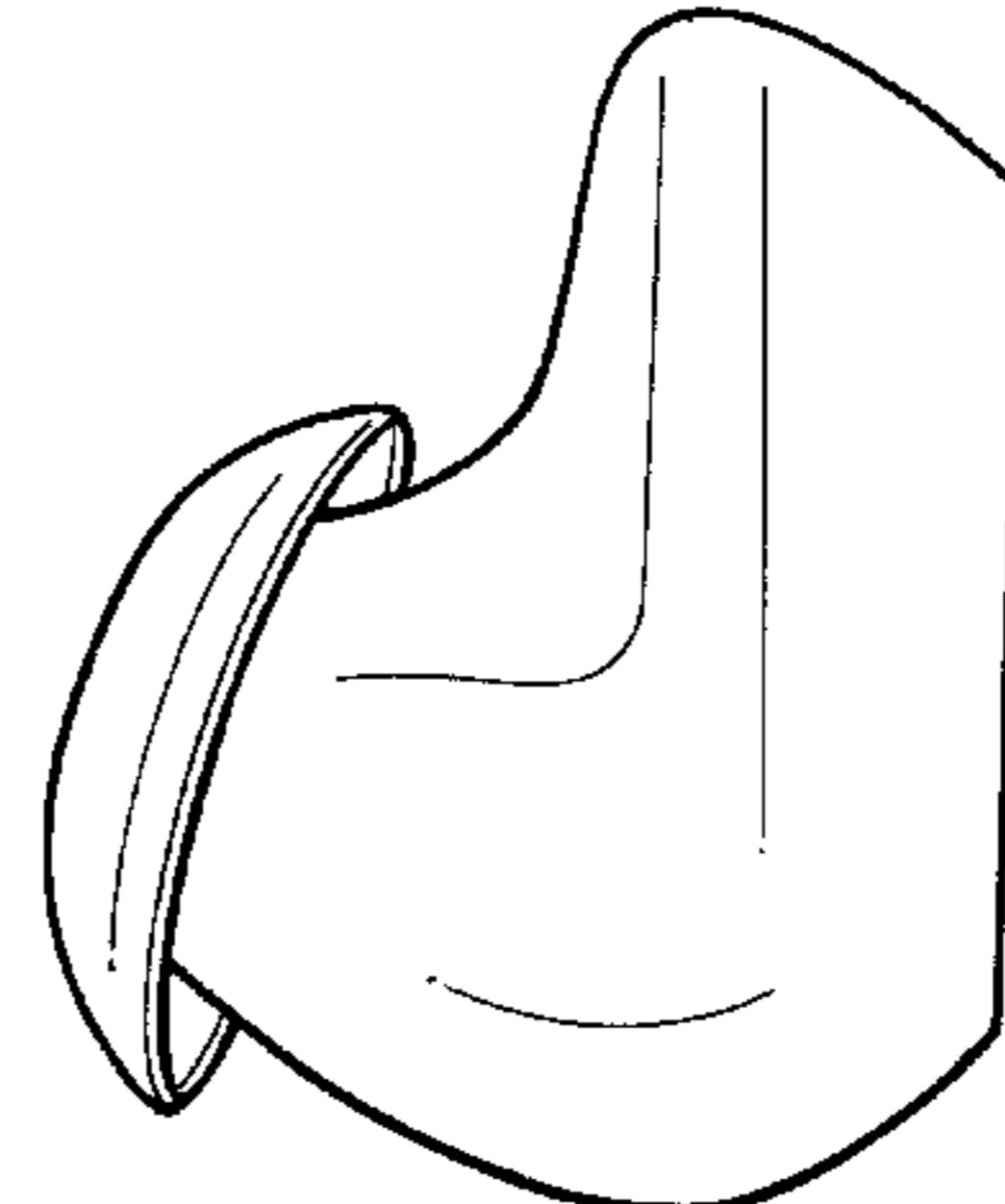
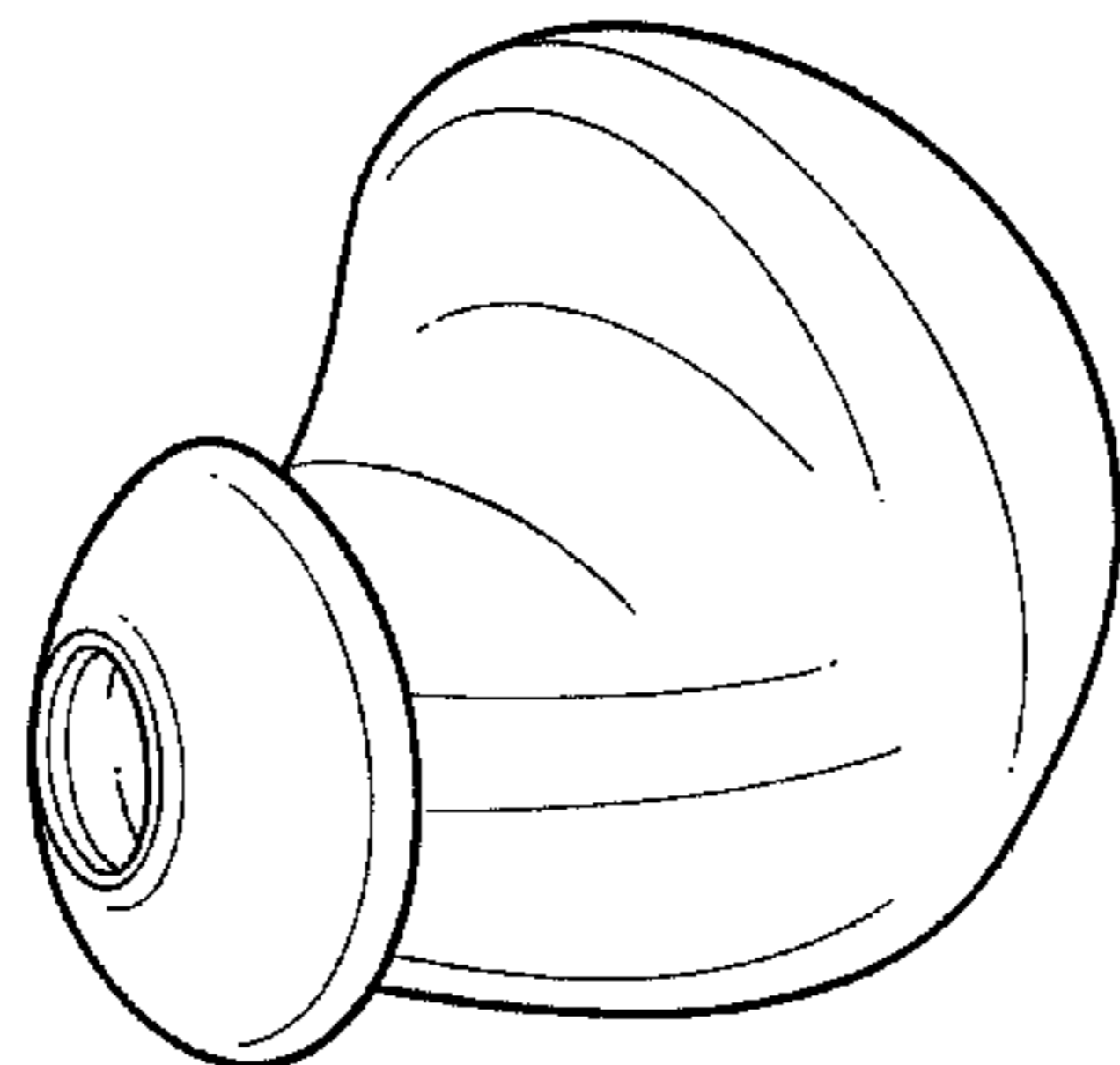

(56)

References Cited

U.S. PATENT DOCUMENTS

|              |      |         |           |       |                        |
|--------------|------|---------|-----------|-------|------------------------|
| 6,122,388    | A *  | 9/2000  | Feldman   | ..... | H04R 25/604<br>381/322 |
| D478,991     | S *  | 8/2003  | Dyer      | ..... | D24/174                |
| 6,690,807    | B1 * | 2/2004  | Meyer     | ..... | G02C 5/143<br>2/12     |
| D505,132     | S *  | 5/2005  | Linville  | ..... | D14/223                |
| D514,094     | S *  | 1/2006  | Griffin   | ..... | D14/223                |
| 7,003,127    | B1 * | 2/2006  | Sjursen   | ..... | H04R 19/016<br>381/322 |
| 7,010,137    | B1 * | 3/2006  | Leedom    | ..... | A61B 5/6817<br>381/322 |
| 7,092,543    | B1 * | 8/2006  | Mahoney   | ..... | H04R 25/65<br>381/322  |
| 7,113,611    | B2 * | 9/2006  | Leedom    | ..... | H04R 25/608<br>381/322 |
| D532,770     | S *  | 11/2006 | Engstrom  | ..... | D14/205                |
| D535,642     | S *  | 1/2007  | Garcia    | ..... | D14/206                |
| D549,222     | S *  | 8/2007  | Huang     | ..... | D14/223                |
| D554,756     | S *  | 11/2007 | Sjursen   | ..... | D24/174                |
| D557,253     | S *  | 12/2007 | Engstrom  | ..... | D14/205                |
| D557,254     | S *  | 12/2007 | Engstrom  | ..... | D14/205                |
| D574,361     | S *  | 8/2008  | Sasaki    | ..... | D14/205                |
| D575,361     | S *  | 8/2008  | Davis     | ..... | D21/682                |
| D601,134     | S *  | 9/2009  | Elabidi   | ..... | D14/223                |
| D611,929     | S *  | 3/2010  | Blanchard | ..... | D14/205                |
| 7,965,855    | B1 * | 6/2011  | Ham       | ..... | H04R 1/1091<br>181/130 |
| D666,581     | S *  | 9/2012  | Perez     | ..... | D14/223                |
| D687,021     | S *  | 7/2013  | Yuen      | ..... | D14/223                |
| D721,354     | S *  | 1/2015  | Thompson  | ..... | D14/223                |
| D740,786     | S *  | 10/2015 | Huang     | ..... | D14/205                |
| D744,456     | S *  | 12/2015 | Pedersen  | ..... | D14/223                |
| D755,158     | S *  | 5/2016  | Lee       | ..... | D14/205                |
| D763,224     | S *  | 8/2016  | Silvestri | ..... | D14/205                |
| 2006/0050912 | A1 * | 3/2006  | Kidd      | ..... | H04R 25/656<br>381/322 |
| 2013/0188819 | A1 * | 7/2013  | Young-Mun | ..... | H04R 1/1016<br>381/380 |

\* cited by examiner

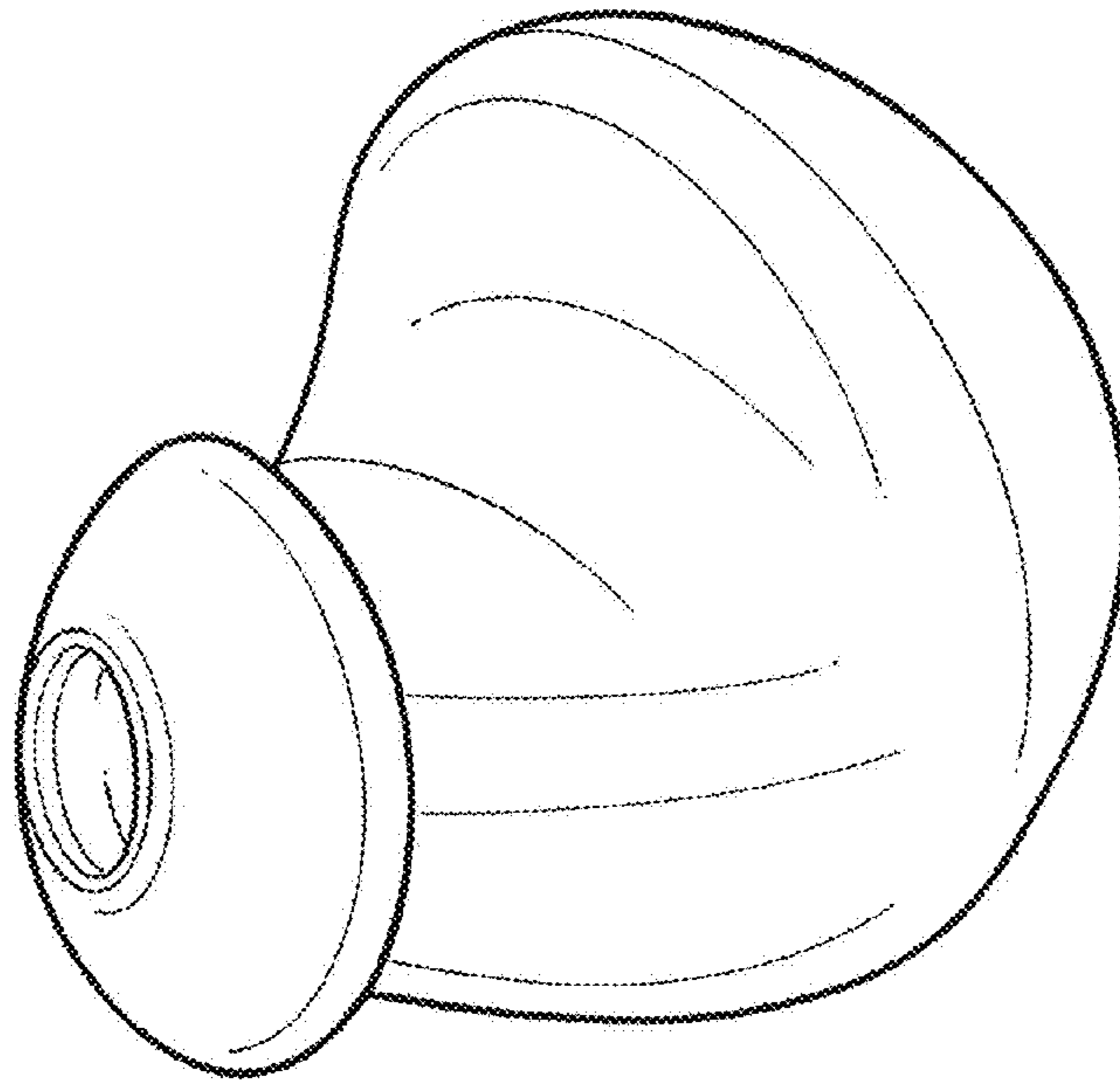

FIG. 1

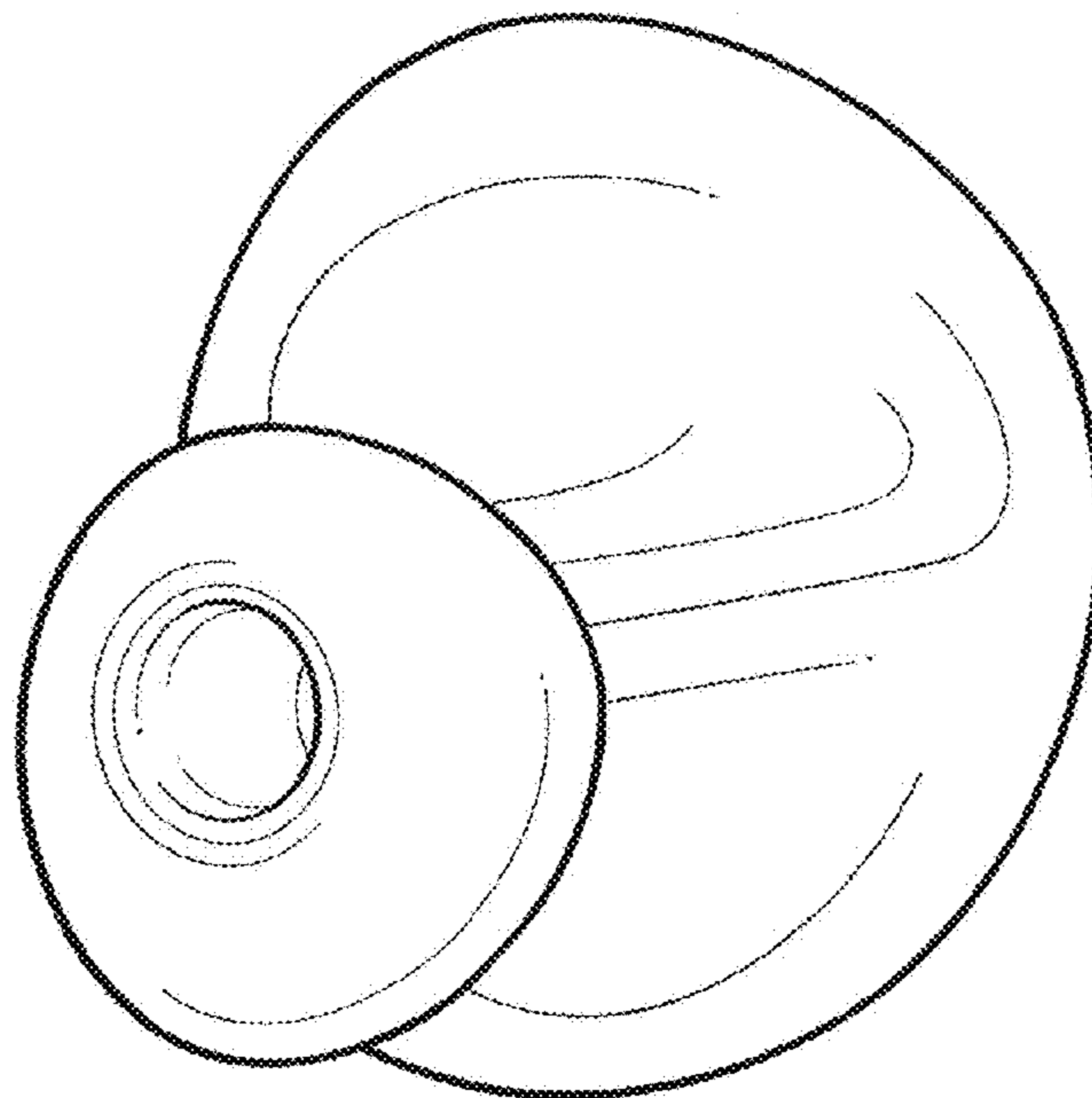

FIG. 2

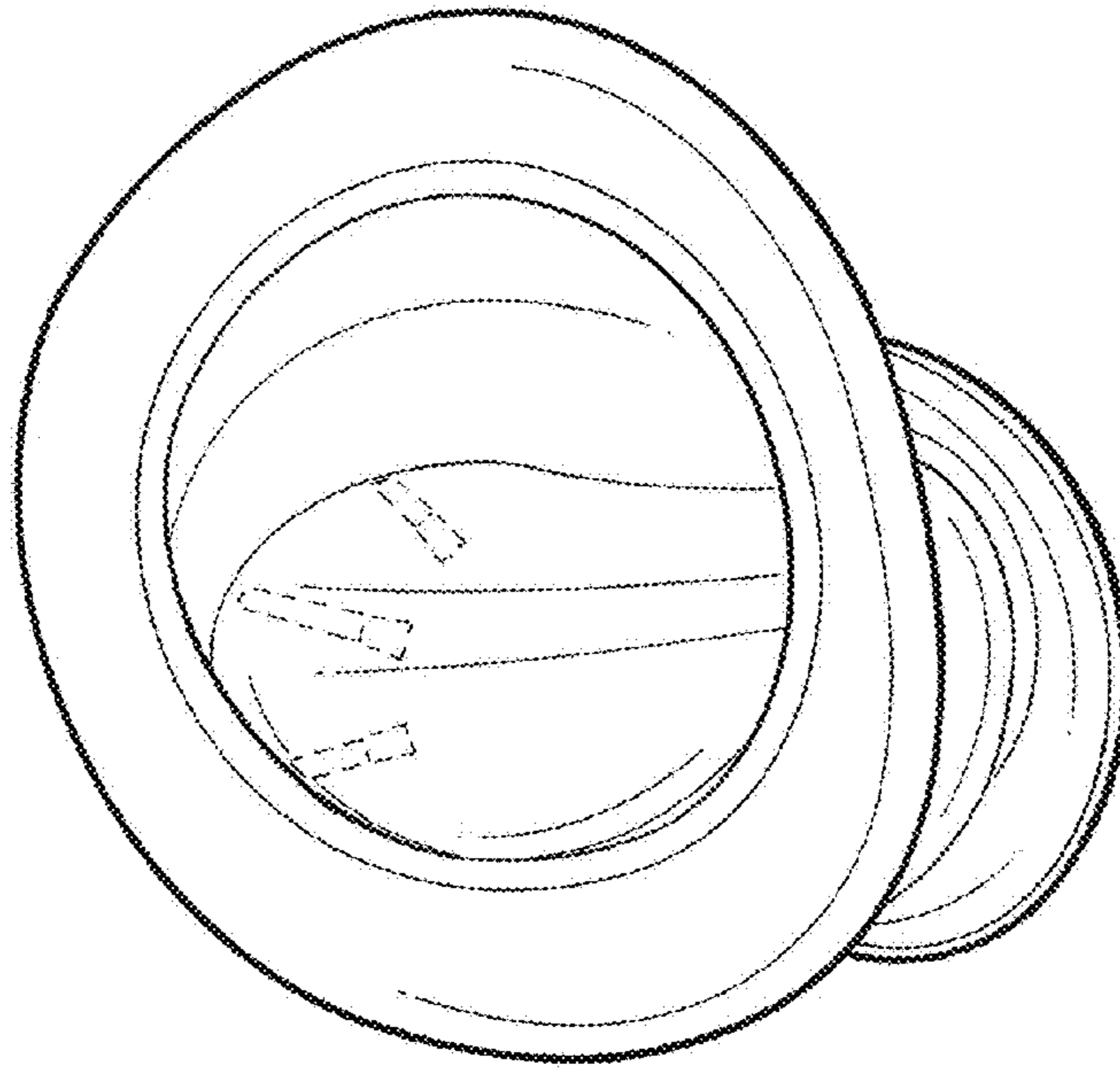

FIG. 3

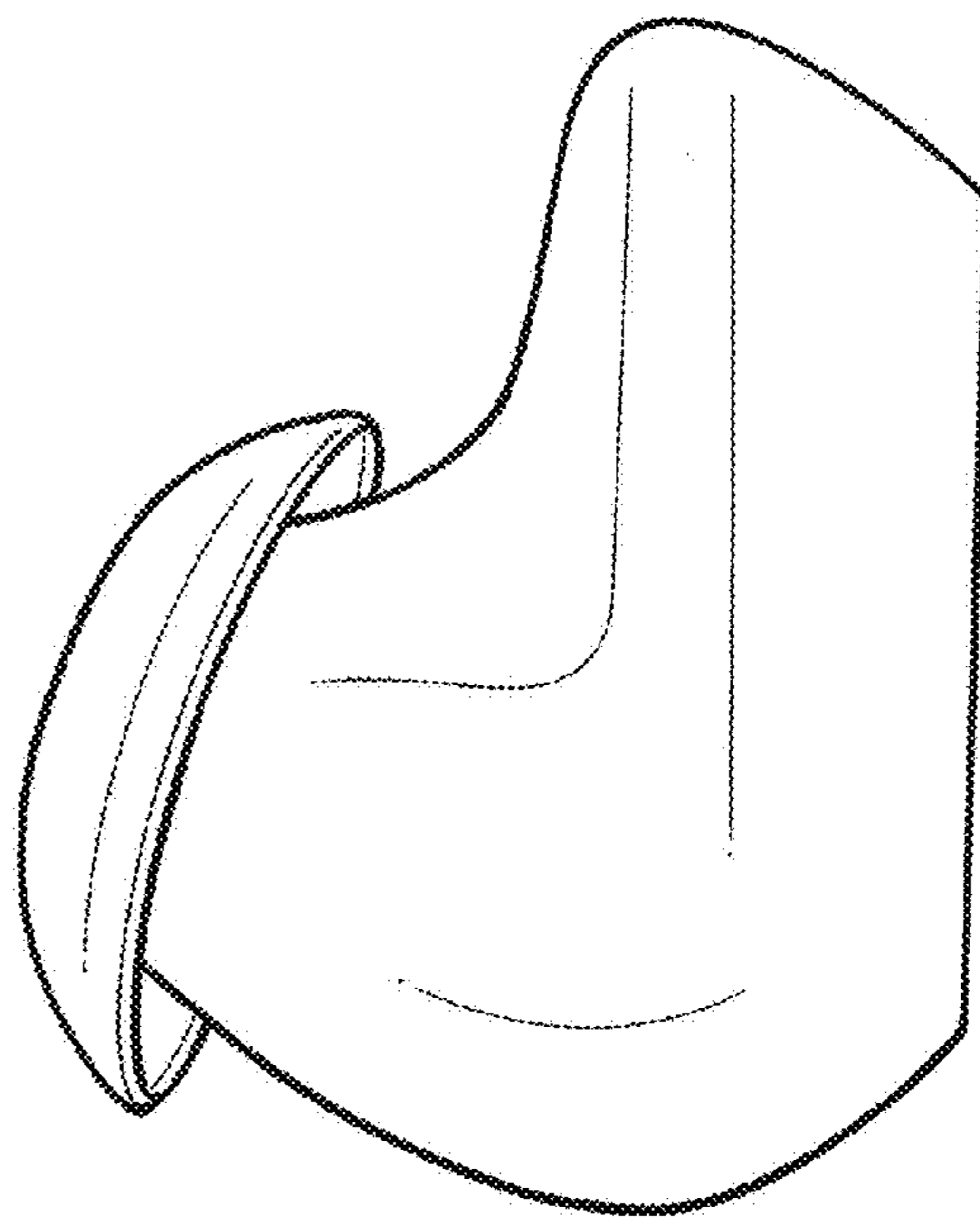

FIG. 4

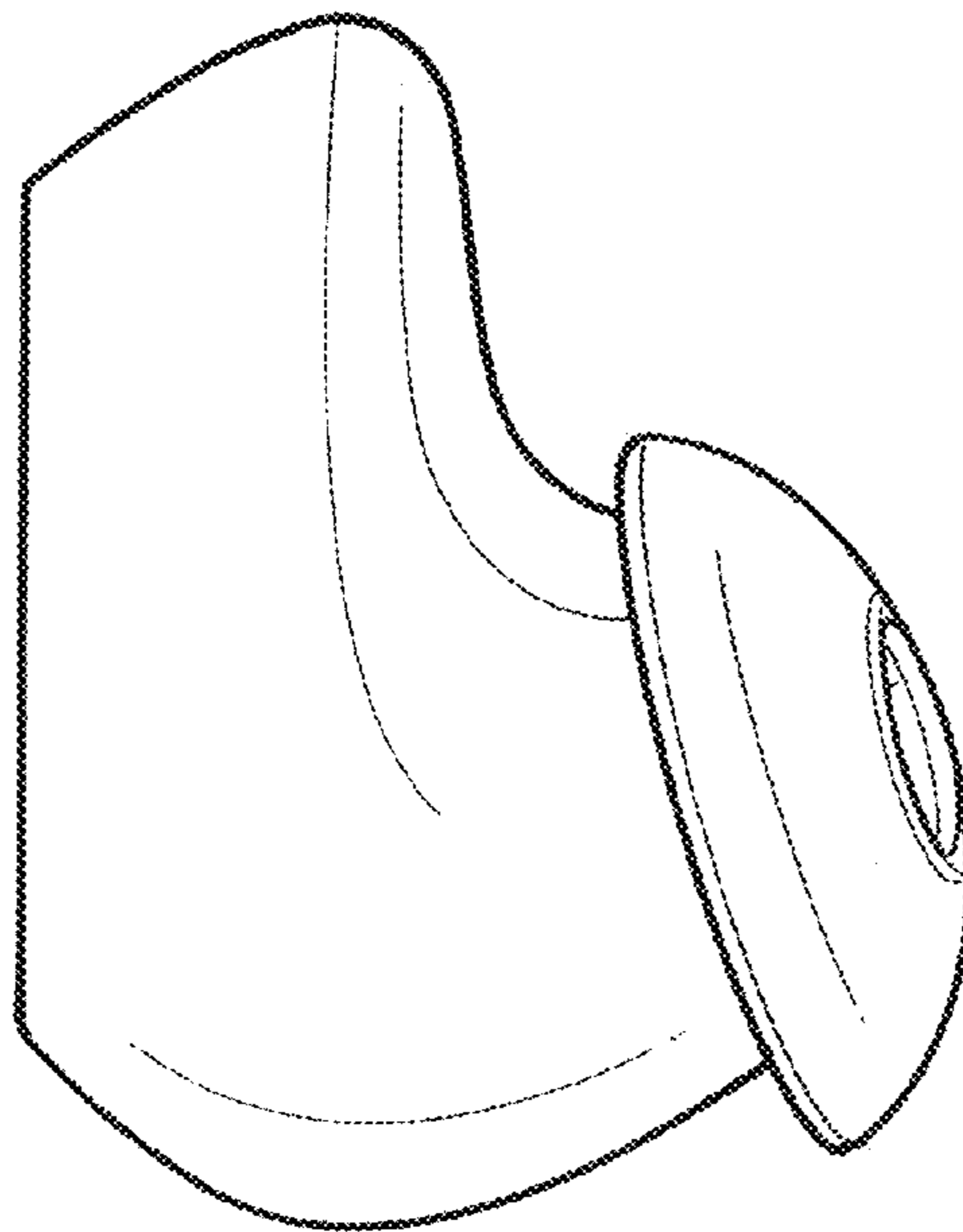

FIG. 5

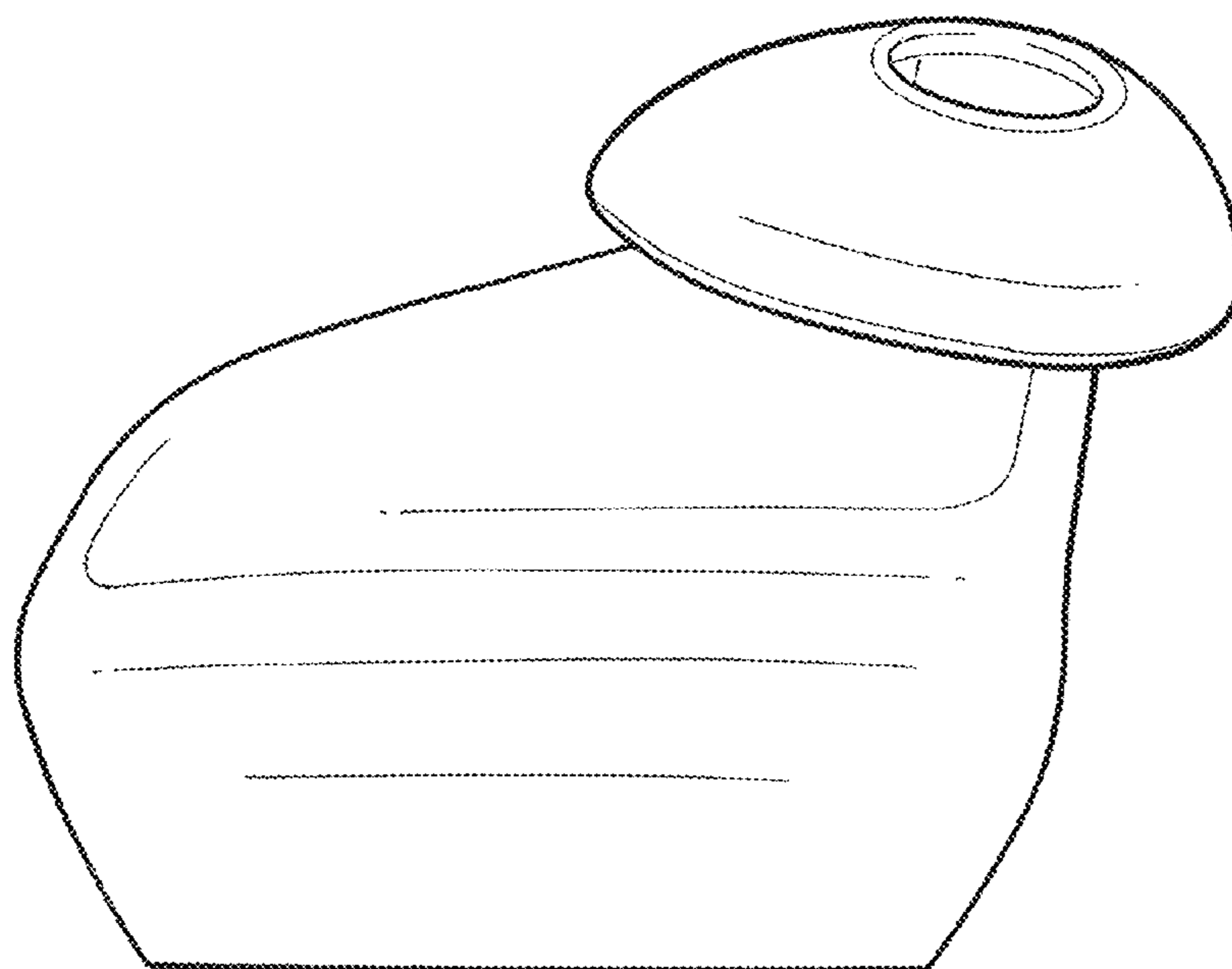

FIG. 6

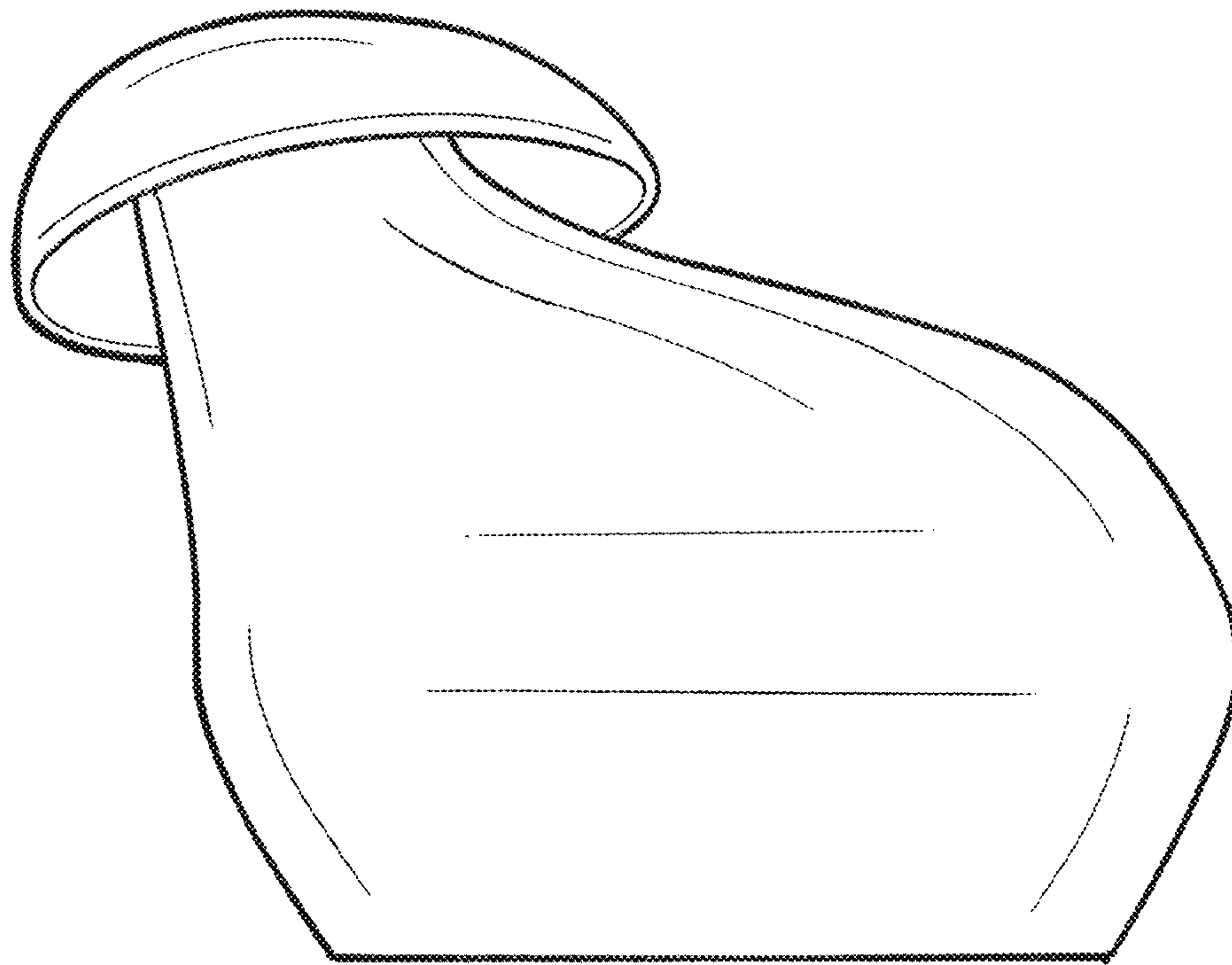

FIG. 7

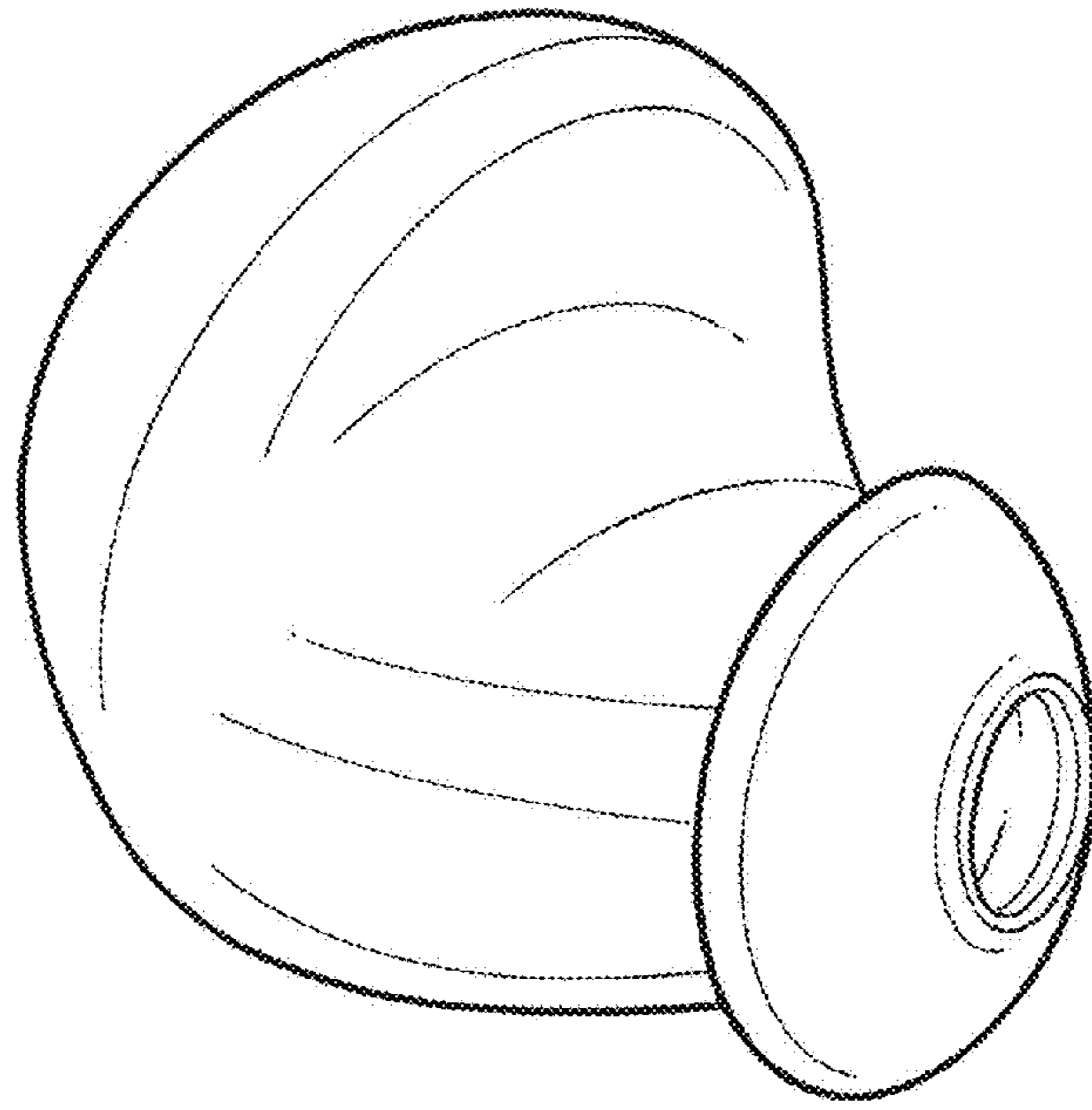

FIG. 8

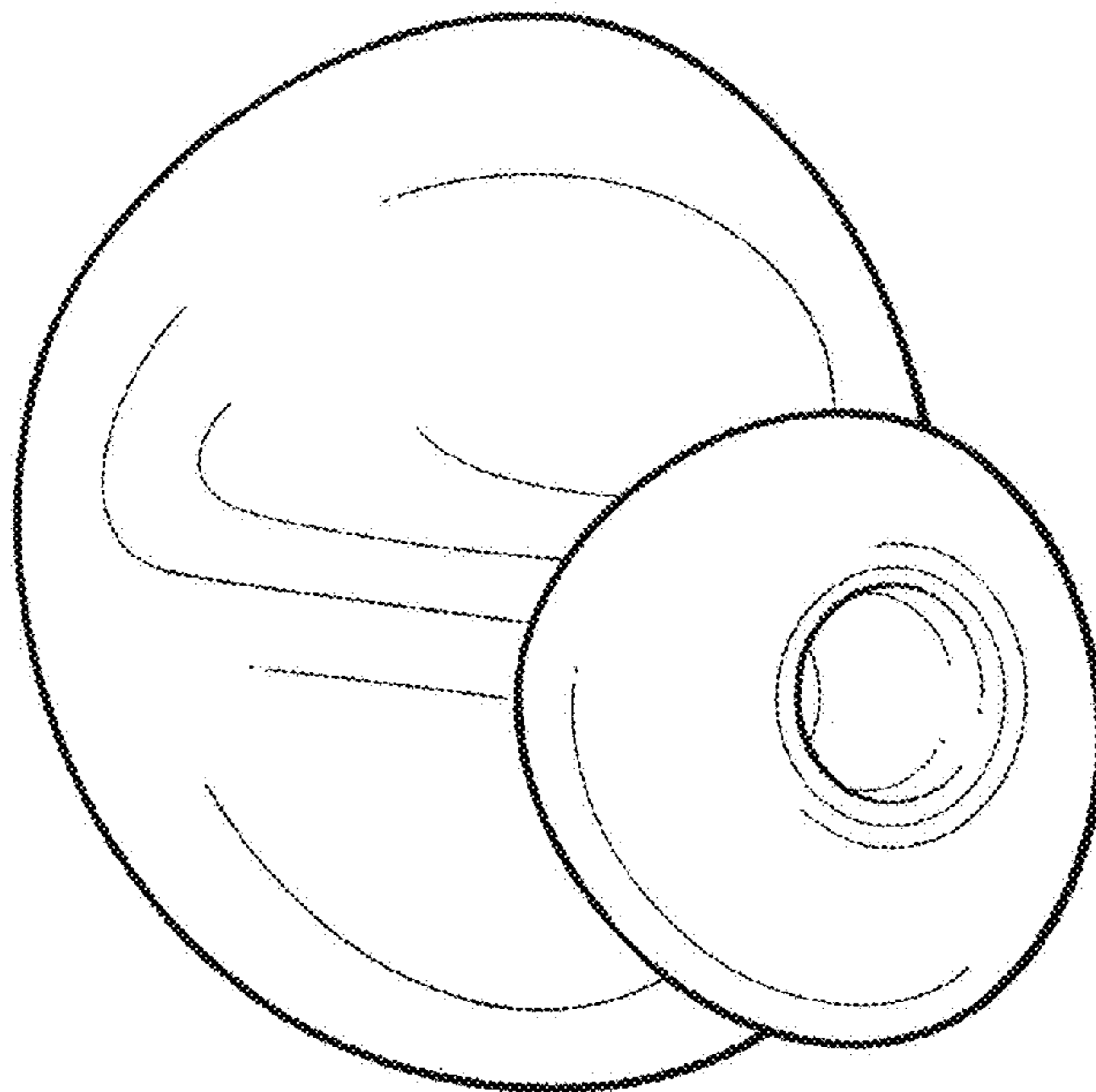

FIG. 9

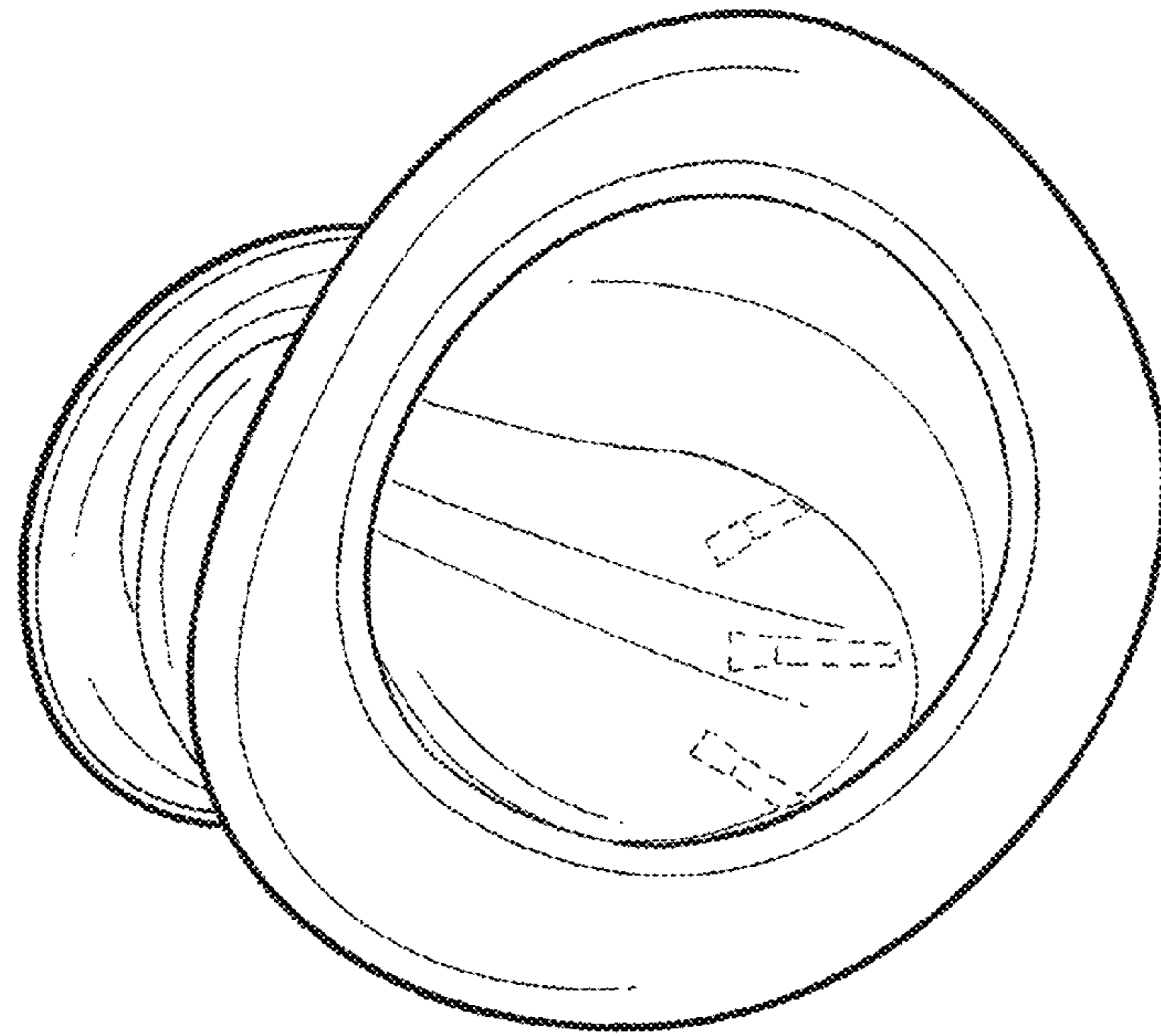

FIG. 10

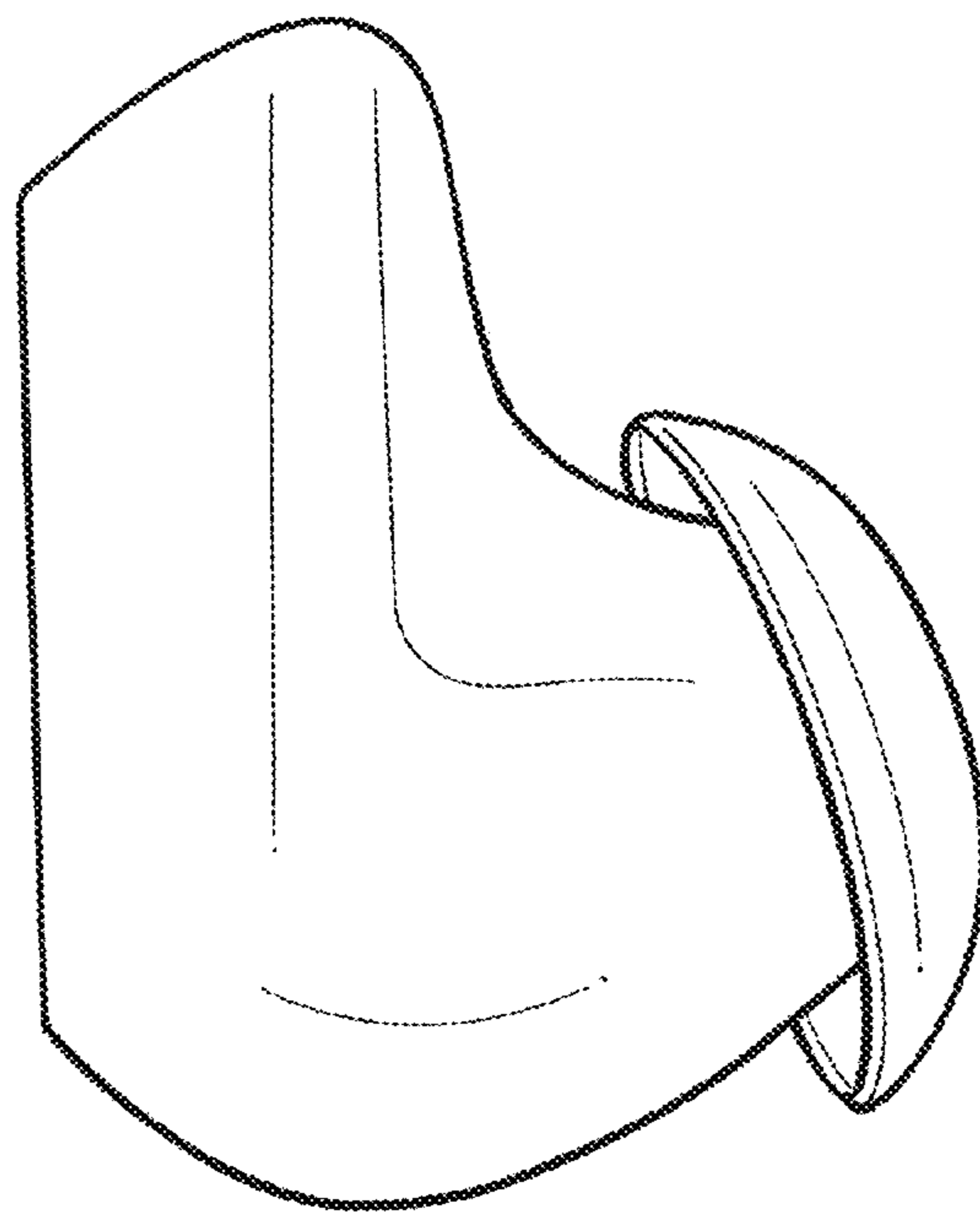

FIG. 11



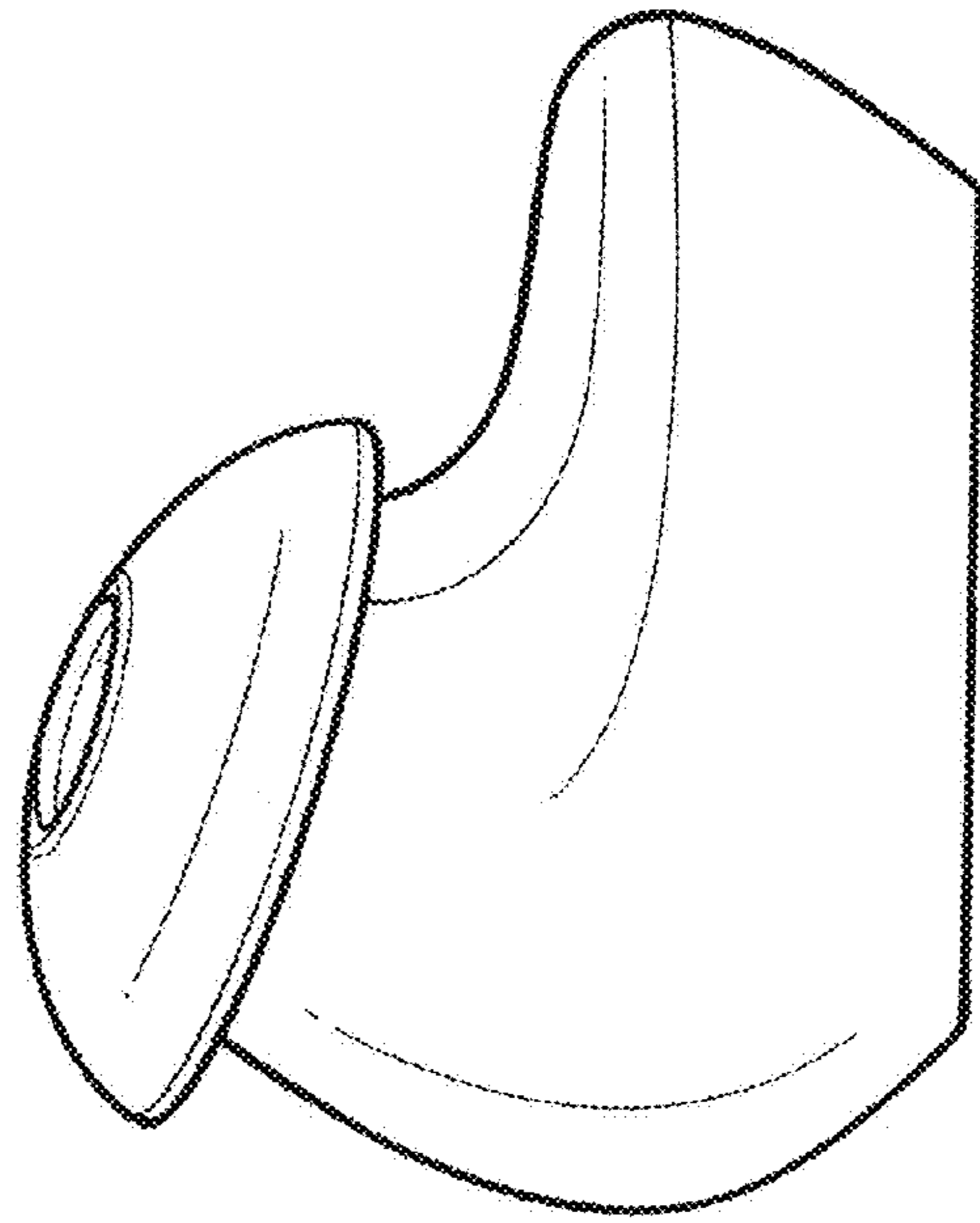

FIG. 12

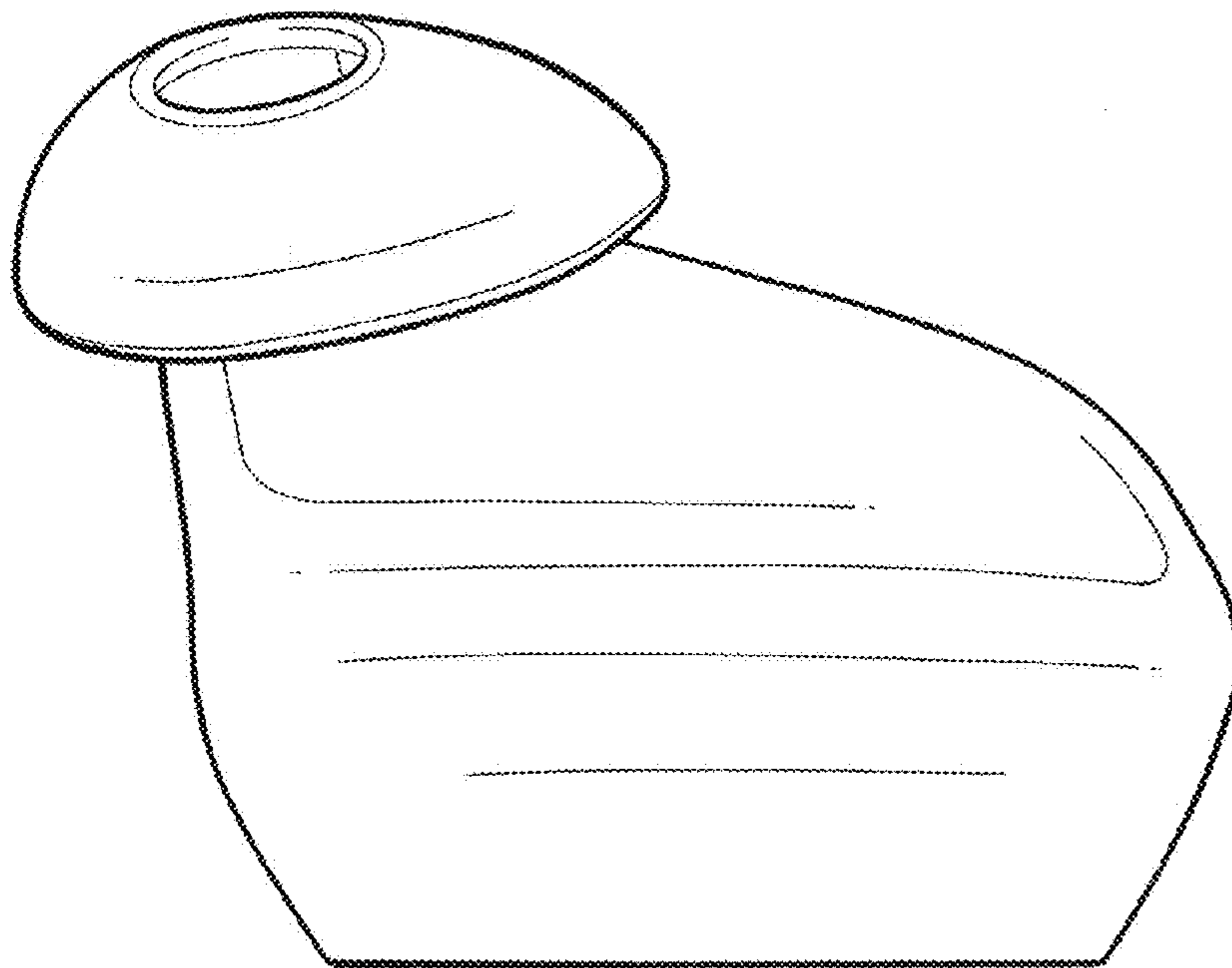

FIG. 13

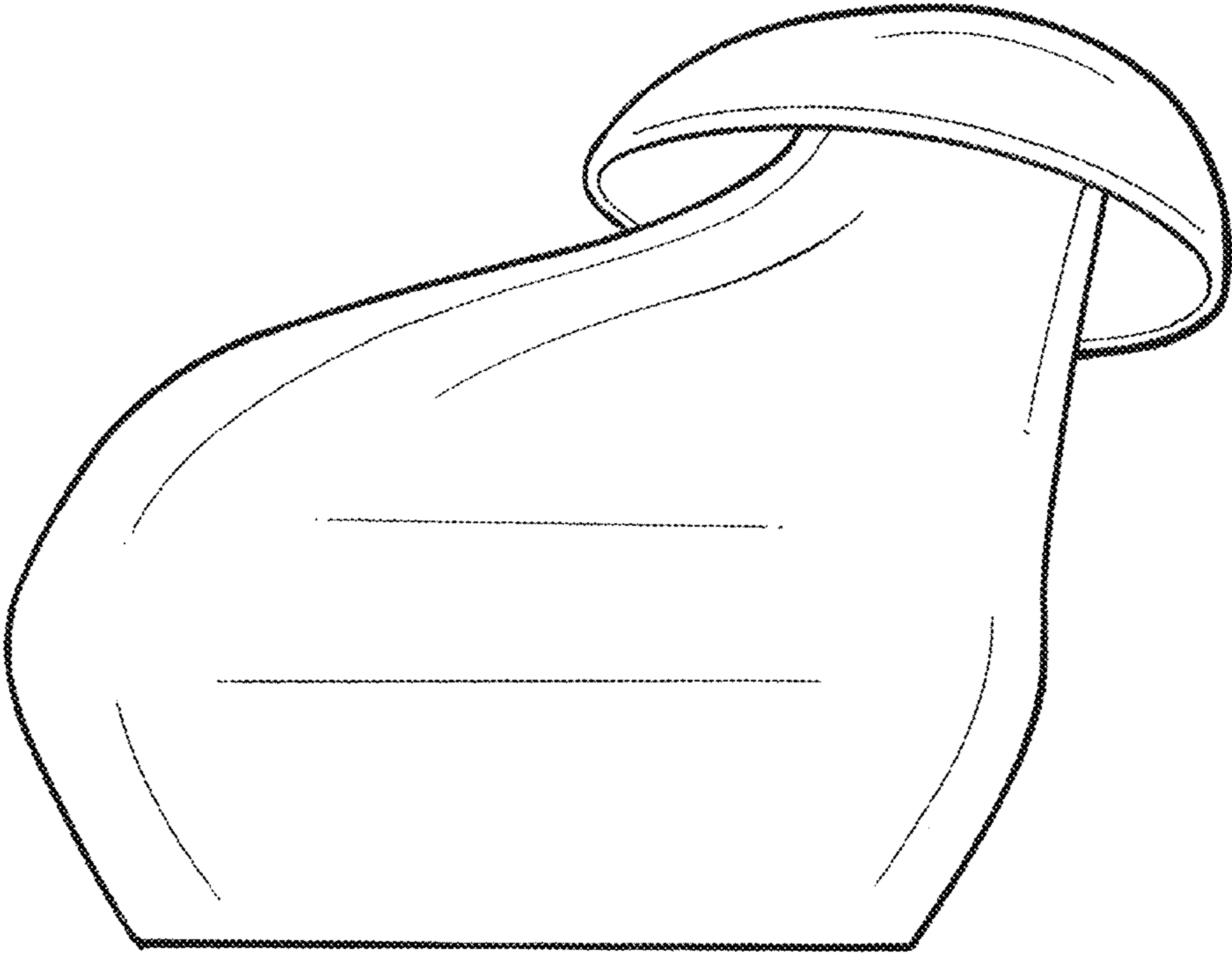

FIG. 14