



US00D773400S

(12) **United States Design Patent** (10) **Patent No.:** **US D773,400 S**
Koenig (45) **Date of Patent:** **** Dec. 6, 2016**

- (54) **ELECTRONIC CABLE**
- (71) Applicant: **AP Specialties**, San Clemente, CA (US)
- (72) Inventor: **Aaron Koenig**, San Clemente, CA (US)
- (73) Assignee: **AP Specialties**, San Clemente, CA (US)
- (**) Term: **14 Years**
- (21) Appl. No.: **29/521,464**
- (22) Filed: **Mar. 24, 2015**
- (51) **LOC (10) Cl.** **13-03**
- (52) **U.S. Cl.**
USPC **D13/153**
- (58) **Field of Classification Search**
USPC D13/153, 107, 123, 128, 130, 132, 133,
D13/137.1, 137.2, 137.4, 139.1, 139.3,
D13/139.4, 139.6, 139.7, 139.8, 164;
D7/300.2; D14/205, 228; D5/99;
174/28, 36, 93, 71 R, 102 R, 106 R, 107,
174/116, 117 F, 121 R, 121 SR; 428/592
CPC H01R 13/7036; H02G 3/14; F21S 4/001
See application file for complete search history.

(56) **References Cited**
U.S. PATENT DOCUMENTS

D548,700 S *	8/2007	Ledbetter	D13/147
D586,752 S *	2/2009	Diamond	D13/147
D586,753 S *	2/2009	Diamond	D13/147
D593,954 S *	6/2009	Lee	D13/133
D628,537 S *	12/2010	Nagata	D13/147
D635,930 S *	4/2011	Li	D13/147
D636,337 S *	4/2011	Smith	D13/147
D679,656 S *	4/2013	Richards	D13/146
D684,539 S	6/2013	Akana et al.		
D684,976 S	6/2013	Akana et al.		
8,461,465 B2	6/2013	Golko et al.		
8,561,879 B2	10/2013	Jol et al.		
D694,243 S	11/2013	Akana et al.		
D699,188 S	2/2014	Akana et al.		
D703,145 S	4/2014	Akana et al.		

D705,176 S	5/2014	Akana et al.		
D705,178 S *	5/2014	Olsson	D13/153
D707,680 S	6/2014	Akana et al.		
D707,681 S	6/2014	Akana et al.		
D713,350 S	9/2014	Akana et al.		
D713,351 S	9/2014	Akana et al.		

(Continued)

FOREIGN PATENT DOCUMENTS

WO 2011150403 A1 12/2011

Primary Examiner — Wan Laymon

Assistant Examiner — Mark Booker

(74) *Attorney, Agent, or Firm* — Lerner, David, Littenberg, Krumholz & Mentlik, LLP

(57) **CLAIM**

The ornamental design for an electronic cable, as shown and described.

DESCRIPTION

FIG. 1 is a perspective view of an electronic cable showing my design;
 FIG. 2 is a right side view thereof;
 FIG. 3 is a left side view thereof;
 FIG. 4 is a front side view thereof;
 FIG. 5 is a back side view thereof;
 FIG. 6 is a top view thereof;
 FIG. 7 is a bottom view thereof;
 FIG. 8 is a perspective view of the second embodiment of an electronic cable showing my design;
 FIG. 9 is a right side view thereof;
 FIG. 10 is a left side view thereof;
 FIG. 11 is a front side view thereof;
 FIG. 12 is a back side view thereof;
 FIG. 13 is a top view thereof; and,
 FIG. 14 is a bottom view thereof.

The broken lines shown in the drawings represent portions of the electronic cable that form no part of the claimed design.

1 Claim, 6 Drawing Sheets

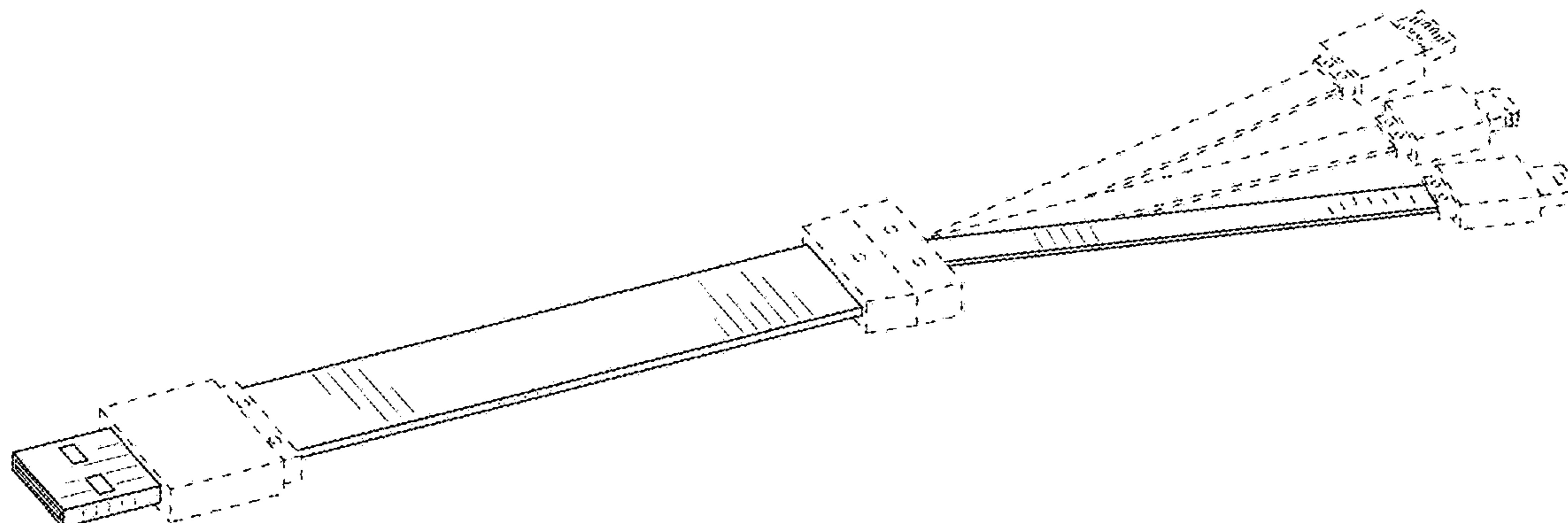

(56)

References Cited

U.S. PATENT DOCUMENTS

D713,352 S 9/2014 Akana et al.
D713,353 S 9/2014 Akana et al.
D715,741 S * 10/2014 Dallmeyer D13/146
D716,234 S 10/2014 Tien

D723,474 S * 3/2015 Olsson D13/153
D728,485 S * 5/2015 Rostami D13/153
D743,965 S * 11/2015 Laffon de Mazieres D13/154
D745,464 S * 12/2015 Koenig D13/147
D745,851 S * 12/2015 Beck D13/153
D757,649 S * 5/2016 Pisharodi D13/107
2014/0136863 A1 5/2014 Fritchman et al.

* cited by examiner

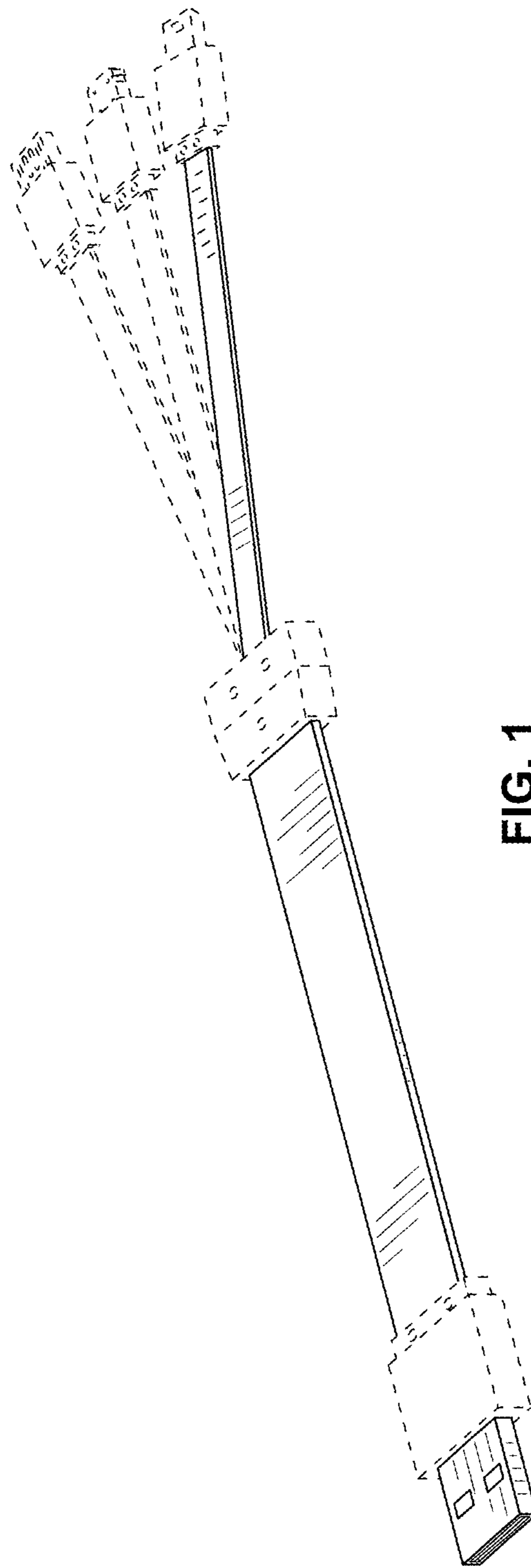

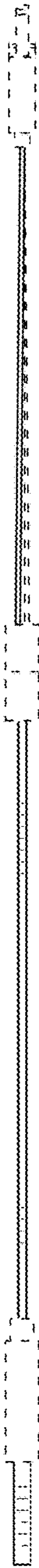

FIG. 2

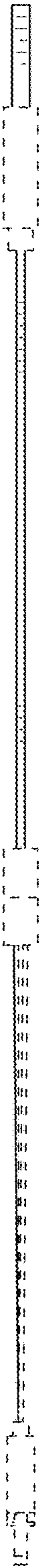

FIG. 3

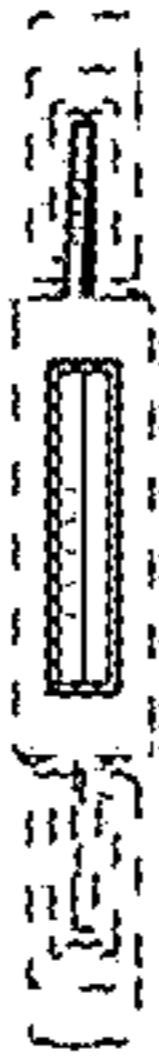

FIG. 5



FIG. 4

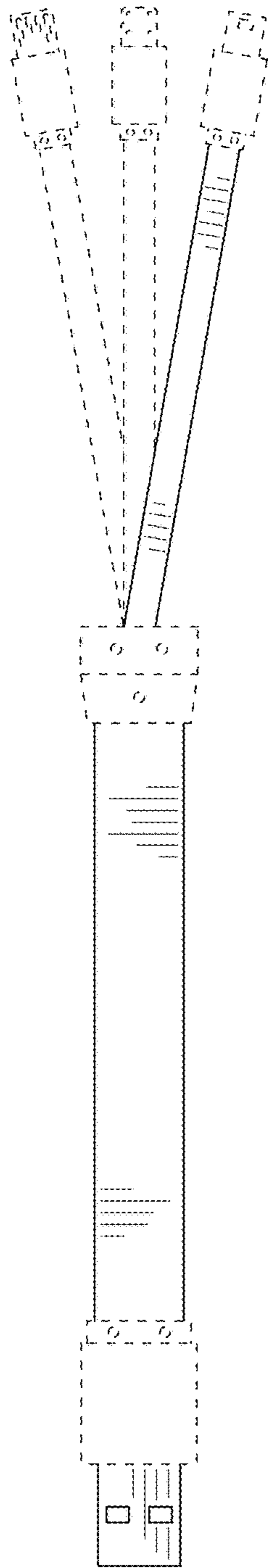

FIG. 6

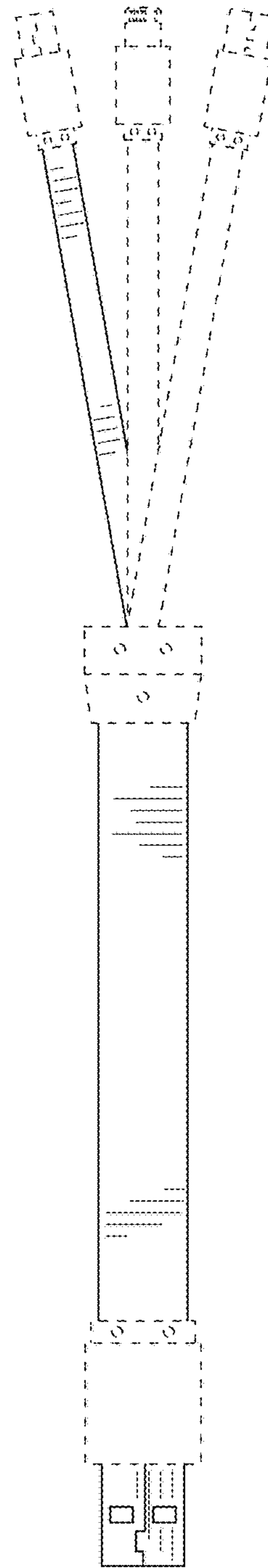

FIG. 7

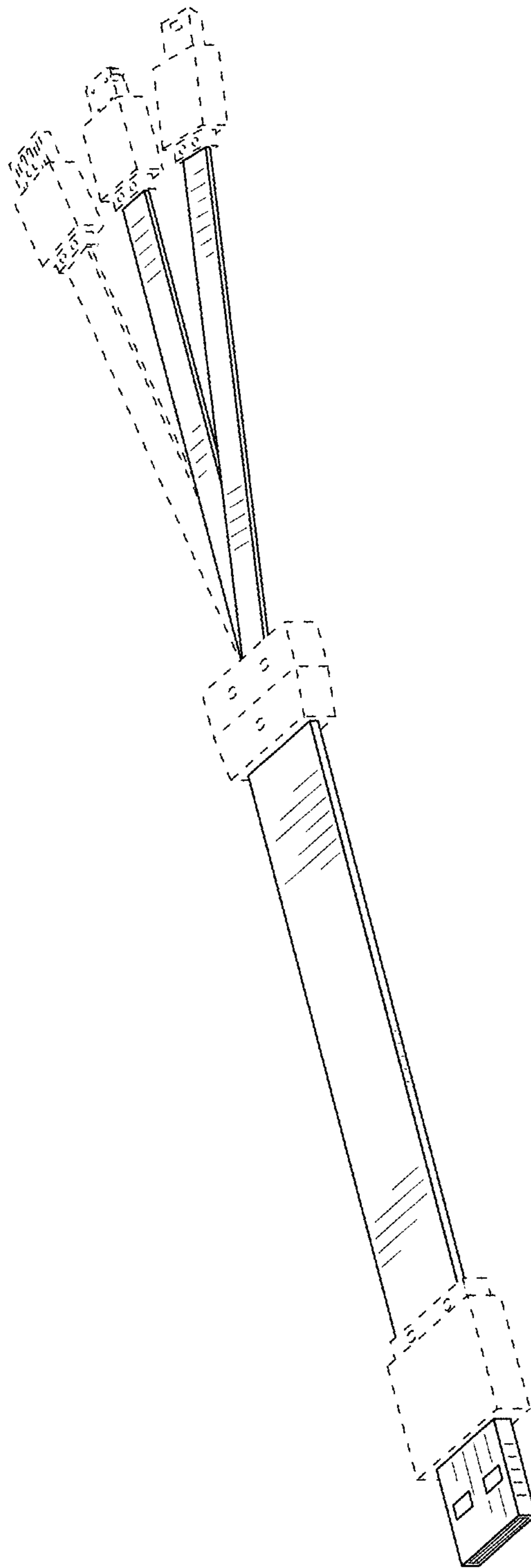

FIG. 8

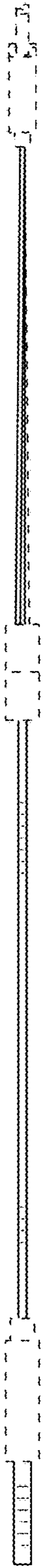

FIG. 9

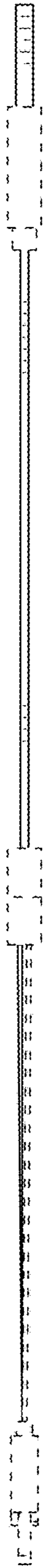

FIG. 10

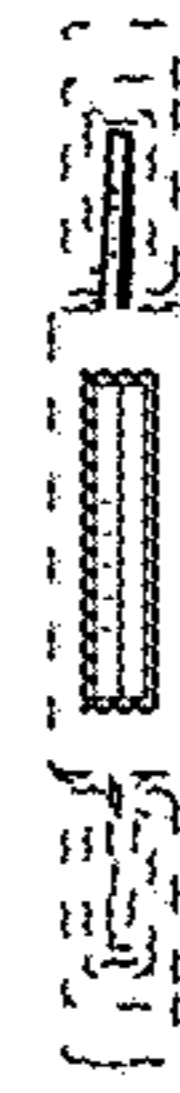

FIG. 11

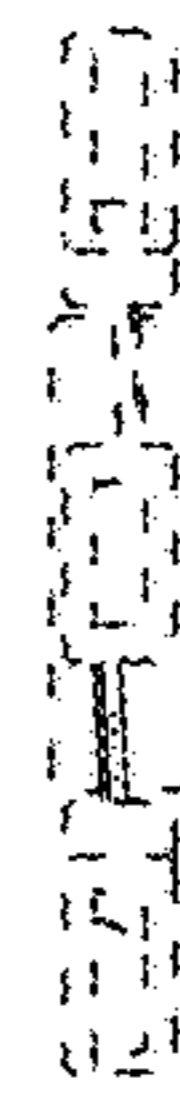

FIG. 12

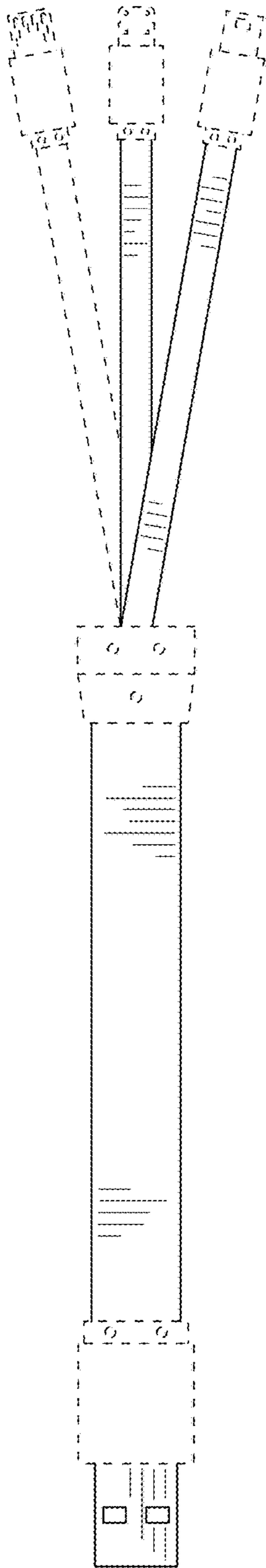

FIG. 13

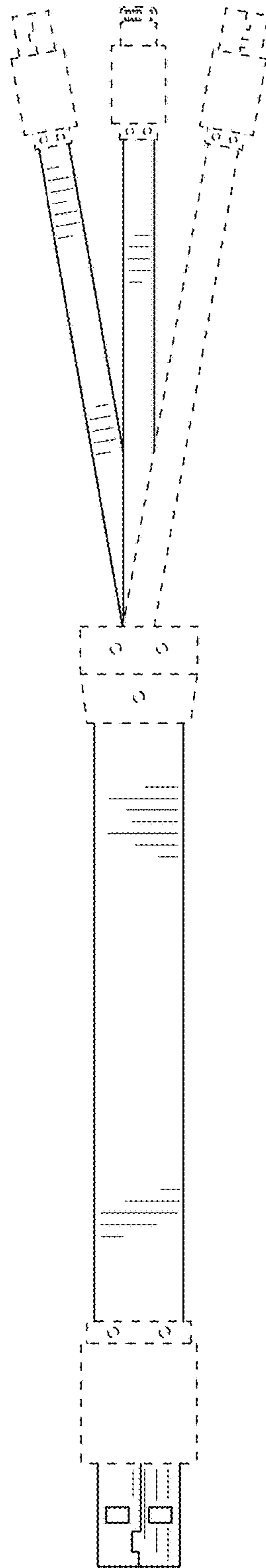

FIG. 14