



US00D773378S

(12) **United States Design Patent**
Sagen et al.

(10) **Patent No.:** **US D773,378 S**
(45) **Date of Patent:** **** Dec. 6, 2016**

- (54) **VEHICLE TOP CARRIER**
- (71) Applicant: **Yakima Products, Inc.**, Beaverton, OR (US)
- (72) Inventors: **Jason A. Sagen**, Portland, OR (US);
David Condon, Beaverton, OR (US);
Ashley Hoch, Portland, OR (US)
- (73) Assignee: **Yakima Products, Inc.**, Lake Oswego, OR (US)

(**) Term: **15 Years**

(21) Appl. No.: **29/529,593**

(22) Filed: **Jun. 9, 2015**

(51) **LOC (10) Cl.** **12-16**

(52) **U.S. Cl.**
USPC **D12/413**

(58) **Field of Classification Search**
USPC D12/406-414; D32/35, 58; D6/317-319,
D6/513-514
CPC B62J 9/003; B62J 7/06; B62J 7/04;
B62J 9/001
See application file for complete search history.

(56) **References Cited**

U.S. PATENT DOCUMENTS

D289,151 S	4/1987	Forsman
D297,629 S	9/1988	Breger
D297,630 S	9/1988	Breger
D297,631 S	9/1988	Breger
D299,914 S	2/1989	Witte
D326,634 S	6/1992	Seaver
D342,049 S	12/1993	Harrison
D373,105 S	8/1996	Imotani
D406,558 S	3/1999	Pendergraph
D412,881 S	8/1999	Behringer
D419,954 S	2/2000	Bradt

D420,321 S 2/2000 McCoy et al.
6,234,371 B1 5/2001 Sinn
D462,312 S 9/2002 Klein
(Continued)

Primary Examiner — Katrina A Betton
(74) *Attorney, Agent, or Firm* — Kolisch Hartwell, P.C.

(57) **CLAIM**

The ornamental design for a vehicle top carrier, as shown and described.

DESCRIPTION

FIG. 1 is an upper, front, and left-side perspective view of a first embodiment of a vehicle top carrier showing the new design;
 FIG. 2 is a lower, rear, and right-side perspective view thereof;
 FIG. 3 is a plan view thereof;
 FIG. 4 is a right side elevational view thereof, the left side elevational view is a mirror image of the right side elevational view, and is not shown;
 FIG. 5 is a bottom view thereof;
 FIG. 6 is a front elevational view thereof;
 FIG. 7 is a rear elevational view thereof;
 FIG. 8 is an upper, front, and left-side perspective view of a second embodiment of a vehicle top carrier showing the new design;
 FIG. 9 is a lower, rear, and right-side perspective view thereof;
 FIG. 10 is a plan view thereof;
 FIG. 11 is a right side elevational view thereof, the left side elevational view is a mirror image of the right side elevational view, and is not shown;
 FIG. 12 is a bottom view thereof;
 FIG. 13 is a front elevational view thereof; and,
 FIG. 14 is a rear elevational view thereof.
 The dashed lines shown in the drawings are included for illustrative purposes only and form no part of the claimed design.

1 Claim, 6 Drawing Sheets

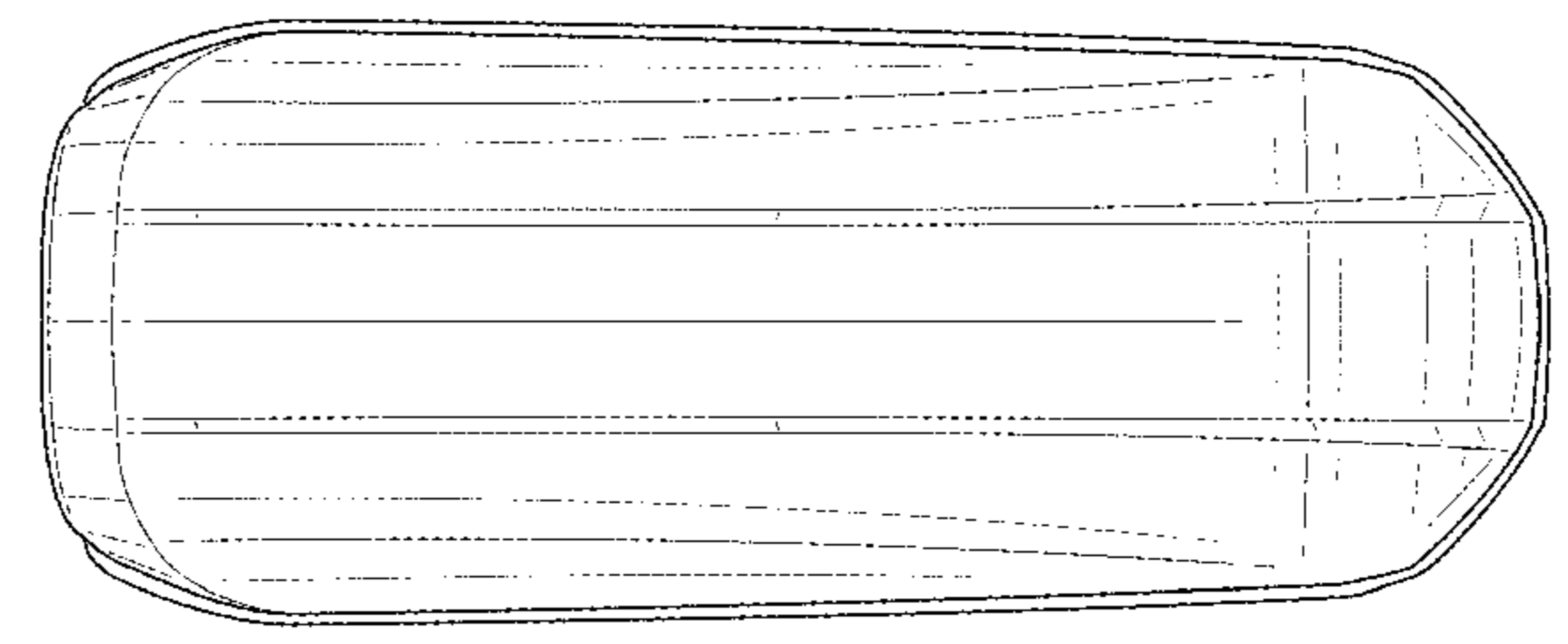
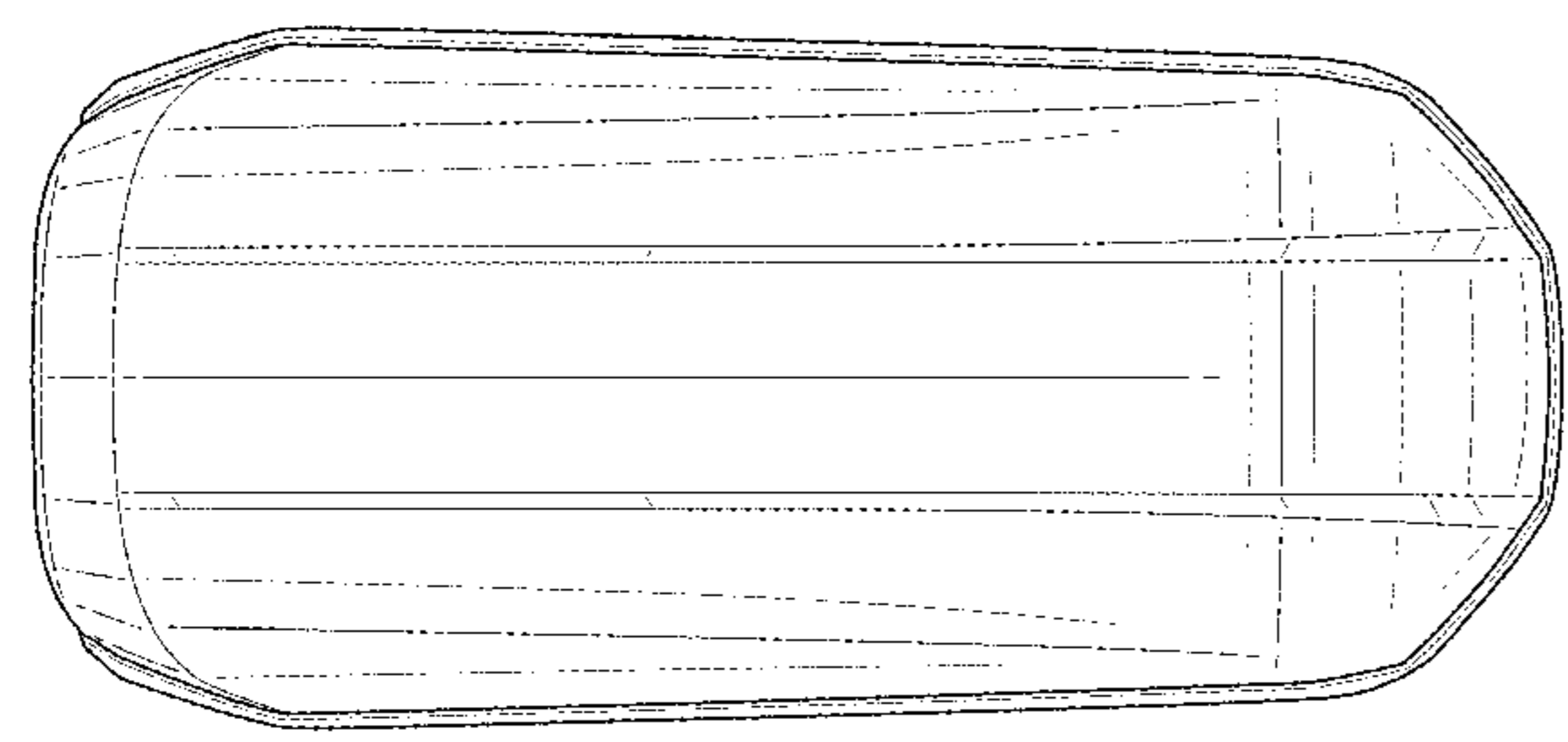

(56)

References Cited

U.S. PATENT DOCUMENTS

D489,674	S	5/2004	Settelmayer et al.	
D515,016	S	2/2006	Gruner	
D519,914	S	5/2006	Klein	
D527,337	S	8/2006	Klein	
D528,498	S	9/2006	Gruner	
D530,571	S	10/2006	Hemann et al.	
D543,929	S	6/2007	D'Andrea et al.	
D575,723	S	8/2008	Gruner	
D590,762	S	4/2009	Gruner	
D593,928	S	6/2009	Gruner	
D595,215	S	6/2009	Rasche	
D600,459	S	9/2009	Hanagan	
D630,157	S *	1/2011	Farber	D12/413
D636,326	S	4/2011	Robertson et al.	
D641,303	S *	7/2011	Gruner	D12/413
D642,970	S	8/2011	Elder et al.	
D643,798	S *	8/2011	Gruner	D12/413
D656,082	S *	3/2012	Gruner	D12/413
8,757,457	B2	6/2014	Settelmayer et al.	
D717,228	S	11/2014	Sagen	
D717,719	S *	11/2014	Sagen	D12/413
D722,006	S *	2/2015	Settelmayer	D12/413
D724,520	S *	3/2015	Gruner	D12/413
D726,638	S *	4/2015	Rupp	D12/413
D739,336	S *	9/2015	Berrey	D12/413
D746,217	S *	12/2015	Gruner	D12/413
2003/0205597	A1	11/2003	Ford et al.	
2004/0256427	A1	12/2004	Settelmayer et al.	
2007/0164066	A1	7/2007	Jones	
2010/0084447	A1	4/2010	Elliott et al.	

* cited by examiner

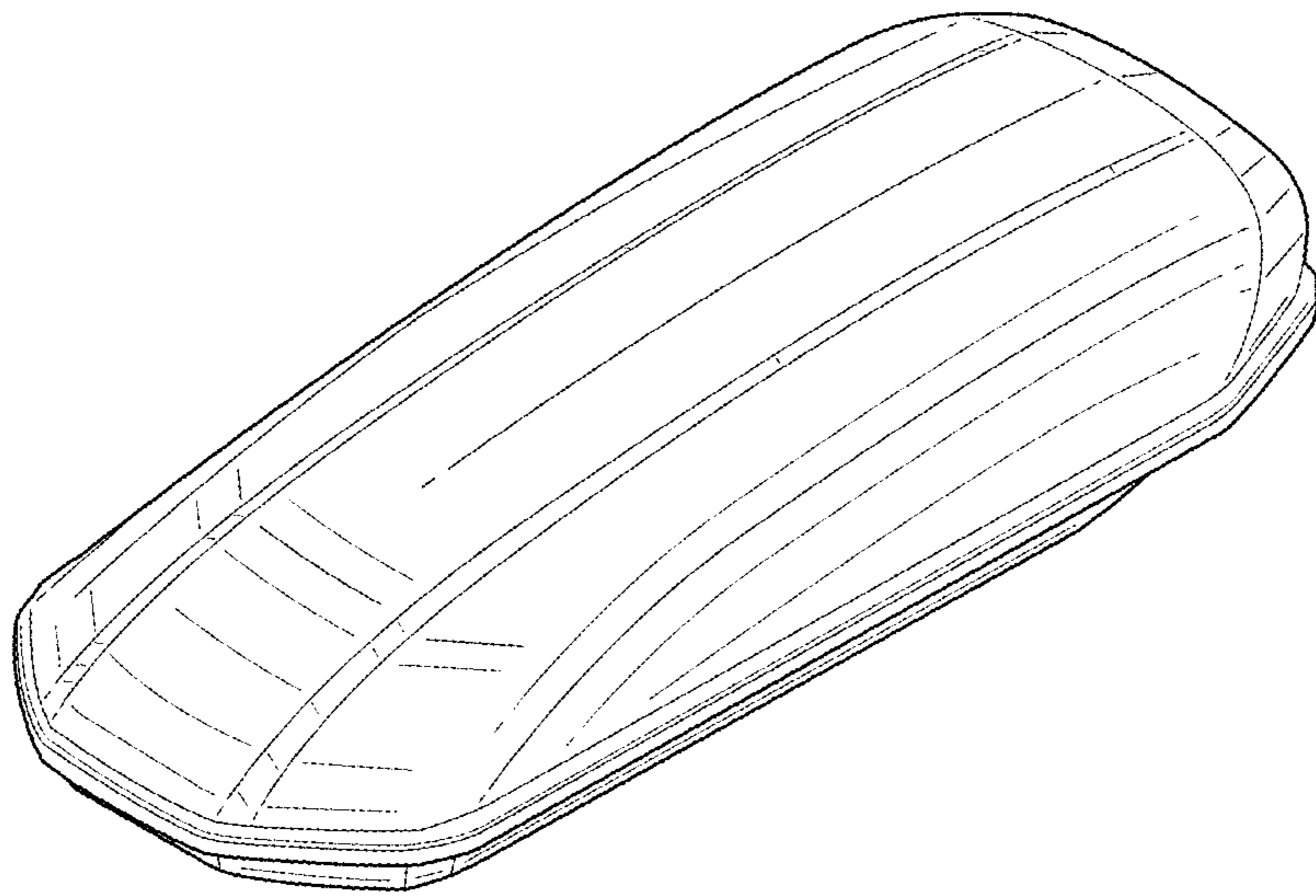

FIG. 1

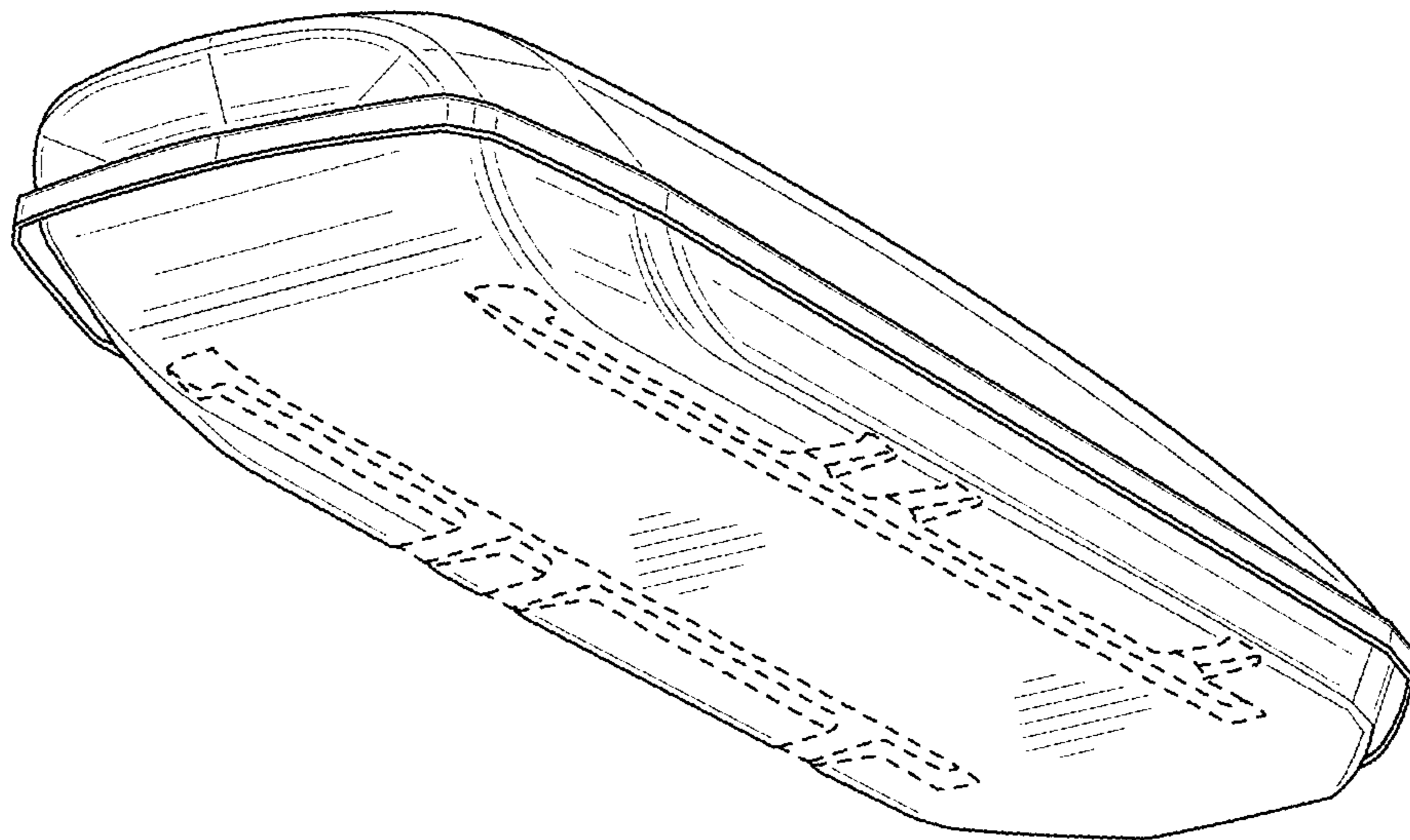

FIG. 2

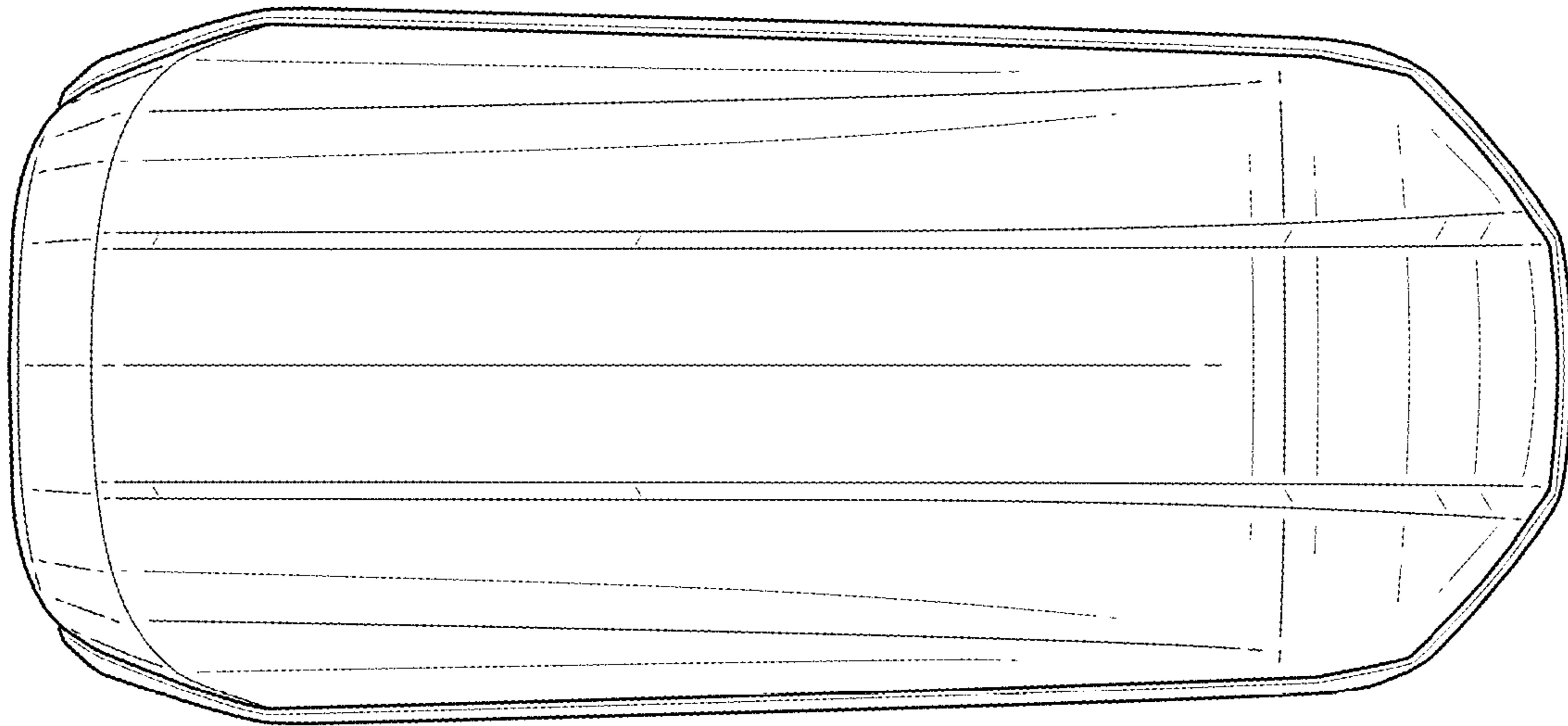

FIG. 3

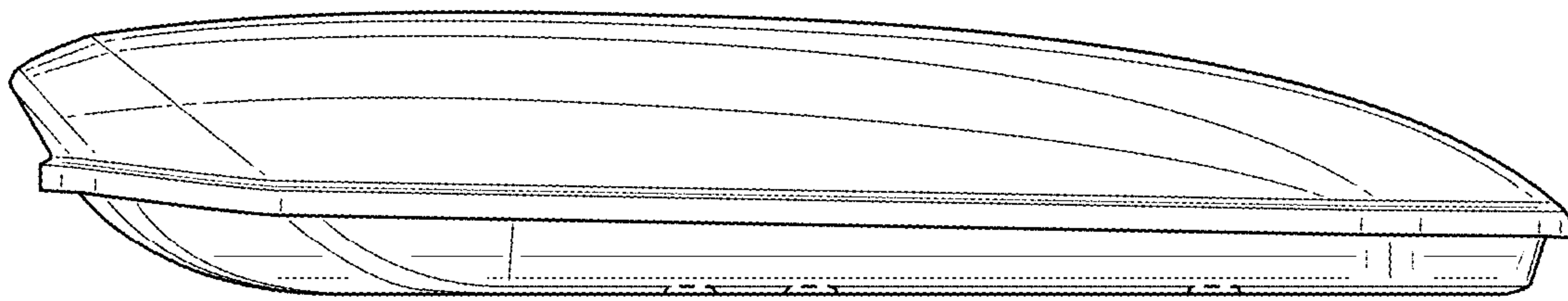

FIG. 4

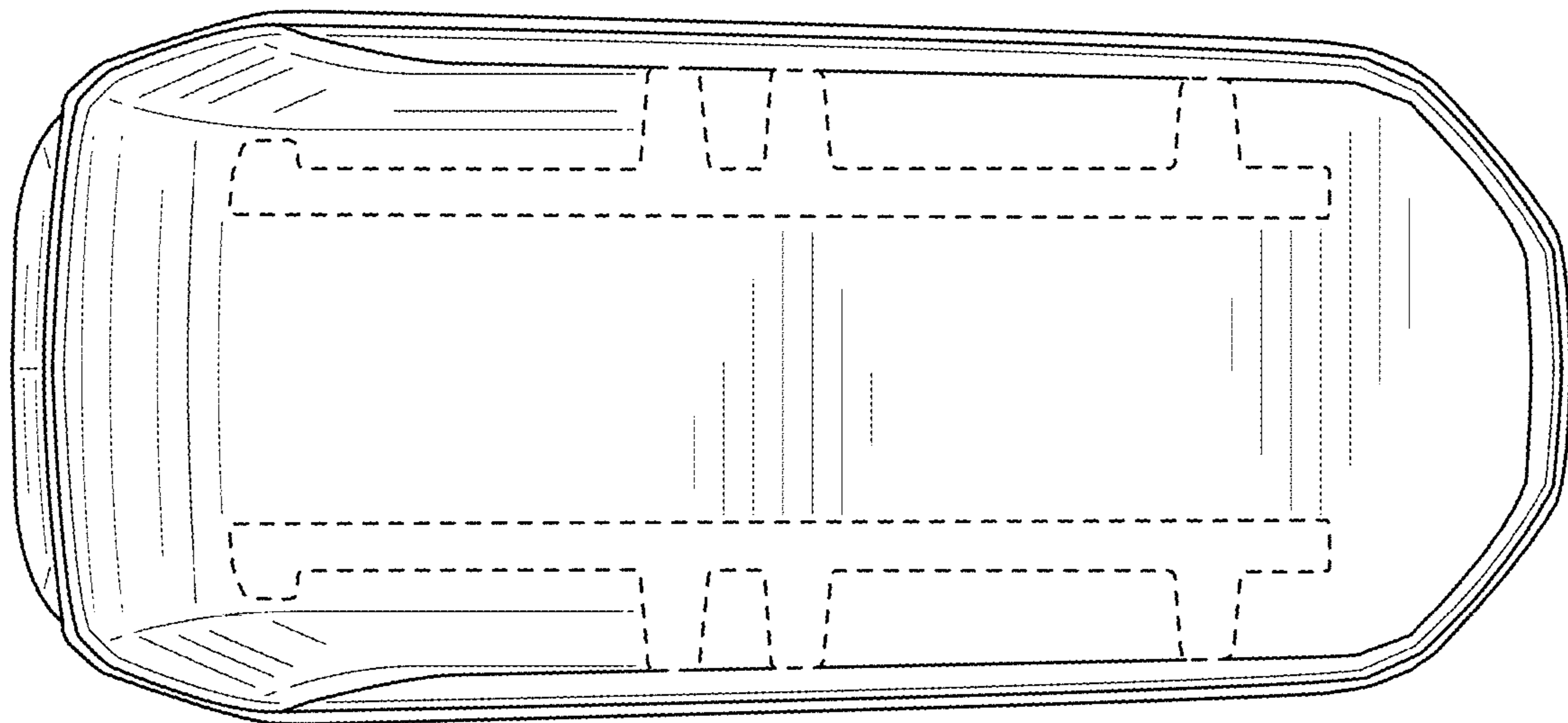

FIG. 5

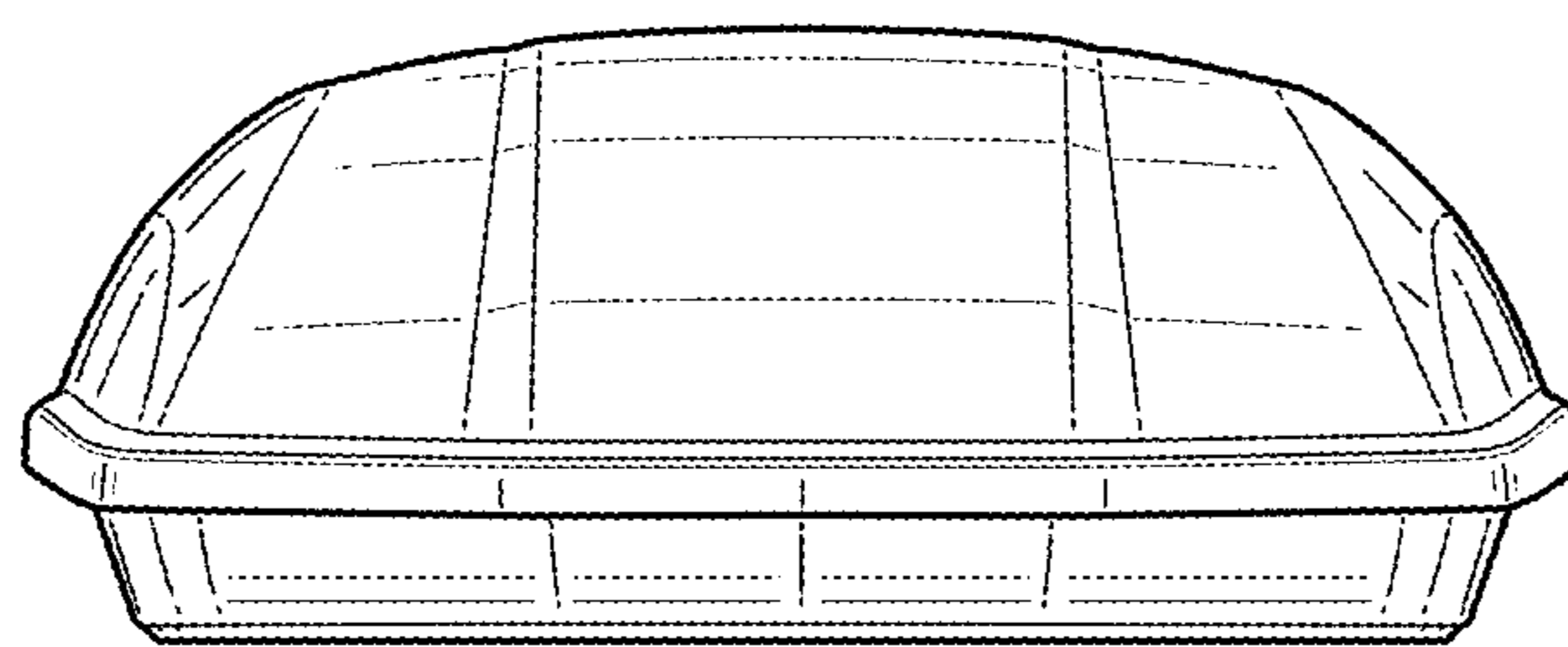

FIG. 6

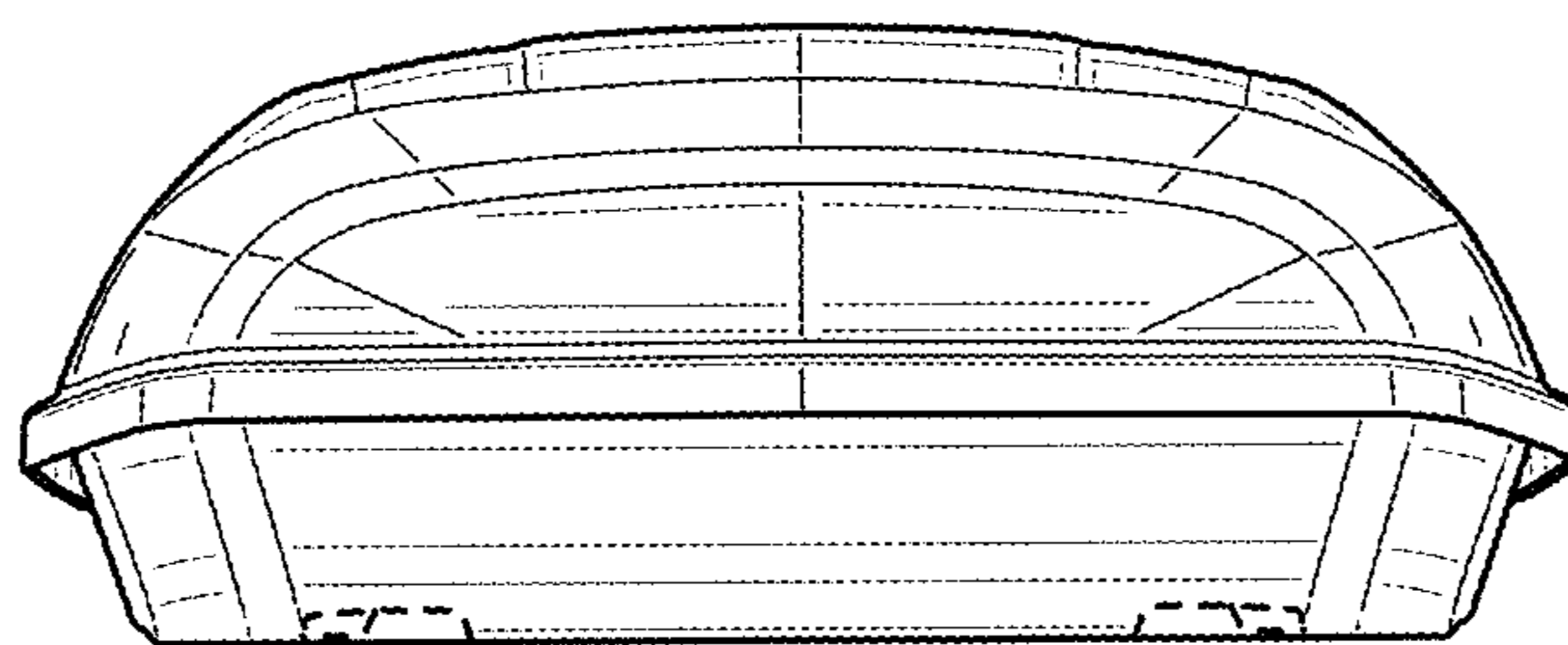

FIG. 7

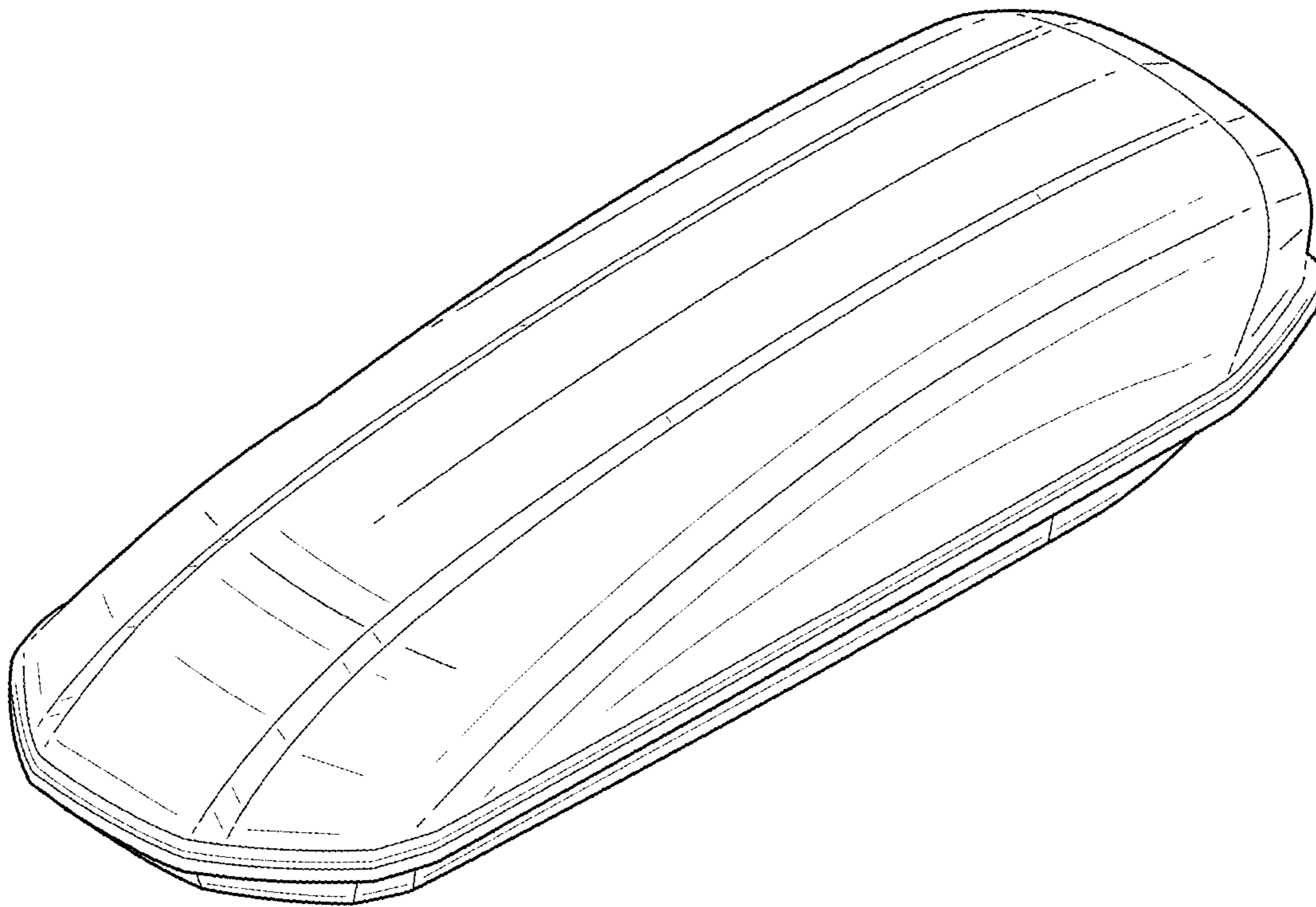

FIG. 8

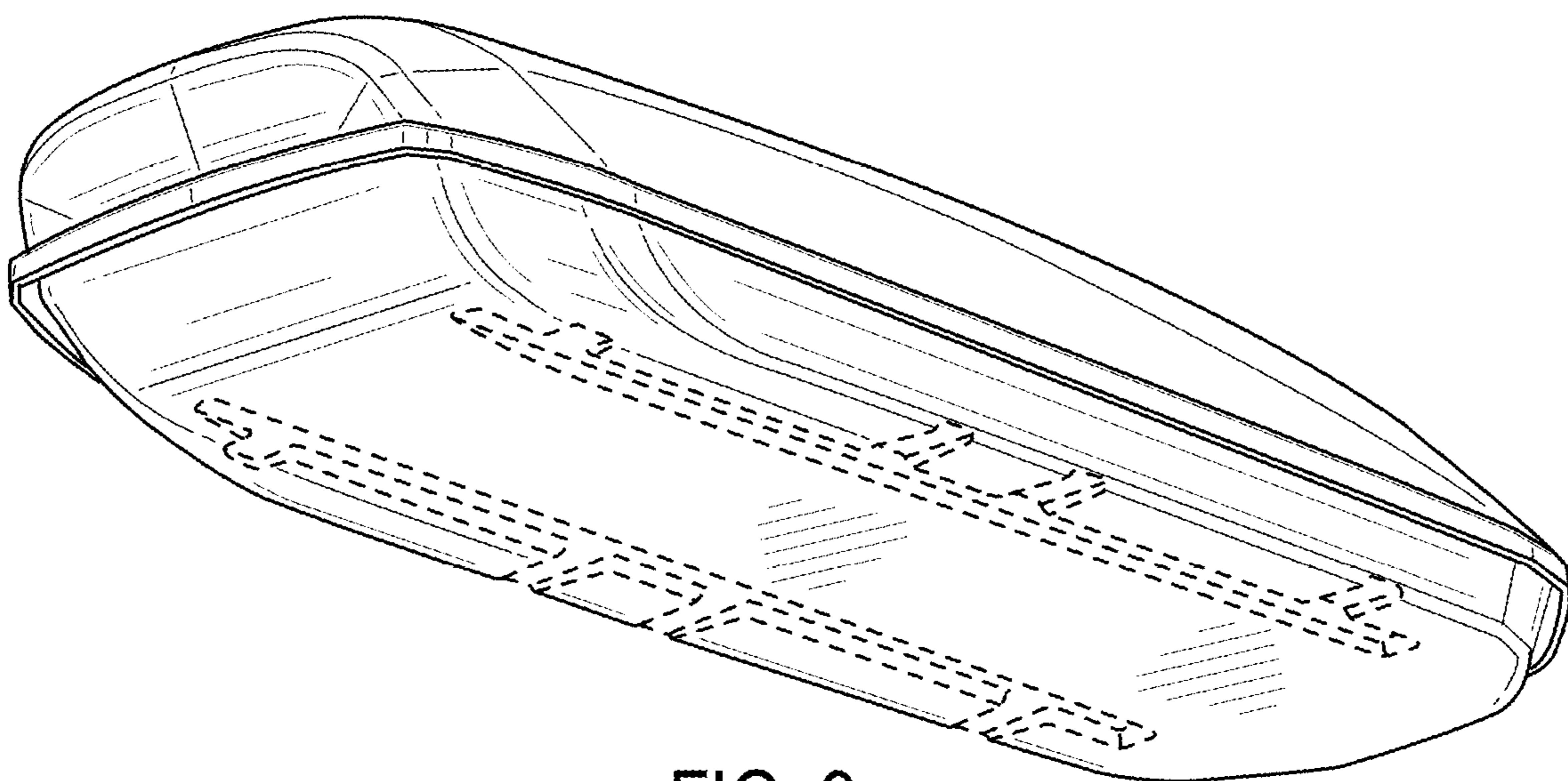

FIG. 9

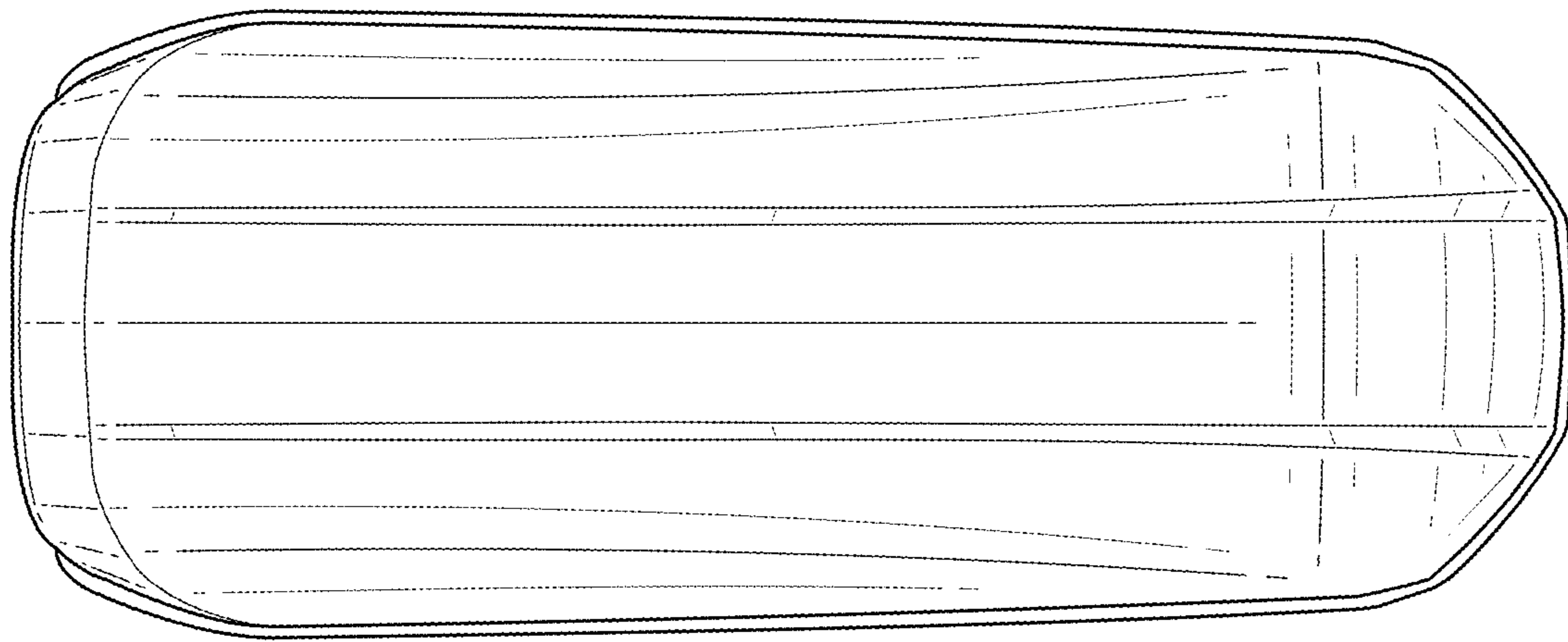

FIG. 10

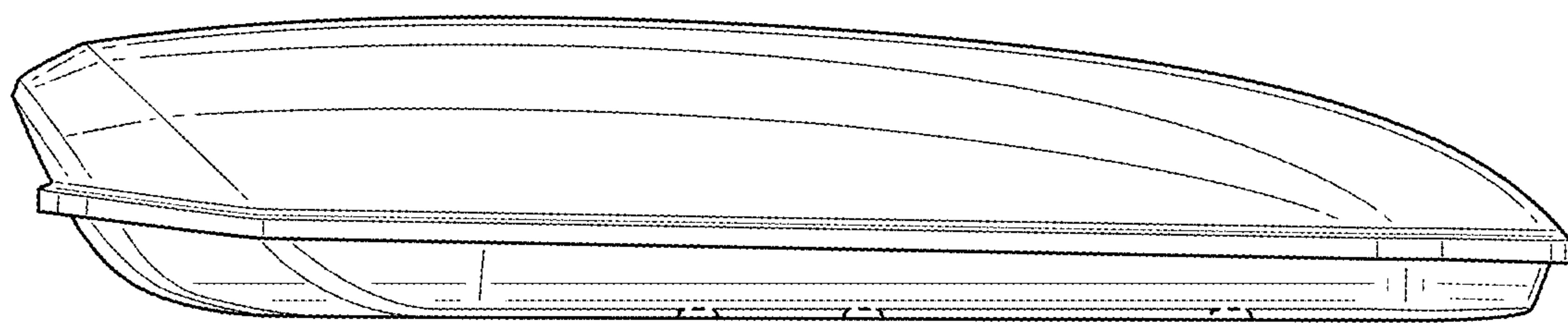

FIG. 11

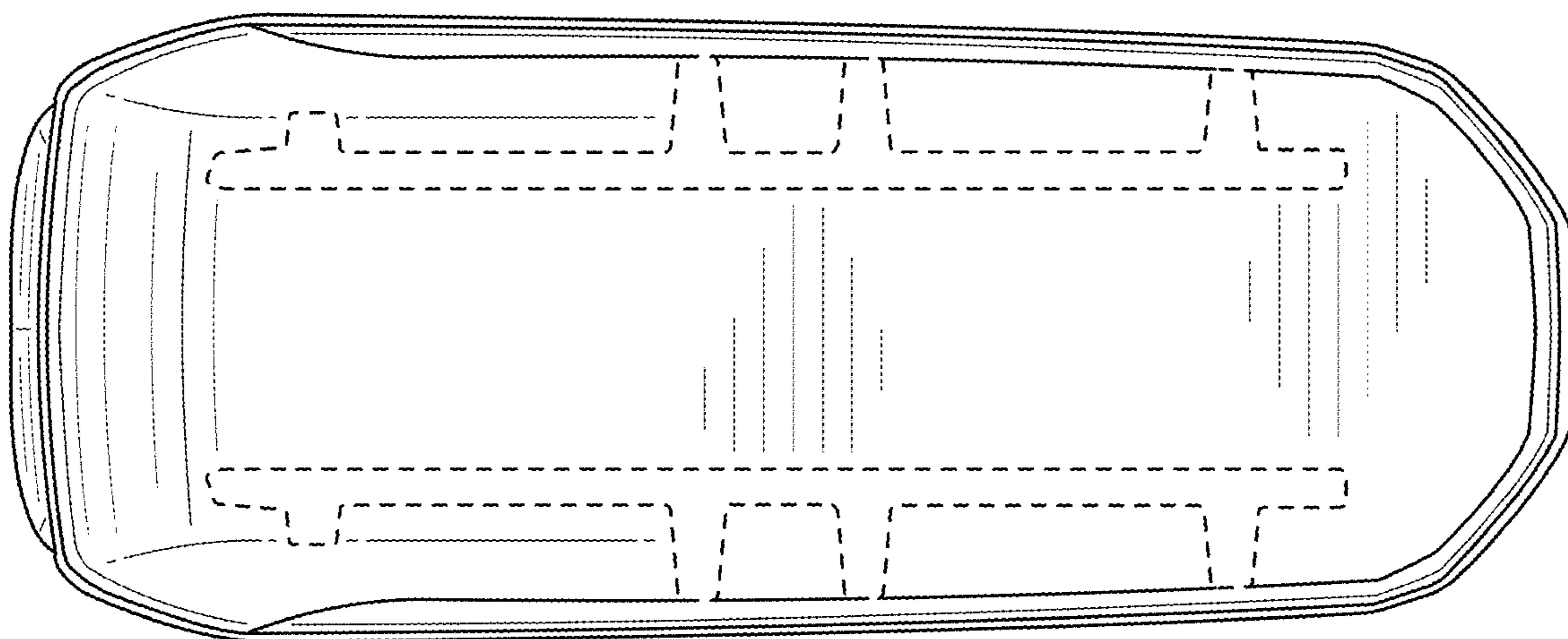

FIG. 12

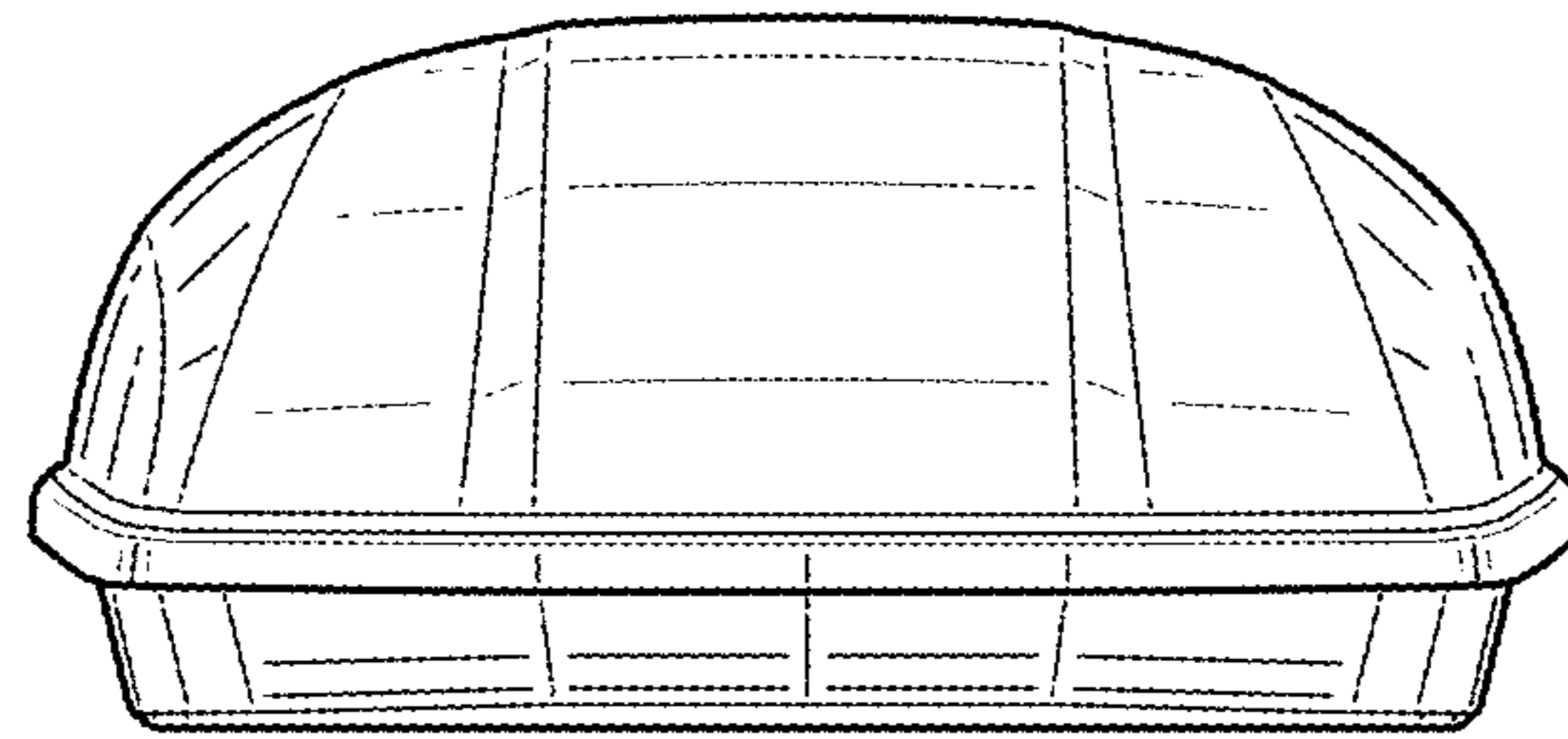

FIG. 13

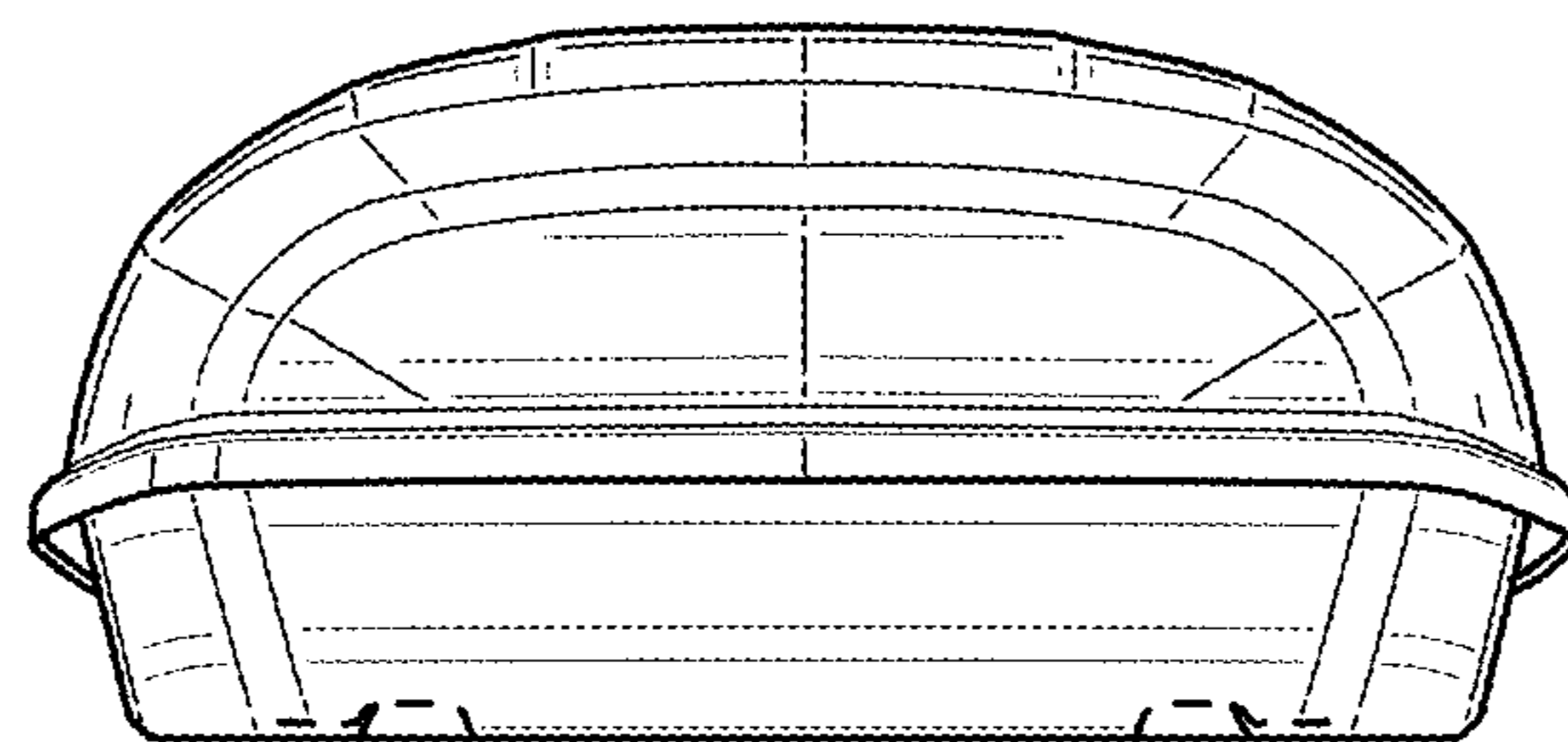

FIG. 14