



US00D773298S

(12) **United States Design Patent** (10) **Patent No.:** **US D773,298 S**
Hebert (45) **Date of Patent:** **** Dec. 6, 2016**

(54) **BOTTLE TOPPER**

(56) **References Cited**

(71) Applicant: **Eric Michael Hebert**, Harrisburg, NC (US)

U.S. PATENT DOCUMENTS

(72) Inventor: **Eric Michael Hebert**, Harrisburg, NC (US)

| | | | |
|----------------|--------|------------------|------------------------|
| D488,377 S * | 4/2004 | Shih | D9/443 |
| D639,657 S * | 6/2011 | Hoyt | D9/439 |
| D660,695 S * | 5/2012 | Ishizawa | D9/436 |
| D666,495 S * | 9/2012 | Biesecker | D9/445 |
| D675,895 S * | 2/2013 | Wisniewski | D8/38 |
| D678,740 S * | 3/2013 | Wisniewski | D8/38 |
| D706,597 S * | 6/2014 | Hebert | D8/38 |
| D707,513 S * | 6/2014 | Hebert | D8/38 |
| D708,517 S * | 7/2014 | Hebert | D9/441 |
| 8,783,486 B1 * | 7/2014 | Hoyt | B65D 79/005 215/355 |

(73) Assignee: **Fairly Odd Treasures, LLC.**, Harrisburg, NC (US)

(**) Term: **15 Years**

* cited by examiner

(21) Appl. No.: **29/537,689**

Primary Examiner — Sandra Morris

(22) Filed: **Aug. 28, 2015**

(51) **LOC (10) Cl.** **09-07**

(57) **CLAIM**

(52) **U.S. Cl.**
USPC **D9/451**

The ornamental design for a bottle topper, as shown and described.

(58) **Field of Classification Search**

DESCRIPTION

USPC .. D9/600-601, 614-629, 434-454; 206/457, 206/494, 459.5, 527, 540, 890; 229/116.1; 446/77; 215/381-384, 400; D7/514-516, D7/539, 544, 571, 579, 604, 613, D7/619.2, 628-630, 391-392.1
CPC B65D 67/00; B65D 81/36; B65D 81/60; B65D 81/368; B65D 2203/00; B65D 2203/02; B65D 51/245; B65D 81/365; B65D 81/366; A63H 33/16

FIG. 1 is a perspective view of a bottle topper showing my new design;
FIG. 2 is a front view thereof;
FIG. 3 is a back view thereof;
FIG. 4 is a top view thereof;
FIG. 5 is a bottom view thereof;
FIG. 6 is a right side view thereof; and,
FIG. 7 is a left side view thereof.

See application file for complete search history.

1 Claim, 7 Drawing Sheets

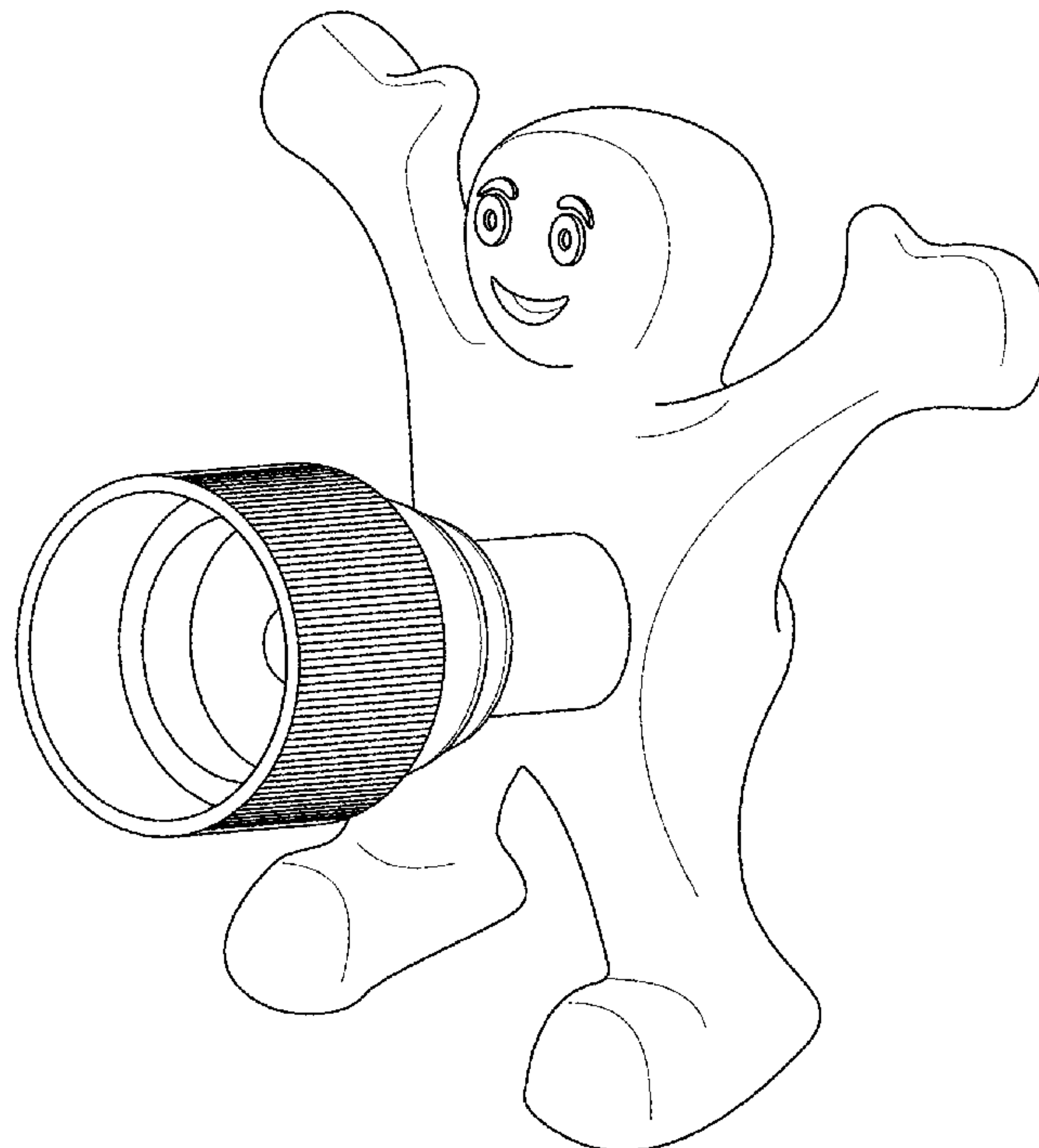

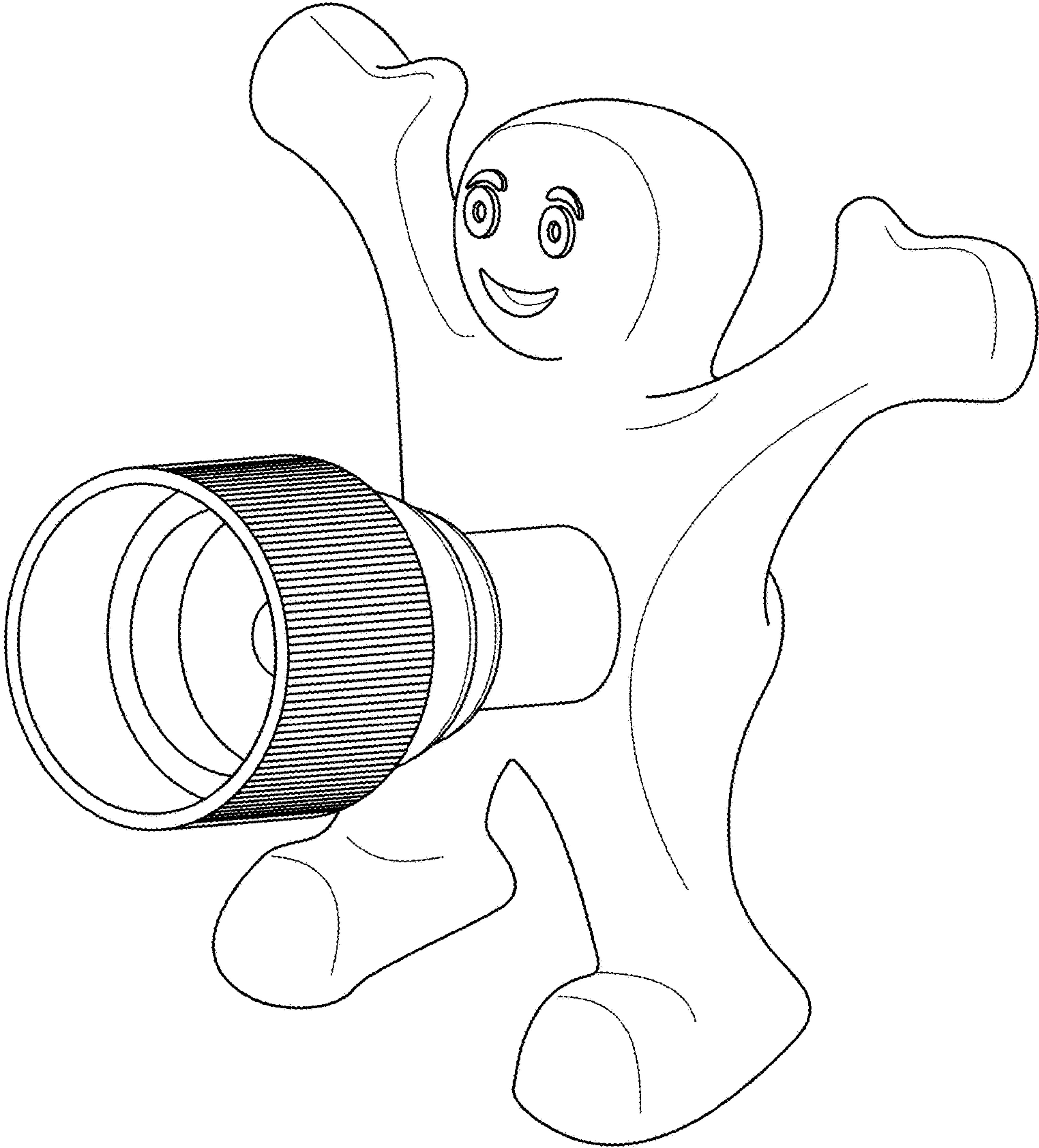

FIG. 1

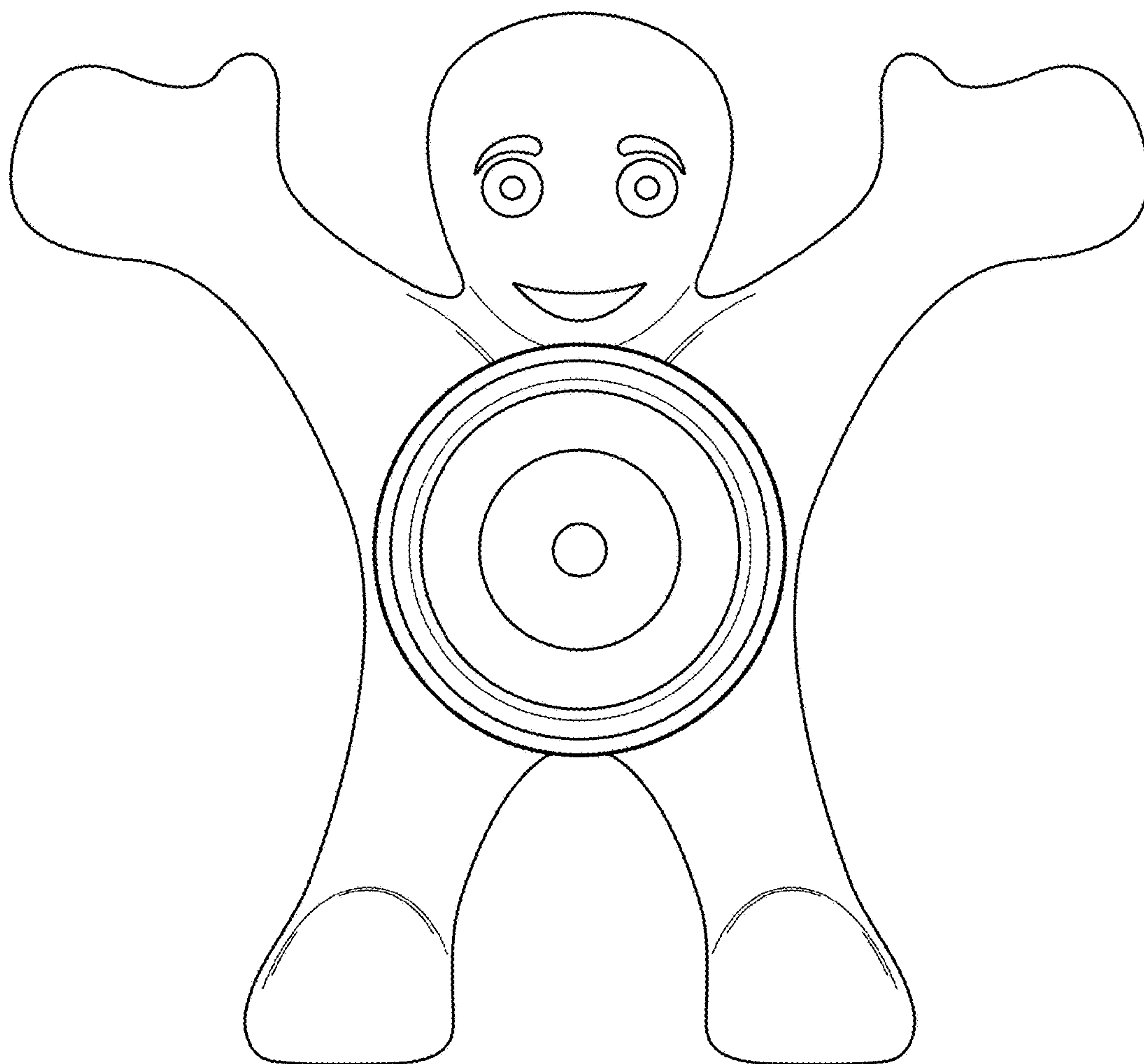

FIG. 2

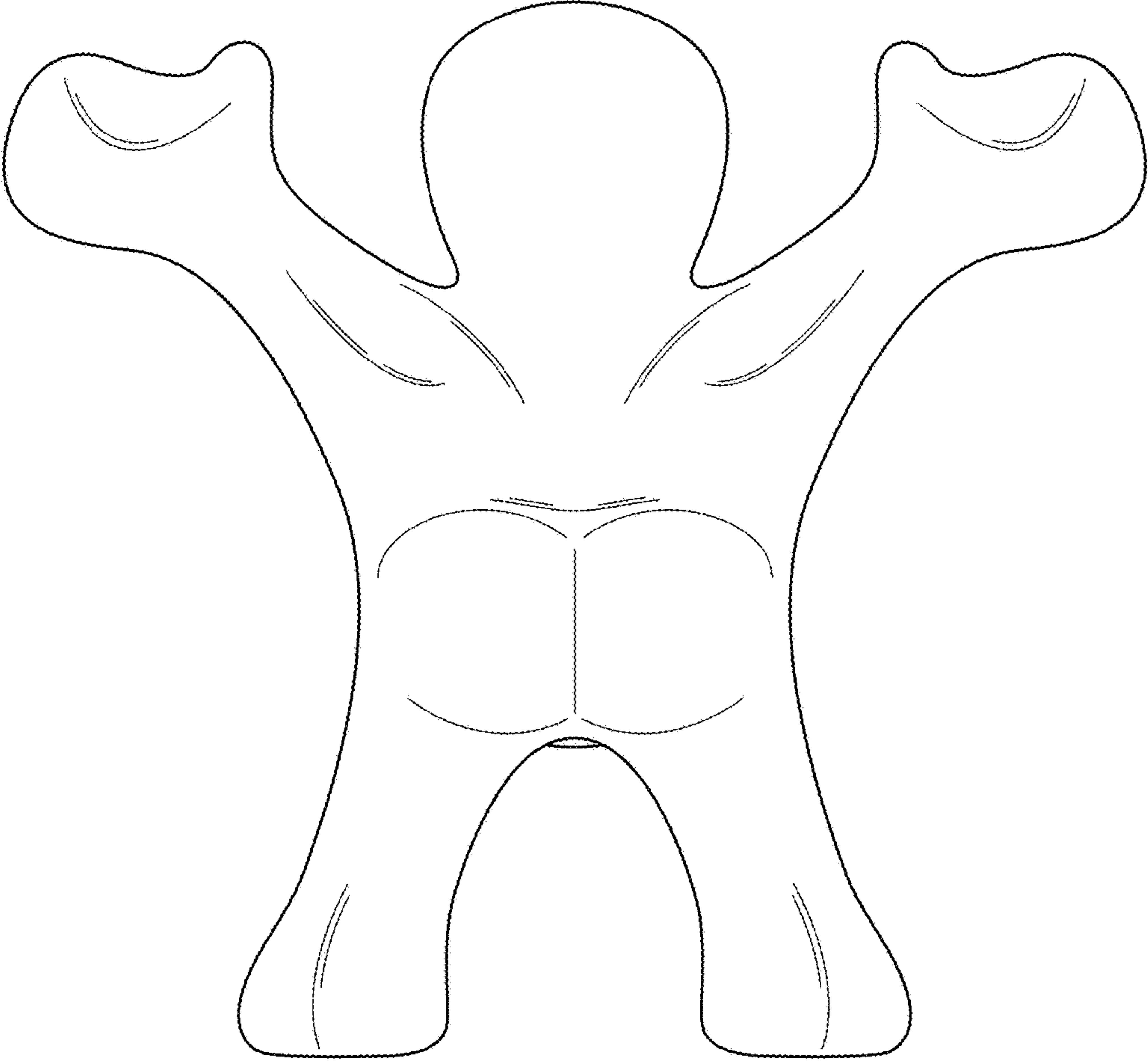

FIG. 3

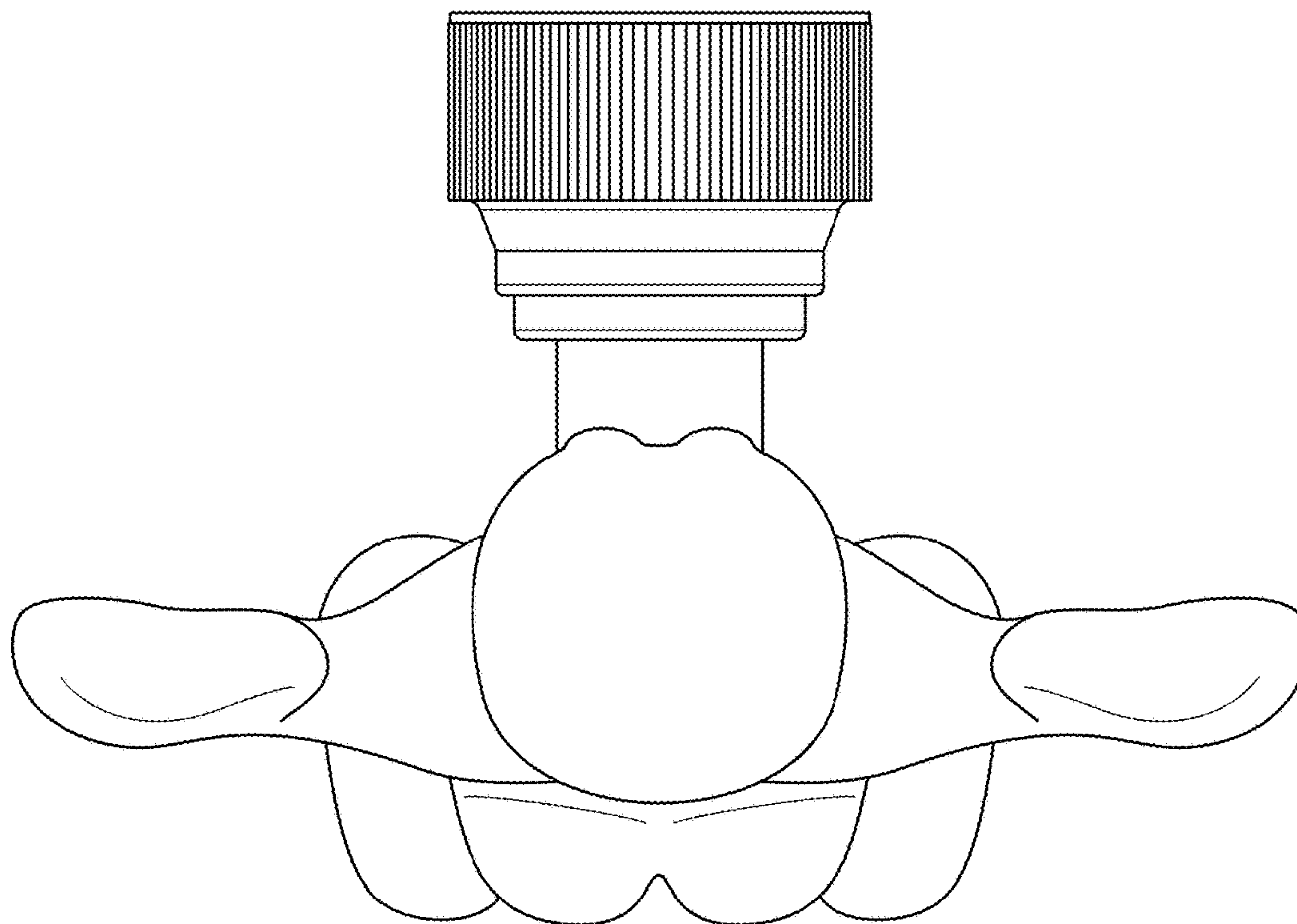

FIG. 4

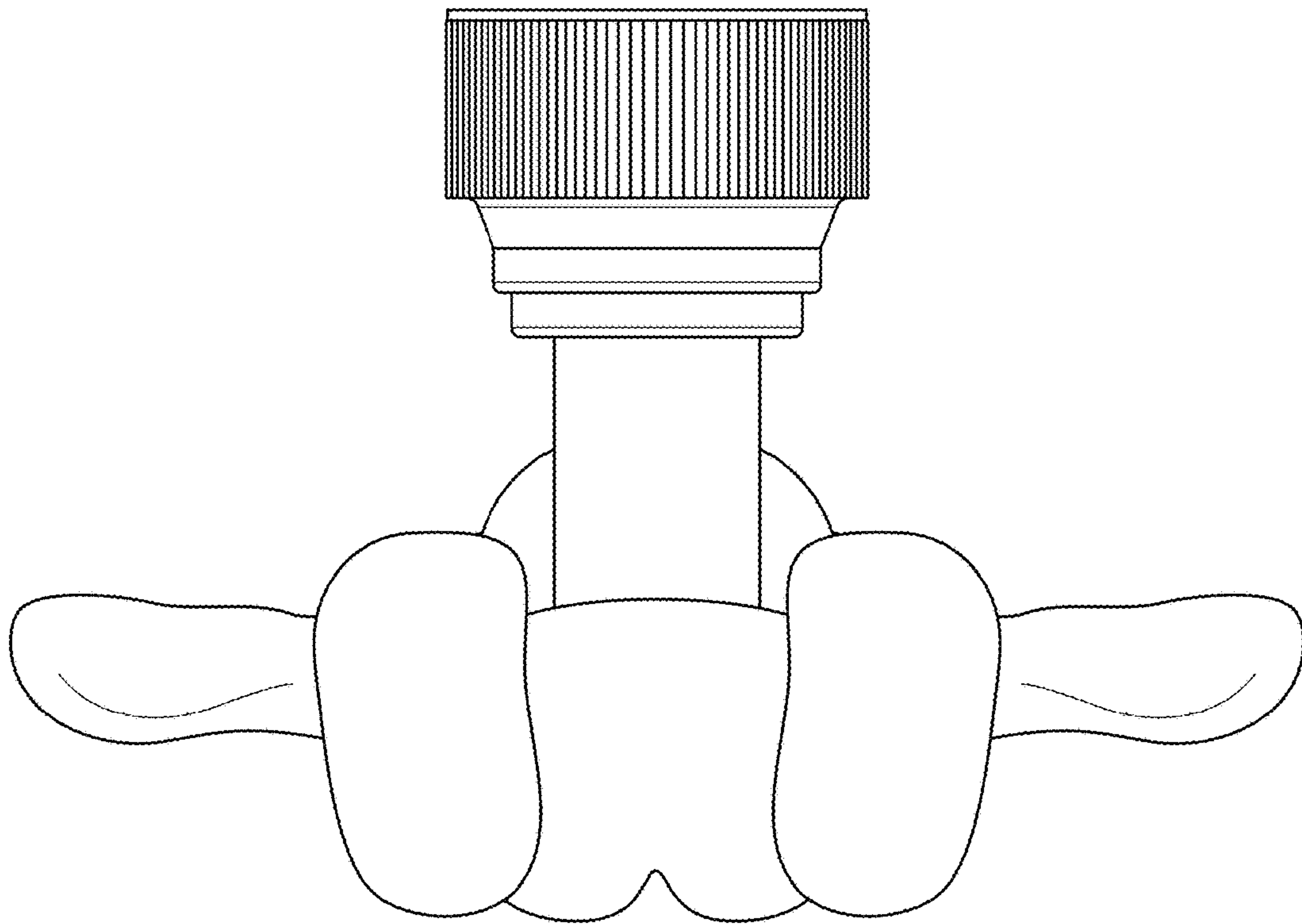

FIG. 5

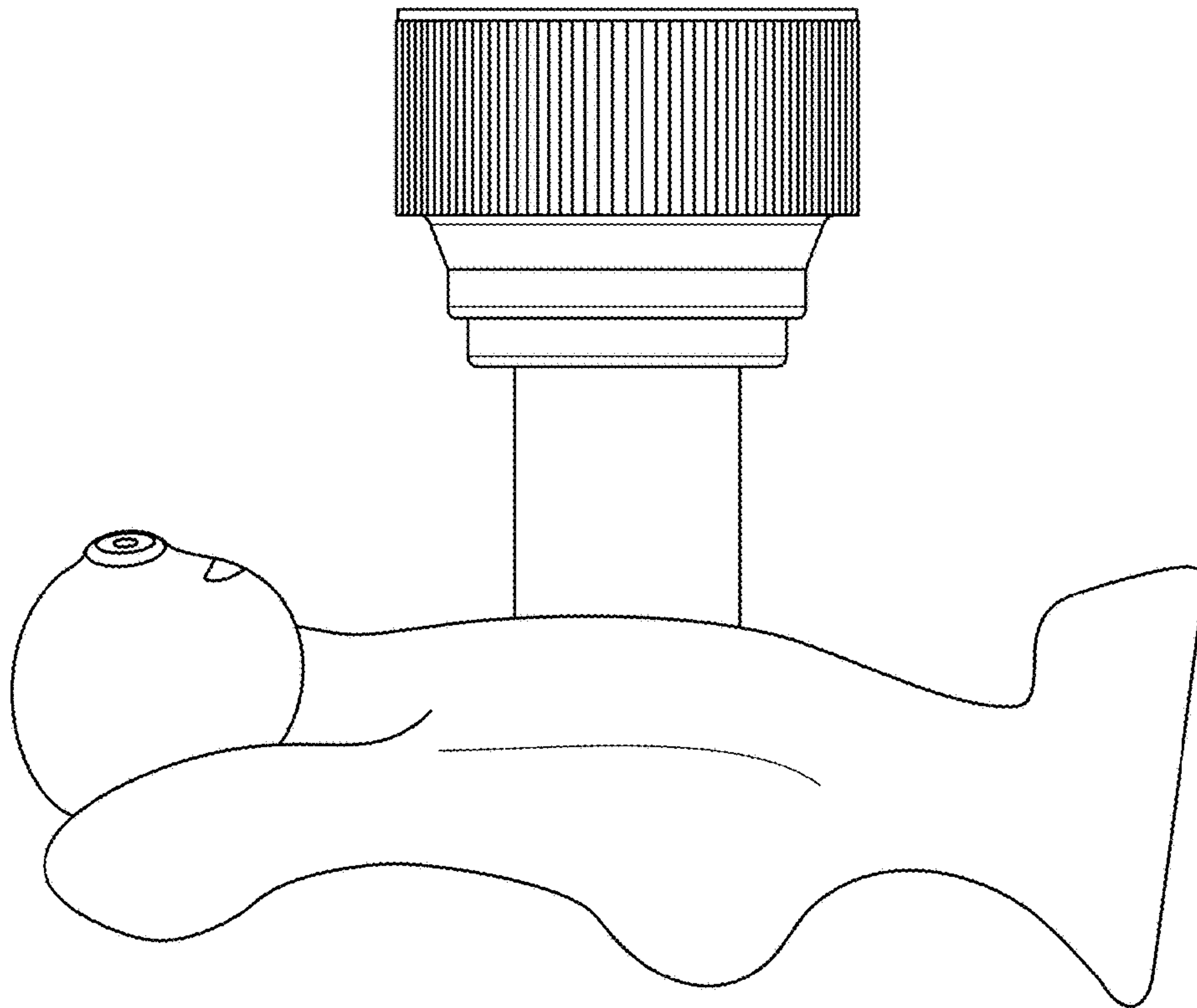

FIG. 6

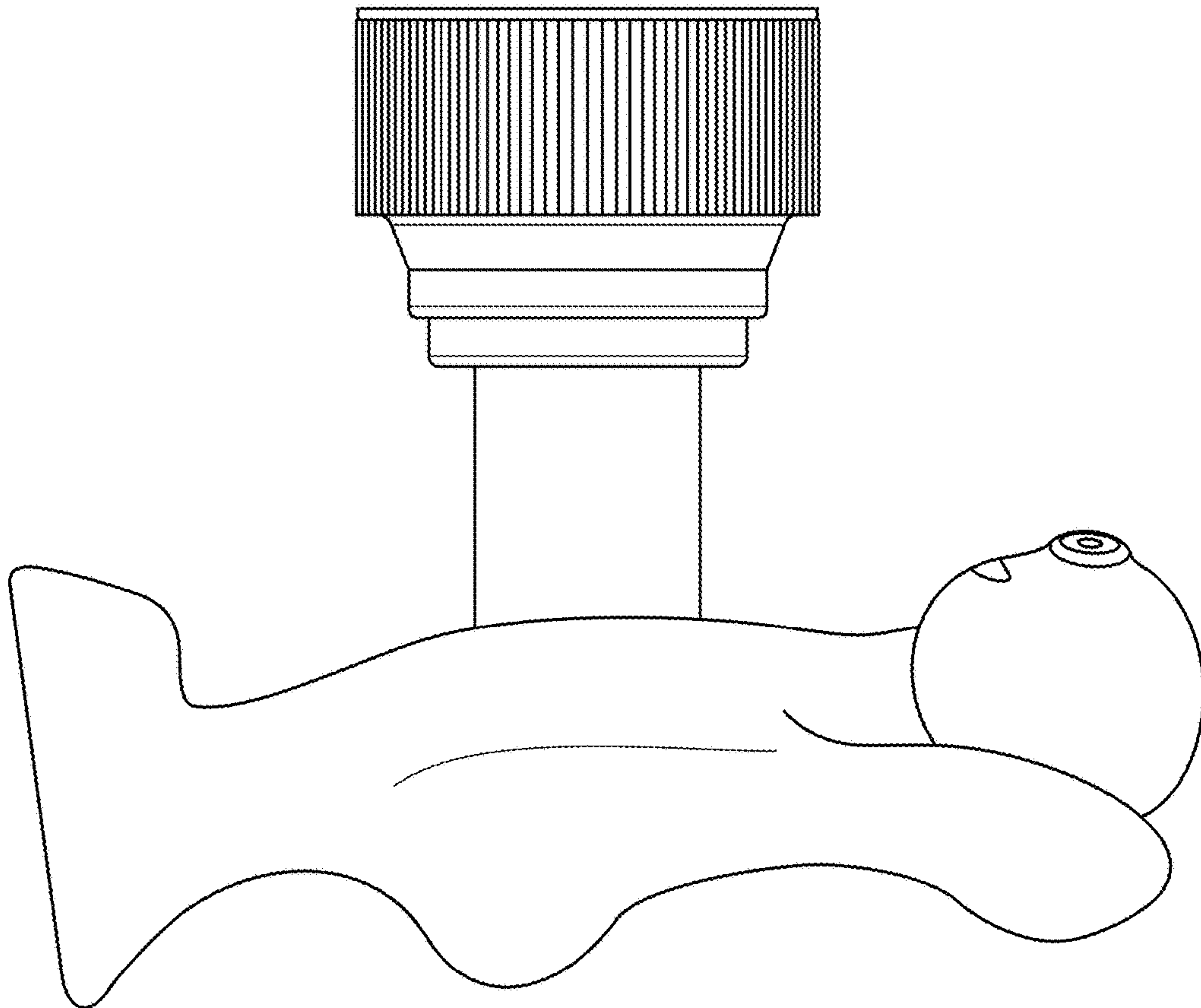

FIG. 7